



Fluke 700 Series Pressure Modules

Application Note

Because pressure is one of the more widely measured parameters in process industries, it is a critical function of a documenting process calibrator. Fluke's pressure modules cover a wide range of pressures and maintain accuracy over a wide temperature range, from 0°C to 50°C (32° F to 122°F). The pressure measurement portion of the Fluke 700 Series Documenting Process Calibrators is separate from the main unit to facilitate connection to fixed or bulky equipment and to provide multiple pressure ranges for a single calibrator.

A large selection of gage and differential modules

A family of 27 pressure modules covers the most common pressure calibrations from 0-10" H₂O (0-2.5 kPa) to 0-10,000 psi (0-70,000 kPa).

Gage pressure modules have one pressure fitting and measure the process pressure with respect to atmospheric pressure. Differential pressure modules have two pressure fittings and measure the difference between the applied pressure on the high fitting versus the low fitting. Each module is clearly labeled for range, overpressure specification, and materials compatibility. A metric adapter is included with all but the P29 through P31 high pressure modules. Figure 1 shows the two types.

Quick and easy measurements

Fluke 700 Series pressure modules are easy to operate. To measure pressure, the technician disconnects the pressure measuring transmitter from the process, plumbs the pressure module to a pressure source, and connects the pressure module cable to the calibrator. Pressure

is applied, measured by the pressure module, and displayed digitally on the calibrator. At the touch of a button, the pressure may be displayed in any of 10 different pressure units. Because the 700 Series calibrators can capture readings electronically, there's no need to write down results. The calibrators automatically time-stamp and store all saved measurements, saving time, and eliminating errors associated with making manual notations in the field. These self-documenting capabilities are important in ensuring accurate maintenance. They are also very helpful in collecting calibration data to support compliance with documentation standards, including those established by OSHA, the FDA, the EPA, and ISO 9000.

Pressure module performance

Fluke 700 Series pressure modules are highly accurate, with simply stated specifications that apply from 0% to 100% of full span and from 0°C to 50°C (32°F to 122°F)—a factor that sets them apart from other pressure calibrators. Most ranges have total uncertainties of 0.05% of full scale (see Table 1, page 2).

This performance is possible through the innovative application of mathematics and micro-processor power. Fluke pressure modules have silicon piezoresistor sensors which consist of a resistive bridge fabricated in a silicon diaphragm. Pressure applied to the diaphragm causes a change in the balance of the bridge which is proportional to the applied pressure. The bridge balance change is not linear and is very sensitive to temperature. However, since these effects are quite stable with time and through repetitive changes of condition, the sensors can be very accurate in measuring pressure over a wide temperature range, provided they are carefully characterized.

During manufacture, Fluke pressure modules are characterized by reading temperature and pressure at more than 100 points. A least-squares regression is used to calculate the coefficients of polynomial expression for pressure. The coefficients, unique to that pressure module, are stored in the module's memory.

Figure 1. Gage and Differential pressure modules



Each module has its own microprocessor, allowing it to run the measurement circuitry and to communicate digitally with the calibrator. When connected to the calibrator, the coefficients are uploaded from the pressure module to the calibrator. Then, when pressure measurements are made, raw sensor values for pressure and temperature are digitally loaded to the calibrator, where the raw sensor values and coefficients are manipulated to derive and display the pressure reading. This innovative technique provides several benefits:

1. Digital communication eliminates errors due to poor connections and electrical interference.
2. The modules are inherently temperature-compensated from 0°C to 50°C (32°F to 122°F), with no derating for temperature effects.

3. The modules are fully interchangeable because all signal processing is handled in the pressure module itself and then communicated to the calibrator in digitized form. Modules are calibrated independently of the calibrator, and can be used with any 700 Series calibrator. Each module has its own serial number to facilitate traceability.

Sensor protection in isolated modules

Many of these modules (see Table 1) incorporate a stainless steel diaphragm to isolate the sensor. With these modules, any medium that is compatible with stainless steel can be used on the high side of the module.

Rugged construction

The pressure modules are designed to operate accurately and reliably despite the rough handling and harsh environmental conditions often found in process plants. A urethane overmolding protects against shock if a module is accidentally dropped and also seals against dirt, dust, and moisture. The module case is held together with screws connected to brass-reinforced seats, and all the pressure fittings, which are constructed of 316 stainless steel, have internal mechanical supports. Pressure connections are 1/4" NPT. A BSP/ISO adapter is also provided on all but the P29, P30 and P31.

Small and lightweight

Since process technicians might need to carry two or more pressure modules along with the calibrator, the modules are small and lightweight.

Remote sensor

A one-meter cable between the pressure module and calibrator reduces the length of connecting tubing to the pressure source. The remote pressure head also provides an extra margin of safety and convenience by removing the calibrator and operator from the pressure source.



Figure 2. 700 Series Pressure Modules are overmolded with protective urethane and sealed against dirt, dust and moisture. All fittings are made of 316 stainless steel or Hastelloy C276 and have internal mechanical supports

Table 1. Pressure specifications

Model	Range/Resolution	Range (approx)/Resolution	Typical uncertainty 1 year	Total ¹ uncertainty 1 year	High ² side media	Low ² side media	Fitting material	Max over-pressure (x nominal)
Differential								
FLUKE-700P01	10 in. H ₂ O / 0.01	2.5 kPa / 0.002	0.10%	0.30%	Dry	Dry	316 SS	3x
FLUKE-700P02	1 psi / 0.0001	6900 Pa / 0.7	0.10%	0.30%	Dry	Dry	316 SS	3x
FLUKE-700P22	1 psi / 0.0001	6900 Pa / 0.7	0.05%	0.15%	316 SS	Dry	316 SS	3x
FLUKE-700P03	5 psi / 0.0001	34 kPa / 0.001	0.04%	0.10%	Dry	Dry	316 SS	3x
FLUKE-700P23	5 psi / 0.0001	34 kPa / 0.001	0.02%	0.05%	316 SS	Dry	316 SS	3x
FLUKE-700P04	15 psi / 0.001	103 kPa / 0.01	0.03%	0.07%	Dry	Dry	316 SS	3x
FLUKE-700P24	15 psi / 0.001	103 kPa / 0.01	0.02%	0.05%	316 SS	Dry	316 SS	3x
Gage								
FLUKE-700P05	30 psi / 0.001	207 kPa / 0.01	0.02%	0.05%	316 SS	N/A	316 SS	3x
FLUKE-700P06	100 psi / 0.01	690 kPa / 0.07	0.02%	0.05%	316 SS	N/A	316 SS	3x
FLUKE-700P07	500 psi / 0.01	3400 kPa / 0.1	0.02%	0.05%	316 SS	N/A	316 SS	3x
FLUKE-700P08	1000 psi / 0.1	6900 kPa / 0.7	0.02%	0.05%	316 SS	N/A	316 SS	3x
FLUKE-700P09	1500 psi / 0.1	10 MPa / 0.001	0.02%	0.05%	316 SS	N/A	316 SS	2x
Absolute (not compatible with Fluke 701 or 702)								
FLUKE-700PA3	5 psi / 0.0001	34 kPa / 0.001	0.03%	0.07%	316 SS	N/A	316 SS	3x
FLUKE-700PA4	15 psi / 0.001	103 kPa / 0.01	0.02%	0.05%	316 SS	N/A	316 SS	3x
FLUKE-700PA5	30 psi / 0.001	207 kPa / 0.01	0.02%	0.05%	316 SS	N/A	316 SS	3x
FLUKE-700PA6	100 psi / 0.01	690 kPa / 0.07	0.02%	0.05%	316 SS	N/A	316 SS	3x
Vacuum (not compatible with Fluke 701 or 702)								
FLUKE-700PV3	-5 psi / 0.0001	-34 kPa / 0.001	0.02%	0.05%	316 SS	Dry	316 SS	3x
FLUKE-700PV4	-15 psi / 0.001	-103 kPa / 0.01	0.02%	0.05%	316 SS	Dry	316 SS	3x
Dual								
FLUKE-700PD2	±1 psi / 0.0001	±6900 Pa / 0.7	0.07%	0.20%	316 SS	Dry	316 SS	3x
FLUKE-700PD3	±5 psi / 0.0001	±34 kPa / 0.001	0.03%	0.07%	316 SS	Dry	316 SS	3x
FLUKE-700PD4	±15 psi / 0.001	±103 kPa / 0.01	0.03%	0.07%	316 SS	Dry	316 SS	3x
FLUKE-700PD5	-15/30 psi / 0.001	-100/206 kPa / 0.01	0.03%	0.07%	316 SS	N/A	316 SS	3x
FLUKE-700PD6	-15/100 psi / 0.01	-100/690 kPa / 0.07	0.03%	0.07%	316 SS	N/A	316 SS	3x
FLUKE-700PD7	-15/200 psi / 0.01	-100/1380 kPa / 0.1	0.03%	0.07%	316 SS	N/A	316 SS	3x
High								
FLUKE-700P29	3000 psi / 0.1	20.6 M Pa / 0.001	0.04%	0.10%	C276	N/A	C276	2x
FLUKE-700P30	5000 psi / 0.1	34 M Pa / 0.001	0.04%	0.10%	C276	N/A	C276	2x
FLUKE-700P31	10000 psi / 1	69 M Pa / 0.007	0.04%	0.10%	C276	N/A	C276	1.5x

¹Total uncertainty, % of full span for temperature range 0°C to +50°C, one year interval. Total uncertainty, 1.0% of full span for temperature range -10°C to 0°C, one year interval.

²"Dry" indicates dry air or non-corrosive gas as compatible media. "316 SS" indicates media compatible with Type 316 Stainless Steel. "C276" indicates media compatible with Hastelloy C276.

Use of pressure zero is required prior to measurement or source.

Pressure units available are: psi, kPa, bar, in. Hg, mm Hg, in. H₂O (@4°C), ft. H₂O (@4°C), kg/cm², in. H₂O (@60°F), mm. H₂O (@4°C).

Maximum overpressure specification includes common mode pressure.

Modules are C_z rated.

Metric adapter(s): 1/4" NPT female to male BSP/ISO 1/4-19, tapered thread, included with all modules except P29, P30, and P31.

Effective October 1996, all modules include a NIST traceable certificate and test data.

Notes for 701 and 702 users only: Internal software V1.3 or later required. kg/cm², in. H₂O (@60°F), mm H₂O units not available.

Not compatible with the PA and PV modules. Resolution in inches H₂O and kPa may vary from that shown in table.

Documentation of results

The scheduling of calibration, creation of procedures and documentation of your calibration results are facilitated by a number of instrumentation management software packages:

- Fluke DPC/TRACK™
-  Cornerstone Cal Station and Base Station
The Open Platform for Instrument Management
- Honeywell Loveland™ InstruMint and DocuMint
- Sand Cove™ Instrumentation Manager
- beamex™ QM6 Quality Manager Calibration Software

DPC/TRACK is a trademark of Fluke Corporation. Cornerstone is a trademark of Applied System Technologies. InstruMint and DocuMint are trademarks of Honeywell. Sand Cove is a trademark of Digital Products Limited. QM6 is a trademark of Oy Beamex Ab.

Typical Applications

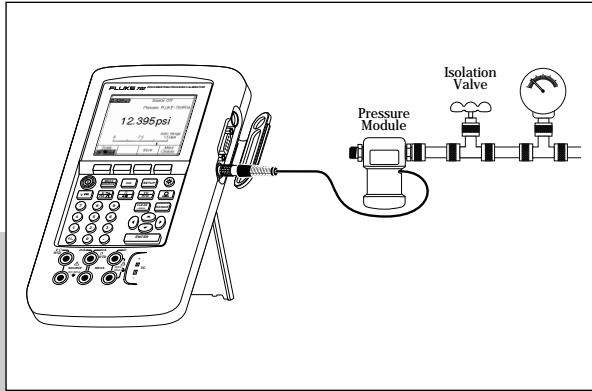

Figure 3. Typical configuration for measuring pressure.

Measuring pressure

To measure pressure, the appropriate pressure module for the pressure to be tested is attached to the calibrator. The measured pressure can be displayed in psi, mmHg, inHg, inH₂O, ftH₂O, bar, kPa or mH₂O.

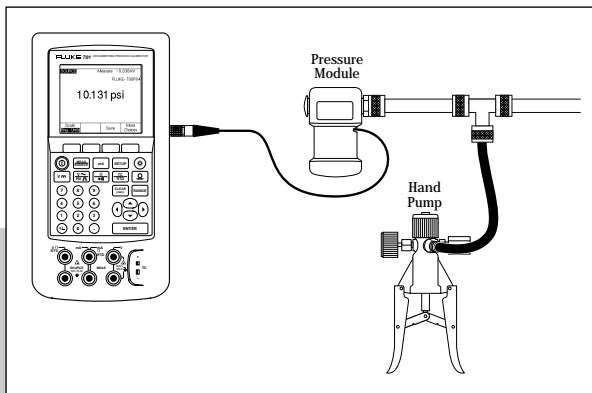

Figure 4. Typical configuration for sourcing pressure.

Sourcing pressure

To calibrate an instrument with pressure input, pressure from an external source (such as a hand-held pump) is applied. Prompts on the display indicate when to increase or decrease the input pressure, and when the specified test points are achieved.

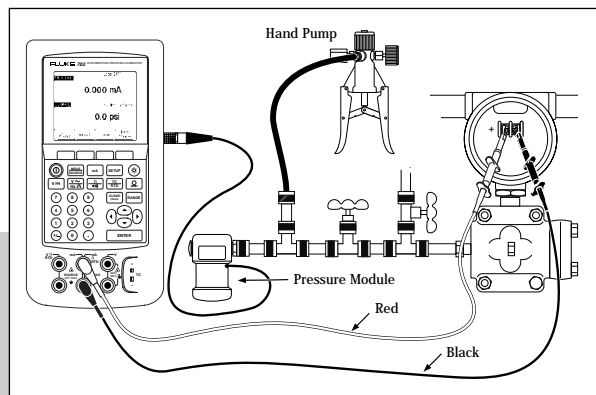

Figure 5. Typical configuration for using a pressure module to calibrate a P to I device.

P to I device calibration

The P to I device is used to convert pneumatic analog loop control signals of 3 psi to 15 psi to electrical loop analog control signals of 4 mA to 20 mA.

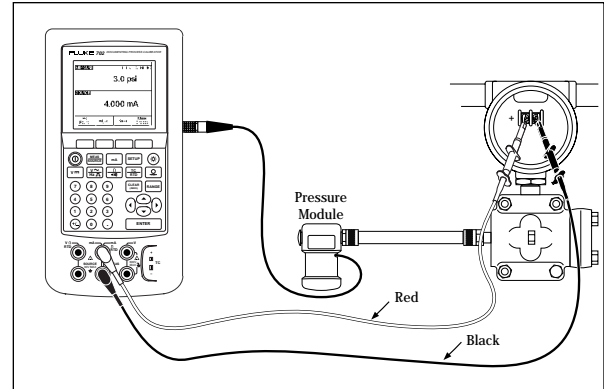

Figure 6. Typical configuration for using a pressure module to calibrate an I to P device.

I to P device calibration

The I to P device is used to convert electrical loop analog control of 4 mA to 20 mA to pneumatic analog loop control, generally 3 psi to 15 psi.

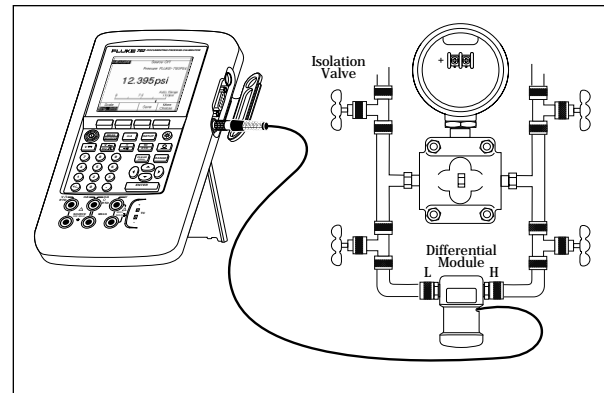

Figure 7. Typical configuration for differential pressure measurement.

Differential measurements

Differential pressure modules are useful in a wide variety of applications, e.g., measuring the fluid level in a tank or calibrating a differential pressure transmitter.

Terminology

Absolute pressure—absolute pressure measurements are referenced to zero pressure, (a perfect vacuum.)

Absolute pressure transducer—a transducer that has an internal reference chamber sealed at or close to zero pressure (full vacuum) when exposed to atmosphere a reading of approximately 14.7 psi results.

Boyle's Law—the volume of a gas is inversely proportional to the pressure of the gas at constant temperature: $V=1/P$.

Common mode pressure—the underlying common pressure (or static pressure) within a system from which a differential measurement is being made.

D/P: Differential pressure, (pronounced DP)—other names used to mean the same thing are d/p cell, d/p transmitter and ΔP transmitter (where Δ is delta or differential). This is the most common type of transmitter used in most process industries. It can be used to measure level, flow, pressure, differential pressure, and density or specific gravity. With some modifications, it can measure such things as temperature and oxygen purity. The d/p transmitter can be pneumatic, electromechanical, or solid state. It can also be a smart transmitter. A typical large process plant can have hundreds or thousands of d/p transmitters in service.

Gage pressure—the pressure relative to atmospheric pressure. Gage pressure = absolute pressure minus one atmosphere.

Gage pressure transducer—a transducer that measures pressure relative to atmospheric pressure.

Ideal Gas Law—combining Boyle's Law and Charles' Law, results in the Ideal Gas Law: $PV=nrT$, where nr is constant for a particular gas analogous to the number of molecules and the relative size of the molecule.

I/P (I to P)—a current to pressure transmitter. A common instrument in modern industrial plants. A typical large paper mill or refinery could have 5,000 I/Ps in use.

Line pressure—the maximum pressure in the pressure vessel or pipe for differential pressure measurement.

Orifice plate—a very low cost and common primary sensing element (PSE) for measuring flow. It must be used in conjunction with a d/p cell. It creates a venturi and a resulting P is developed across the plate whose square root is proportional to flow.

P/I (P to I)—a pressure to current transducer.

Pneumatic relay—refers to a pneumatic instrument that performs a function to its input and provides the result on its output (Example: square root extractor, adder, etc.).

PSI—pounds per square inch (same as psig).

PSIA—pounds per square inch absolute.

PSID—pounds per square inch differential.

PSIG—pounds per square inch gage (same as psi).

Square root extractor—an instrument or software program that takes the square root of input and puts the result on its output. Square root extraction is needed to linearize many flow signals. Example: orifice plates, venturis, target flow meters, and pitot tubes all require the transmitter's output signal to be linearized. Mag flow meters, turbine flow meters, Doppler flow meters, and vortex shedding flow meters don't require square root extraction.

Static pressure—the zero-velocity pressure at any arbitrary point within a system.

Wet/dry differential—a differential pressure transducer or transmitter that uses a metal diaphragm at the wet port where fluids can be applied, and no diaphragm at the dry port. The dry port exposes the sensor material to the medium, so only clean dry gas can be applied to this port.

Wetted parts—the diaphragm and pressure port material that comes in direct contact with the medium (gas, liquid).

Fluke-700 PCK Calibration Kit

The Fluke 700PCK Pressure Calibration Kit makes it possible to calibrate your pressure modules at your facility using your own precision pressure standards. The kit consists of a power supply, an interface adapter, appropriate cables, and Fluke 700PC Pressure Module Calibration software. When installed on your PC, the Windows®-based software easily steps you through an as-found verification, a calibration adjustment, and an as-left verification. Calibration data is captured for import to your database. A 386 or better PC, running Windows 3.1, is required, along with a precision pressure standard with an uncertainty of less than 1/4 that of the pressure module being verified.

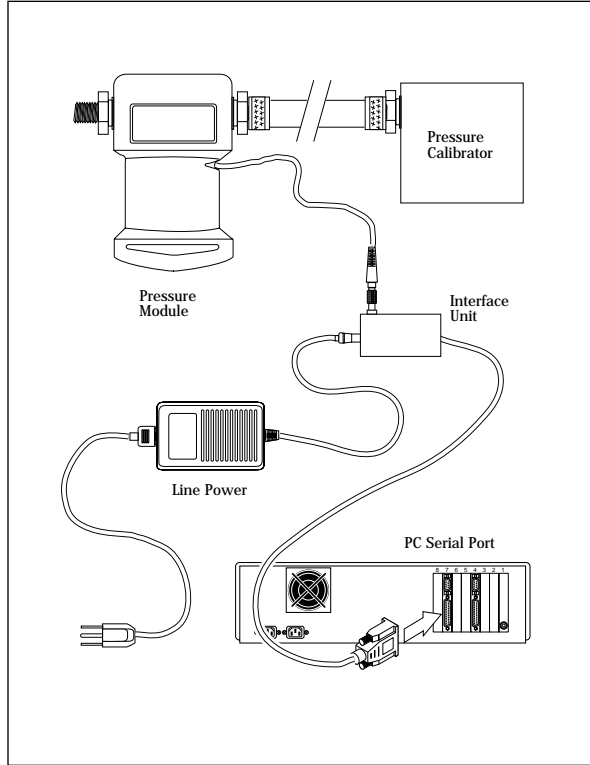

Figure 8. Calibration kit configuration.

Fluke-700 PMP Pressure Pump

This hand operated pressure pump can provide pressures up to approximately 150 psi (1000 kPa) for calibration and troubleshooting of pressure instrumentation.

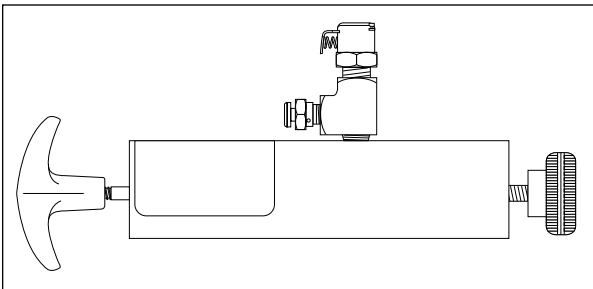

Figure 9. Pressure pump

Fluke. Keeping your world up and running.



Fluke Corporation
 PO Box 9090, Everett, WA USA 98206
 Fluke Europe B.V.
 PO Box 1186, 5602 BD
 Eindhoven, The Netherlands
 For more information call:
 U.S.A. (800) 443-5853 or
 Fax (425) 356-5116
 Europe/M-East (31 40) 2 678 200 or
 Fax (31 40) 2 678 222
 Canada (905) 890-7600 or
 Fax (905) 890-6866
 Other countries (425) 356-5500