



Advanced Test Equipment Corp.

www.atecorp.com 800-404-ATEC (2832)

**FLUKE®**

# **724/725**

Calibrators

## Calibration Manual

PN 667581

September 1999 Rev.1, 3/00

© 1999, 2000 Fluke Corporation. All rights reserved. Printed in USA  
All product names are trademarks of their respective companies.

## LIMITED WARRANTY AND LIMITATION OF LIABILITY

Each Fluke product is warranted to be free from defects in material and workmanship under normal use and service. The warranty period is three years and begins on the date of shipment. Parts, product repairs, and services are warranted for 90 days. This warranty extends only to the original buyer or end-user customer of a Fluke authorized reseller, and does not apply to fuses, disposable batteries, or to any product which, in Fluke's opinion, has been misused, altered, neglected, contaminated, or damaged by accident or abnormal conditions of operation or handling. Fluke warrants that software will operate substantially in accordance with its functional specifications for 90 days and that it has been properly recorded on non-defective media. Fluke does not warrant that software will be error free or operate without interruption.

Fluke authorized resellers shall extend this warranty on new and unused products to end-user customers only but have no authority to extend a greater or different warranty on behalf of Fluke. Warranty support is available only if product is purchased through a Fluke authorized sales outlet or Buyer has paid the applicable international price. Fluke reserves the right to invoice Buyer for importation costs of repair/replacement parts when product purchased in one country is submitted for repair in another country.

Fluke's warranty obligation is limited, at Fluke's option, to refund of the purchase price, free of charge repair, or replacement of a defective product which is returned to a Fluke authorized service center within the warranty period.

To obtain warranty service, contact your nearest Fluke authorized service center to obtain return authorization information, then send the product to that service center, with a description of the difficulty, postage and insurance prepaid (FOB Destination). Fluke assumes no risk for damage in transit. Following warranty repair, the product will be returned to Buyer, transportation prepaid (FOB Destination). If Fluke determines that failure was caused by neglect, misuse, contamination, alteration, accident, or abnormal condition of operation or handling, including overvoltage failures caused by use outside the product's specified rating, or normal wear and tear of mechanical components, Fluke will provide an estimate of repair costs and obtain authorization before commencing the work. Following repair, the product will be returned to the Buyer transportation prepaid and the Buyer will be billed for the repair and return transportation charges (FOB Shipping Point).

THIS WARRANTY IS BUYER'S SOLE AND EXCLUSIVE REMEDY AND IS IN LIEU OF ALL OTHER WARRANTIES, EXPRESS OR IMPLIED, INCLUDING BUT NOT LIMITED TO ANY IMPLIED WARRANTY OF MERCHANTABILITY OR FITNESS FOR A PARTICULAR PURPOSE. FLUKE SHALL NOT BE LIABLE FOR ANY SPECIAL, INDIRECT, INCIDENTAL OR CONSEQUENTIAL DAMAGES OR LOSSES, INCLUDING LOSS OF DATA, ARISING FROM ANY CAUSE OR THEORY.

Since some countries or states do not allow limitation of the term of an implied warranty, or exclusion or limitation of incidental or consequential damages, the limitations and exclusions of this warranty may not apply to every buyer. If any provision of this Warranty is held invalid or unenforceable by a court or other decision-maker of competent jurisdiction, such holding will not affect the validity or enforceability of any other provision.

Fluke Corporation  
P.O. Box 9090  
Everett, WA 98206-9090  
U.S.A.

Fluke Europe B.V.  
P.O. Box 1186  
5602 BD Eindhoven  
The Netherlands

# Table of Contents

Title	Page
Introduction .....	1
Read First – Safety Information .....	2
International Symbols.....	3
Specifications .....	4
DC Voltage Measurement.....	4
DC Voltage Source .....	4
DC mA Measurement and Source (Measurement only for 724) .....	4
Ohms Measurement .....	4
Ohms Source .....	5
Frequency Measurement (725 only) .....	5
Frequency Source (725 only).....	5
Millivolt Measurement and Source.....	5
Temperature, Thermocouples .....	6
Temperature, RTD Ranges, and Accuracies .....	7
Loop Power Supply .....	7
Pressure Measurement (725 only).....	7
Pressure Units Availability (725 only) .....	8
General Specifications .....	8
Cleaning the Calibrator .....	9
Self-Resetting Fuses .....	9
Replacing the Batteries.....	10
Remote Control Interface (725 only) .....	11
Required Equipment.....	14
Performance Tests .....	15
Preparing for the Performance Tests.....	15
Upper Display Voltage Measurement Tests .....	16
Lower Display mV Measurement Tests.....	17
Lower Display Voltage Measurement Tests.....	18
Upper Display mA Measurement Tests .....	19
Lower Display mA Measurement Tests (725 only).....	20
Lower Display Frequency Measurement Test (725 only) .....	21
Lower Display Frequency Source Test (725 only).....	22
Lower Display 4-Wire Resistance Measurement Tests .....	23
Lower Display 4-Wire RTD Measurement.....	24
Lower Display 3-Wire RTD Measurement.....	25
Lower Display Thermocouple Measurement Tests .....	26
Lower Display Thermocouple Source Tests.....	27
Lower Display mA Source Tests (725 only) .....	28
Lower Display mV Source Tests .....	29
Lower Display Voltage Source Tests .....	29

Lower Display Ohms Source Tests.....	30
Pressure Module Input .....	31
Calibration Adjustment Procedures .....	32
Setup.....	32
Initiating Communication .....	33
Cal Volts Input .....	34
Cal Volts Output .....	35
Cal mA Input (Fluke 725 Only) .....	36
Cal mA Output (Fluke 725 Only) .....	37
Cal mV Input.....	38
Cal mV Output .....	39
Cal Thermocouples .....	40
Cal Ohms Hi Source.....	41
Cal Ohms Low Source .....	42
Cal RTD Low Range.....	43
Cal RTD Hi Range .....	44
Cal ISO Volts .....	45
Cal ISO mA .....	46
Replaceable Parts .....	47

# List of Tables

Table	Title	Page
1.	International Symbols .....	3
2.	Upper Display Remote Commands .....	11
3.	Lower Display Remote Commands .....	12
4.	Remote Commands for Sensor Selection .....	13
5.	Required Equipment and Software .....	14
6.	Upper Display Voltage Readings .....	16
7.	Lower Display mV Readings.....	17
8.	Lower Display Voltage Readings .....	18
9.	Upper Display mA Readings .....	19
10.	Lower Display mA Readings.....	20
11.	Lower Display Frequency Source Readings.....	22
12.	Lower Display 4-Wire Resistance Readings .....	23
13.	Lower Display 4-Wire and 3-Wire RTD Temperature Readings.....	24
14.	Type J Thermocouple Readings .....	26
15.	Lower Display Thermocouple Source Readings .....	27
16.	Lower Display mA Source Readings.....	28
17.	Lower Display mV Source Readings.....	29
18.	Lower Display Voltage Source Readings.....	29
19.	Lower Display Ohms Source Readings .....	30
20.	Replacement Parts .....	47



# List of Figures

Figure	Title	Page
1.	Replacing the Batteries .....	10
2.	Upper Display Voltage Test Connections .....	16
3.	Lower Display mV and Voltage Test Connections .....	17
4.	Upper Display mA Test Connections .....	19
5.	Lower Display mA Test Connections.....	20
6.	Lower Display Frequency Test Connections.....	21
7.	Lower Display Frequency Source Test Connections.....	22
8.	Lower Display 4-Wire Resistance Test Connections .....	23
9.	Lower Display 3-Wire Resistance Test Connections .....	25
10.	Lower Display Thermocouple Test Connections .....	26
11.	Lower Display mA Source Test.....	28
12.	Lower Display Ohms Source Test Connections .....	30
13.	3 Volts Input Calibration Connections .....	34
14.	Volts Output Calibration Connections .....	35
15.	mA Input Calibration Connections .....	36
16.	mA Output Calibration Connections .....	37
17.	mV Input Calibration Connections .....	38
18.	mV Output Calibration Connections .....	39
19.	Thermocouples Calibration Connections .....	40
20.	Ohms Hi Source Calibration Connections.....	41
21.	RTD Low Range Calibration Connections .....	43
22.	ISO Volts Calibration Connections .....	45
23.	ISO mA Calibration Connections .....	46
24.	Replacement Parts .....	48





## Introduction

### Warning

**The information provided in this manual is for the use of qualified personnel only. Do not perform the verification tests or calibration procedures described in this manual unless you are qualified to do so.**

This Calibration Manual provides the following information for the Fluke 724 Temperature Calibrator and the Fluke 725 Multifunction Process Calibrators (also referred to as "the Calibrator" and/or "the UUT"):

- Precautions and safety information
- Equipment required for performance tests and calibration
- Specifications
- Basic maintenance (cleaning, batteries, and fuses)
- Instructions for using the remote control interface
- Performance test procedures
- Calibration procedures
- List of replaceable parts

For complete operating instructions, refer to the appropriate *Users Manual* (located on the CD-ROM shipped with the instrument).

### Caution

**The Calibrator contains parts that can be damaged by static discharge. No procedure in this document requires the case to be opened. If you do so, follow the standard practices for handling static sensitive devices.**

To locate an authorized service center, visit us on the World Wide Web at **www.fluke.com** or call Fluke using any of the following numbers:

- USA: 1-888-99-FLUKE (1-888-993-5853)
- Canada: 1-800-36-FLUKE (1-800-363-5853)
- Europe: +31 402-678-200
- Japan: +81-3-3434-0181
- Singapore: +65-738-5655
- Anywhere in the world: +1-425-446-5500

## Read First – Safety Information

In this calibration manual, a **Warning** identifies conditions and actions that pose hazard(s) to the user. A **Caution** identifies conditions and actions that may damage the Calibrator or the test instruments.

### Warnings

To avoid possible electric shock or personal injury:

- **DO NOT** use the Calibrator if it looks damaged.
- Follow all safety procedures for the test and calibration equipment you use.
- Examine the Calibrator before use. Look for cracks in the case, missing plastic, or damaged insulation around the connectors.
- Inspect the test leads for damaged insulation or exposed metal. Check for test lead continuity. Replace damaged test leads as necessary.
- Do not use the Calibrator if it operates abnormally. Protection may be impaired. When in doubt, have the instrument serviced.
- Do not apply more than the rated voltage, as marked on the Calibrator, between terminals or between any terminal and earth ground.
- Never touch the probes to a voltage source when the test leads are plugged into the current terminals.
- Select the proper function and range for each measurement.
- Disconnect the test leads before changing to another measure or source function.
- When using probes, keep fingers behind the finger guards on the probes.
- Use caution when working above 30 V ac rms, 42 V ac peak, or 60 V dc. Such voltages pose a shock hazard.
- Connect the common lead (COM) before connecting the live test lead. When disconnecting test leads, disconnect the live test lead first.
- Always place the 5520A calibrator in Standby (STBY) mode between tests and before handling the test connections or cables.
- Remove test leads from the Calibrator before opening the battery door.
- Do not operate the Calibrator around explosive gas, vapor, or dust.
- During normal operation, only use four properly installed AA batteries to power the Calibrator.
- Make sure the battery door is closed and latched before you operate the Calibrator.
- During calibration, use only specified calibration equipment listed in Table 2.

(Continued on the next page)

**⚠ Warnings (cont.)**

- When servicing the Calibrator, use only specified replacement parts.
- To avoid false readings, which can lead to possible electric shock or personal injury, replace the batteries as soon as the low battery indicator (🔋) appears.

**Caution**

To avoid possible damage to the Calibrator or to the test instruments:

- Disconnect the power and discharge all high voltage capacitors before testing resistance, diodes, or continuity.
- Use the proper jacks, function, and range for each measurement or sourcing application.

## International Symbols

International symbols used on the Calibrator and in this manual are explained in Table 1.

**Table 1. International Symbols**

Symbol	Meaning	Symbol	Meaning
~	Alternating current	⏏	Earth ground
⋮	Direct current	Ⓜ	ON/OFF
⤵	Alternating or direct current	CE	Conforms to European Union directives
⊙	Pressure	🔋	Battery
⚠	Refer to the manual. Important information.	CSA	Conforms to relevant Canadian Standards Association directives
⚡	Take appropriate precautions. Hazardous voltage may be present.	□	Double insulated

## Specifications

Performance and accuracy are specified for one year after calibration, at operating temperatures of +18 °C to +28 °C (64 °F to 82 °F), in relative humidity to 90 %, after a 5-minute warm up period.

### Note

A “count” is the amount by which the least significant digit can vary.

### DC Voltage Measurement

Range	Resolution	Accuracy (% of Reading + Counts)
30 V (upper display)	0.001 V	0.02 % + 2
20 V (lower display)	0.001 V	0.02 % + 2
90 mV (lower display)	0.01 mV	0.02 % + 2
Temperature coefficient -10 °C to +18 °C, 28 °C to 55 °C: ±0.005 % of range per °C		

### DC Voltage Source

Range	Resolution	Accuracy (% of Reading + Counts)
100 mV	0.01 mV	0.02 % + 2
10 V	0.001 V	0.02 % + 2
Temperature coefficient -10 °C to +18 °C, 28 °C to 55 °C: ±0.005 % of range per °C		
Maximum load: 1 mA		

### DC mA Measurement and Source (Measurement only for 724)

Range	Resolution	Accuracy ( % of Reading + Counts)
24 mA	0.001 mA	0.02 % + 2
Temperature coefficient -10 °C to +18 °C, +28 °C to 55 °C: ±0.005 % of range per °C		
Drive capability: 1000 Ω at 20 mA		

### Ohms Measurement

Ohms Range	Accuracy, 4-Wire	Accuracy*, 2-Wire, or 3-Wire
0 Ω to 400 Ω	±0.1 Ω	±0.15 Ω
400 Ω to 1.5 kΩ	±0.5 Ω	±1.0 Ω
1.5 Ω to 3.2 kΩ	±1 Ω	±1.5 Ω
Excitation Current: 0.2 mA		
Maximum input voltage: 30 V		
Temperature coefficient -10 °C to +18 °C, +28 °C to 55 °C: ±0.005 % of range per °C		
* 2-wire: Does not include lead resistance.		
3-wire: Assumes matched leads with a total resistance not exceeding 100 Ω.		

**Ohms Source**

Ohms Range	Excitation Current from Measurement Device	Accuracy
15 Ω to 400 Ω	0.15 mA to 0.5 mA	±0.15 Ω
15 Ω to 400 Ω	0.5 mA to 2 mA	±0.1 Ω
400 Ω to 1.5 kΩ	0.05 mA to 0.8 mA	±0.5 Ω
1.5 Ω to 3.2 kΩ	0.05 mA to 0.4 mA	±1 Ω
<b>Temperature coefficient -10 °C to +18 °C, 28 °C to 55 °C: ±0.005 % of resistance range per °C</b>		
<b>Resolution</b>		
15 to 400 Ω	0.1 Ω	
400 to 3.2 kΩ	1 Ω	

**Frequency Measurement (725 only)**

Range	Resolution	Accuracy
2.0 to 1000.0 CPM	0.1 CPM	± (0.05 % + 1 count)
1 to 1100 Hz	0.1 Hz	± (0.05 % + 1 count)
1.0 to 10.0 kHz	0.01 kHz	± (0.05 % + 1 count)
<b>Sensitivity: 1 V peak-to-peak minimum</b>		
<b>Waveform: Squarewave</b>		

**Frequency Source (725 only)**

Range	Resolution	Accuracy (% of output frequency)
2.0 to 1000.0 CPM	0.1 CPM	± 0.05 %
1 to 1100 Hz	1 Hz	± 0.05 %
1.0 to 10.0 kHz	0.1 kHz	± 0.25 %
<b>Waveform: 5 V p-p squarewave, -0.1 V offset</b>		

**Millivolt Measurement and Source**

Range*	Resolution	Accuracy
-10 mV to +75 mV	0.01 mV	±(0.025 % + 1 count)
<b>Maximum input voltage: 30 V</b>		
<b>Temperature coefficient -10 °C to +18 °C, 28 °C to 55 °C: ±0.005 % of range per °C</b>		
*Select this function by pressing <input type="checkbox"/> TC. The signal is available at the thermocouple miniplug connector.		

**Temperature, Thermocouples**

Type	Range (°C)	Measure and Source Accuracies (°C)
J	-200 to 0	1.0
	0 to 1200	0.7
K	-200 to 0	1.2
	0 to 1370	0.8
T	-200 to 0	1.2
	0 to 400	0.8
E	-200 to 0	0.9
	0 to 950	0.7
R	-20 to 0	2.5
	0 to 500	1.8
	500 to 1750	1.4
S	-20 to 0	2.5
	0 to 500	1.8
	500 to 1750	1.5
B	600 to 800	2.2
	800 to 1000	1.8
	1000 to 1800	1.4
L	-200 to 0	0.85
	0 to 900	0.7
U	-200 to 0	1.1
	0 to 400	0.75
N	-200 to 0	1.5
	0 to 1300	0.9
<b>Resolution:</b>		
J, K, T, E, L, N, U: 0.1 °C, 0.1 °F		
B, R, S: 1 °C, 1 °F		

**Temperature, RTD Ranges, and Accuracies**

Type	Range (°C)	Accuracy		
		Measure 4-wire (°C)	Measure* 2- and 3-wire (°C)	Source (°C)
Ni120	-80 to 260	0.2	0.3	0.2
Pt100-385	- 200 to 800	0.33	0.5	0.33
Pt100-392	-200 to 630	0.3	0.5	0.3
Pt100-JIS	-200 to 630	0.3	0.5	0.3
Pt200-385	-200 to 250	0.2	0.3	0.2
	250 to 630	0.8	1.6	0.8
Pt500-385	-200 to 500	0.3	0.6	0.3
	500 to 630	0.4	0.9	0.4
Pt1000-385	-200 to 100	0.2	0.4	0.2
	100 to 630	0.2	0.5	0.2

**Resolution:** 0.1 °C, 0.1 °F  
**Allowable excitation current (source):** Ni120, Pt100-385, Pt100-392, Pt100-JIS, Pt200-385: 0.15 to 3.0 mA, Pt500-385: 0.05 to 0.80 mA; Pt1000-385: 0.05 to 0.40 mA  
**RTD Source:** Addresses pulsed transmitters and PLCs with pulses as short as 5 ms.  
\*2-wire: Does not include lead resistance.  
3-wire: Assumes matched leads with a total resistance not exceeding 100 Ω.

**Loop Power Supply**

Voltage: 24 V

Maximum current: 22 mA

Short circuit protected

**Pressure Measurement (725 only)**

Range	Resolution	Accuracy	Units
Determined by pressure module	5 digits	Determined by pressure module	psi, inH <sub>2</sub> O@4 °C, inH <sub>2</sub> O@20 °C, kPa, cmH <sub>2</sub> O@4 °C, cmH <sub>2</sub> O@20 °C, bar, mbar, kg/cm <sub>2</sub> , mmHg, inHg

**Pressure Units Availability (725 only)**

Unit	Availability
psi	Available on all pressure ranges
inH <sub>2</sub> O	All ranges through 3000 psi
cmH <sub>2</sub> O	All ranges through 1000 psi
bar	15 psi and above
mbar	All ranges through 1000 psi
kPa	Available on all pressure ranges
inHg	Available on all pressure ranges
mmHg	All ranges through 1000 psi
kg/cm <sup>2</sup>	15 psi and above

**General Specifications**

Operating temperature	-10 °C to 55 °C
Storage temperature	- 20 °C to 71 °C
Operating altitude	3000 meters above mean sea level
Relative Humidity (% RH operating without condensation)	90 % (10 to 30 °C) 75 % (30 to 40 °C) 45 % (40 to 50 °C) 35 % (50 to 55 °C) uncontrolled < 10 °C
Vibration	Random, 2 g, 5 Hz to 500 Hz
Safety	EN 61010-1:1993, ANSI/ISA S82.01-1994; CAN/CSA C22.2 No 1010.1:1992
Power requirements	4 AA alkaline batteries
Size	96 x 200 x 47 mm (3.75 x 7.9 x 1.86 in)
Weight	650 gm (1 lb, 7 oz)



## ***Cleaning the Calibrator***

### **⚠ Warning**

**To avoid electric shock or damage to the Calibrator, never allow water inside the Calibrator's case.**

If the Calibrator requires cleaning, wipe it down with a cloth that is lightly dampened with water or a mild detergent.

Do not use aromatic hydrocarbons, chlorinated solvents, or methanol-based fluids when cleaning the Calibrator. To avoid damaging the case, never apply solvents to the Calibrator.

## ***Self-Resetting Fuses***

The Calibrator has self-resetting fuses that protect each input from overloads. The fuses open when heated by a current overload, and close when they cool down. When an input's fuse is open, the input's functions will not work.

The time required for a fuse to reset depends on the magnitude of the overload. If a fuse does not reset, return the Calibrator to an authorized service center for repair.

## Replacing the Batteries

### Warning

To avoid electric shock, remove the test leads from the Calibrator before opening the battery door. Close and latch the battery door before using the Calibrator.

To avoid false readings, which can lead to possible electric shock or personal injury, replace the batteries as soon as the low battery indicator () appears.

**When replacing the batteries, always use four new AA batteries. Never mix new and used batteries in the Calibrator.**

Four AA alkaline batteries (ANSI/NEDA 15A or IEC LR6) are used to power the Calibrator. To replace the batteries, refer to Figure 1 and do the following:

1. Turn the Calibrator off, remove the test leads from the terminals, and hold the Calibrator face down.
2. Using a flat-blade screwdriver, turn the battery door screws 1/4-turn counterclockwise and remove the battery door.
3. Remove the batteries, then install new batteries. Be sure to follow the polarity markings shown in the battery compartment.
4. Replace the battery door and secure it by turning the screws 1/4-turn clockwise.

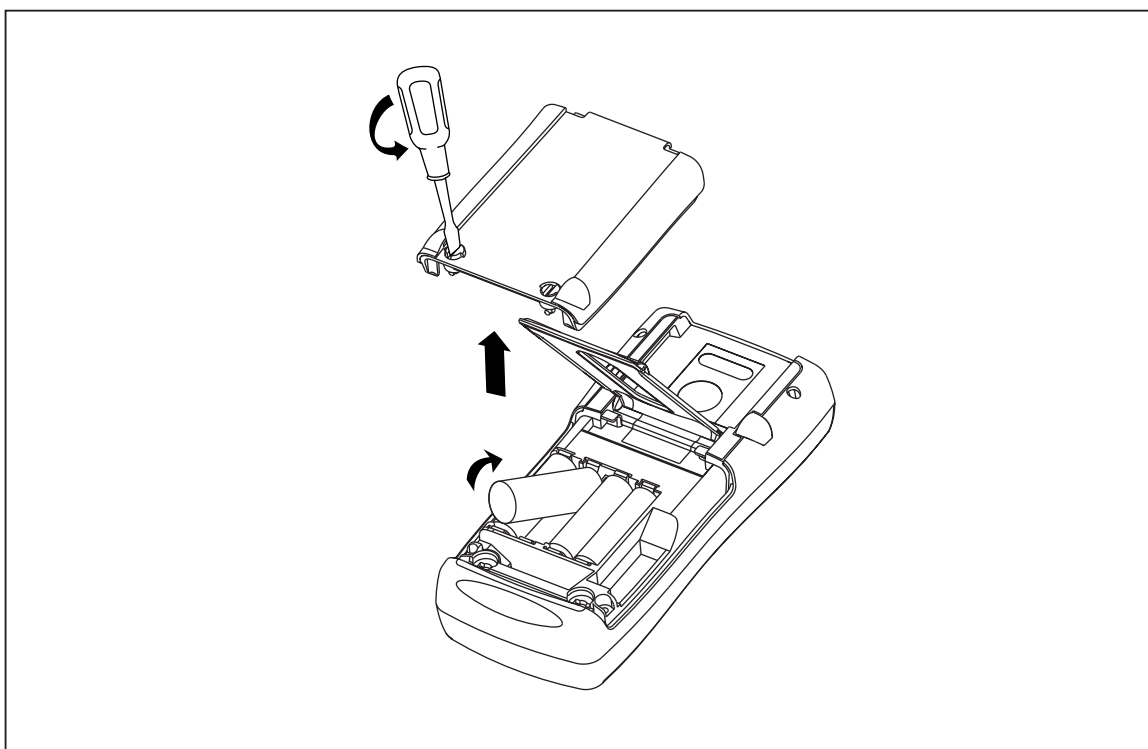



Figure 1. Replacing the Batteries

aal01f.eps

## Remote Control Interface (725 only)

The Calibrator's serial interface and remote control commands let you use a PC to remotely select Calibrator functions and read the Calibrator's display. This remote interface is especially useful if you want to write your own calibration software.

To activate the remote control interface, proceed as follows:

1. Turn off the UUT; then use the Fluke 700SC serial interface cable to connect the UUT to a serial port on the PC.
2. Start the terminal communication software on the PC. Create a new connection with the following properties:
  - Bits per second: 9600
  - Data bits: 8
  - Parity: None
  - Stop bits: 1
  - Flow control: None
  - Local echo on
3. Hold down the Calibrator's  button while turning the Calibrator on.
4. Use the commands given in Tables 2 through 4 to remotely control the Calibrator.

**Table 2. Upper Display Remote Commands**

Remote Command	Description
i	mA measurement
L	mA Loop Power
E	Voltage measurement
B	Single broadcast of the most recent upper display value and units
(	Single broadcast of most recent upper display value without header or units

Table 3. Lower Display Remote Commands

Remote Command	Description
A	mA measurement
a	mA source
I	mA 2W Sim
V	Voltage measurement
v	Voltage source
M	mV measurement
m	mV source
K	kHz measurement
k	kHz source
H	Hz measurement
h	Hz source
P	CPM measurement
p	CPM source
O	Ohms measurement (default 2W)
o	Select Ohms source
W	2-wire measurement (Ohms and RTDs)
X	3-wire measurement (Ohms and RTDs)
Y	4-wire measurement (Ohms and RTDs)
T	Thermocouple measurement (default Type J). Use "S" command to select a sensor type.
t	Thermocouple source (default Type J). Use "S" command to select a sensor type
C	Selects Centigrade ( T/C-RTD)
F	Selects Fahrenheit ( T/C-RTD)
R	RTD measurement mode (default Pt100 385). Use "S" command to select a sensor type
r	RTD measurement mode (default Pt100 385). Use "S" command to select sensor type.
u	Increment display source value
d	Decrement display source value
<	The < arrow key PC keyboard selects left arrow on 725
>	The > arrow key PC keyboard selects right arrow on 725
0-9 -, <CR>	Enter a source value using ASCII characters 0,1,2,...9,-,., terminated by <CR> (carriage return) The 725 can receive a maximum of 10 characters prior to the carriage return.
b	Single Broadcast of most recent lower display value and units
)	Single broadcast of most recent lower display value without header or units.

**Table 4. Remote Commands for Sensor Selection**

Serial Input	Selection Entry		RTD Type
	No.	Thermocouple Type	
S	1	J	Pt100 (3926)
	2	K	Pt100 (385)
	3	T	Pt100 (3916)
	4	E	Pt200 (385)
	5	R	Pt500 (385)
	6	S	Pt1000 (385)
	7	B	Ni120
	8	L	-
	9	U	-
	A	N	-
	B	mV	-

## Required Equipment

Equipment and software required to perform the procedures in this manual are identified in Table 5. If the recommended equipment model is not available, other equipment can be substituted if it meets the specifications indicated.

### Warning

**To avoid safety hazards and equipment damage during the calibration procedures, use the specified calibration equipment listed in Table 5. Using unspecified equipment can give unreliable results and pose safety hazards.**

**Table 5. Required Equipment and Software**

Equipment	Minimum Specifications	Recommended Model
Multi-Product Calibrator	DC voltage: 0 V to 30 V Accuracy: $\pm 0.005\%$  DC current: 0 mA to 24 mA Accuracy: $\pm 0.005\%$  Temperature: Type J thermocouple 90 day accuracy: $\pm 0.2\text{ }^{\circ}\text{C}$  Resistance accuracy: $\pm 0.006\%$  Frequency accuracy: $\pm 0.01\%$	Fluke Model 5520A Multi-Product Calibrator only— <i>no substitute</i>
MET/CAL <sup>®</sup> Metrology Software (see MET/CAL Installation and Upgrade Guide for minimum hardware requirements)	Version 6.0 or later	Contact Fluke for the latest version.
Digital Multimeter	DC voltage: 0 V to 24 V Accuracy: $\pm 0.0013\%$  DC voltage: 0 mA to 24 mA Accuracy: $\pm 0.005\%$	HP 3458A only— <i>no substitute</i>
Pressure Module (725 only)	In working condition; for establishing communication only	Fluke 700PXX Series
Test Leads	Two sets of stackable banana test leads	2 red leads: Fluke PN 105809 2 black leads: Fluke PN 105806
Thermocouple test lead	2 type J male miniplugs with ~12" (30.5 cm) of 20-gauge type J thermocouple wire	Fluke Model 80CJ-M male miniplugs (package of two)  20-gauge type J thermocouple wire is available through an electronic supply outlet
Personal computer	Windows <sup>®</sup> 3.1 or later with terminal communication software	486 (or later) IBM-compatible
PC interface cable (725 only)	Fluke 700SC serial interface cable assembly (LEMO to DB-9 female)	Fluke PN 667425
Calibration cable	Fluke 724/725 Calibration Cable	Fluke PN 1556747

## Performance Tests

### Warning

**Some of the performance tests involve the use of high voltages and should be performed by qualified personnel only.**

**To avoid electric shock, always set the calibration source (5520A) to Standby (STBY) mode between tests and before handling the test connections or test cables.**

Performance tests confirm the complete operability of the Calibrator and check the accuracy of each function against the Calibrator's specifications. *If the Calibrator fails any performance test, it needs calibration adjustments. If the Calibrator continues to fail after calibration adjustments, send it to an authorized Fluke Service Center for repair.*

The Calibrator's performance and accuracy are specified for one year after calibration at operating temperatures of +18 °C to +28 °C (64 °F to 82 °F), in relative humidity to 90 %. The specifications assume the Calibrator has been warmed up for five minutes before use.

It is not necessary to open the case for the performance tests; no mechanical adjustments are necessary. Merely make the required connections, source the designated values, and determine if the reading on the Calibrator or the multimeter falls within the acceptable range indicated.

### Preparing for the Performance Tests

#### Notes

*Performance tests for the Calibrator can be performed manually, or they can be computer-automated (using Fluke Metrology Software). The Metrology Software automates all of the performance verification tasks, except for connection of the standards to the Calibrator. This document provides the procedures necessary for manual performance tests. Contact Fluke for information on Metrology Software.*

*These performance tests assume that the person performing them knows how to use the Calibrator and the required equipment.*

*Do not attempt to perform these tests unless you are qualified to do so.*

*Throughout the performance tests, "UUT" (unit under test) refers to the Calibrator; the word "multimeter" is reserved for the digital multimeter identified in the required equipment listed in Table 2.*

*Unless otherwise indicated, all connection diagrams for the verification tests in this manual showing a calibrator or digital multimeter use a Fluke 5520A Calibrator or HP 3458A DMM. If you are using a different DMM, make the connections appropriate for your instrument.*

To prepare the UUT for the performance tests, do the following:

1. Make sure that you have the required equipment available. (See Table 2.)
2. Make sure the UUT has a fresh batteries. See "Replacing the Batteries" earlier in this manual.
3. Warm up the Calibrator and multimeter as required by their specifications.
4. Remove all test leads from the front of the UUT.
5. Make sure that the UUT is in a stable ambient temperature between 18 °C and 28 °C (64.4 °F and 82.4 °F) and that it has been warmed up for five minutes.

### Upper Display Voltage Measurement Tests

1. Press **RESET** on the 5520A.
2. Press  $\boxed{\text{V}_{\text{LOOP}}^{\text{mA}}}$  on the UUT until **V** appears on the upper display.
3. Make the connections shown in Figure 2.
4. Set up the 5520A to output each of the voltages in Table 6 and verify that the UUT readings are within the limits shown.
5. Press **STBY** on the 5520A.

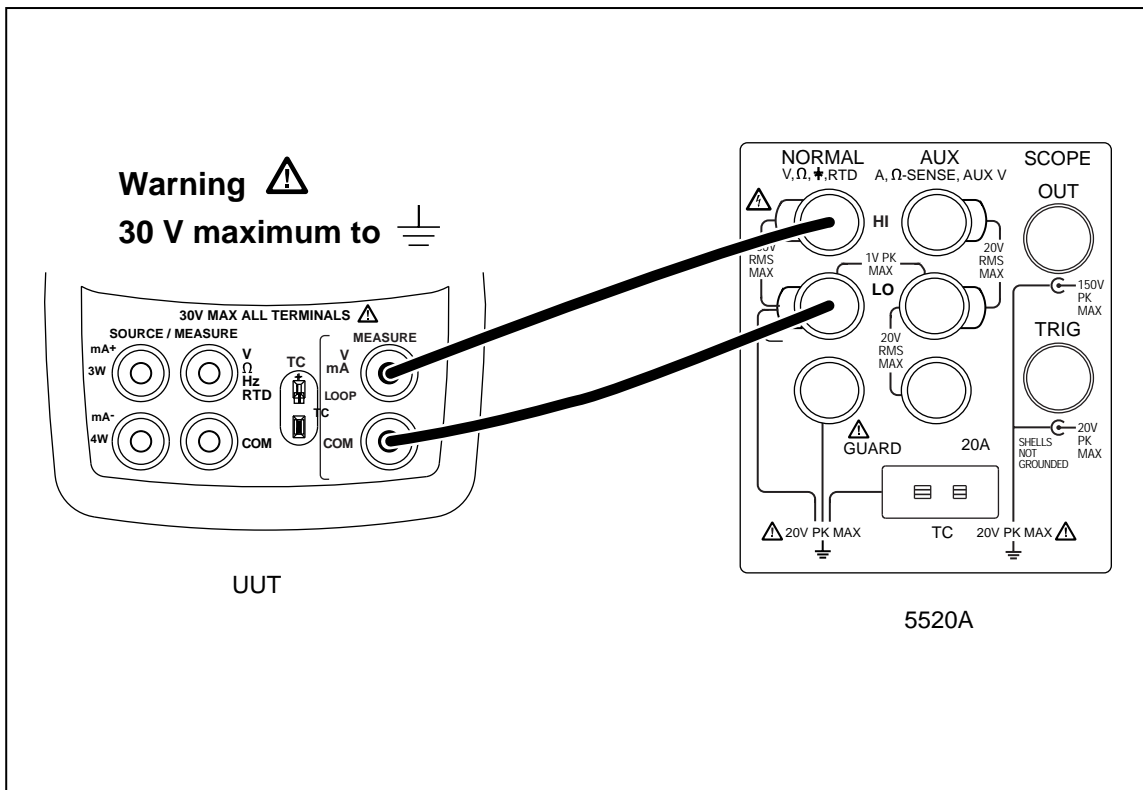

Figure 2. Upper Display Voltage Test Connections

aal03f.eps

Table 6. Upper Display Voltage Readings

5520A Outputs	UUT Readings
0.000 V	-0.002 V to +0.002 V
15.000 V	14.995 V to 15.005 V
30.000 V	29.992 V to 30.008 V



### Lower Display mV Measurement Tests

1. Press **RESET** on the 5520A.
2. Press **V mA** on the UUT until **MEASURE** and **mV** appear on the lower display.
3. Make the connections shown in Figure 3.
4. Set up the 5520A to output each of the voltages in Table 7 and verify that the UUT readings are within the limits shown.
5. Press **STBY** on the 5520A.

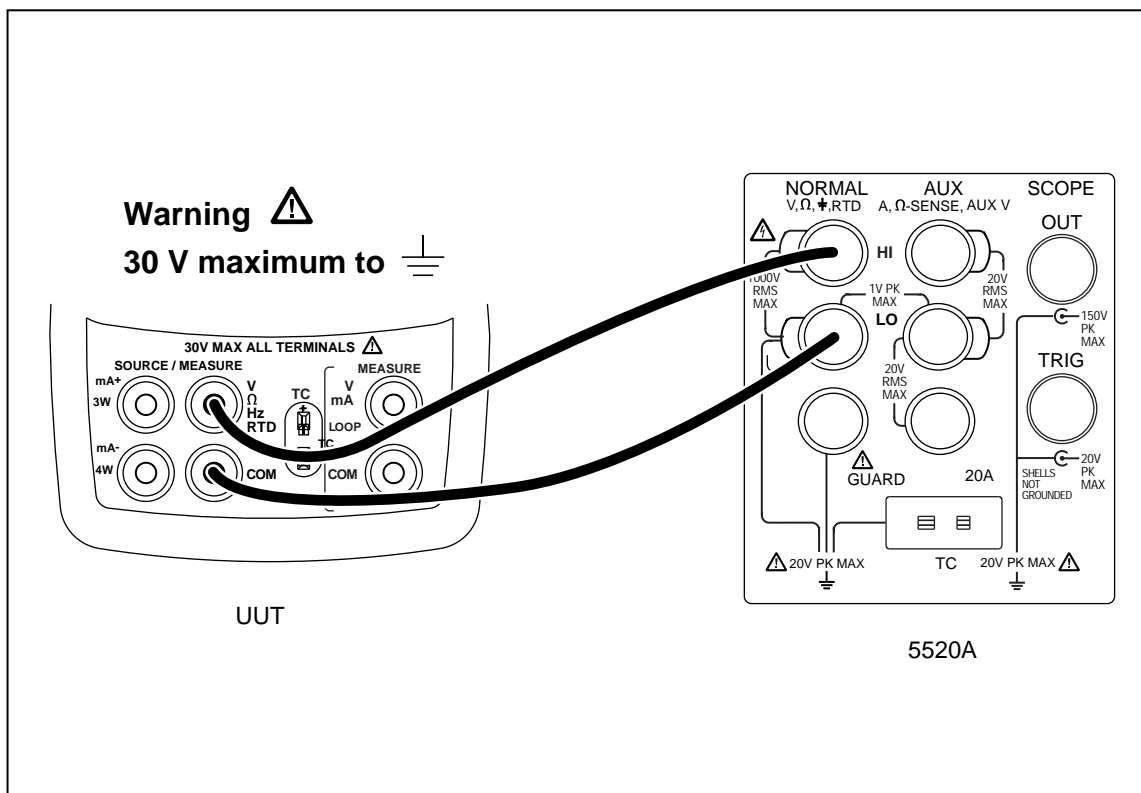

Figure 3. Lower Display mV and Voltage Test Connections

aal04f.eps

Table 7. Lower Display mV Readings

5520A Outputs	UUT Readings
0.00 mV	-0.02 mV to +0.02 mV
50.00 mV	49.97 mV to 50.03 mV
89.00 mV	88.96 mV to 89.04 mV

**Lower Display Voltage Measurement Tests**

1. Press **RESET** on the 5520A.
2. Press **V mA** on the UUT until **MEASURE** and **V** appear on the lower display.
3. Make the connections shown in Figure 3.
4. Set up the 5520A to output each of the voltages in Table 8 and verify that the UUT readings are within the limits shown.
5. Press **STBY** on the 5520A.

**Table 8. Lower Display Voltage Readings**

<b>5520A Outputs</b>	<b>UTT Readings</b>
0.000 V	-0.002 V to +0.002 V
10.000 V	9.996 V to 10.004 V
20.000 V	19.994 V to 20.006 V

### Upper Display mA Measurement Tests

1. Press **RESET** on the 5520A.
2. Press  $\frac{V}{mA}$  on the UUT until **MEASURE** and **mA** appear on the upper display.
3. Make the connections shown in Figure 4.
4. Set up the 5520A to output each of the voltages in Table 9 and verify that the UUT readings are within the limits shown.
5. Press **STBY** on the 5520A.

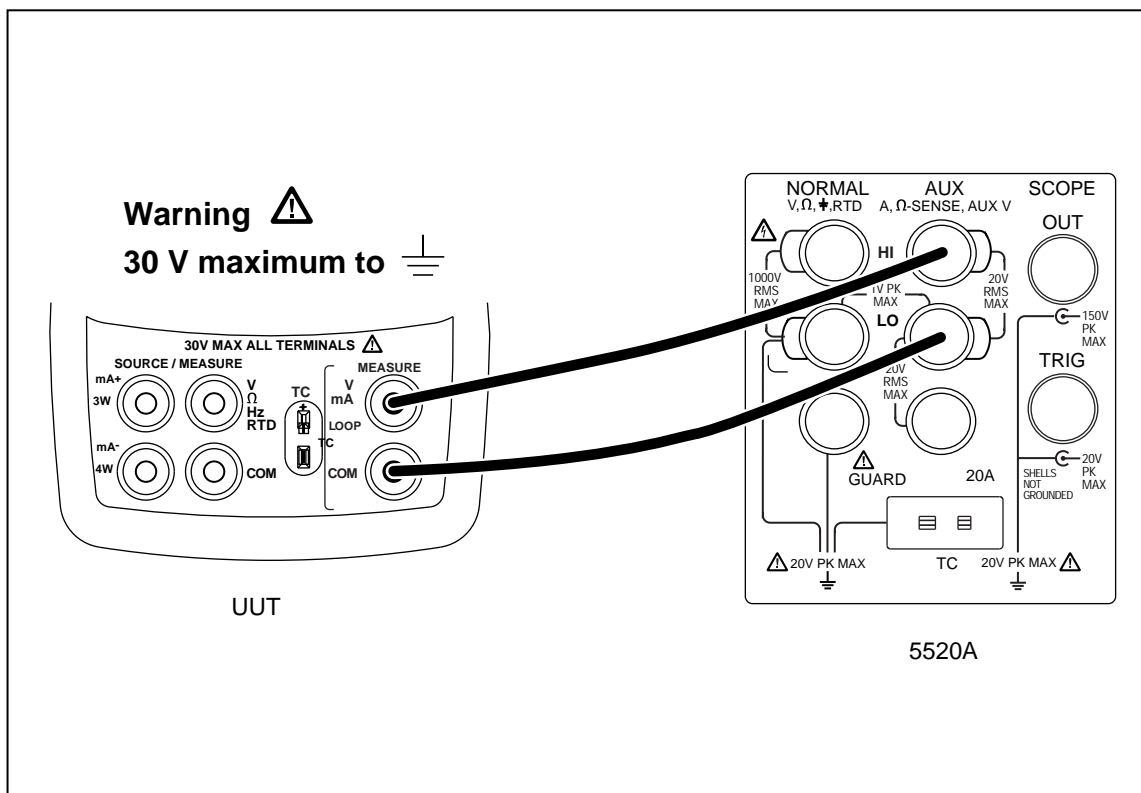

Figure 4. Upper Display mA Test Connections

aal05f.eps

Table 9. Upper Display mA Readings

5520A Settings	UUT Readings
0.000 mA	-0.002 mA to +0.002 mA
12.000 mA	11.995 mA to 12.005 mA
24.000 mA	23.993 mA to 24.007 mA

### Lower Display mA Measurement Tests (725 only)

1. Press **RESET** on the 5520A.
2. Press  $\frac{V}{mA}$  on the UUT until **MEASURE** and **mA** appear on the lower display.
3. Make the connections shown in Figure 5.
4. Set up the 5520A to output each of the voltages shown in Table 10 and verify that the UUT readings are within the limits shown.
5. Press **STBY** on the 5520A.

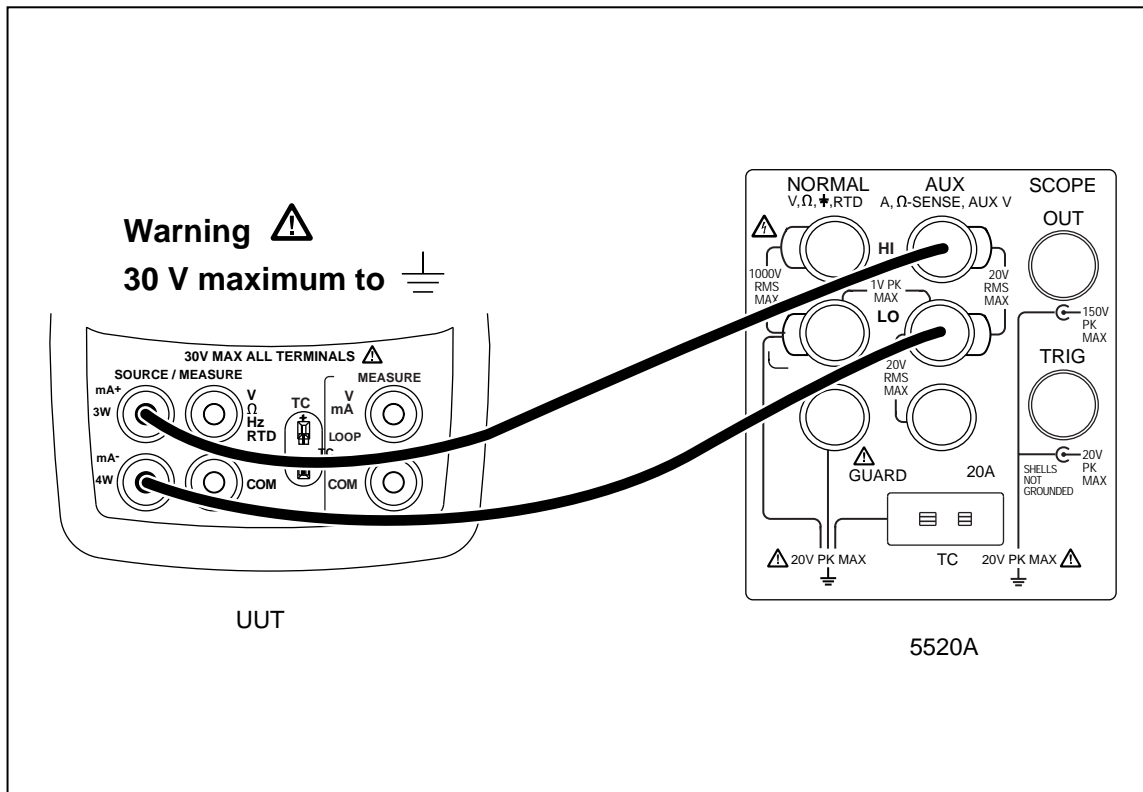

Figure 5. Lower Display mA Test Connections

aal06f.eps

Table 10. Lower Display mA Readings

5520A Outputs	UUT Readings
0.000 mA	-0.002 mA to +0.002 mA
12.000 mA	11.995 mA to 12.005 mA
24.000 mA	23.993 mA to 24.007 mA

### Lower Display Frequency Measurement Test (725 only)

1. Set the 5520A to source a 40 Hz, 1 V peak-to-peak square wave (use the blue softkey under the wave type to change the wave shape).
2. Press **Hz Ω** on the UUT until **MEASURE** and **Hz** appear on the lower display.
3. Make the connections shown in Figure 6.
4. Verify that the UUT frequency reads between 39.8 Hz and 40.2 Hz.
5. Press **Hz Ω** on the UUT to change the lower display to **kHz**.
6. Set the 5520A to source a 10 kHz, 1 V peak-to-peak square wave.
7. Verify that the UUT frequency reads between 9.98 kHz and 10.02 kHz.
8. Press **STBY** on the 5520A.

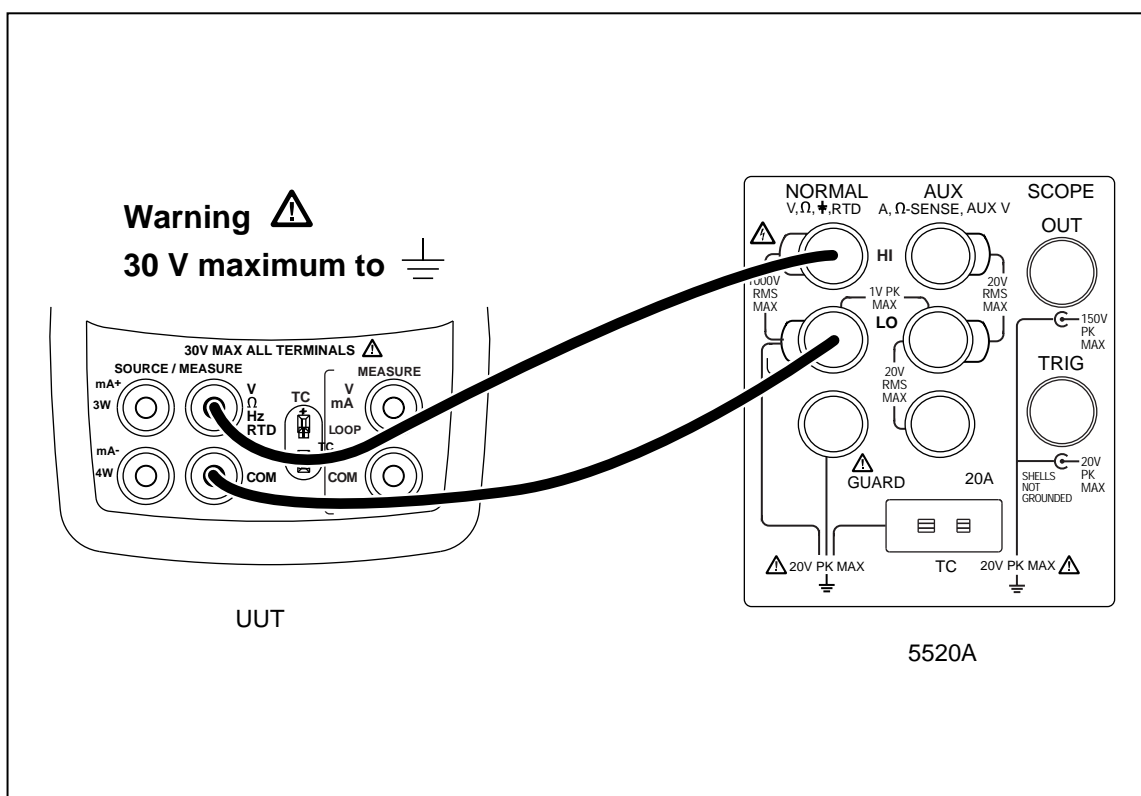





Figure 6. Lower Display Frequency Test Connections

aal04f.eps

**Lower Display Frequency Source Test (725 only)**

1. Press  on the UUT until **SOURCE** appears on the lower display.
2. Press  on the UUT until **Hz** appears on the lower display.
3. Configure the HP 3458A to measure frequency; then make the connections shown in Figure 7.
4. Use the arrow keys on the UUT to set the UUT output to the frequencies in Table 11 and verify that the HP 3458A readings are within the limits shown. (Use  to change the UUT output to kilohertz when necessary.)
5. Press  on the UUT to disable the sourcing function.

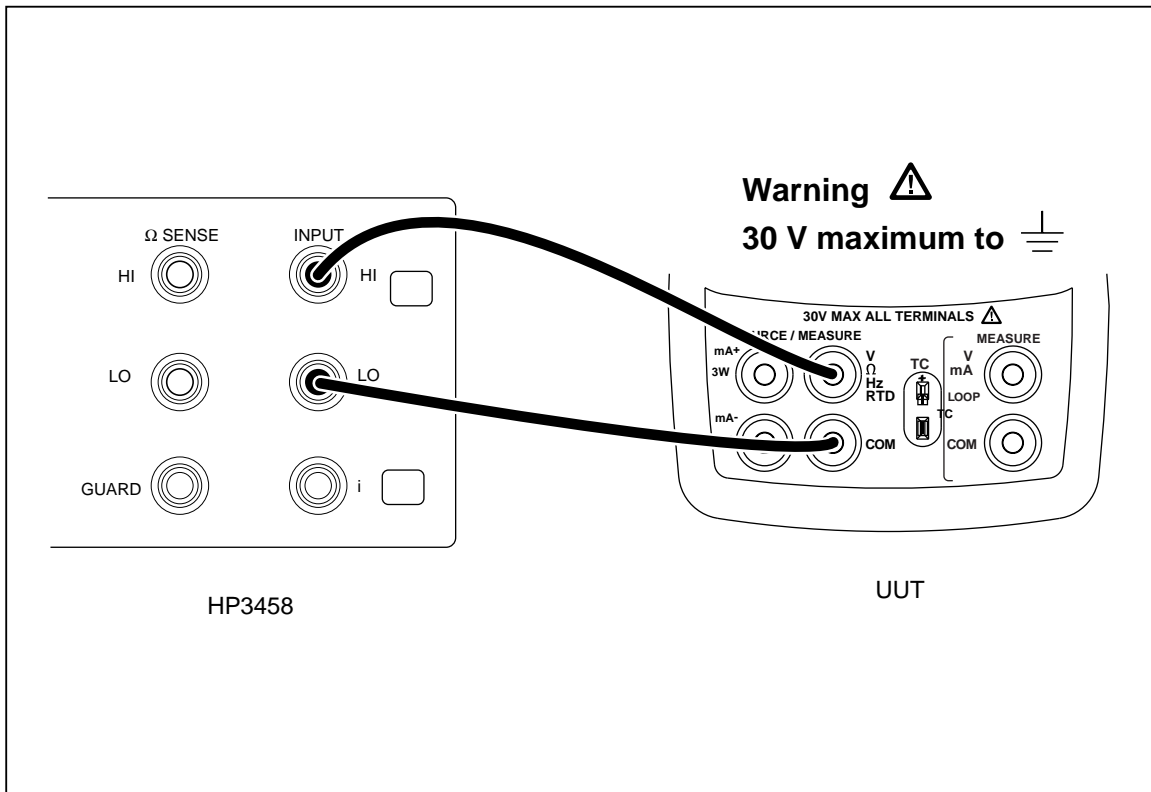

Figure 7. Lower Display Frequency Source Test Connections

aal08f.eps

Table 11. Lower Display Frequency Source Readings

UUT Outputs	HP 3458A Readings
40 Hz	39.98 Hz to 40.02 Hz
1000 Hz	999.5 Hz to 1000.5 Hz
1.0 kHz	997.5 Hz to 1002.5 Hz
4.0 kHz	3.990 Hz to 4.010 kHz
10.0 kHz	9.975 Hz to 10.025 kHz

### Lower Display 4-Wire Resistance Measurement Tests

1. Press **Hz Ω** on the UUT until  $\Omega$  appears on the lower display. If necessary, use **MEAS SOURCE** to get to the measure mode, and use **↺** to get to the **4W** mode. (**MEASURE** should also appear on the lower display).
2. Set the 5520A to 2-wire output with 2-wire compensation off; then make the connections shown in Figure 8.
3. Set the 5520A to source the resistance values in Table 12 and verify that the UUT resistance readings are within the limits shown.
4. Press **STBY** on the 5520A.

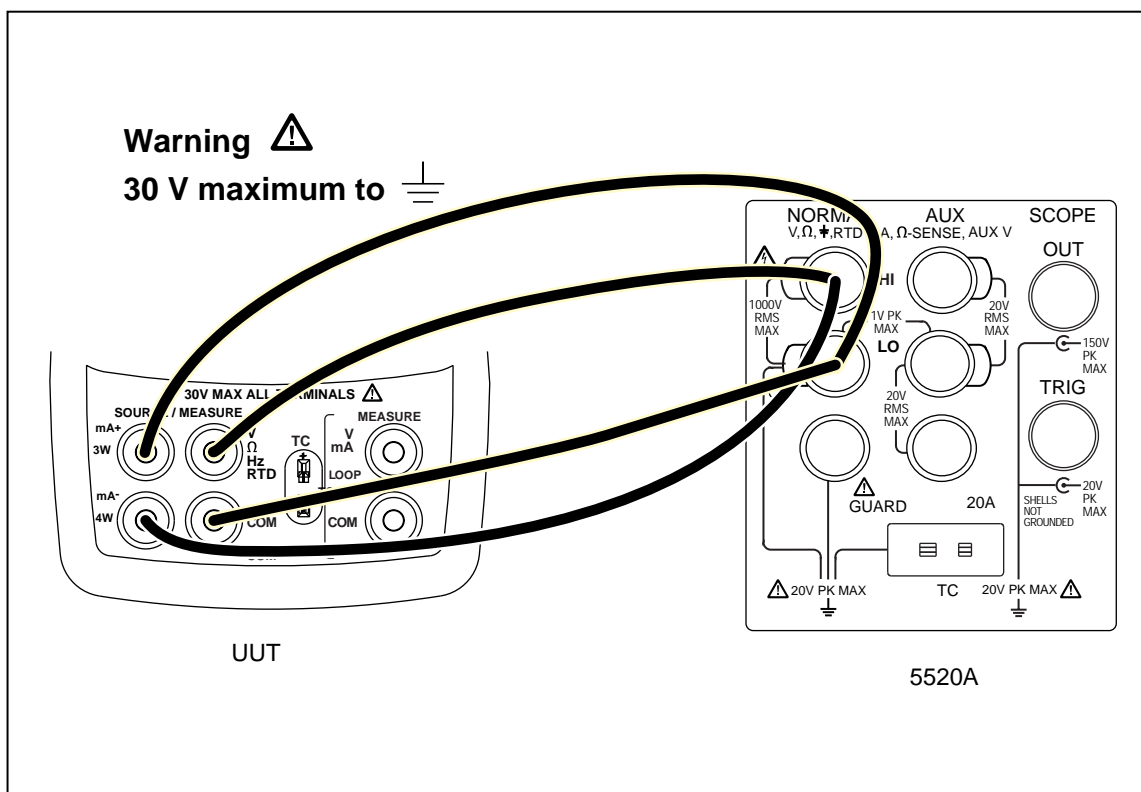

Figure 8. Lower Display 4-Wire Resistance Test Connections

Table 12. Lower Display 4-Wire Resistance Readings

5520A Outputs	UUT Readings
15.00 $\Omega$	14.90 $\Omega$ to 15.10 $\Omega$
300.00 $\Omega$	299.90 $\Omega$ to 300.10 $\Omega$
1500.0 $\Omega$	1499.5 $\Omega$ to 1500.5 $\Omega$
3000.0 $\Omega$	2999.0 $\Omega$ to 3001.0 $\Omega$

**Lower Display 4-Wire RTD Measurement**

1. Press **RTD** on the UUT until the lower display reads **PT3916**. If necessary, use **°C °F** to select °C units and **↶** to get to the **4W** mode. (**MEASURE** should also appear on the lower display.)
2. Set the 5520A to 2-wire output with 2-wire compensation off; then make the connections shown in Figure 8.
3. Set the 5520A to source the resistance values in Table 13 and verify that the UUT temperature readings are within the limits shown for the 4-wire readings.

**Table 13. Lower Display 4-Wire and 3-Wire RTD Temperature Readings**

5520A Outputs (°C)	3-Wire UUT Readings (°C)	4-Wire UUT Readings (°C)
-180.0 (25.799 Ω)	-179.5 to -180.5	-179.7 to -180.3
100.0 (139.171 Ω)	99.5 to 100.5	99.7 to 100.3
550.0 (300.822 Ω)	549.5 to 550.5	549.7 to 550.3



### Lower Display 3-Wire RTD Measurement

1. Press **RTD** on the UUT until the lower display reads **PT3916**. If necessary, use **°C °F** to select °C units and the arrow keys to get to the **3W** mode. (**MEASURE** should also appear on the lower display.)
2. Set the 5520A to 2-wire output with 2-wire compensation off; then make the connections shown in Figure 9.
3. Set the 5520A to source the resistance values in Table 13 and verify that the UUT temperature readings are within the limits shown for the 3-wire readings.
4. Press **STBY** on the 5520A.

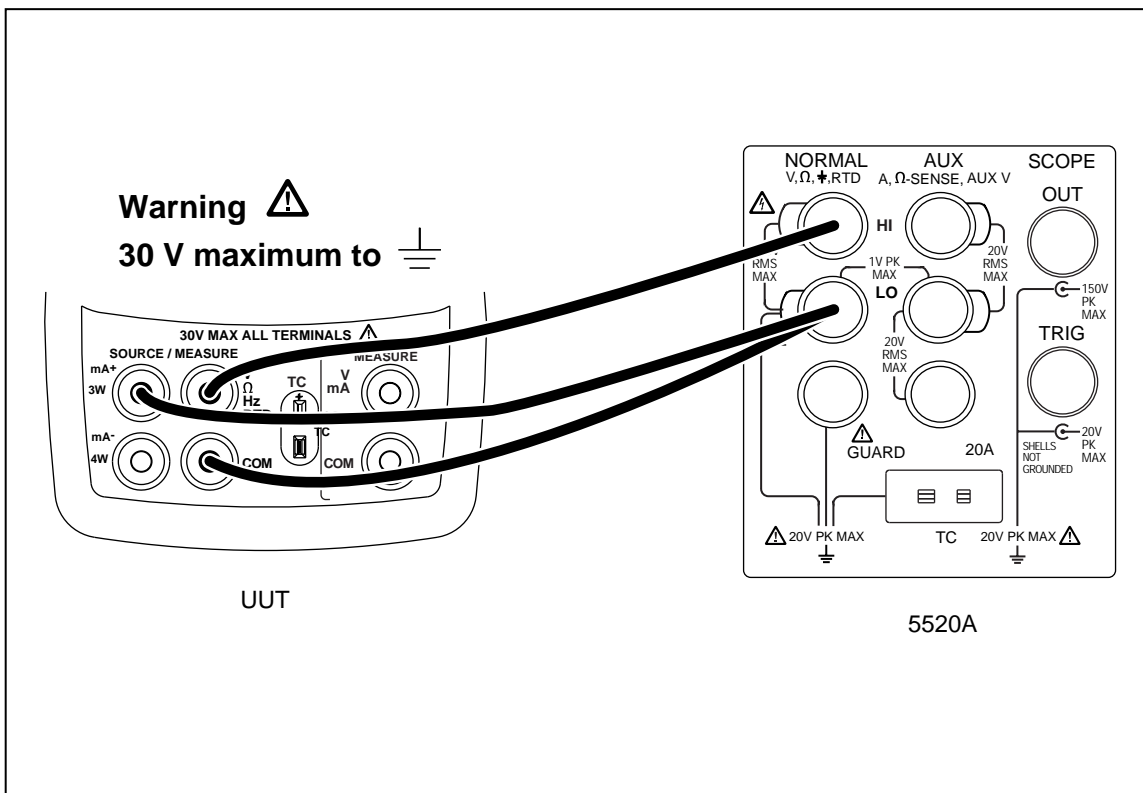

Figure 9. Lower Display 3-Wire Resistance Test Connections

aal10f.eps

### Lower Display Thermocouple Measurement Tests

1. Remove the test leads from the UUT terminals; then connect a type J thermocouple lead between the TC jack on the UUT and the TC jack on the 5520A, as shown in Figure 10.
2. Press **TC** on the UUT until **J** appears on the lower display. If necessary, press **°C °F** so the temperature is displayed in °C.
3. Set the 5520A to output the type J thermocouple voltages shown in Table 14 and verify the UUT temperature readings are within the limits shown (values use the ITS-90 curves).
4. Press **STBY** on the 5520A.

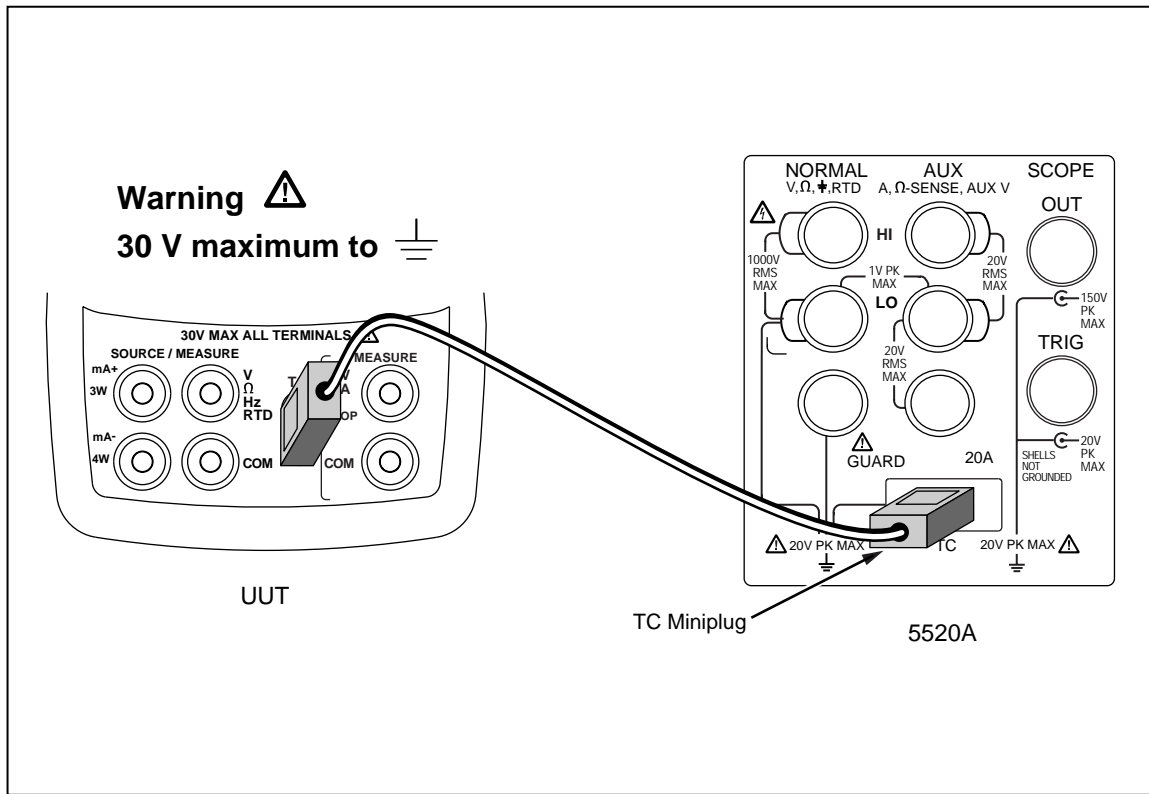





Figure 10. Lower Display Thermocouple Test Connections

aal11f.eps

Table 14. Type J Thermocouple Readings

5520A Settings (referenced to 0 °C)	UUT Readings
-180.0 °C (-7.403 mV)	-179.0 °C to -181.0 °C
0.0 °C (0.000 mV)	-0.7 °C to +0.7 °C
750.0 °C (42.281 mV)	749.3 °C to 750.7 °C



### **Lower Display Thermocouple Source Tests**

1. Set the 5520A to measure type J thermocouple voltages.
2. Press  on the UUT until **SOURCE** appears on the lower display. If necessary, press  on the UUT until **J** appears on the lower display and press  so the temperature is displayed in °C.
3. Use the arrow keys to set the UUT outputs to the temperatures in Table 15 and verify that the 5520A temperature readings are within the limits shown.
4. Press **STBY** on the 5520A. Remove the TC lead from the 5520A and the UUT.

**Table 15. Lower Display Thermocouple Source Readings**

UUT Settings	5520A Readings (referenced to 0 °C)
-180.0 °C	-179.0 °C to -181.0 °C
0.0 °C	-0.7 °C to +0.7 °C
750.0 °C	749.3 °C to 750.7 °C

### Lower Display mA Source Tests (725 only)

1. Press  on the UUT until **SOURCE** appears on the lower display; then press  until **mA** appears on the lower display. If necessary, press  until **SOURCE** appears on the lower display.
2. Set the HP 3458A to measure dc current.
3. Connect the UUT and the HP 3458A as shown in Figure 11.
4. Use the arrow keys on the UUT to set the UUT to the currents in Table 16 and verify that the HP 3458A readings are within the limits shown.

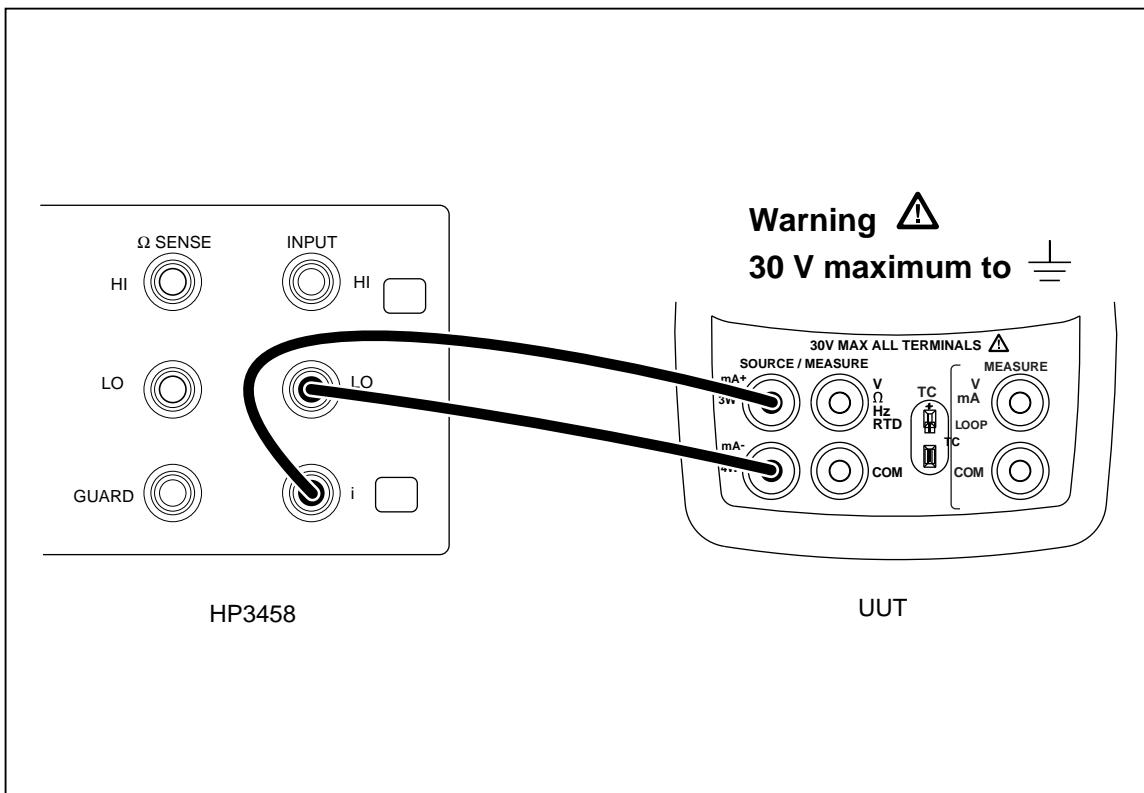





Figure 11. Lower Display mA Source Connections

aal12f.eps

Table 16. Lower Display mA Source Readings

UUT Outputs	HP 3458A Readings
4.000 mA	3.9972 mA to 4.0028 mA
12.000 mA	11.9956 mA to 12.0044 mA
20.000 mA	19.9940 mA to 20.0060 mA
24.000 mA	23.9932 mA to 24.0068 mA



### Lower Display mV Source Tests

1. Press  on the UUT until **SOURCE** appears on the lower display; then press  until **mV** appears on the lower display.
2. Set the HP 3458A to measure dc voltage in the 200 mV range.
3. Connect the UUT to the HP 3458A as shown in Figure 7.
4. Use the arrow keys on the UUT to set the UUT output to the current values in Table 17 and verify that the HP 3458A readings are within the limits shown.
5. Press  on the UUT to disable the sourcing function.

**Table 17. Lower Display mV Source Readings**

UUT Outputs	HP 3458A Readings
0.00 mV	-0.020 mV to +0.020 mV
50.00 mV	49.970 mV to 50.030 mV
100.00 mV	99.960 mV to 100.040 mV

### Lower Display Voltage Source Tests

1. Press  on the UUT until **SOURCE** appears on the lower display; then press  until **V** appears on the lower display.
2. Set the HP 3458A to measure dc voltage in the 20 V range.
3. Connect the UUT to the HP 3458A as shown in Figure 7.
4. Use the arrow keys on the UUT to set the UUT outputs to the currents in Table 18 and verify that the HP 3458A readings are within the limits shown. You can use a lower voltage range on the HP 3458A to verify the 0 V range.

**Table 18. Lower Display Voltage Source Readings**

UUT Outputs	HP 3458A Readings
0.000 V	-0.002 V to +0.002 V
5.000 V	4.9970 V to 5.0030 V
10.000 V	9.9960 V to 10.0040 V

### Lower Display Ohms Source Tests

1. Press  $\square$  Hz  $\Omega$  on the UUT until  $\Omega$  appears on the lower display. If necessary, press  $\square$  MEAS SOURCE until **SOURCE** appears on the lower display.
2. Set the HP 3458A to measure 4-wire resistance.
3. Make the connections shown in Figure 12.
4. Use the arrow keys on the UUT to set the UUT output to the resistance values in Table 19 and verify that the HP 3458A readings are within the limits shown.

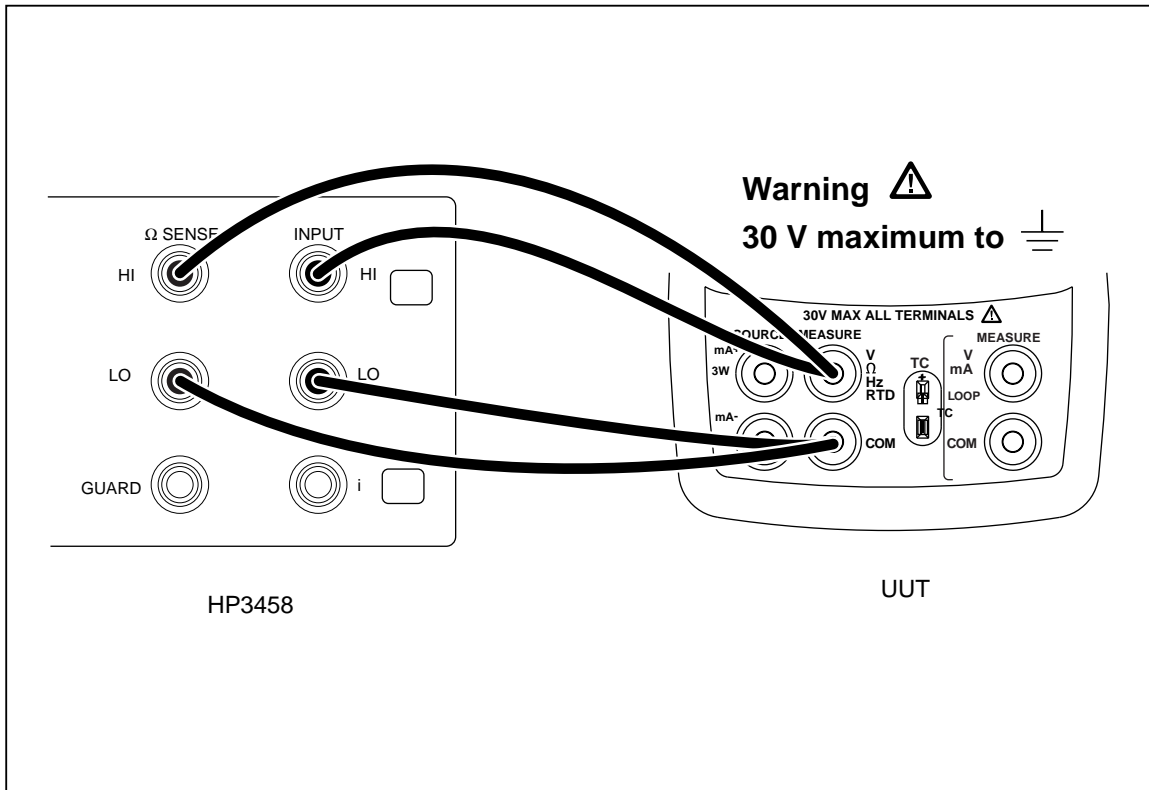



Figure 12. Lower Display Ohms Source Test Connections

Table 19. Lower Display Ohms Source Readings

UUT Settings	HP 3458A Readings
15.0 $\Omega$	14.9 $\Omega$ to 15.1 $\Omega$
360.0 $\Omega$	359.9 $\Omega$ to 360.1 $\Omega$
1500 $\Omega$	1499.5 $\Omega$ to 1500.5 $\Omega$
3200 $\Omega$	3199.0 $\Omega$ to 3201.0 $\Omega$

The performance tests for the 724 are now complete. Disconnect and secure all test equipment.

***Pressure Module Input***

1. Connect a Fluke 700 Series Pressure Module to the 5-pin LEMO connector at the top of the UUT; then press .
2. Verify that the display first shows **----psi**, then changes to a pressure value.
3. Disconnect the pressure module from the UUT.

The performance tests for the 725 are now complete. Disconnect and secure all test equipment.

## Calibration Adjustment Procedures

The Fluke 724 and 725 Calibrators have an electronic calibration. There are no mechanical adjustments and the calibration is done case closed. The calibration is done via a serial communications port, by sending and receiving, commands and readings. For the 725 serial port connection, you will need the 700SC Serial Interface Cable, PN 667425. This will permit you to communicate through the pressure port connection. When calibrating the 724 you will need the 724/725 Calibration Cable, PN 1556747, this connects to the 10-pin header in the battery compartment. This cable will also work with the 725.

Throughout these procedures, the Fluke 724 and Fluke 725 are referred to as UUT. Two methods of calibration are available for the UUT: using a serial-based program via a PC (see Table 2 for requirements), and using a Met/Cal calibration procedure. This manual only describes the serial-based PC program. The automated Met/Cal procedures are available from the Fluke Metrology Group. For more information on the automated Met/Cal procedures contact Fluke or visit the Fluke Web site at [www.fluke.com](http://www.fluke.com).

### Setup

Setup the PC and UUT as follows:

1. Ensure that the terminal communications software is installed on the PC.
2. Connect the interface cable to the appropriate connector on the UUT.
3. Connect the 9-pin 'D' connector to the PC serial port. An adapter may be needed for PCs that use 25-pin 'D' serial connectors.
4. Verify the settings on the PC are as follows:
  - Bits per second: 9600
  - Data bits: 8
  - Parity: None
  - Stop bits: 1
  - Flow control: None
  - Local echo on



### Initiating Communication

Starting with the UUT off, push and hold **RECALL** while turning the UUT on. Continue to hold **RECALL** until "Cal mode" is displayed. The calibration menus, as seen on the PC screen, are as follows:

#### 725 Calibration Menu

```
Calibrate Menu
1 - Cal Volts Input
2 - Cal Volts Output
3 - Cal mA Input
4 - Cal mA Output
5 - Cal mV Input
6 - Cal mV Output
7 - Cal Thermocouples
8 - Cal Ohms Hi Source
9 - Cal Ohms Low Source
A - Cal RTD LOW Range
B - Cal RTD HI Range
C - Cal ISO Volts
D - Cal ISO mA
```

Enter Selection :

#### 724 Calibration Menu

```
Calibrate Menu
1 - Cal Volts Input
2 - Cal Volts Output
3 - Cal mV Input
4 - Cal mV Output
5 - Cal Thermocouples
6 - Cal Ohms Hi Source
7 - Cal Ohms Low Source
8 - Cal RTD LOW Range
9 - Cal RTD HI Range
A - Cal ISO Volts
B - Cal ISO mA

Enter Selection :
```

To begin calibration, type the cal step (letter or number), then press Enter. You do not need to run all of the calibration steps when you are in the calibration mode.

When calibrating thermocouples, you must first calibrate mV Input and mV Output. At the end of each step on the calibration menu, the new calibration constants for that step are saved, but not actually used until power is recycled.

When calibrating a measurement function, you must enter an input signal. When the signal is connected and stable, press the space bar to start the adjustment. Usually, the UUT will display a calibration constant, then prompt for a second input value. Apply the new input value, then press the space bar. After the adjustment is complete, press the space bar to return to the Calibration Menu.

When calibrating a source function, you must enter the value of a reading. Type in the numerical value of the calibration desired. This will put you into the desired calibration mode. When entering the calibration data for any source mode calibration, be sure that you enter the value in the units listed, but don't enter the units (mV, mA, etc.). After the adjustment is complete, press the space bar to return to Calibration Menu. The calibration values will vary slightly, unit to unit. The constants used in this procedure may not appear exactly the same as on your UUT, but they should be approximately the same.

### Cal Volts Input

Connect the UUT as shown in Figure 13.

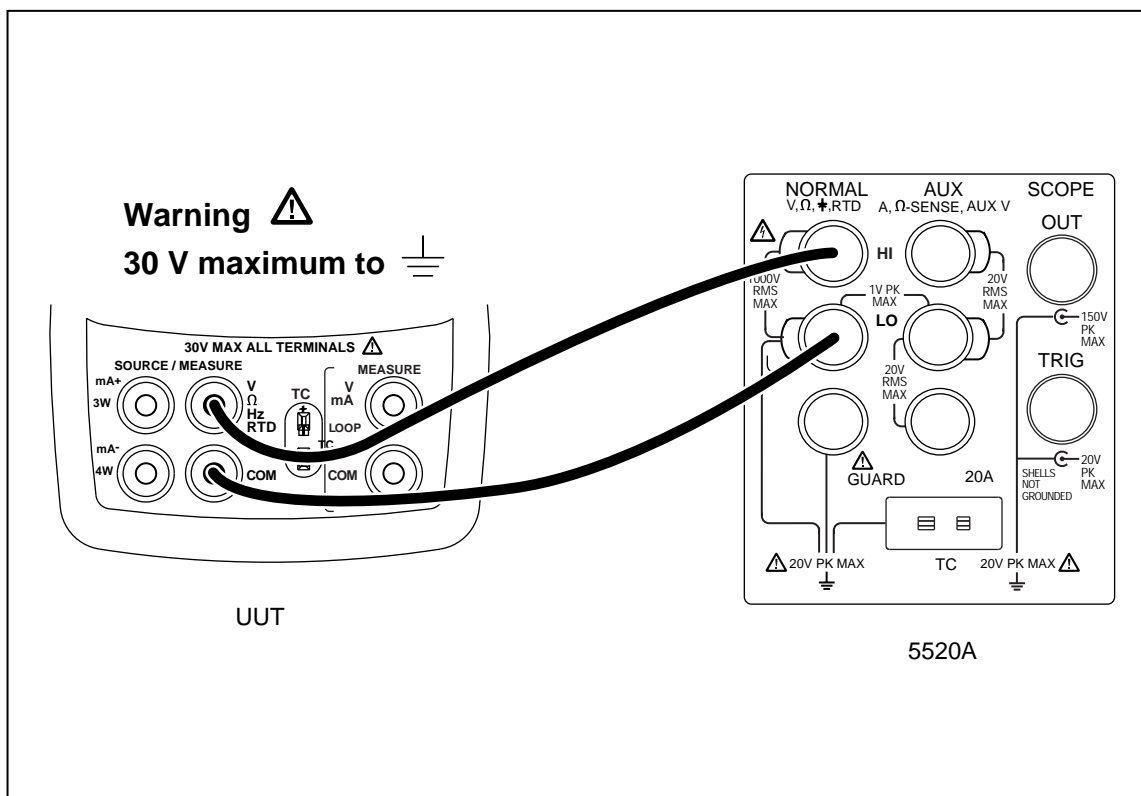

Figure 13. Volts Input Calibration Connections

From the Calibration Menu, type the cal step for Cal Volts Input. The PC displays:

```
Enter 0 Volts - press space bar to continue
```

Set the Fluke 5520A to output 0.0000 V, then press the space bar. After a short while, the following calibration constant and prompt are displayed on the PC:

```
Offset = -40
Enter 10.00 Volts - press space bar to continue
```

Set the Fluke 5520A to output 10.0000 V, and press the space bar. After a short while, the following calibration constants and prompt are displayed on the PC:

```
diff = (Counts - Offset)
3032676 = 3032636 - -40
Volts per count = 0.000003
- press space bar to continue
```

Press the space bar to return to the Calibration Menu.

### Cal Volts Output

Connect the UUT as shown in Figure 14.

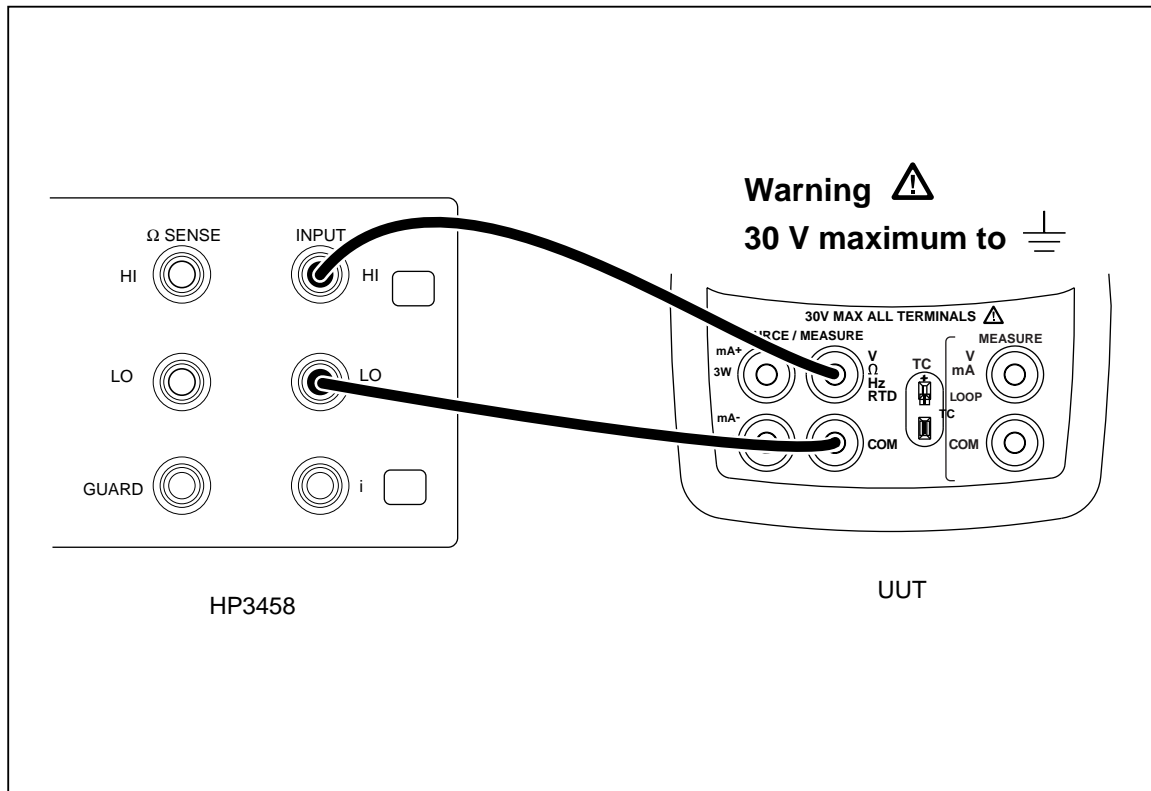

**Figure 14. Volts Output Calibration Connections**

aal08f.eps

From the Calibration Menu, type the number or letter for Cal Volts Output. The PC displays:

```
Zero into DAC. Enter the Volts displayed :
```

Set the HP 3458 to read V DC. Be sure the NPLC on the HP 3458 is slow enough to get stable readings to four decimal places. When the reading on the HP 3458 has stabilized, enter the value in volts on the PC, and press Enter. You only need to enter four places past the decimal point and do not need to enter the units (V). After a short while, the PC displays:

```
Max value into DAC. Enter the Volts displayed :
```

Enter the voltage reading (four places past the decimal) from the HP 3458 on the PC, then press Enter. After a short while the PC displays the following calibration constants and new prompt:

```
0.000170 = 11.071999 - 0.000000 )/ 65279.00
- press space bar to continue
```

Press the space bar to return to the Calibration Menu.

### Cal mA Input (Fluke 725 Only)

Connect the UUT as shown in Figure 15.

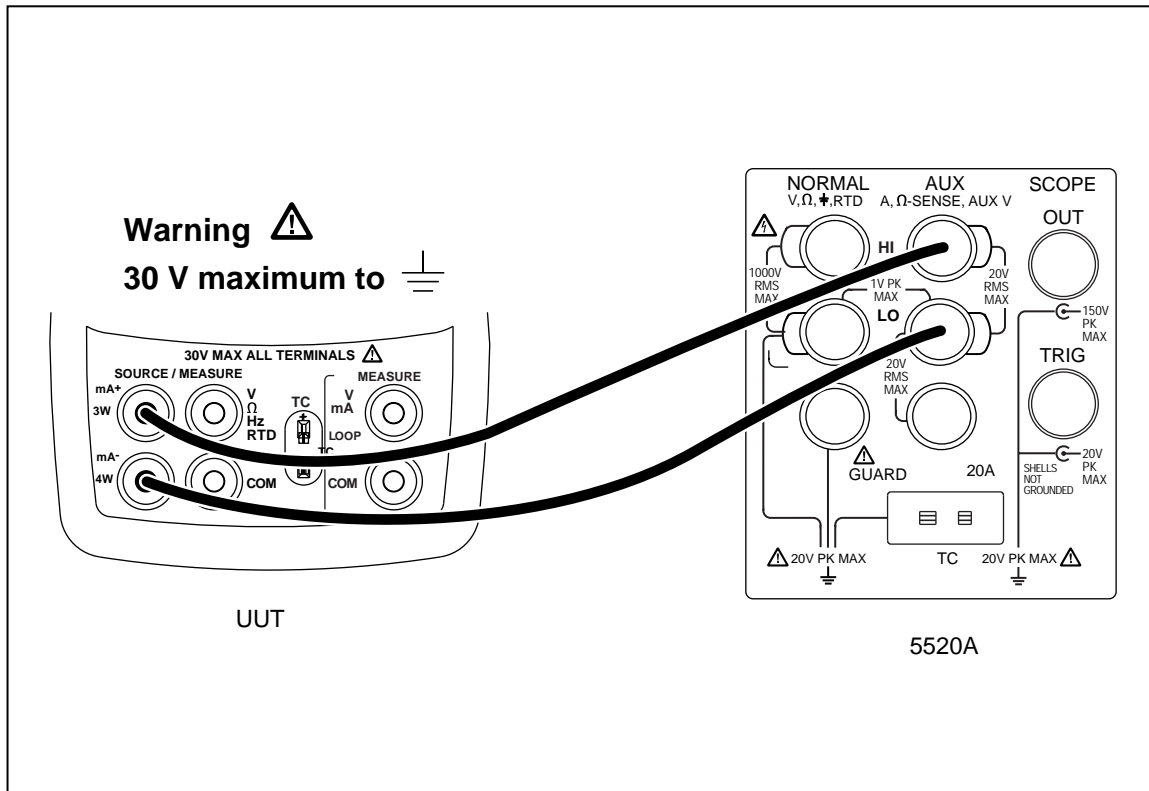

Figure 15. mA Input Calibration Connections

aal06f.eps

From the Calibration Menu, type the cal step for Cal mA Input. The PC displays:

```
Enter 0 ma - press space bar to continue
```

Set the Fluke 5520A to output 0.000 mA, let the reading settle a few seconds, then press the space bar on the PC. After a short while, the PC displays the following calibration constant and new prompt:

```
Offset = -337
Enter 24.00 ma - press space bar to continue
```

Set the Fluke 5520A to output 24.000 mA, let the reading settle a few seconds, then press the space bar on the PC. After a short while, the UUT displays the following calibration constants and new prompt:

```
diff = (Counts - Offset)
8106924 = 8106587 - -337
mA per count = 0.000003
press space bar to continue
```

Press the space bar to return to the Calibration Menu.

**Cal mA Output (Fluke 725 Only)**

Connect the UUT as shown in Figure 16.

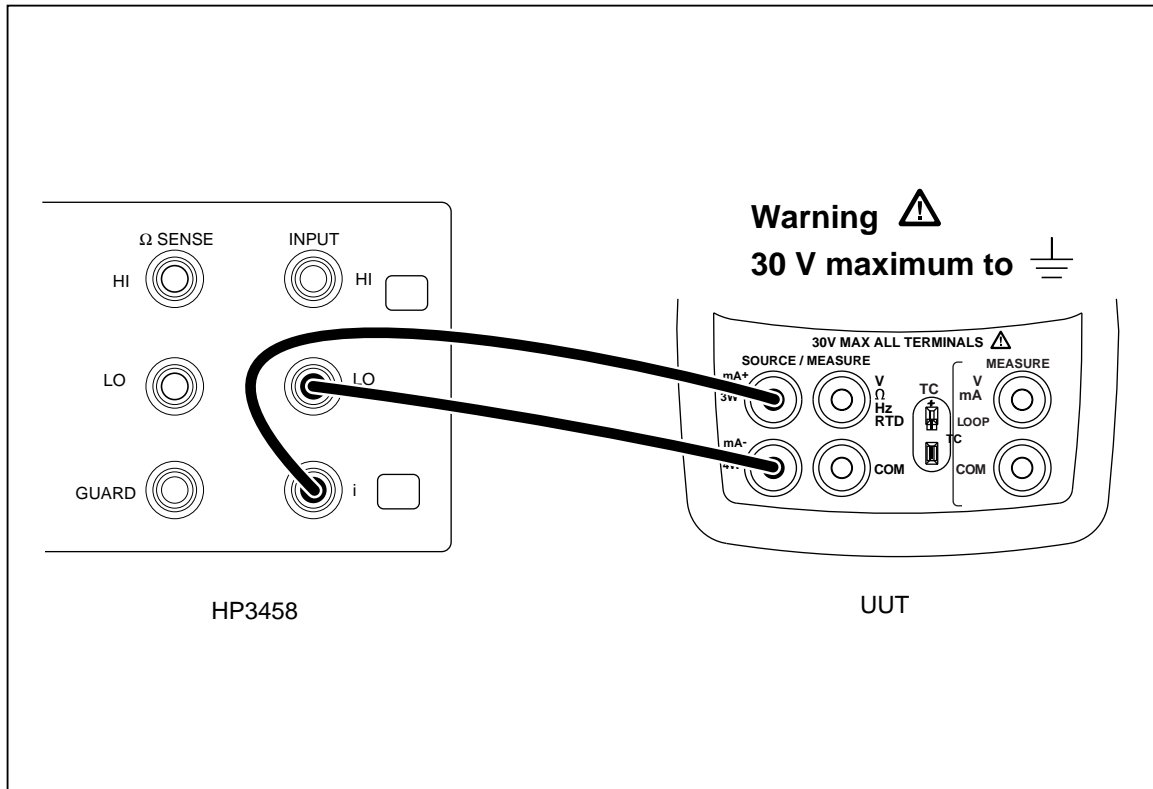

**Figure 16. mA Output Calibration Connections**

aal12f.eps

From the Calibration Menu, enter the cal step for Cal mA Output. The PC displays:

```
Zero into DAC. Enter mA displayed :
```

Set the HP 3458 to read DC current. Be sure the NPLC on the HP 3458 is slow enough to get stable readings to four decimal places. When the reading on the HP 3458 has stabilized, enter the value in milliamps on the PC, then press Enter. You only need to enter four places past the decimal point and do not need to enter the units (mA). Wait for the following prompt on the PC:

```
Max value into DAC. Enter mA value displayed :
```

Enter the current reading from the HP 3458 in the PC, then press Enter. After a short while, the following calibration constants and new prompt are displayed on the PC:

```
-1.628906 = ( 24.735999 - 0.076400 ) / 65279.00
mA per count = -1.628906
- press space bar to continue
```

Press the space bar to return to the Calibration Menu.

### Cal mV Input

Connect the UUT as shown in Figure 17.

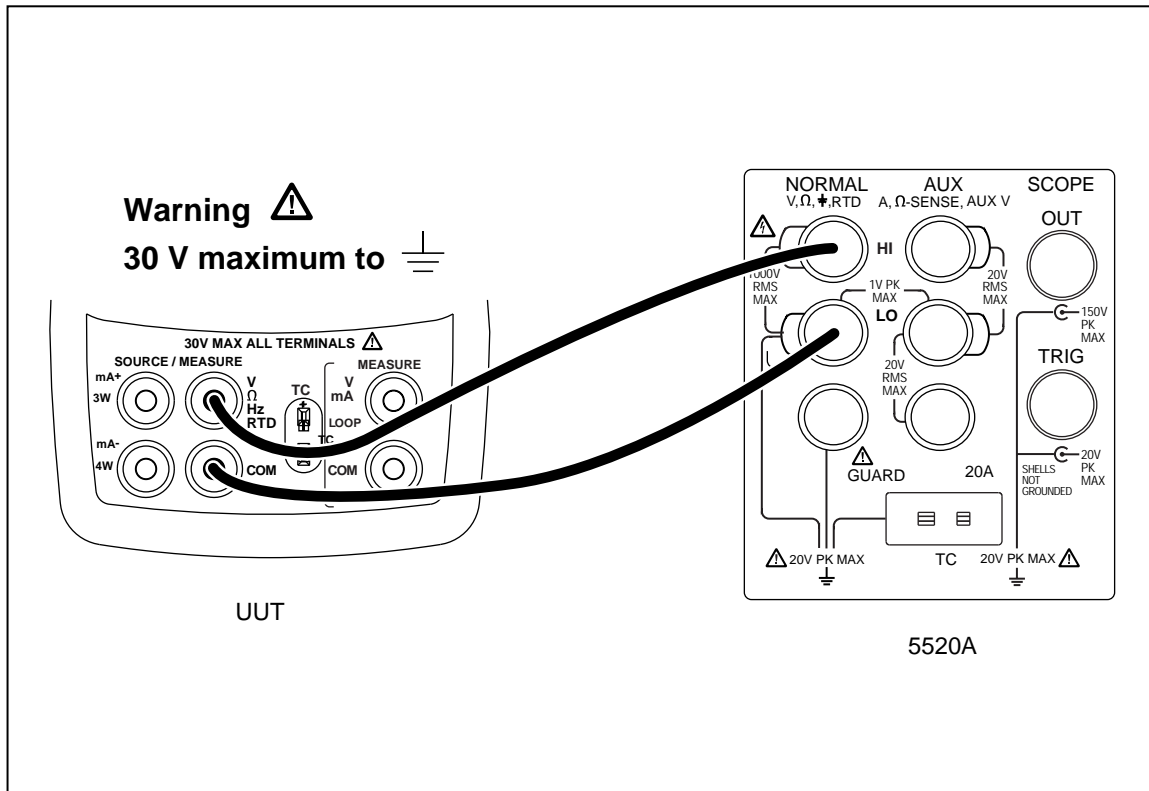

Figure 17. mV Input Calibration Connections

aal04f.eps

From the Calibration Menu, type the number or letter for Cal mV Input. The PC displays:

```
Enter 0 mV - press space bar to continue
```

Set the Fluke 5520A to output 0.000 mV, let the output settle then press the space bar on the PC. After a short while, the PC displays the following calibration constant and new prompt:

```
Offset = -714
Enter 90.00 mV - press space bar to continue
```

Set the Fluke 5520A to output 90.000 mV, let the output settle, then press the space bar on the PC. After a short while, the PC displays the following calibration constants and new prompt:

```
diff = (Counts - Offset)
7513104 = 7512390 - -714
mV per count = 0.000012
-press space bar to continue
```

Press the space bar to return to the Calibration Menu.

### Cal mV Output

Connect the UUT as shown in Figure 18.

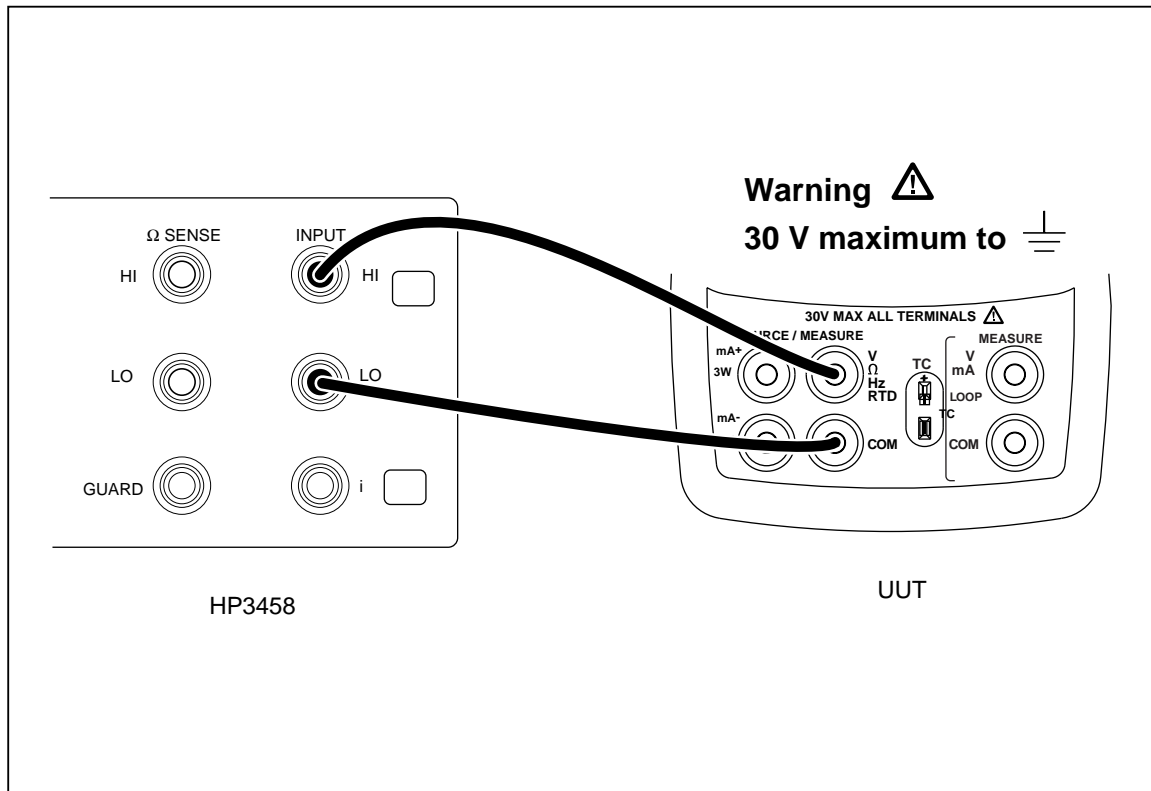

**Figure 18. mV Output Calibration Connections**

aal08f.eps

From the Calibration Menu, enter the cal step for Cal mV Output. The PC displays:

Zero into DAC. Enter mV displayed :

Set the HP 3458 to read V DC. Be sure the NPLC on the HP 3458 is slow enough to get stable readings to three decimal places. When the reading on the HP 3458 has stabilized, enter the value in millivolts on the PC, then press Enter. You only need to enter four places past the decimal point and do not need to enter the units (mV). After a short while, the PC displays:

Max value into DAC. Enter mV value displayed :

Enter the mV reading from the HP 3458 on the PC, press Enter, then press the space bar. After a short while, the PC displays the following calibration constants and new prompt:

```
6537.086487 = 111.874998 - -12.450000 )/ 65279.00 mV per count = 6537.0864
87
- press space bar to continue
```

Press the space bar to return to the Calibration Menu.

## Cal Thermocouples

Connect the UUT as shown in Figure 19.

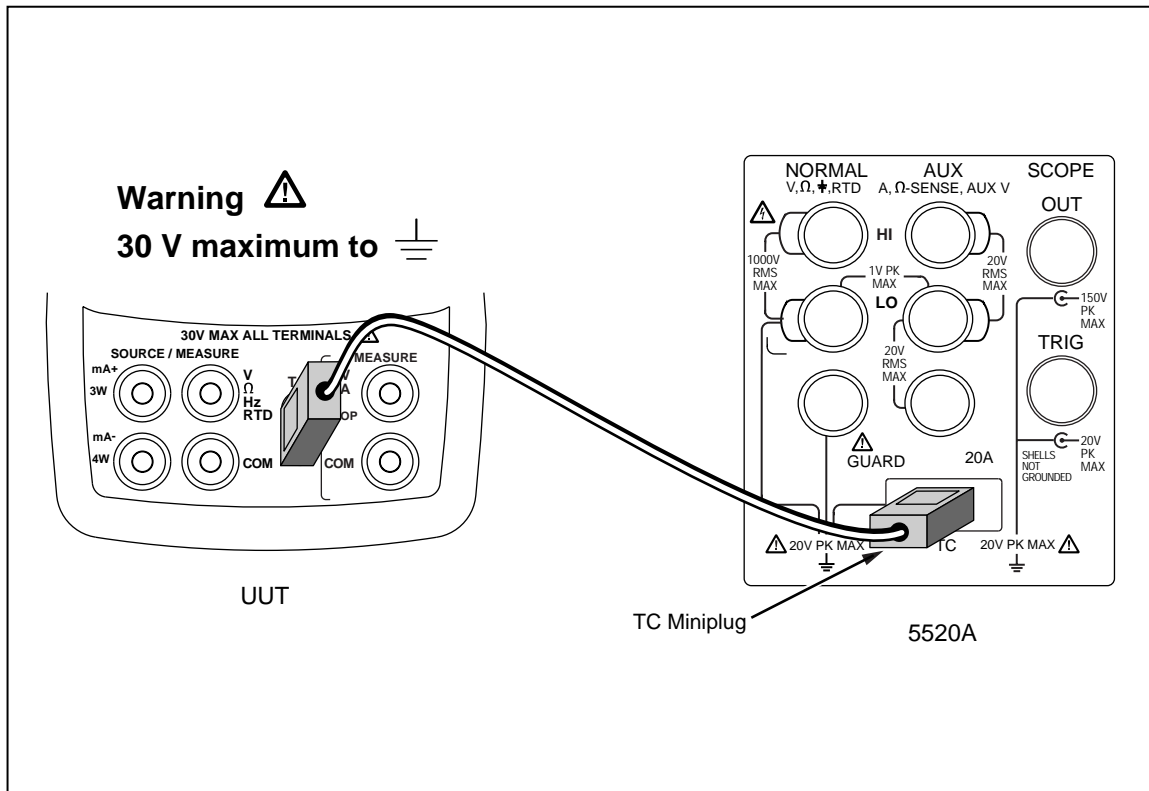

Figure 19. Thermocouples Calibration Connections

aal11f.eps

From the Calibration Menu, enter the cal step for Cal Thermocouples. The PC displays:

```
Connect accurate T/C source : TYPE J thermocouple
Simulate 0.0 degrees C
- press space bar to continue
```

Set the Fluke 5520A to output 0.00 degrees C for a type-J thermocouple using the ITS-90 standard, then press the space bar on the PC. After a short while, the PC displays the following calibration constant and new prompt:

```
CJC Temp Read = 27.359071
Type 2
CJC mV = 1.400393

mV Read = -1.260579

CJC = 0.139814, (cjc - type_j) = 2.736758
- press space bar to continue
```

Press the space bar to return to the Calibration Menu.



### Cal Ohms Hi Source

Connect the UUT as shown in Figure 20.

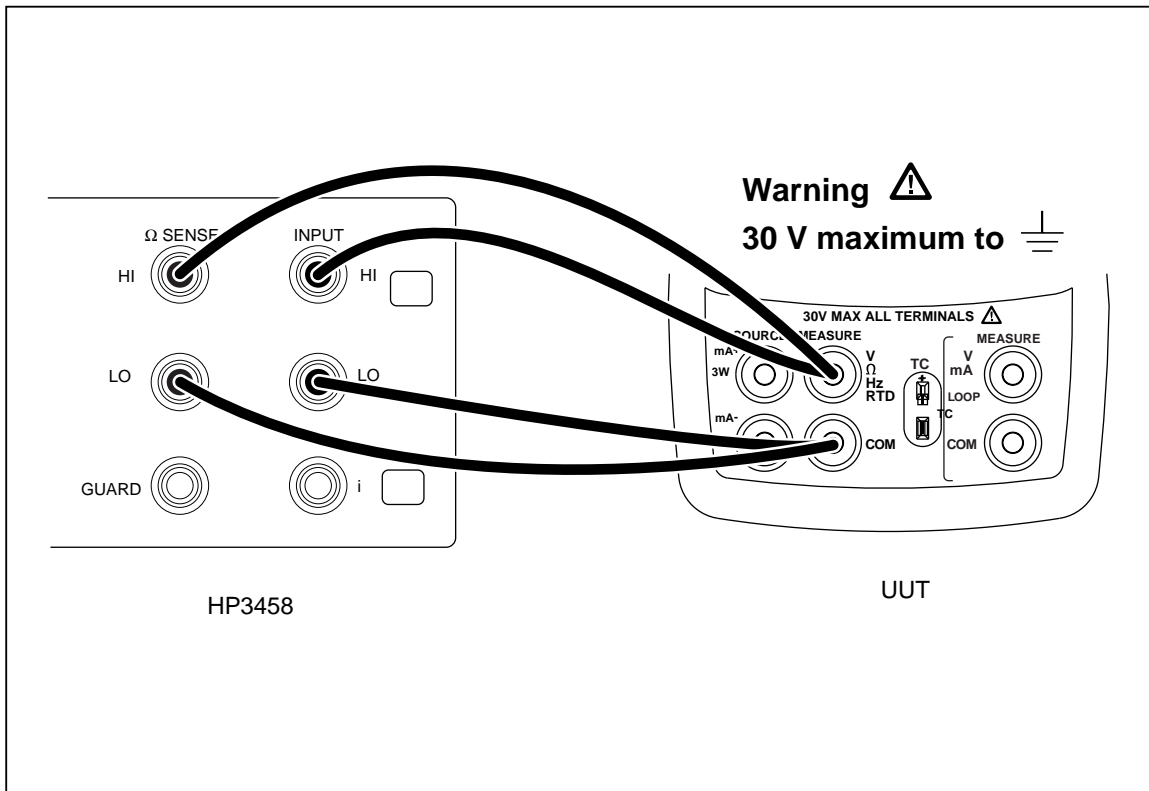

**Figure 20. Ohms Hi Source Calibration Connections**

aal13f.eps

From the Calibration Menu, enter the cal step for Cal Ohms Hi Source. The PC displays:

```
2500 into DAC. Enter Ohms displayed :
```

Set the HP 3458 to read 4-terminal Ohms. Be sure the NPLC on the HP 3458 is slow enough to get stable readings. When the reading on the HP 3458 has stabilized, enter the value in Ohms on the PC, then press Enter. After a short while, the PC displays:

```
Max value into DAC. Enter Ohms value displayed :
```

Enter the resistance reading from the HP 3458 in the PC, then press Enter. After a short while, the PC displays the following calibration constants and new prompt:

```
0.050685 = 3309.000015 - 0.365000 )/ 65279.00 Ohms per count = 0.050685
- press space bar to continue
```

Press the space bar to return to the Calibration Menu.

**Cal Ohms Low Source**

The UUT connection is the same as cal Ohms Hi Source, it is shown in Figure 20.

From the Calibration Menu, enter the cal step for Cal Ohms Low Source. The PC displays:

```
2500 into DAC. Enter Ohms displayed :
```

Set the HP 3458 to read 4 terminal Ohms. Be sure the NPLC on the HP 3458 is slow enough to get stable readings. When the reading on the HP 3458 has stabilized, enter the value in Ohms on the PC, then press Enter. After a short while, the PC displays:

```
Max value into DAC. Enter Ohms value displayed :
```

Enter the resistance reading from the HP 3458 in the PC, then press Enter. After a short while, the PC displays the following calibration constants and new prompt:

```
Gain = 0.006910  
y intercept = -57  
= 451.459980 - 17.670000 )/ 65279.00 - press space bar to continue
```

Pressing the space bar will return to the Calibration menu.

### Cal RTD Low Range

Connect the UUT as shown in Figure 21.

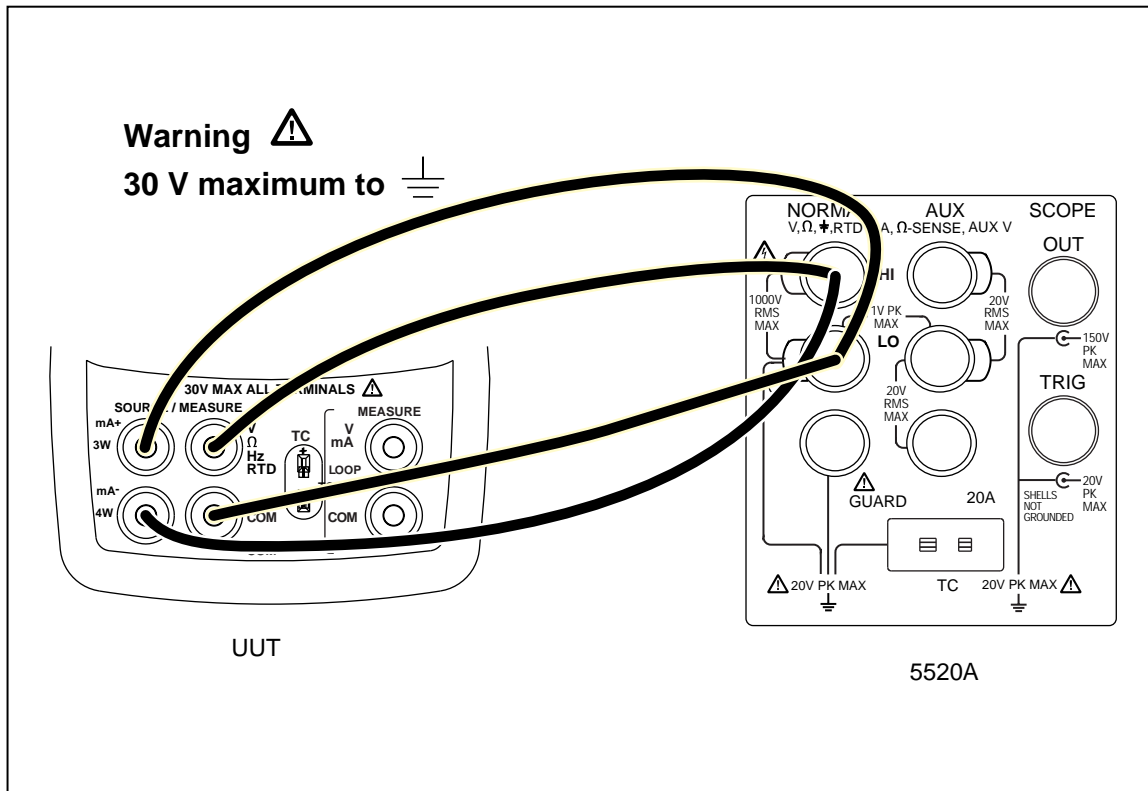

**Figure 21. RTD Low Range Calibration Connections**

aal09f.eps

From the Calibration Menu, enter the cal step for Cal RTD Low Range. The PC displays:

```
Apply 15 ohms to 4 wire jacks
press space bar to continue
```

Set the Fluke 5520A to output 15.00 Ohms, 2-wire output with 2-wire comp off, then press the space bar on the PC. After a short while, the PC displays:

```
Apply 350 ohms to 4 wire jacks
press space bar to continue
```

Set the Fluke 5520A to output 350.00 Ohms then press the space bar on the PC. After a short while, the Calibrator will return to the Calibration Menu.

**Cal RTD Hi Range**

The UUT connection is the same as Cal RTD Low Range, it is shown in Figure 21.

From the Calibration Menu, enter the cal step for Cal RTD Hi Range. The PC displays:

```
Apply 500 ohms to 4 wire jacks
```

```
press space bar to continue
```

Set the Fluke 5520A to output 500.0 Ohms, 2-wire output with 2-wire comp off, then press the space bar on the PC. After a short while, the PC displays:

```
Apply 3200 ohms to 4 wire jacks
```

```
press space bar to continue
```

Set the Fluke 5520A to output 3200.0 Ohms, then press the space bar on the PC. After a short while, the Calibrator will return to the Calibration Menu.

**Cal ISO Volts**

Connect the UUT as shown in Figure 22.

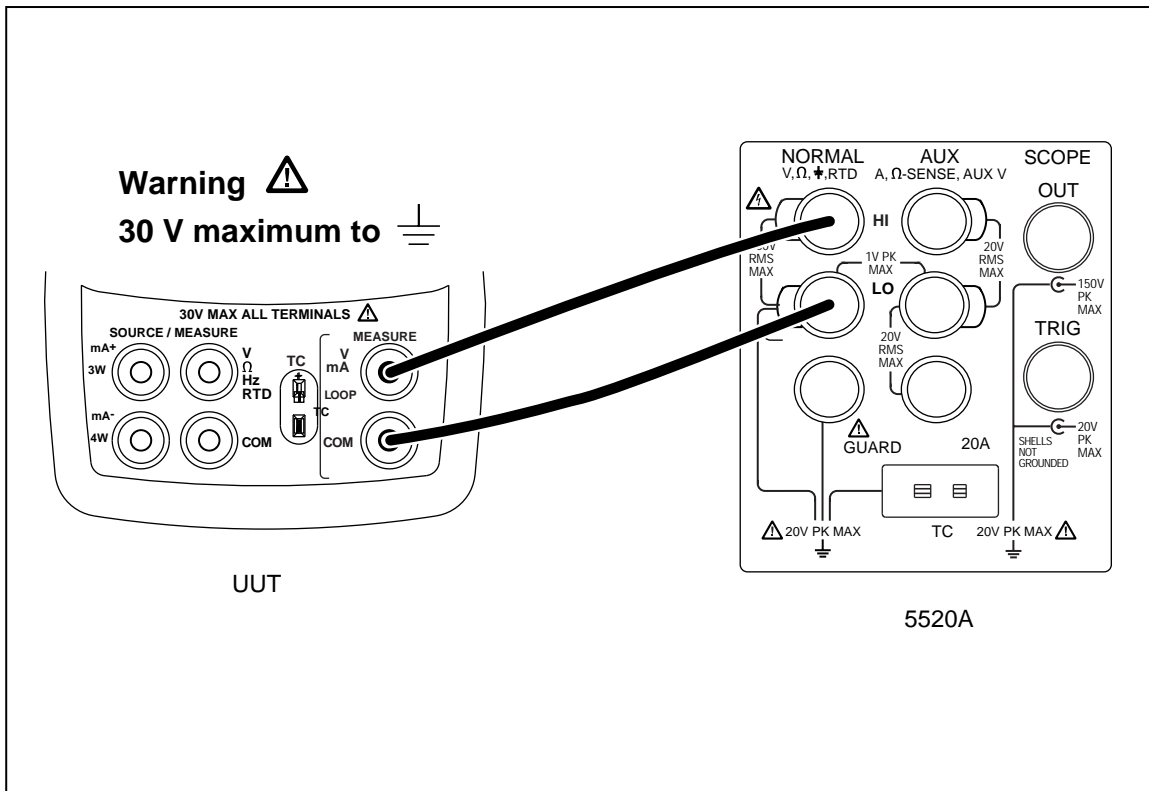

**Figure 22. ISO Volts Calibration Connections**

aal03f.eps

From the Calibration Menu, enter the cal step for Cal ISO Volts. The PC displays:

```
Enter 0 Volts - press space bar to continue
```

Set the Fluke 5520A to output 0.0000 V, then press the space bar on the PC. After a short while the PC displays the following a calibration constant and new prompt:

```
Offset = -324
Enter 30.00 Volts - press space bar to continue
```

Set the Fluke 5520A to output 30.0000 V, then press the space bar on the PC. After a short while, the PC displays the following calibration constants and prompt:

```
diff = (Counts - Offset)
30700 = 30376 - -324
Volts per count = 0.000977
- press space bar to continue
```

Press the space bar to return to the Calibration Menu.

### Cal ISO mA

Connect the UUT as shown in Figure 23.

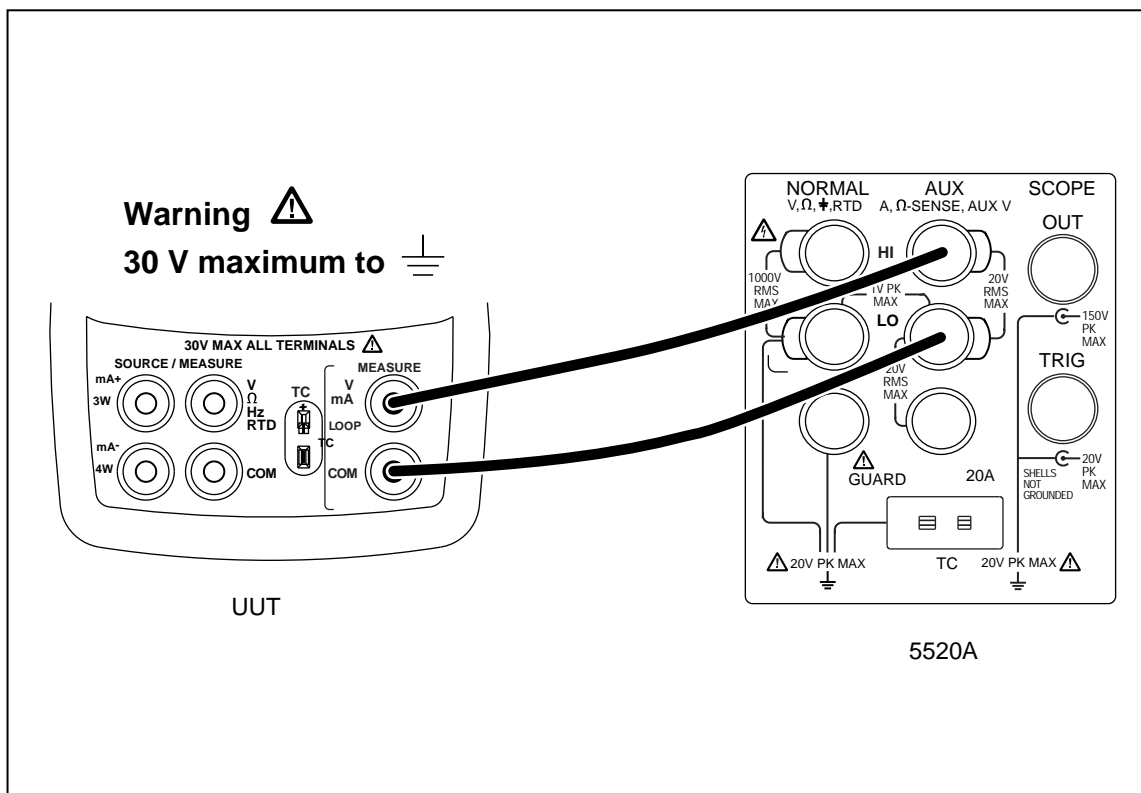

Figure 23. ISO mA Calibration Connections

aal05f.eps

From the Calibration Menu, enter the cal step for Cal ISO mA. The PC displays:

```
Enter 0 ma - press space bar to continue
```

Set the Fluke 5520A to output 0.0000 mA. After a short while, the PC displays the following calibration constants and prompt:

```
Offset = -323
Enter 24.00 ma - press space bar to continue
```

Set the Fluke 5520A to output 24.0000 mA then press the space bar on the PC. After a short while, the PC displays the following calibration constants:

```
diff = (Counts - Offset)
32133 = 31810 - -323
mA per count = 0.000747
- press space bar to continue
```

Press the space bar to return to the Calibration Menu.

Adjustment is completed. Turn the UUT off, then back on, to return to normal operation.

## Replaceable Parts

When servicing this Calibrator, use only the replacement parts specified. User-replaceable parts are listed in Table 20 and shown in Figure 24.

**Table 20. Replacement Parts**

Item	Description	Fluke No.	Quantity
①	Case top	664232	1
②	724 LCD mask	1548383	1
	725 LCD mask	664273	1
③	Elastomeric strips	802063	2
④	724 Input/output bracket	1549921	1
	725 Input/output bracket	691391	1
⑤	LCD bracket	658390	1
⑥	Mounting screws	494641	11
⑦	Backlight	690336	1
⑧	LCD	690963	1
⑨	724 Keypad	1548126	1
	725 Keypad	690955	1
⑩	Case bottom	664235	1
⑪	AA alkaline batteries	376756	4
⑫	Case screws	832246	4
⑬	Battery door	664250	1
⑭	Accessory mount	658424	1
⑮	Tilt stand	659026	1
⑯	Battery door 1/4-turn fasteners	948609	2
⑰	TL75 series test leads	855742	1
⑱	Test lead, red	688051	1
	Test lead, black	688066	1
⑲	AC70A alligator clip, red	738047	1
	AC70A alligator clip, black	738120	1
⑳	724 Case top decal	1548329	1
	725 Case top decal	690948	1

Table 20. Replacement Parts (cont.)

Item	Description	Fluke No.	Quantity
21	724 Product Overview	1547851	1
	725 Product Overview	1549644	1
22	724 CD-ROM (contains Users Manual)	1547849	1
	725 CD-ROM (contains Users Manual)	1549615	1
Not shown	700SC serial interface cable	667425	Optional accessory

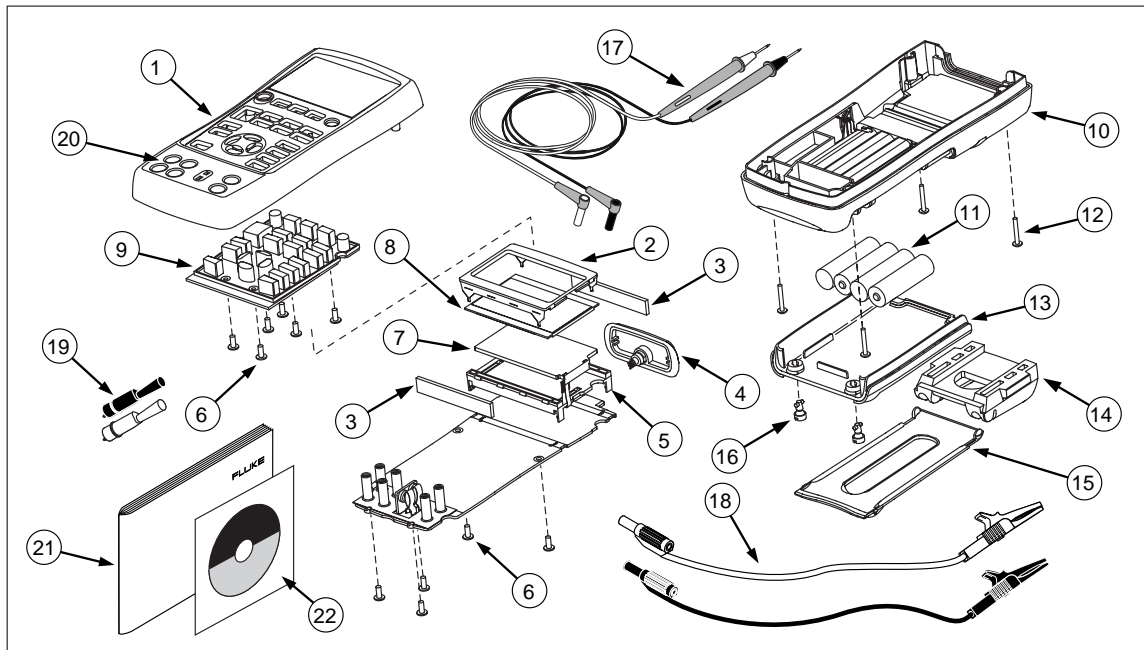

aal02f.eps

Figure 24. Replacement Parts