



Megger®

SPI225

Smart primary injection test system

SPI225

Smart primary injection test system



- Up to 2000A output
- Smallest primary injection test system in its class
- First unit on the market to eliminate variac control
- Output current regulation
- Designed for switchgear commissioning, circuit breaker, CT commissioning, ground grid and relay testing
- Software includes thousands of circuit breaker TCC curves

DESCRIPTION

The Model SPI225 is a high current primary injection test system for all forms of high current testing required in a substation, including testing overcurrent relays, circuit breakers, motor overloads and current transformers.

The SPI system is the FIRST high current test systems to permit a user to type in a predetermined current and the SPI system will generate and regulate the requested high current without preheating the test sample by pulsing the output current at high currents. The SPI system also has the unique ability to turn on at the current zero crossing every time for any load by automatically adjust the output firing angle. This eliminates DC offset for every circuit breaker type and the need for the user to determine and adjust the firing angle for different loads and circuit breakers.

All SPI systems are both fully automated and/or manually controlled. The Smart Touch View Interface "STVI" permits users to manually control the unit and also perform automated testing. The SPI unit can also be controlled by a PC for fully automatic testing and report generation.

APPLICATION

Universal in application, the SPI225 is a high current primary injection test unit with the ability to perform high current commissioning test as well as test low-voltage molded-case circuit breakers. A single SPI225 is designed to test low-voltage molded-case circuit breakers up to a rating of 225A.

The SPI225 is the smallest, lightest primary injection test system designed to perform high current testing on switchgear, current transformers and ground fault protection systems and a multitude of other high current testing applications.

FEATURES AND BENEFITS

Smart Touch View Interface is a simplified input and control touch screen

A key feature of the SPI system is the simplified touch screen input. The STVI touch screen input eliminates the confusing menu system of other primary injection and circuit breaker test systems. The touch screen makes the STVI simple for any technician to use even if the technician does not use the STVI on a consistent basis.

Automatic Control

- The SPI system has many unique abilities to assist in testing
- The user can type a high current setting then the SPI system will generate the requested output without additional user intervention
- Automatically regulate the systems output to the pre-programmed setting
- Automatically regulate the systems output current to compensate for test sample heating or changing load
- Deliver the requested current without user intervention.

Most primary injection system require the user to turn on the system high current then manually adjust the output until the desired test current is set. Once the output is set, the user must still manually adjust the output in order to maintain the desired test current. The SPI system eliminates both of these issues.

Manual Control

The STVI manual controller of the SPI system is sometimes the desire test method. The SPI system permits an operator to run any of the standard test required for primary injection as well as low voltage circuit breakers without the need for a laptop computer.

DC Offset Elimination

DC offset is a common problem when testing instantaneous trips on low voltage circuit breakers. A standard high current test system will commonly cause DC offset in the initial 2 to 4 cycles of an output waveform. This DC offset will cause circuit breakers to trip at incorrect current amplitudes therefore providing incorrect results.

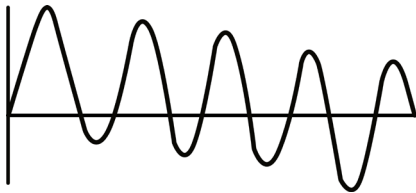

Current Decay

When performing primary injection testing the test leads or test sample will heat up due to the high currents applied. This will result in Current Decay unless the operator manually intervenes. This manual intervention can cause inconsistent test results to the decisions made by the individual operator.

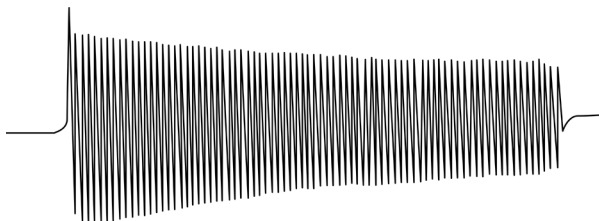

The SPI systems eliminate all these problems by providing a constant current output from the beginning of the waveform until test completion.

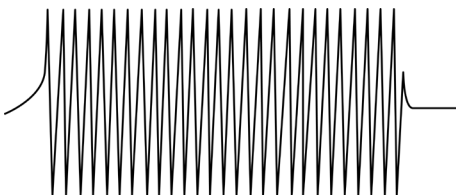

Construction

This test set is built for years of trouble-free, reliable operation. They feature rugged instrumentation and controls designed to withstand the vibration and shock of frequent transportation.

Protection

Fuse, circuit breaker and overload protective devices are incorporated. Temperature sensors provide protection from overheating. Emergency stop pushbutton is provided to de-energize all input power to the test set.

Test	Mult	Current	Phase A (found) (left)	Phase B (found) (left)	Phase C (found) (left)
Pickup (A)		800	1,140	1,240	820
Timing (ms)			59.8	59.8	59.8

SPI Software

SPI software is the premier software for automated testing, report generation and maintenance record keeping of all primary injection and low voltage circuit breaker test. These results are then recorded in the Power DB database for archival or report generation.

The SPI software is specifically designed for primary injection testing of circuit breakers, relays and other substation equipment. In order to simplify testing the SPI software is pre-loaded with circuit breaker curves in order to permit the user to verify that the circuit breaker under test is operating correctly. Since the SPI software has the curves preloaded the user can test all breaker parameters including:

- Long Time Pick Up
- Long Time Timing
- Short Time Pick Up
- Short Time Timing
- Instantaneous Pick Up
- Ground Fault Pick Up
- Ground Fault Timing

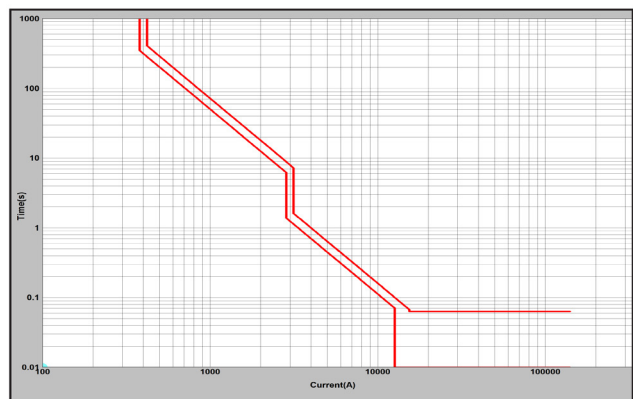

Included complex breaker curves

The SPI software includes report generation for all testing. Thus the user can not only perform all the primary injection testing required but also generate a report for an end customer or for historical purposes.



SPI PRIMARY INJECTION TEST REPORT



PAGE 1

AMBIENT TEMP. 20 °C DATE 11/18/2014

SUBSTATION Electric Utility

HUMIDITY 50 % JOB # _____

POSITION Cubical A

ASSET ID 1245

EQUIPMENT LOCATION _____ Toronto

MANUFACTURER	<u>Cutler-Hammer</u>	SN / SO NO.	_____	FRAME SIZE(F)	<u>150</u>
BREAKER TYPE	<u>Molded Case</u>	SENSOR TAPS	_____	MOUNTING	B.I. <input type="radio"/> D.O. <input type="radio"/>
FUSE CAT. NO.	_____	CUBICLE CODE	_____	THERMAL MEMORY	<input type="radio"/> ON <input type="radio"/> OFF
TRIP UNIT TYPE	<u>Thermal Magnetic</u>	CATALOG NO.	_____	ZONE INTLK	<input type="checkbox"/>
STYLE NUMBER	_____	NUMBER OF POLES	<u>3</u>	TARGETS	<input type="checkbox"/>

ALL TESTS PASSED

Cutler-Hammer/Series-C/EDH/Thermal Magnetic/150 Amps Multi Pole

Manufacturer's Curve number: Curve No. SC-4149-87B

Frame Size: 150
Sensor Rating: 1

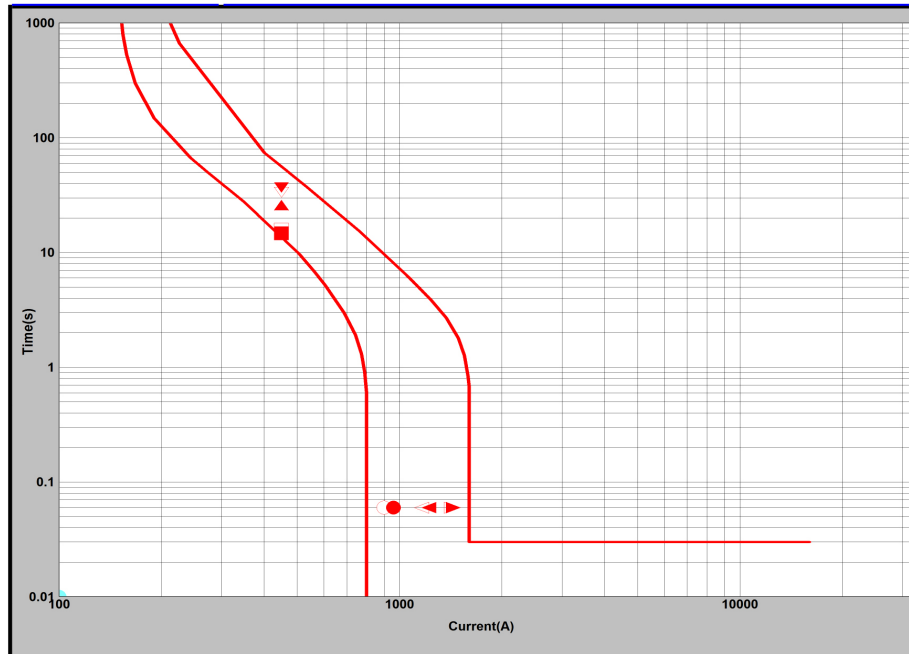

Legend

- A Phase Tim Af
- B Phase Tim Af
- C Phase Tim Af
- A Phase PkUp Af
- B Phase PkUp Af
- C Phase PkUp Af
- A Phase Tim Al
- B Phase Tim Al
- C Phase Tim Al
- A Phase PkUp Al
- B Phase PkUp Al
- C Phase PkUp Al

Test	Nominal I(A)	Multi x	Tolerance		Phase A				Phase B				Phase C				Pass/Fail
			Min (A) or (s)	Max (A) or (s)	As Found		As Left		As Found		As Left		As Found		As Left		
			I (A)	t(s)	I (A)	t(s)	I (A)	t(s)	I (A)	t(s)	I (A)	t(s)	I (A)	t(s)	I (A)	t(s)	
LT Timing	450.00	3.0	13.623	56.012	450.00	15.690	450.00	14.7	450.00	25.820	450.00	25.93	450.00	33.560	450.00	36.78	Pass
Inst Pickup	800.00		800.00	1,600.00	900.00	0.060	960	0.060	1,160.00	0.060	1220	0.060	1,420.00	0.060	1440	0.060	Pass

TEST EQUIPMENT USED: SPI 225(SIM09876451)

TESTED BY: Joe

SPECIFICATIONS

Input

Input Voltage	Input Current	Input Frequency
120 +10% -5%	15A	50 or 60
240 +10% -5%	8A	50 or 60

Output

Output Ranges

Continuously adjustable in three ranges to meet a variety of test circuit impedances:

0 to 500 A at 3.5 V max.

0 to 125 A at 14 V max.

0 to 25 A at 70 V max.

Output Capacity

Percent Rated Current	Maximum Time On	Minimum Time Off
100% (1X)	30 min.	30 min.
200% (2X)	3 min.	8 min.
300% (3X)	30 sec.	4 min.
400% (4X)	7 sec.	2 min.

The output ranges will provide several times their current rating, provided the output voltage is sufficient to push the desired current through the impedance of the test circuit.

The SPI225 will test the time-delay characteristic of thermal devices rated up to 225 A using the recommended test current of three times their rating (675 A). Also, to perform an instantaneous trip test, it will provide 2000 A through a typical 225-ampere, molded-case circuit breaker.

Because the magnitude of the output current is determined by the impedance of the load circuit, the voltage rating must be sufficient to push the desired current through the device under test and the connecting test leads.

Ammeter (digital model)

Operating Mode: Memory, Continuous

Digital Display: Autoranging display 5-digit

Ranges: 1.0000 A to 99.999 kA

Overall Ammeter System: Continuous $\pm 1\%$ of reading

Accuracy: RMS Pulse $\pm 1.5\%$ of reading

Timer range

Digital Display: 5-digit Autoranging display

Ranges: 0.001 to 99999 seconds

0.01 to 99999 cycles

Accuracy: $\pm 1\%$ of reading

Voltmeter (digital model)

Digital Display: 5-digit Autoranging display

Ranges: 0.01 to 600.00 Volts

Accuracy: $\pm 1\%$ of reading

Communications port

Ethernet (2), USB, Bluetooth

Dimensions

14.2 W x 7.6 H x 12.0 D in.

(360 W x 194 H x 305 D mm)

Weight

44.0 lb. (20 kg)

Operating temperature range and humidity

Operating: 0° C to 50° C

Storage: -30° C to 70° C

Humidity: 0 to 90% Non Condensing

Regulatory

Safety: CSA, CE, IEC 61010

ACCESSORIES

Included Standard Accessories	Quantity	Part Number
Accessory carry case	1	2001-487
Alligator clip, red	1	684006
Alligator clip, black	1	684007
Sleeved test leads, one red, one black, 200 cm (78.7") long, 600 V, 32 Amperes CAT II	1	2001-394
Current Lead, AWG#6, 61cm (2 ft) long	1	1004-728
Current Lead, AWG 2/0, 61cm (2 ft) long, red	1	1003-865
Current Lead, AWG 2/0, 61cm (2 ft) long, black	1	1003-866
High Current Alligator Clamp Assembly, 100A	2	1003-863
High Current Alligator Clamp Assembly, 75A	2	1003-864
High Current Probe, dia 7.6mm (0.3 in)	2	2003-732
High Current Probe, dia 5.1mm (0.2 in)	2	2003-733
High Current Probe, dia 3.2 mm (0.125 in)	2	2003-734
Ethernet cable for interconnection to PC, 210cm (7 ft.) long	1	90003-684
SPI Software and Manual on USB Stick	1	83404

Power Cord - Depending on the style number, the unit will come with one of the following:

A = Line cord, North American	1	620000
C = Line cord, Continental Europe with CEE 7/7 Schuko Plug	1	50425
I = Line cord, International color coded wire	1	15065
U = Line cord, United Kingdom	1	90002-989

Optional Accessories	Part Number
Smart Touch View Interface	STVI-1

ACCESSORY DESCRIPTIONS



2001-487

Accessory carry case

Used to carry power cord, Ethernet cable, Optional STVI and test leads.



684006

Alligator clip, red

Alligator clip, red, 4.1 mm, use with test leads up to 1000 V/32 Amps CAT III. Excellent for test connections to terminal screws and pins where spade lugs cannot be used.



684007

Alligator clip, black

Alligator clip, black, 4.1 mm, use with test leads up to 1000 V/32 Amps CAT III. Excellent for test connections to terminal screws and pins where spade lugs cannot be used.



2001-394

Sleeved pair of test leads

Sleeved test leads, one red, one black, 200 cm (78.7") long, 600 V, 32 Amperes CAT II

Sleeved test leads in pairs will reduce tangling. These leads and alligator clips are used when the 25A 70V output tap is used. This lead set allows the user to utilize the maximum output compliance voltage.



1004-728

Current Lead

Current Lead, AWG#6, 61cm (2 ft) long



1003-865

Current Lead, red

Current Lead, AWG 2/0, 61cm (2 ft) long, red



1003-866

Current Lead, black

Current Lead, AWG 2/0, 61cm (2 ft) long, black

The 2/0 high current leads allow the SPI to generate the maximum current specified. These leads also include Megger's unique adapters to allow connection to multiple breaker styles. The AWG #6 high current lead is used with the SPI's 125A 14V output tap. This lead is used when 14V output compliance voltage is required.



1003-863
High Current Alligator Clamp

High Current Alligator Clamp Assembly, 100A



1003-864
High Current Alligator Clamp

High Current Alligator Clamp Assembly, 75A

Megger's high current alligator clips are used with Megger's high current leads to all fast connection to circuit breakers with tab terminations.



2003-732
High Current Probe

High Current Probe, dia 7.6mm (0.3 in)



2003-733
High Current Probe

High Current Probe, dia 5.1mm (0.2 in)



2003-734
High Current Probe

High Current Probe, dia 3.2 mm (0.125 in)

Megger's high current probes are used with Megger's high current leads to allow fast connection to circuit breakers lug terminations.



90003-684
Ethernet cable

Ethernet cable for interconnection to PC, 210cm (7 ft.) long



83404
SPI Software

SPI Software and Manual on USB Stick



620000
Power Cord

Line cord, North American



50425
Power Cord

Line cord, Continental Europe with CEE 7/7 Schuko Plug

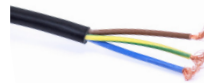

15065
Power Cord

Line cord, International color coded wire



90002-989
Power Cord

Line cord, United Kingdom

There are three optional power cords to choose from. Depending on the destination country, customers can choose which type of power cord they want the unit to come with.

For customers in North America, Central America, Japan, Philippines, South Korea, Taiwan, Thailand, Venezuela, Virgin Islands, and 24 other different countries and territories that use standard NEMA type power outlets of 100, 110, 115 or 120 volts at 50/60 Hz. should order a unit with the standard North American power cord. Enter A for the North American Power Cord.

For customers in Australia/New Zealand, Argentina, China, Denmark, India/South Africa, Ireland, Israel, Russia, Switzerland, or the United Kingdom that have more unique power connectors, will require a power cord which comes with international color coded wires (light blue, brown and green with yellow stripe) with the insulation jacket stripped ready for installation of the appropriate male connector. Enter I for the International Power Cord.

For customers in Austria, Belgium, Finland, France, Germany, the Netherlands, Norway, Portugal, Spain, Sweden, Turkey, and 31 other countries and territories where the CEE 7 standard connector is used should order a unit with the Continental European Power Cord with CEE 7/7 Schuko plug. Enter E for the Continental Europe Power Cord.

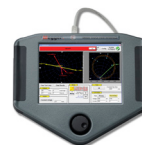

STVI-1
Smart Touch View Interface

Smart Touch View Interface for SMRT33, SMRT36, SMRT36D, SMRT410, and SPI225

This option allows the user to control the SPI unit without the need for a PC.

ORDERING INFORMATION

STYLE NUMBER IDENTIFICATION

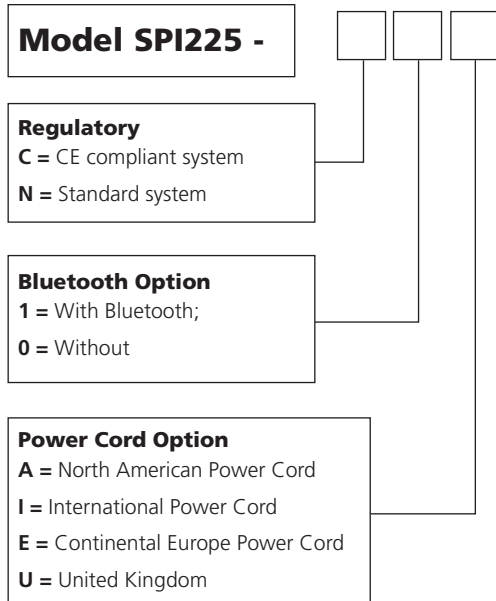

UK
Archcliffe Road Dover
CT17 9EN England
T +44 (0) 1304 502101
F +44 (0) 1304 207342
UKsales@megger.com

UNITED STATES
4271 Bronze Way
Dallas TX 75237-1019 USA
T 800 723 2861 (USA only)
T +1 214 333 3201
F +1 214 331 7399
USsales@megger.com

OTHER TECHNICAL SALES OFFICES
Valley Forge USA, College Station USA,
Sydney AUSTRALIA, Danderyd SWEDEN,
Ontario CANADA, Trappes FRANCE,
Oberursel GERMANY, Aargau SWITZERLAND,
Kingdom of BAHRAIN, Mumbai INDIA,
Johannesburg SOUTH AFRICA, Chonburi THAILAND

CERTIFICATION ISO
Registered to ISO 9001:2000 Cert. no. Q 09290
Registered to ISO 14001-1996 Cert. no. EMS 61597
SPI225_DS_EN_V02
www.megger.com
Megger is a registered trademark