



Advanced Test Equipment Corp.

www.atecorp.com 800-404-ATEC (2832)

4314Ki

Wide-Range Digital Igniter Tester

Operation Manual

Rev 67.3



VALHALLA
SCIENTIFIC

● 2021 Valhalla Scientific. All Rights Reserved.

VALHALLA SCIENTIFIC INC. CERTIFICATION

Valhalla Scientific, Inc. certifies that this instrument was thoroughly tested and inspected and found to meet published specifications when shipped from the factory. Valhalla Scientific, Inc. further certifies that its calibration measurements are traceable to the Nation Institute of Standards and Technology to the extent allowed by NIST's calibration facility.

Due to continuing product refinement and due to possible parts manufacturer changes, Valhalla Scientific, Inc. reserve the rights to change any or all specifications without notice.

VALHALLA SCIENTIFIC INC. WARRANTY STATEMENT

The warranty period for this instrument is stated on your invoice and packing list. Please refer to these to determine appropriate warranty dates.

We will repair the instrument during the warranty period provided it is returned to Valhalla Scientific, Inc. freight prepaid. No other warranty is expressed or implied.

Valhalla Scientific, Inc. is not liable for consequential damages.

Permission and a Return Material Authorization number (RMA) must be obtained directly from the factory for warranty repairs. No liability will be accepted if returned without such permission.

Due to continuing product refinement and due to possible parts manufacturer change, Valhalla Scientific reserves the right to change any or all specifications without notice.

SUPPORT

For repair and calibration services, call 800-548-9806 or visit valhallascientific.com.

Email support available at support@valhallascientific.com



4314Ki Programmable Digital Igniter Tester User Manual
Revision 67-3 (2022)
Copyright © 2022 Valhalla Scientific, Inc. All rights reserved

WARNINGS

The following general safety precautions must be observed during all phases of operation, service, and repair of this product. Failure to comply with these precautions or with specific warnings elsewhere in this manual violates safety standards of design, manufacture, and intended use of the product. Valhalla Scientific assumes no liability for the customer's failure to comply with these requirements.

Ground the equipment: For Safety class 1 equipment (equipment having a protective earth terminal), an interrupted safety earth ground must be provided from the main power source to the product input wiring terminals or supplied power cable.

DO NOT operate the product in an explosive atmosphere or in presence of flammable gases or fumes.

For continued protection, replace the line fuse(s) only with fuse(s) of the same voltage and current rating and type. **DO NOT** use repaired fuses or short-circuited fuse holders.

Keep away from live circuits: Operating personnel must not remove equipment covers or shields. Procedures involving the removal of covers or shields are for the use of service-trained personnel only. Under certain conditions, dangerous voltage may exist even with the equipment switched off. To avoid dangerous electrical shock, **DO NOT** perform procedures involving cover or shield removal unless you are qualified to do so.

DO NOT operate damaged equipment: Whenever it is possible that the safety protection features built into this product have been impaired, either through physical damage, excessive moisture, or any other reason, **REMOVE POWER** and do not use the product until safe operation can be verified by service-trained personnel. If necessary, return the product to Valhalla Scientific for service and repair to ensure that safety features are maintained.

DO NOT service or adjust alone: Do not attempt internal service or adjustment unless another person, capable of rendering first aid and resuscitation, is present.

DO NOT substitute parts or modify equipment: Because of the danger of introducing additional hazards, do not install substitute parts or perform any unauthorized modification to the product. Return the product to Valhalla Scientific for service and repair to ensure that safety features are maintained.

Measuring high voltage is always hazardous: ALL multimeters input terminals (both front and rear) must be considered hazardous whenever inputs greater than 42V (dc or peak) are connected to ANY input terminal.

Permanent wiring of hazardous voltage or sources capable of delivering greater than 150VA should be labeled, fused, or in some other way protected against accidental bridging or equipment failure.

DO NOT leave measurement terminals energized when not in use.

Table of Contents

Table of Contents.....	3
1. General Information	6
Instrument Description	6
Instrument Identification.....	6
Safety Precautions	6
2. Unpacking and Installing.....	7
Inspection.....	7
Power Requirements	7
Installation	7
3. Specifications	8
Range/Resolution/Test Current/Failsafe Current.....	8
<i>Accuracy</i>	8
Temperature	9
General Specifications.....	9
Physical Specifications	9
4. Features and Operations	10
Introduction	10
Front Panel.....	10
Power Switch	10
Display.....	11
Range Selection Keys	12
Source and Sense Post	12
Rear Panel	13
Fuse Holder	13
Charger/Power Receptacle	13
RS-232 Connector	13
Power Mode Switch	13
Power Up	14
Dual Power Mode	14
Connecting a Load to the 4314Ki.....	16
4-Wire Resistance Measurement	16
Interpreting the Display	18

Fail-Safe Operation	18
Low Battery Indicator.....	19
5. Optional Features and Accessories.....	20
Options.....	20
Accessories.....	20
A2: Battery Charger.....	20
Replacement Batteries.....	20
Test Leads	20
Alligator Clip Type Leads.....	20
Needle Type Probes	21
Surface Probes	21
Other Lead Sets.....	21
6. Remote Operations.....	22
Safety Isolated RS-232 Interface.....	22
Connecting the 4314Ki via RS232	22
COMMANDS AND SYNTAX.....	23
DETAILS OF COMMAND REFERENCE.....	23
7. Routine Maintenance	28
General.....	28
Required Test Equipment	28
Precision Resistors:	28
Test Leads:	28
Voltage Standard:	28
DMM:	28
Power Supply:	28
Calibration Procedure	29
VOLTAGE SENSE ADJUSTMENTS	29
SOURCE ADJUSTMENTS	31
FAILSAFE CHECK.....	31
Checking the Calibration Results	32
½ Scale and Linearity Check.....	32
Zero Check.....	32
Battery Replacement Instructions	32

8. Addendum..... 33

1. General Information

Instrument Description

Welcome to a new era of Protection. Featuring the intrinsically safe internal circuitry of our storied 4314 Igniter Tester line, the 4314Ki begins the next generation of precision measurement instruments.

Covering a wide 8-measurement range, the 4314Ki is an ideal fit for the aerospace, defense, renewable energy, and manufacturing industries. This unit can easily replace multiple other instruments while providing clearer, more useful data. Some applications include squib circuits, fuses, release mechanisms, thrust vector motor control, deployment systems, pyrotechnic initiators, primers, and generic circuitry continuity testing.

As in the past, safety and reliability have been the fundamental focus throughout the conception, prototyping, and testing process. Externally, the unit is housed in a durable, impact-resistant aluminum case built for both laboratory and field use. Internally, the 4314Ki incorporates our redundant fail-safe, current-limiting network circuitry ensuring the instrument test currents cannot exceed the specified amount, even in the unlikely event of a worst-case component failure.

Additionally, the 4314Ki introduces Dual Power Mode and an Isolated Serial Interface. Dual Power Mode offers the operator either 18 hours of battery life or a 24/7 continuous power mode with the ability to change via a key switch on the rear of the unit. The isolated serial interface allows for remote control of the unit through an RS-232 port on the back panel. Digital signals are transmitted across the isolation barrier using iCoupler technology. Via the interface, the user can fully operate the meter and query measurement and configuration data.

Please read this manual thoroughly and all accompanying addendums before attempting to operate this ohmmeter.

Instrument Identification

Valhalla Scientific instruments are identified by a two-part serial number. The Serial Tag is located on the rear or bottom of the instrument. The number is in a form of 67-0000. The first two digits, called the serial number prefix, indicate the model. It changes only when a change is made to the instrument. The last 4 digits, called the serial number suffix, are unique for each individual unit.

Be sure to include the entire serial number, both prefix and suffix, in any correspondence about your instrument.

Safety Precautions

For an increased level of safety, plug the 4314Ki into a power source only while charging the batteries or in Continuous Power Mode.

Do not switch between power modes while the device is powered on.

2. Unpacking and Installing

Inspection

If the shipping carton is damaged, request that the carrier's agent be present when the unit is unpacked. If the instrument appears damaged, the carrier's agent should authorize repairs before the unit is returned to the factory. Even if the instrument appears undamaged, it may have suffered internal damage in transit that may not be evident until the unit is operated or tested to verify conformance with its specifications. If the unit fails to operate or fails to meet the performance specifications, notify the carrier's agent and the nearest Valhalla Sales Office. Retain the shipping carton for the carrier's inspection. DO NOT return equipment to Valhalla Scientific, Inc., or any of its sales offices prior to obtaining authorization to do so.

Power Requirements

The Model 4314Ki is powered by four internal rechargeable heavy-duty Nickel–metal hydride (NiMH) batteries. The batteries are charged by an external AC/DC converter that plugs into a standard receptacle. The AC adapter can accept an input voltage from 100 to 240 Vac (50-60Hz) and an output of 9VDC @ 305mA.

The 4314Ki can also support supplies from 6V to 9Vdc @ 300mA to 1.25A.

The unit is equipped with a 2A Fast Blow fuse installed on the rear panel.

To charge the batteries, the device must be:

1. In Battery Mode
2. Turned Off
3. Connected to the Power Supply/Charger.

The battery pack may power the 4314Ki for up to 18 hours before requiring a recharge.

Although the batteries are fully charged prior to shipment, it may be desirable to refresh the charge for 24 hours before use. It takes approximately 16 hours to fully charge the batteries. Do not leave the unit plugged in for extended periods (24+ hours)

In Continuous Power Mode, the 4314Ki will function uninterrupted while connected to the power supply. While in this mode, the batteries are not under charge, even is the device is turned off.

Installation

The Model 4314Ki consumes little power and generates virtually no heat. Consequently, it may be used in any area where the environment does not exceed the temperature specifications of Chapter 3.

3. Specifications

This section contains accuracy and operational specifications for the Model 4314Ki. The accuracy specifications are valid for a period of one year from the date of calibration at a temperature of 15°C (59°F) to 35°C (95°F). Outside this range, the temperature coefficient specification applies.

Range/Resolution/Test Current/Failsafe Current

Table 1

Range Value	2Ω	20Ω	200Ω	2kΩ	20kΩ	200kΩ	2MΩ	20MΩ	Standby
Resolution	100μΩ	1mΩ	10mΩ	100mΩ	1Ω	10Ω	100Ω	1kΩ	-
Test Current	5mA	5mA	500μA	50μA	5μA	500nA	50nA	5nA	0A
Fail-Safe Current ^[1]	8mA	8mA	1.8mA	180μA	18μA	1.8μA	180nA	18nA	-

[1] Maximum value. Actual Failsafe Currents vary from instrument to instrument. The actual measured level is provided on the certificate of calibration.

Accuracy

Table 2

Range	Accuracy
2Ω	±0.03% of reading ± 0.02% of range
20Ω	±0.03% of reading ± 0.02% of range
200Ω	±0.03% of reading ± 0.02% of range
2kΩ	±0.03% of reading ± 0.02% of range
20kΩ	±0.03% of reading ± 0.02% of range
200kΩ	±0.05% of reading ± 0.05% of range
2MΩ	±1% of reading ± 0.2% of range
20MΩ	±2% of reading ± 0.2% of range

Temperature

Temperature Coefficient:	$\pm 0.002\%$ per °C (from 0°C-15°C and 35°C-50°C) <i>not applicable for 200kΩ range and above.</i>
Operating Temperature Range:	0°C to 50°C
Storage Temperature Range:	-10°C to 70°C

General Specifications

Display Type:	4 ½ digits OLED (19999)
Overload Indication:	Screen displays "O.L."
Conversion Rate:	3 readings per second
Terminal Configuration:	4-Wire Kelvin
Current Source Compliance Voltage:	Clamped at 1.6V
Power:	(4 "D" Cell) 1.2V rechargeable NiMH Batteries 10000mAh
Battery Charger:	Provides 6VDC at 1.25A nominal

Physical Specifications

Width:	9.75" / 24.8cm
Depth:	11.5" / 29.2cm
Height:	3.5" / 8.9cm
Weight:	6.2lbs / 2.8kg net

4. Features and Operations

Introduction

This chapter covers the fundamentals of Igniter Tester operation. It shows how to use the 4314Ki front and rear panels, how to make connections, and describes the display sections and messages. Before using the instrument to make measurements, it is important to familiarize yourself with each section of the front and rear panel of the 4314Ki.

Front Panel

The front panel of the 4314Ki can be broken down into 4 parts. In Figure 1 you can see the regions indicated by their name.

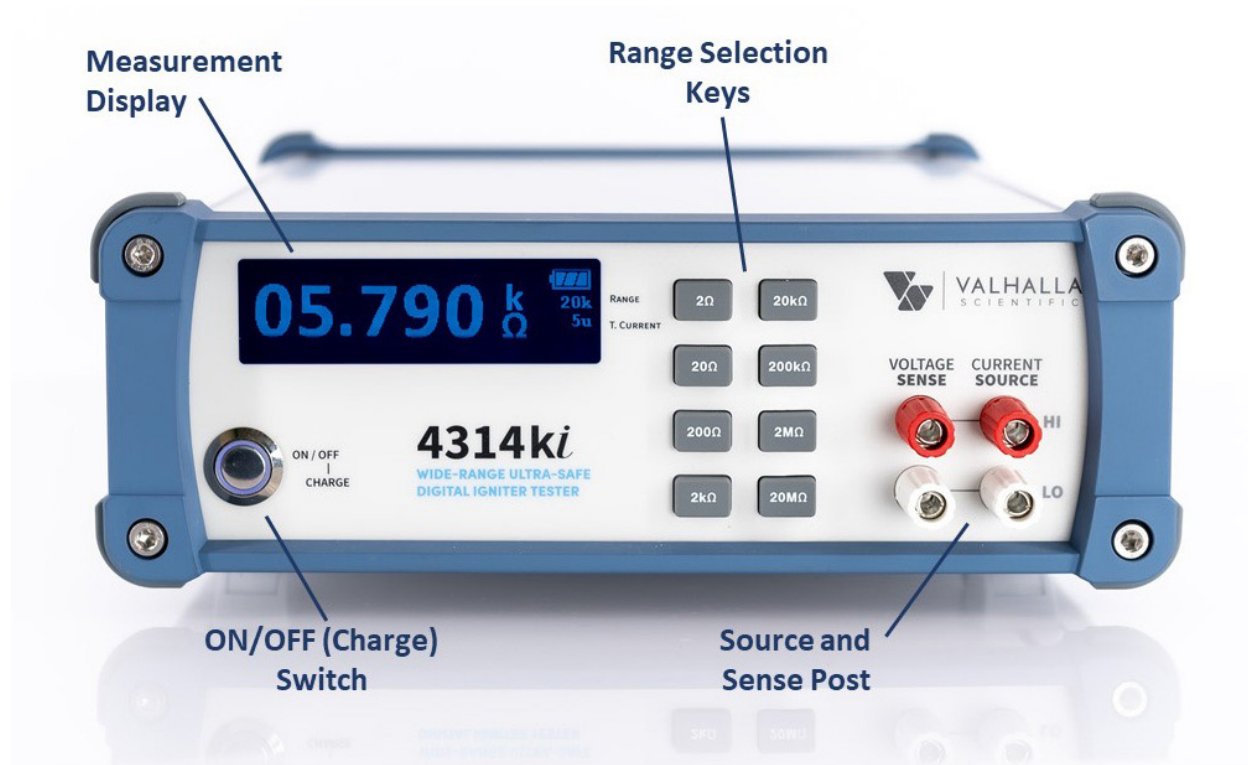

Figure 1 - 4314Ki Front Panel Callouts

Power Switch

Battery Mode: When the front panel power switch is placed in the OFF/CHARGE position, all power is removed from the output terminals, and the battery pack is connected to the charging circuit. When the switch is placed in the ON position, the battery pack is disconnected from the charging circuit. The possibility of a common mode voltage between the device under test and AC Power ground is therefore eliminated. The switch also functions as a low battery indicator. When battery level is within operational limits, the switch will illuminate in blue. Once the battery voltage level drops below the minimum operational limit, the switch will change to red.

Continuous Power Mode: The switch is simply used to turn the 4314Ki on and off.

Display

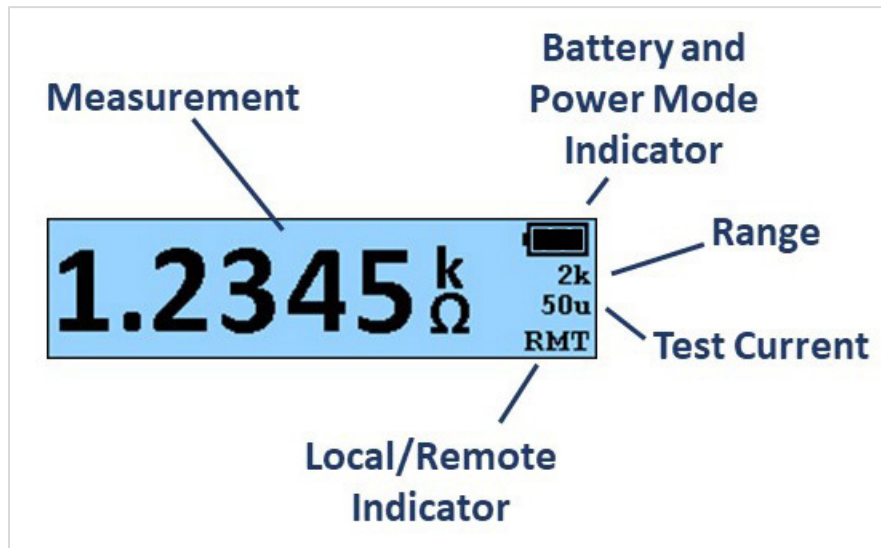

During measurements, the display presents 4 sections.



Measurement

Under normal operations, the Ohms display will indicate the value of the resistance being measured. The multiplier will indicate whether the value displayed is in Ohms, kOhms or MOhms. (ohms, kilo-ohms or mega-ohms).

Battery and Power Mode Indicator

	Indicates that the device is in battery mode.
	Indicates that the device is in battery mode and low battery is detected. Readings should not be trusted. A 16 hour recharge should be performed before using the 4314Ki.
	Indicates that the device is in Continuous Power Mode.

Range and Test Current

Indicates the range selected and the test current level used.

Local/Remote Indicator

This section of the display indicates the remote/local state of the instrument. If RMT is displayed, the instrument is in remote state and can only receive commands through its remote interface port. If the section is blank, the 4314Ki is in local state and will receive commands from the front panel keys.

Range Selection Keys

The eight range keys allow the user to select the required measurement range of the instrument. Each key is labeled with the respective range value.



Source and Sense Post

Connections to the 4314Ki are made via the front panel source/sense terminals, consisting of two red and two black standard binding posts. The posts can accept standard banana plugs, wires up to 12 AWG, or spade lugs. The four terminals provide full 4-Wire Kelvin measurement capability. The right posts are the positive and negative current source terminals and provide the test current, while the left posts are the positive and negative voltage sense terminals used to monitor the voltage drop across the load.

The 4-Wire Kelvin configuration eliminates errors normally caused by test lead and contact resistances. In many applications, the contact resistance can exceed the value of the load by several orders of magnitude. The 4314Ki bypasses this potential error source by providing two terminals of constant current and an additional two terminals for high impedance voltage sensing. The result is a fast, accurate resistance measurement of the load, independent of the resistance of the current carrying leads. Later in this chapter we will illustrate how the 4-wire principle is used to eliminate lead, wire, and contact resistances as potential error sources.

Rear Panel

The rear panel of the 4314Ki may vary from unit to unit based on the features installed. If the 4314Ki that you are using features terminals or connectors that are not described in this section, please refer to any available addendum that references the particularities of your model.

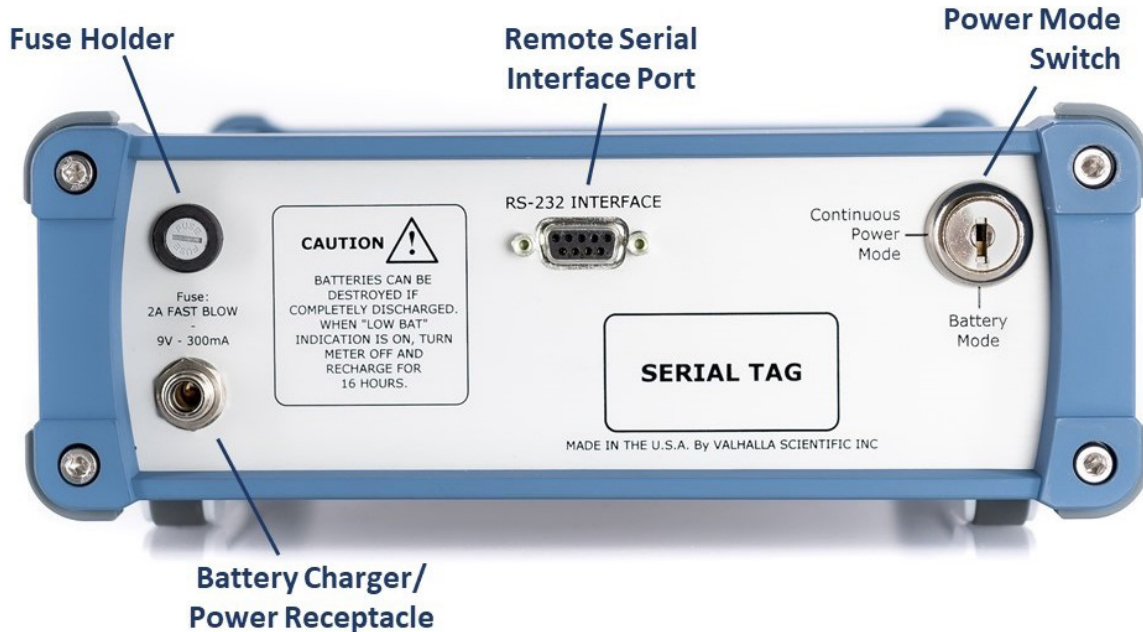

Fuse Holder

The fuse holder is mounted on the rear panel and contains a 2 amp in-line fuse. This fuse is designed to protect the battery pack from excessive charging currents. For continued protection, replace the line fuse only with fuse of the same voltage and current rating and type. DO NOT use repaired fuses or short-circuited fuse holders.

Charger/Power Receptacle

The battery charging jack is a barrel type and is located on the 4314Ki rear panel. The center pin of the connector is positive. The charging requirements of the internal battery pack are 6VDC @ 1.25A. The correct charging voltage is supplied by the adapter included with the instrument. Additional adapters are available as Option "A2". The charger is equipped with a locking ring and is sealed IP68.

RS-232 Connector

The RS-232 interface of the 4314Ki is an ultra-safe isolated serial Interface. The digital signals are transmitted across the isolation barrier using iCoupler technology. The RS-232 serial interfacing is done through the 9-pin female D-Sub connector located on the rear panel of the instrument. Knowledge of the specific pin functions of the serial connector may be necessary for certain applications; see chapter 6 (Remote Interface) for connector pin assignment.

Power Mode Switch

Power Mode Selection Key Switch allows the use to select Battery or Continuous Power Mode.

Power Up

Before applying power, please refer to chapter 2.

Turn on the 4314Ki by pressing the power switch into the ON position. The switch will illuminate blue (or red if the batteries are low). If the device does not turn on, check the line power fuse. If the fuse is intact, switch the device off and charge the batteries for 16 hours.

Once you have turned on the 4314Ki, it will start its power-on routine. The screen will display the following messages:

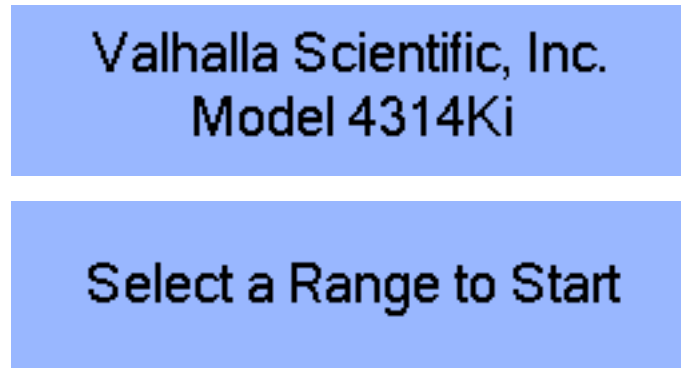

In this state, the device does not output test current. To continue, the user can manually select a range from the front panel keypad or send a range command via the serial interface.

It is important to note that in the power up (or Standby) state, the 4314Ki will only respond to a keypress, a range select command, or an identification query.

Dual Power Mode

The 4314Ki introduces Dual Power Mode offering the operator either up to 16 hours of battery life or a 24/7 continuous power mode. The user can change power mode via a key switch on the rear of the unit (described in the previous section). The key switch acts as an additional safety feature, preventing non-authorized users from changing modes.

The key can only be inserted or removed while in Battery Mode position.



To place the 4314Ki in Continuous Power Mode, turn the key clockwise to a horizontal position. In this position, the key cannot be removed.

To return the device back to Battery Mode, turn the key counterwise to a vertical position. In this position, the key can be removed to permanently lock the 4314Ki in Battery Mode.



WARNING! – ALWAYS TURN THE 4314Ki OFF BEFORE CHANGING POWER MODES.

The user can easily detect the mode selected by looking at the symbol in the top right corner of the display.

	<p>Indicates that the device is in Battery Mode</p>
	<p>Indicates that the device is in Continuous Power Mode.</p>





When in Battery Mode, the 4314Ki runs on 4 NiMH D Cell batteries. The batteries are charged only while the device is in battery mode and turned off. An internal safety line isolation switch disables the battery charging circuit when the 4314Ki is ON. All power is removed from the source circuitry when the unit is OFF and in charging mode.

In Continuous Power Mode, the 4314Ki is powered via the provided power supply (also used as a battery charger). This configuration is a safe option for applications that require longer testing times.

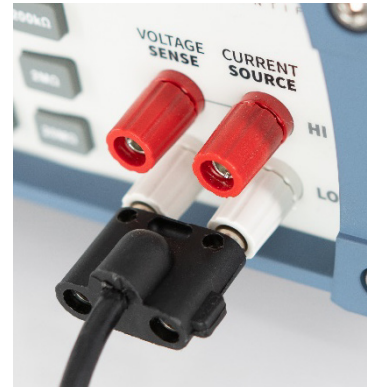
Connecting a Load to the 4314Ki

Connections are made to the front panel terminals using a 4-wire configuration as described in **4-Wire Resistance Measurement**. When using Valhalla test leads, the tabbed side of the banana jack is plugged into the current terminals. This ensures that the current is carried in the largest conductor and that the voltage input is shielded.



V_{HI}   I_{HI} ← Tab
 V_{LO}   I_{LO} ← Tab

4-Wire Resistance Measurement

The four-terminal configuration of the 4314Ki eliminates errors normally caused by test lead and contact resistances. In many applications, the contact resistance can exceed the value of the load by several orders of magnitude. The 4314Ki bypasses this potential error source by providing two terminals of constant current and an additional two terminals for high impedance voltage measurement. The result is a fast, accurate resistance measurement of the load, independent of the resistance of the current carrying leads.

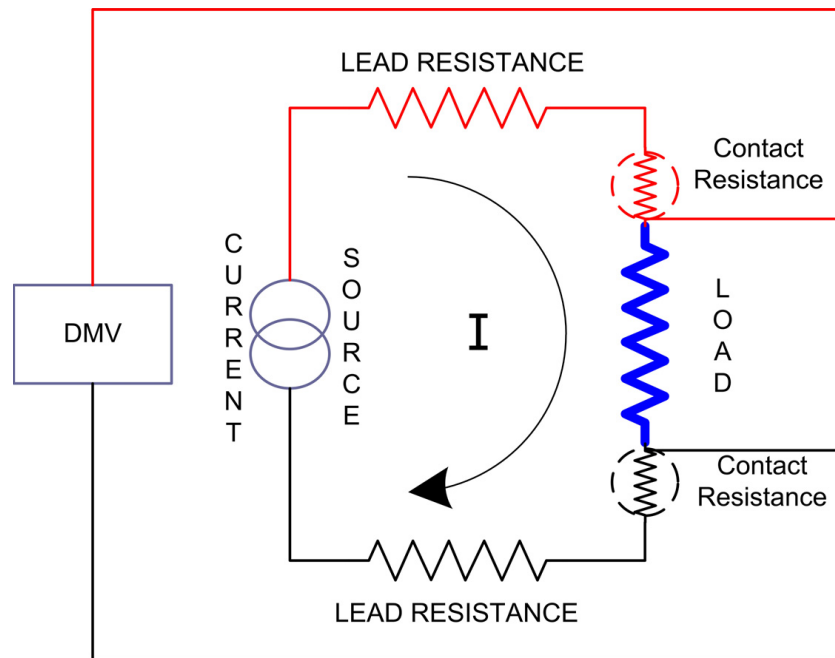

Figure 2 - Error Sources in Resistance Measurements

Figure 2 illustrates how the 4-wire principle is used to eliminate lead, wire, and contact resistances as potential error sources. The internal current source inherently overcomes all series resistance (within compliance voltage limits) and delivers a precise constant current.

The internal high-impedance DVM senses the voltage drop across the load. There is negligible contact and lead resistance error created by the voltage measurement because the high input impedance of the DVM limits current flow in the voltage leads.

The most common termination is alligator type clips. If this is your choice of leads, simply connect one clip to one end of your load and the other clip to the opposite side of the load.



For flat surfaces, you can choose between two different spring-loaded surface probes. If this is your choice of leads, simply press one probe against one side of the surface of your load, making sure that the surface of the probe is in full contact with the surface of the load. Press the second probe against the surface at the opposite side of your load making sure that the surface of the probe is in full contact with the surface of the load.

For hard-to-reach surfaces, Valhalla Scientific offers two sets of spring-loaded dual needle probes differentiated by overall size and distance between the needles. If this is your choice of leads, simply press both the needles of one probe against one end of the surface of your load, press both needles of the second probe against the surface at the opposite end of your load.

See chapter 5 for a full list of lead sets and accessories for your 4314Ki.

Interpreting the Display

All Valhalla ohmmeters and igniter testers use a high impedance voltmeter as part of the resistance measurement process. This voltmeter is a highly accurate and stable 24 bit analog-to-digital converter (ADC). Unless it is receiving a definite input signal, the output reading of this ADC is ambiguous. The display may indicate a randomly wandering number or it may indicate an over-range condition. This unpredictable display may make it seem to appear that the instrument is experiencing some sort of malfunction. It is, in fact, just a characteristic of the voltmeter circuit and should not be mistaken for a fault in the instrument.

The display indications should be ignored unless there is a definite measurement being taken. If this wandering display is not acceptable, the ohmmeter can be made to indicate zero whenever the sense terminals are shorted.

The display should indicate a stable reading when the test leads are securely attached to the device under test. If the display appears to be erroneous when connected to a load, recheck the test leads for integrity and cleanliness. If all external items appear to be functioning properly, the problem may be the ohmmeter. In this case, please contact your local Valhalla Scientific Sales Office.

Fail-Safe Operation

The 4314Ki incorporate a proprietary current source design that renders them incapable of delivering excessive voltage or current to the device under test. Maximum Fail-Safe Current values are list in Table 3.

Range	Fail-Safe Current
2Ω	< 8mA
20Ω	< 8mA
200Ω	< 1.8mA
2kΩ	< 180μA
20kΩ	< 18μA
200kΩ	< 1.8μA
2MΩ	< 180nA
20MΩ	< 18nA

Table 3 - Fail-Safe Current Values per Range

Every 4314Ki Igniter Testers is thoroughly tested before the leaves the factory. This includes a failsafe test that simulates a "worst case" failure condition. The resulting output current is recorded and provided on the Certificate of Calibration included with every unit.

Low Battery Indicator

A standard feature of 4314Ki is circuit monitoring of the internal battery supply output. The Battery Status symbol for this feature is located to the far top/right of the display window.



Indicates that the batteries are low. The unit will remain operational for approximately 5 minutes.

After sensing low batteries, the screen will display “LOW BATTERIES! TURN OFF AND CHARGE”
An overnight recharge should be performed before using the 4314Ki.

5. Optional Features and Accessories

Each 4314Ki Igniter Testers is shipped with a detachable power supply/battery charger (A2) and a set of K 4 wire leads. This section lists several items that may be desirable for special applications.

Options

The 4314Ki comes standard with the Serial Interface and Dual Power Mode switch. However, if required by the application, one or both features can be removed at the factory.

Accessories

A2: Battery Charger

"A2" is an AC/DC converter 115-240VAC line voltage to 9VDC at 300mA with locking ring, sealed IP68. One charger is provided as a standard accessory with every 4314Ki.

Replacement Batteries

The rechargeable NiMH batteries installed in the 4314Ki should provide years of trouble-free operation. Replacement, however, will eventually be necessary. The 4314Ki uses four 1.2V cells installed in a reusable battery box. When ordering replacement batteries, please specify Valhalla Stock #05-10117, quantity four (4).

Test Leads

This section details the different test lead sets and connectors available for use with the 4314Ki Igniter Tester. All cables and test leads are manufactured by Valhalla Scientific Inc. and tested before shipping.

Alligator Clip Type Leads

K: Kelvin Lead Set

"K" is a shielded, 4-wire Kelvin cable set, 48 inches in length terminated in gold plated alligator clips (*KCS*). Option "K" is the recommended general purpose lead set for most applications. *Figure 3*.

KCS: Gold-Plated Clips

"KCS" are gold-plated alligator clips used on the "K" lead set for 4-wire measurements of smaller components and leads. Clips open to 1/2 inch and accommodate test currents of up to 10A.

C: Banana-to-Clip Cable

"C" is a 48" general purpose shielded lead set terminated on one end in dual banana plugs and on the other end in red and black alligator clips.



Figure 3 – K: Kelvin 4-Wire Lead Set

KK: Heavy-Duty Lead Set

"KK" is a 4-wire Kelvin cable set, 48-inches in length terminated in heavy-duty gold-plated clamps. *Figure 4.*

JAWS: Gold-Plated Clamps

"JAWS" are gold-plated heavy-duty clamps. Clamps open to 2 inches for connection to large motors, bushings, etc.



Figure 4 - KK: Kelvin 4-Wire Lead Set

Needle Type Probes

MP-1: Kelvin Micro-Probes

"MP-1" is a 48-inch shielded 4-wire Kelvin cable set with a 1A test current capacity employing a set of Kelvin Micro-Probes. The probes are equipped with spring-loaded stainless-steel tips with 0.05" spacing.

MP-2: Kelvin Mini-Probes

"MP-2" is a 48-inch shielded 4-wire Kelvin cable set with a 1A test current capacity employing a set of Kelvin Mini-Probes. The probes are equipped with spring-loaded stainless-steel tips with 0.18" spacing.

MP-S: Single Pointed Probe Set

"MP-S" is a 48-inch shielded cable set with a 1A test current capacity employing a set of single pointed handheld pencil type probes. (2 wires to each point).

Surface Probes

MP-4: Surface Probes

These probes permit rapid, repeatable bonding testing on a variety of screened or flat surfaces. Test current is evenly distributed through the probe base while sensing is accomplished via a spring-loaded center contact. The target area is 1-inch in diameter. *Figure 5*

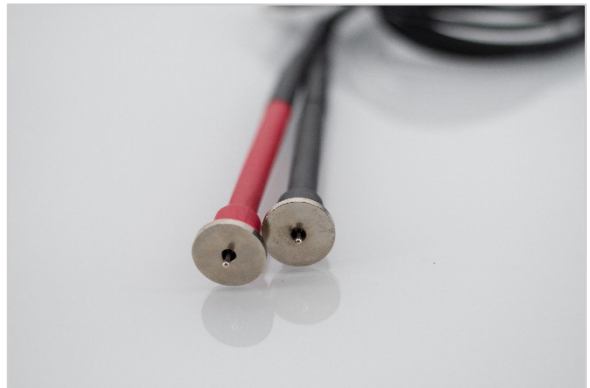

Figure 5 - MP-4 Surface Probe

MP-5: Surface Probes

These probes permit rapid, repeatable bonding testing on a variety of screened or flat surfaces. Test current is evenly distributed through the probe base while sensing is accomplished via a spring-loaded center contact. The target area is ½ inch in diameter.

Other Lead Sets

BBL: Banana-to-Banana Cable

"BBL" is a 48" shielded cable terminated on both ends in dual stacking banana plugs. This cable may be used for voltage and current connections to the ohmmeter.

SL-48: Low Thermal Leads

"SL-48" is a 48" shielded lead set terminated in gold-plated spade lugs. This lead set is designed to eliminate problems caused by thermal EMF's and is rated for the maximum output current of 1A.

6. Remote Operations

Safety Isolated RS-232 Interface

The RS-232 interface of the 4314Ki Igniter Testers is an ultra-safe isolated serial Interface. The digital signals are transmitted across the isolation barrier using iCoupler technology. The interface provides a safe way to communicate with the device via a computer or PLC and allows the transfer of single reading or continuous transmission of data.

Connecting the 4314Ki via RS232

The RS232 interface capabilities:

The RS232 interface provides a point-to-point connection between two items of equipment such as a computer and the 4314Ki. There are some parameters you need to set on both sides. Once you have set these parameters, you can communicate with the 4314Ki through the RS232 interface.

- Baud rate: 115200 baud.
- Parity bit: none.
- Data bit: 8 bits.
- Stop bit: 1 stop bit.
- Data flow control: none.

Notes for RS232 installation

The 4314Ki is a DCE (Data Channel Equipment) device with a 9-pin D-type shell RS232 connector located on the rear panel. Table 4 shows the 9-pin connector (Female) with its pin number assignments.

Pin #	Pin Function
1	No Connection
2	Receive Data (RxD) (input)
3	Transmit Data (TxD) (output)
4	No Connection
5	Signal Ground
6	No Connection
7	No Connection
8	No Connection
9	No Connection



Table 4 - Connector Pin Configuration

Checking Connections

To test whether the RS232 connection is working, you can send a command from the computer. For instance, using a terminal program send the query command

```
Idn?
```

The device should return the Manufacturer, model number, firmware version in the following format:

```
Valhalla Scientific 4314Ki V1.0
```

If you do not receive a proper response from the 4314Ki, please check if the power is on, and all cable connections are active.

COMMANDS AND SYNTAX

RS232 message terminators

As there is no signal of end message on RS232 bus, therefore, use LF, CR, or CR/LF as message terminator. After the 4314Ki processes a command, a CR/LF is placed in the output buffer and delivered. As for query command, the return message of the instrument is also added an LF for PC to judge message terminator.

Entering Commands

The standards that govern the command set for the 4314Ki allow for a certain amount of flexibility when you enter commands. The 4314Ki does not adhere to any friendly listening standards, so the commands and queries must be typed as specified. The 4314Ki is sensitive to the case of command characters. Specifically, the device uses the Camel Case.

DETAILS OF COMMAND REFERENCE

Each command in this chapter will give a detailed description. The examples of each command will be provided, and what query form might return.

Remote mode is entered when a valid printable character is received and is exited with the LOCAL front panel key or LOCAL command.

Command Index

Idn?	LogOff	Serial?
Local	Ohms?	SetRange
LogON	RangeN?	Screen?
LogOn0	RangeV?	Standby
LogOn2	Reset	

Idn? QUERY

Returns the RS-232 identification string from non-volatile.

Syntax: Idn?<crlf>

Response: ID string "Valhalla Scientific 4314Ki v1.0"

Example: Idn? "Valhalla Scientific 4314Ki v1.0"

ID_STRING : "Valhalla Scientific"

MODEL : "4314Ki"

VERSION : "V1.0"

Local **COMMAND**

Returns meter to local mode.

Syntax: Local<crLf>

Returns: <crLf>

Power-on default = LOCAL mode

Notes: REMOTE mode is selected when the meter receives a valid character (not <crLf>).

LogOn **COMMAND**

Turns on continuous reading mode synonymous with "Ohms?". Note: if the devices is already Logging, the LogOn command will return "Invalid Command"

Syntax: LogOn<crLf>

Returns: Measurement Value + Multiplier every 300ms.

Example for 2Ω Range: 1.2345
Example for 20Ω Range: 12.345
Example for 200Ω Range: 123.45
Example for 2kΩ Range: 1.2345k
Example for 20kΩ Range: 12.345k
Example for 200kΩ Range: 123.45k
Example for 2MΩ Range: 1.2345M
Example for 20MΩ Range: 12.345M

LogOn0 **COMMAND**

Turns on continuous reading mode synonymous with "Ohms?". Note: if the devices is already Logging, the LogOn0 command will return "Invalid Command"

Syntax: LogOn0<crLf>

Returns: Measurement Value + Multiplier every 500ms.

Example for 2Ω Range: 1.2345
Example for 20Ω Range: 12.345
Example for 200Ω Range: 123.45
Example for 2kΩ Range: 1.2345k
Example for 20kΩ Range: 12.345k
Example for 200kΩ Range: 123.45k
Example for 2MΩ Range: 1.2345M
Example for 20MΩ Range: 12.345M

LogOn2 **COMMAND**

Turns on continuous reading mode synonymous with "Screen? + RangeV?".
Note: if the device is already Logging, the LogOn2 command will return "Invalid Command"

Syntax: LogOn2<crLf>

Returns: Screen data + the value of the range every 500ms.

Example for 2Ω Range: 1.2345<crLf>2
Example for 20Ω Range: 12.345<crLf>20
Example for 200Ω Range: 123.45<crLf>200
Example for 2kΩ Range: 1.2345<crLf>2k
Example for 20kΩ Range: 12.345<crLf>20k
Example for 200kΩ Range: 123.45<crLf>200k
Example for 2MΩ Range: 1.2345<crLf>2M

LogOff **COMMAND**

Stops continuous measurement mode.

Syntax: LogOff<crLf>

Response: <crLf>

Ohms? **QUERY**

Responds with the front panel reading formatted in ohms with multiplier.
No leading zeros.

Syntax: Ohms?<crLf>

Returns: Display data in Ohms with multiplier.

Example for a 1.1 ohm reading on:

2Ω Range: 1.1000
20Ω Range: 1.100
200Ω Range: 1.10
2kΩ Range: 0.0011k

RangeN? **QUERY**

Responds with the range number from 1 to 8

Syntax: RangeN?<crLf>

Returns: R# (1-8)

R1	-	2 Ohms Range	R5	-	20k Ohms Range
R2	-	20 Ohms Range	R6	-	200k Ohms Range
R3	-	200 Ohms Range	R7	-	2M Ohms Range
R4	-	2k Ohms Range	R8	-	20M Ohms Range

RangeV? QUERY

Responds with the range value from 2 to 20M

Syntax: RangeV?<crLf>

Returns: 2 - 20M

2	-	2 Ohms Range
20	-	20 Ohms Range
200	-	200 Ohms Range
2k	-	2k Ohms Range
20k	-	20k Ohms Range
200k	-	200k Ohms Range
2M	-	2M Ohms Range
20M	-	20M Ohms Range

Reset COMMAND

Executes a soft reset of the system.

Syntax: Reset<crLf>

Response: <crLf>

Serial? QUERY

Returns the Serial Number of the 4314Ki.

Syntax: Serial?<crLf>

Response: Serial Number string "67-1234"

Example: Serial? "67-1234"

SetRange# COMMAND

Sets range.

Syntax: SetRange#<crLf>

 SetRange# (1-8)

1	-	2 Ohms Range	5	-	20k Ohms Range
2	-	20 Ohms Range	6	-	200k Ohms Range
3	-	200 Ohms Range	7	-	2M Ohms Range
4	-	2k Ohms Range	8	-	20M Ohms Range

Screen? QUERY

Responds with the screen image.

Syntax: Screen?<crLf>

Returns: Display data formatted exactly to the screen.

Example for a 1.1 ohm reading on:

2Ω Range:	1.1000
20Ω Range:	01.100
200Ω Range:	001.10
2kΩ Range:	0001.1

Standby COMMAND

Returns meter to Powerup Screen. (No Current Output)

Syntax: Standby<crLf>

Returns: <crLf>

Power-on default = STANDBY mode

7. Routine Maintenance

General

This section of the manual contains routine maintenance information regarding the Valhalla Scientific Model 4314Ki Digital Igniter Testers. Calibration should be performed on a regular basis to ensure continued instrument accuracy. The recommended calibration interval is 1 year.

Required Test Equipment

Following is a list of the standard resistors and other equipment required to calibrate the 4314Ki.

Precision Resistors:

.1 Ω \pm 0.01% Accuracy

1 Ω \pm 0.005% Accuracy

10 Ω \pm 0.005% Accuracy

100 Ω \pm 0.005% Accuracy

1K Ω \pm 0.005% Accuracy

10K Ω \pm 0.005% Accuracy

100K Ω \pm 0.005% Accuracy

1M Ω \pm 0.005% Accuracy

10M Ω \pm 0.005% Accuracy

Test Leads:

4-Wire Lead Set

(Valhalla Option "K" or "C")

Voltage Standard:

Voltage Calibrator capable of outputting from 0V to negative 75mV, 0.03% Accuracy or better.

DMM:

Model 3458A or equivalent.

Power Supply:

Power supply capable of outputting from 4.6 to 6VDC.

Calibration Procedure

To perform calibration, you will need access to the main board of the device. Remove the top cover screens from the front panel and all four screws from the rear panel. Remove the top cover and replace the bottom two rear panel screws.

VOLTAGE SENSE ADJUSTMENTS

Connection:

Apply voltage at Sense Inputs and short Source and Sense negative Terminals.
On the main board press the CalSwitch (SW202) tact switch to initiate calibration routine.

4314Ki Procedure:

1. Display will prompt:

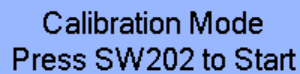

Calibration Mode
Press SW202 to Start

2. Press SW202. Display will prompt:

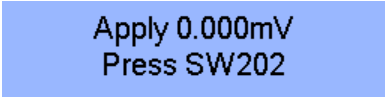

Apply 0.000mV
Press SW202

3. Apply 0.000mV to the Voltage Sense and press SW202 on the Main Board.
Display will prompt:



Calibration in Progress

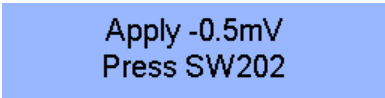

Apply -0.5mV
Press SW202

4. Apply -0.5mV and press SW202.
Display will prompt:

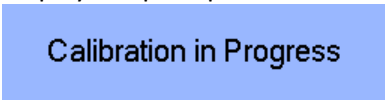

Calibration in Progress

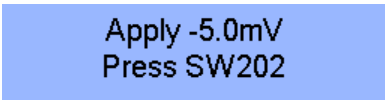

Apply -5.0mV
Press SW202

5. Apply -5.0mV and press SW202.
Display will prompt:

Calibration in Progress

Apply -9.0mV
Press SW202

6. Apply -9.0mV and press SW202.
Display will prompt:

Calibration in Progress

Apply -75.0mV
Press SW202

7. Apply -75.0mV and press SW202.
Display will prompt:

Calibration in Progress

Calibration Complete
Exiting Calibration Mode

Valhalla Scientific, Inc.
Model 4314Ki

Select a Range to Start

Voltage Sense Calibration is complete.

SOURCE ADJUSTMENTS

1. Select 200 Ω range.
2. Connect to a 100 Ω standard resistor.
Adjust RV10 for a display reading equal to the value of the resistor.
3. Select 2k Ω range and connect to a 1k Ω standard resistor.
Adjust RV11 for a display reading equal to the resistor value.
4. Select 20k Ω range and connect to a 10k Ω standard resistor.
Adjust RV12 for a display reading equal to the resistor value.
5. Select 200k Ω range and connect to a 100k Ω standard resistor.
Adjust RV13 for a display reading equal to the resistor value.
6. Select 2M Ω range and connect to a 1M Ω standard resistor.
No adjust. Verify that display reading is within tolerance of the resistor value.
7. Select 20M Ω range and connect to a 10M Ω standard resistor.
No adjust. Verify that display reading is within tolerance of the resistor value.
8. Select 2 Ω range and connect to a 1 Ω standard resistor.
No adjust. Verify that display reading is within tolerance of the resistor value.
9. If the 2 Ω range is too low, select R27 using a Resistance Decade Box.
10. Select 20 Ω range and connect to a 10 Ω standard resistor.
No adjust. Verify that display reading is within tolerance of the resistor value.
11. If the 20 Ω range is too low, select R37 using a Resistance Decade Box.

IMPORTANT: If it is necessary to perform step 9 or 11, go back and forth between the 2 Ω , 20 Ω and 200 Ω ranges until all are in spec.

FAILSAFE CHECK

1. Connect the 3458A in the ammeter mode across the current terminals. Select the 2 Ω range.
2. Short J10 and verify that the measured current is equal or less then the value specified in the Fail-Safe current table.
3. Repeat this process for each range.
4. For M Ω ranges it will be necessary to connect the appropriate calibration resistor and measure the voltage drop across it. Use Ohm's Law to calculate the failsafe current.

Range	Fail-Safe Current
2 Ω	8mA
20 Ω	8mA
200 Ω	1.8mA
2k Ω	180 μ A
20k Ω	18 μ A
200k Ω	1.8 μ A
2M Ω	180nA
20M Ω	18nA

Checking the Calibration Results

½ Scale and Linearity Check

Apply to each range resistor values equal to 50% of range and 5% of range.

All values should be within the tolerance specified in Chapter 3.

Zero Check

1. Apply a short between VHI and VLO.
2. Apply a short between VLO and ILO.
3. Check the display for 0 ± 3 digits

Battery Replacement Instructions

The rechargeable NiMH batteries used in the 4314Ki are very durable and should provide years of trouble-free operation. As with all batteries, a replacement will eventually be necessary. Batteries may be ordered from Valhalla Scientific as stock #05-10117, quantity: (4). If requested, replacement tie-wraps will also be provided.

The process of battery replacement is described below:

Remove the four screws from the rear panel and pull out the battery holder.

1. Cut the tie-wraps that are securing the batteries in place.
2. Remove the old batteries and replace. Observe polarity!
3. Secure the new batteries in place by replacing the tie-wraps.
4. Reinstall the rear panel, taking care not to pinch any wires.

8. Addendum

Immediately following this page may be found any notices regarding manual changes, or operating instructions for the optional interfaces (if installed). Please refer to any applicable material before attempting to operate your ohmmeter. If no items follow this page, your manual is complete as printed.

For repair and calibration services, call 800-548-9806 or visit valhallascientific.com.
Email support available at support@valhallascientific.com

4314Ki Programmable Digital Igniter Tester User Manual
Revision 67-3 (2022)
Copyright © 2022 Valhalla Scientific, Inc. All rights reserved



4314Ki Programmable Digital Igniter Tester User Manual
Revision 67-3 (2022)
Copyright © 2022 Valhalla Scientific, Inc. All rights reserved

