



Advanced Test Equipment Corp.

www.atecorp.com 800-404-ATEC (2832)

AETECHRON



7548/7794/7796/7796HC

Operator's Manual

Single-Channel Industrial Amplifiers for Demanding, High-Power Systems

APPLIES TO UNITS WITH MAINBOARD PART NUMBER 65-7796135-3

574.295.9495 | www.aetechron.com
2507 Warren Street, Elkhart, IN 46516

Three-Year, No-Fault Warranty

SUMMARY OF WARRANTY

AE TECHRON INC., of Elkhart, Indiana (Warrantor) warrants to you, the ORIGINAL COMMERCIAL PURCHASER and ANY SUBSEQUENT OWNER of each NEW **AE TECHRON INC. product, for a period of three (3) years from the date of purchase, by the original purchaser (warranty period) that the product is free of defects in materials and workmanship and will meet or exceed all advertised specifications for such a product. We further warrant the new AE Techron product regardless of the reason for failure, except as excluded in the Warranty.**

ITEMS EXCLUDED FROM WARRANTY

This AE Techron Warranty is in effect only for failure of a new AE Techron product which occurred within the Warranty Period. It does not cover any product which has been damaged because of any intentional misuse, or loss which is covered under any of your insurance contracts. This warranty does not extend to any product on which the serial number has been defaced, altered, or removed. It does not cover damage to loads or any other products or accessories resulting from **AE TECHRON INC.** product failure. It does not cover defects or damage caused by the use of unauthorized modifications, accessories, parts, or service.

WHAT WE WILL DO

We will remedy any defect, regardless of the reason for failure (except as excluded), by repair or replacement, at our sole discretion. Warranty work can only be performed at our authorized service centers or at our factory.

Expenses in remedying the defect will be borne by **AE TECHRON INC.**, including one-way surface freight shipping costs within the United States. (Purchaser must bear the expense of shipping the product between any foreign country and the port of entry in the United States and all taxes, duties, and other customs fees for such foreign shipments.)

HOW TO OBTAIN WARRANTY SERVICE

When you notify us or one of our authorized service centers of your need for warranty service, you will receive an authorization to return the product for service. All components must be shipped in a factory pack or equivalent which, if needed, may be obtained

from us for a nominal charge. We will take corrective actions and return the product to you within three weeks of the date of receipt of the defective product, or will make available to you a product of equal or better performance on temporary loan until your product can be repaired or replaced and returned to you. If the repairs made by us are not satisfactory, notify us immediately.

DISCLAIMER OF CONSEQUENTIAL AND INCIDENTAL DAMAGES

You are not entitled to recover from us any consequential or incidental damages resulting from any defect in our product. This includes any damage to another product or products resulting from such a defect.

WARRANTY ALTERATIONS

No person has the authority to enlarge, amend, or modify this warranty. The warranty is not extended by the length of time for which you are deprived of the use of this product. Repairs and replacement parts provided under the terms of this warranty shall carry only the unexpired portion of this warranty.

DESIGN CHANGES

We reserve the right to change the design of any product from time to time without notice and with no obligation to make corresponding changes in products previously manufactured.

LEGAL REMEDIES OF PURCHASER

There is no warranty that extends beyond the terms hereof. This written warranty is given in lieu of any oral or implied warranties not contained herein. We disclaim all implied warranties, including, without limitation, any warranties of merchantability or fitness for a particular purpose. No action to enforce this Warranty shall be commenced later than ninety (90) days after expiration of the warranty period. This statement of warranty supersedes any others contained in this manual for AE Techron products.

AE TECHRON INC.

Customer Service Department

2507 Warren St. Elkhart, IN, 46516, U.S.A.
(574) 295-9495
www.aetechron.c

DECLARATION OF CONFORMITY

Technical Construction File Route

Issued By: AE Techron, Inc.
2507 Warren Street
Elkhart, IN 46516

For Compliance Questions Only: Larry Shank
574-295-9495
lshank@aetechron.com

This Declaration of Conformity is issued under the sole responsibility of AE Techron, Inc., and belongs to the following product:

Equipment Type: Industrial Power Amplifiers

Model Name: 7548

EMC Standards:

- EN 61326-1: 2013 – Electrical equipment for measurement, control and laboratory use
 - EMC Requirements
- EN 55011: 2009 + A1: 2010 – Industrial, scientific and medical (ISM) radio-frequency equipment:
 - Radio disturbance characteristics
 - Limits and methods of measurement
- EN 61000-4-2: 2009 – Electromagnetic compatibility (EMC) Part 4: Testing and measurement techniques:
 - Electrostatic discharge immunity test
- EN 61000-4-3: 2006 + A2: 2010 – Electromagnetic compatibility (EMC) Part 4: Testing and measurement techniques:
 - Radiated radio-frequency electromagnetic field immunity test
- EN 61000-4-4: 2004 + A1: 2010 – Electromagnetic compatibility (EMC) Part 4: Testing and measurement techniques:
 - Electrical fast transient/burst immunity test
- EN 61000-4-5: 2006 – Electromagnetic compatibility (EMC) Part 4: Testing and measurement techniques:
 - Surge immunity test
- EN 61000-4-6: 2009 – Electromagnetic compatibility (EMC) Part 4: Testing and measurement techniques:
 - Immunity to conducted disturbances induced by radio frequency field
- EN 61000-4-8: 2010 – Electromagnetic compatibility (EMC) Part 4: Testing and measurement techniques:
 - Power frequency magnetic field immunity test

Safety Standard:

BSEN61010-1:2010 (inc Corr. May 2011) – Safety requirements for electrical equipment for measurement, control, and laboratory use

I certify that the product identified above conforms to the requirements of the EMC Council Directive 2004/108/EC (until 19th April, 2016) and Directive 2014/30/EU (from 20th April, 2016), and the Low Voltage Directive 2006/95/EC (until 19th April, 2016) and Directive 2014/35/EU (from 20th April, 2016).

Signed:

Larry Shank
President



Place of Issue: Elkhart, IN, USA
Date of Issue: March 18, 2016

CE Affixing Date: March 4, 2011

DECLARATION OF CONFORMITY

Technical Construction File Route

Issued By: AE Techron, Inc.
2507 Warren Street
Elkhart, IN 46516

For Compliance Questions Only: Larry Shank
574-295-9495
lshank@aetechron.com

This Declaration of Conformity is issued under the sole responsibility of AE Techron, Inc., and belongs to the following product:

Equipment Type: Industrial Power Amplifiers

Model Name: 7794

EMC Standards:

- EN 61326-1: 2013 – Electrical equipment for measurement, control and laboratory use
 - EMC Requirements
- EN 55011: 2009 + A1: 2010 – Industrial, scientific and medical (ISM) radio-frequency equipment:
 - Radio disturbance characteristics
 - Limits and methods of measurement
- EN 61000-4-2: 2009 – Electromagnetic compatibility (EMC) Part 4: Testing and measurement techniques:
 - Electrostatic discharge immunity test
- EN 61000-4-3: 2006 + A2: 2010 – Electromagnetic compatibility (EMC) Part 4: Testing and measurement techniques:
 - Radiated radio-frequency electromagnetic field immunity test
- EN 61000-4-4: 2004 + A1: 2010 – Electromagnetic compatibility (EMC) Part 4: Testing and measurement techniques:
 - Electrical fast transient/burst immunity test
- EN 61000-4-5: 2006 – Electromagnetic compatibility (EMC) Part 4: Testing and measurement techniques:
 - Surge immunity test
- EN 61000-4-6: 2009 – Electromagnetic compatibility (EMC) Part 4: Testing and measurement techniques:
 - Immunity to conducted disturbances induced by radio frequency field
- EN 61000-4-8: 2010 – Electromagnetic compatibility (EMC) Part 4: Testing and measurement techniques:
 - Power frequency magnetic field immunity test

Safety Standard:

BSEN61010-1:2010 (inc Corr. May 2011) – Safety requirements for electrical equipment for measurement, control, and laboratory use

I certify that the product identified above conforms to the requirements of the EMC Council Directive 2004/108/EC (until 19th April, 2016) and Directive 2014/30/EU (from 20th April, 2016), and the Low Voltage Directive 2006/95/EC (until 19th April, 2016) and Directive 2014/35/EU (from 20th April, 2016).

Signed:

Larry Shank
President



Place of Issue: Elkhart, IN, USA
Date of Issue: April 14, 2016

CE Affixing Date: April 14, 2016

DECLARATION OF CONFORMITY

Technical Construction File Route

Issued By: AE Techron, Inc.
2507 Warren Street
Elkhart, IN 46516

For Compliance Questions Only: Larry Shank
574-295-9495
lshank@aetechron.com

This Declaration of Conformity is issued under the sole responsibility of AE Techron, Inc., and belongs to the following product:

Equipment Type: Industrial Power Amplifiers

Model Name: 7796

EMC Standards:

- EN 61326-1: 2013 – Electrical equipment for measurement, control and laboratory use
 - EMC Requirements
- EN 55011: 2009 + A1: 2010 – Industrial, scientific and medical (ISM) radio-frequency equipment:
 - Radio disturbance characteristics
 - Limits and methods of measurement
- EN 61000-4-2: 2009 – Electromagnetic compatibility (EMC) Part 4: Testing and measurement techniques:
 - Electrostatic discharge immunity test
- EN 61000-4-3: 2006 + A2: 2010 – Electromagnetic compatibility (EMC) Part 4: Testing and measurement techniques:
 - Radiated radio-frequency electromagnetic field immunity test
- EN 61000-4-4: 2004 + A1: 2010 – Electromagnetic compatibility (EMC) Part 4: Testing and measurement techniques:
 - Electrical fast transient/burst immunity test
- EN 61000-4-5: 2006 – Electromagnetic compatibility (EMC) Part 4: Testing and measurement techniques:
 - Surge immunity test
- EN 61000-4-6: 2009 – Electromagnetic compatibility (EMC) Part 4: Testing and measurement techniques:
 - Immunity to conducted disturbances induced by radio frequency field
- EN 61000-4-8: 2010 – Electromagnetic compatibility (EMC) Part 4: Testing and measurement techniques:
 - Power frequency magnetic field immunity test

Safety Standard:

- BSEN61010-1:2010 (inc Corr. May 2011) – Safety requirements for electrical equipment for measurement, control, and laboratory use

I certify that the product identified above conforms to the requirements of the EMC Council Directive 2004/108/EC (until 19th April, 2016) and Directive 2014/30/EU (from 20th April, 2016), and the Low Voltage Directive 2006/95/EC (until 19th April, 2016) and Directive 2014/35/EU (from 20th April, 2016).

Signed:

Larry Shank
President



Place of Issue: Elkhart, IN, USA
Date of Issue: March 18, 2016

CE Affixing Date: March 4, 2011

Contents

1	Introduction	7
1.1	Features	7
2	Amplifier Unpacking and Installation	8
2.1	Safety First	8
2.2	Unpacking	8
2.3	Installation	8
2.4	Connecting the Load	9
2.5	Connecting the Input Signal	10
2.6	Connecting the AC Supply	11
2.7	Start-up Procedure	11
3	Amplifier Operation	12
3.1	Front-Panel Controls & Display	12
3.2	Front-Panel Indicators	13
3.3	Back-Panel Controls and Connectors.....	17
4	Advanced Configuration.....	18
4.1	Factory Defaults	18
4.2	Accessing the Main Board.....	18
4.3	Configuration Settings Located on the Main Board.....	18
4.4	Adjusting the Bi-Level Power Supply Switch	21
5	Applications.....	22
5.1	Remote Status and Control using the SIM Interlock I/O Connector	22
5.2	Controlled Current Operation	26
5.3	Multi-amplifier Systems	30
6	Maintenance	31
6.1	Clean Amplifier Filter and Grills	31
7	Troubleshooting	32
7.1	Introduction & Precautions	32
7.2	Visual Inspection	32
7.3	No Signal.....	33
7.4	No LEDs Illuminated or No Fans.....	33
7.5	OverVoltage Warning Message.....	33
7.6	Standby LED Remains Illuminated.....	33
7.7	Amplifier Overheats (Over Temp Fault Condition).....	34
7.8	Fault LED is Illuminated	35
7.9	Factory Service	35
8	Specifications.....	36

List of Figures

Figure 1.1 – 7548 Front Panel.....	7
Figure 2.1 – Connecting the Load	9
Figure 2.2 – Close-up of the Output Terminal Resistor	9
Figure 2.3 – Close-up of SIM card.....	10
Figure 2.4 – Wiring for Unbalanced or Balanced Input Connector	10
Figure 2.5 – 208V 3-Phase AC Mains Wiring	11
Figure 2.6 – 380/400/415V 3-Phase AC Mains Wiring	11
Figure 3.1 – Front Panel Controls and Display.....	12
Figure 3.2 – Front Panel Indicators	13
Figure 3.3 – Main Status Indicators for Stand-Alone Amplifiers	13
Figure 3.4 – Fault Status Indicators for Stand-Alone Amplifiers	14
Figure 3.5 – Main Status Indicators for Multi-Amplifier Systems	15
Figure 3.6 – Fault Status Indicators for Multi-Amplifier Systems.....	16
Figure 3.7 – Back Panel Controls and Connectors	17
Figure 4.1 – Master or Follower Setting	19
Figure 4.2 – Gain Trim Control	19
Figure 4.3 – Controlled-Voltage or Controlled-Current Mode Setting.....	19
Figure 4.4 – Compensation Setting	20
Figure 4.5 – Ready/Run Mode or Standby Mode on Power-Up Setting.....	20
Figure 4.6 – Standby Mode on Overload Setting	20
Figure 4.7 – Bi-Level Power Switch Location	21
Figure 5.1 – Remote Status and Control Pinouts	22
Figure 5.2 – Remote Run/Standby Monitor.....	22
Figure 5.3 – Remote Status and Reset Schematic	23
Figure 5.4 – Remote Enable/Standby	24
Figure 5.5 – Remote Current Monitoring	25
Figure 5.6 – Remote Current Monitoring, Alternate Method.....	25
Figure 5.7 – Input to Output Comparison, Controlled-Voltage Operation.....	26
Figure 5.8 – Input to Output Comparison, Controlled-Current Operation.....	26
Figure 5.9 – Factory-installed Default RC Network	27
Figure 5.10 – Custom Compensation Location	29
Figure 5.11 – Compensation Effects on Waveform	29
Figure 5.12 – Square Wave Showing a Decrease in R is Required.....	29
Figure 5.13 – Square Wave Showing an Increase in R is Required	29
Figure 5.14 – Square Wave Showing an Increase in C is Required	29
Figure 7.1 – +Vcc and –Vcc Point Locations.....	32
Figure 7.2 – Amplifier cover removed for inspection	32
Figure 7.3 – Fuse F1 Location.....	33
Figure 7.4 – Interlock I/O Connector	33
Figure 7.5 – +TEMP and -TEMP test point locations	34



Figure 1.1 – 7548 Front Panel

1 Introduction

Congratulations on your purchase of the 7548, 7794, 7796 or 7796HC AE Techron power amplifier—a single -channel industrial amplifier designed for use in the most demanding high-power systems. The 7548, 7794, 7796 and 7796HC amplifiers are built and tested to the most stringent quality standards for long life and outstanding performance. The AE Techron brand is known throughout the world for its robust precision amplifiers as well as its product service and support.

1.1 Features

The 7548/7794/7796/7796HC, when operated in Controlled Voltage mode, provides precision amplification at frequencies from DC to 30 kHz, and DC to 100 kHz+ at reduced power, with low harmonic and intermodulation distortion and low noise. The 7548/7794/7796/7796HC operates on 208-volt (optional 400-volt, except 7796HC amplifier) 3-phase AC mains. Other features include:

- DC-enabled, four-quadrant, linear amplifier.
- Standard SIM (Specialized Input Module) features unbalanced BNC, balanced Phoenix-type 3-pin input, and 25-pin Interlock – I/O connectors. Optional SIM modules are available or

can be created to provide additional features for unique applications.

- Built-in protection circuitry safely provides for sustained, full-power output. Full protection includes:
 - Over-Voltage
 - Over-Temperature
 - Temperature monitor of heat-sinks, transformers and output transistors
 - Immediate protection and fast recovery in the event of overheating.
- Generous, front-to-back cooling allows tight rack mounting without the need for air spaces and permits longer run times at higher duty cycles.
- Switching, bi-level power supply adapts to meet demands for high voltage or high current.
- Convenient, multi-function front-panel LCD display provides peak and RMS values for voltage and current measured directly from the output of the amplifier. Status indicators, and sealed navigation and input buttons, are also conveniently located on the front panel.

2 Amplifier Unpacking and Installation

The 7548, 7794, 7796 and 7796HC amplifiers are precision instruments that can be dangerous if not handled properly. Lethal voltages are present in both the AC input supply and the output of these amplifiers. For this reason, safety should be your primary concern when you setup and operate this amplifier.

2.1 Safety First

Throughout this manual special emphasis is placed on good safety practices. The following graphics are used to highlight certain topics that require extra precaution.

	DANGER
<p>DANGER represents the most severe hazard alert. Extreme bodily harm or death will occur if these guidelines are not followed. Note the explanation of the hazard and instruction for avoiding it.</p>	
	WARNING
<p>WARNING alerts you to hazards that could result in severe injury or death. Note the explanation of the hazard and the instructions for avoiding it.</p>	
	CAUTION
<p>CAUTION indicates hazards that could result in potential injury or equipment or property damage. Once again, note the explanation of the hazard and the instructions for avoiding it.</p>	

2.2 Unpacking

All amplifiers are tested and inspected for damage before leaving the factory. Carefully unpack and inspect the amplifier for damage. **Please note any damage for future reference and notify the shipping company immediately if damage is found.** Also, please save the shipping carton and materials as evidence of damage and/or for returning the amplifier for repair.

Along with any additional accessories purchased by the customer, all 7548/7794/7796/7796HC amplifiers ship with the following:

- Toolkit (contains one 1/8-inch Allen driver and three 2.7-ohm resistors)
- NEMA connector for Power Cord
- Operator's Manual USB drive and Quick Start sheet

	WARNING
<p>Never attempt to lift the amplifier without assistance. Crushing bodily injury can result if care is not taken during installation. Cabinets may overturn if not secured.</p>	

2.3 Installation

The 7548, 7794, 7796 and 7796HC amplifiers have rack “ears” on each side of the front panel for mounting to a standard EIA (Electronic Industries Association) rack. Use standard rack mounting hardware to mount the amplifier. Use nylon washers if you wish to protect the powder-coat finish on the front of the amplifier.

NOTE: The 7548 weighs approximately 103 pounds, and the 7794, 7796 and 7796HC weigh approximately 153 pounds. Be sure this weight is properly supported using all the screw locations.

When mounting the amplifier in a rack cabinet, the sidewalls of the rack must be at least 2 inches away from the chassis on both sides.

Allow for hot air discharge through the amplifier's rear grill. If your cabinet has a rear door, you must provide adequate airflow through the door. Provide a source of cool air for fan intakes. If the rack is crowded or rack ventilation is poor, use a vent tube to the outside of the rack. Cooling capacity required is 300 ft³/min. total per amp.

When operating the amplifier in a dusty environment, use commercial furnace filters, or equivalent, to prevent rapid clogging of the filters on the amplifier.

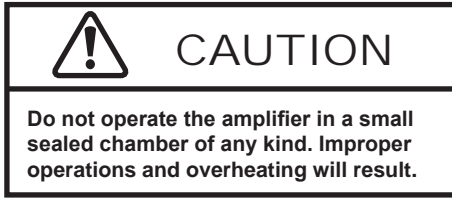

Optionally, the amplifier can be placed on a bench top; please keep in mind that the protective powder-coating can be scratched when placed on other equipment or on a bench top, especially when there is dirt present. To protect the finish, a set of rubber feet is included in the toolkit that can be installed on the bottom of the amplifier.

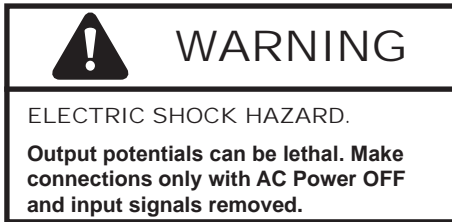

2.4 Connecting the Load

Before connecting the amplifier, make sure the AC power cord is unplugged.

This section describes output wiring to the load when using the default amplifier configuration: Single (or Master) amplifier operated in Controlled Voltage mode. The amplifier also can be field-adjusted for operation in Controlled Current mode or for operation as a Follower amplifier in a multi-amplifier system. These alternate configurations

may require special output wiring and/or additional components.

If your application requires Controlled Current and/or Follower operation, change the default settings on the main board before connecting the amplifier. (See the **Advanced Configuration** section for more information.)

Locate the four-position terminal barrier block labeled OUTPUTS on the amplifier back panel (see **Figure 2.1**).

NOTE: The 7548/7794/7796/7796HC amplifier comes with a factory-installed 2.7-ohm, 2W, 5%, metal-oxide resistor connecting the terminals marked “SAMPLED COMMON” and “CHASSIS GROUND” (see **Figure 2.2**). This resistor should NOT be removed. WARNING: Removing this resistor can cause dangerous output and/or damage to the load unless configuring multiple amplifiers in series. See the **AE Techron Multi-Amplifier Configuration Guide** for more information on these advanced configurations.

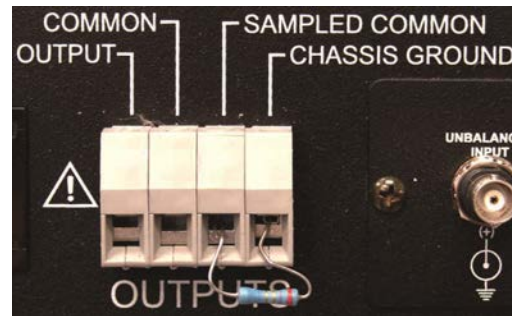

Figure 2.2 – Close-up of the Output Terminal Resistor

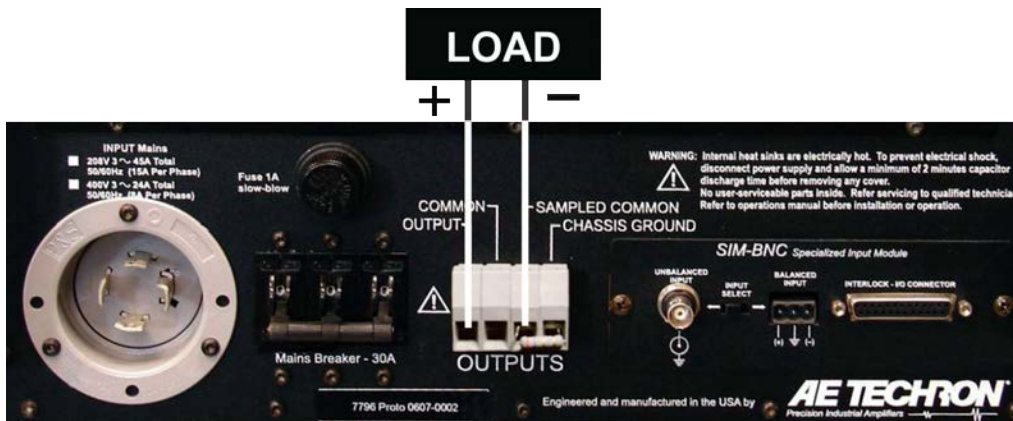

Figure 2.1 – Connecting the Load

2.4.1 Connecting the Outputs

The four-position terminal barrier block accepts up to #4 AWG wire. Always use the appropriate wire size and insulation for the maximum current and voltage expected at the output. Never connect the output of the amplifier to any other model amplifier, power supply, signal source, or other inappropriate load; fire can result.

1. Connect the negative terminal of the load to the SAMPLED COMMON terminal.

NOTE: Alternately, the COMMON terminal may be used when operating in Controlled-Voltage mode; however, the integrated current monitor will not function if the COMMON terminal is used, since it depends on feedback from the Sampled Common terminal. For operation in Controlled-Current mode, the SAMPLED COMMON terminal must be used.

2. Connect the load's positive terminal to the amplifier's OUTPUT terminal.
3. The "CHASSIS GROUND" terminal can be connected to an external ground point such as the rack chassis.

2.5 Connecting the Input Signal

The signal is connected to the amplifier through a "SIM (Specialized Input Module) Card" located

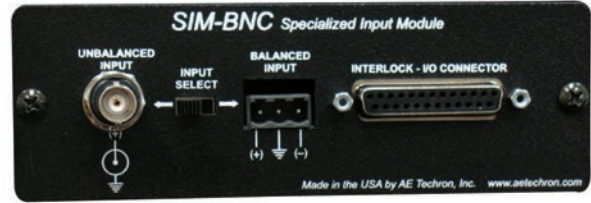

Figure 2.3 – Close-up of SIM card

on the amplifier back panel (see **Figure 2.3**). The standard SIM card includes both an Unbalanced Input BNC jack and a Balanced Input "WECO" terminal block connector, an Input Select switch, and an Interlock – I/O Connector. See the **Applications** section for information on using the Interlock – I/O Connector.

Position the **Input Select** switch to the left to select the Unbalanced Input connector and to the right to select the Balanced Input connector. Note that **when the Input Select switch is in the right position, both Unbalanced and Balanced Input connectors are enabled.**

IMPORTANT: The Input Select switch also functions as a Ground Lift switch for the Unbalanced Input connector. If circulating currents/ground loops/60-Hz Hum occur when using the Unbalanced Input, move the Input Select switch to the right to lift the ground on the connector.

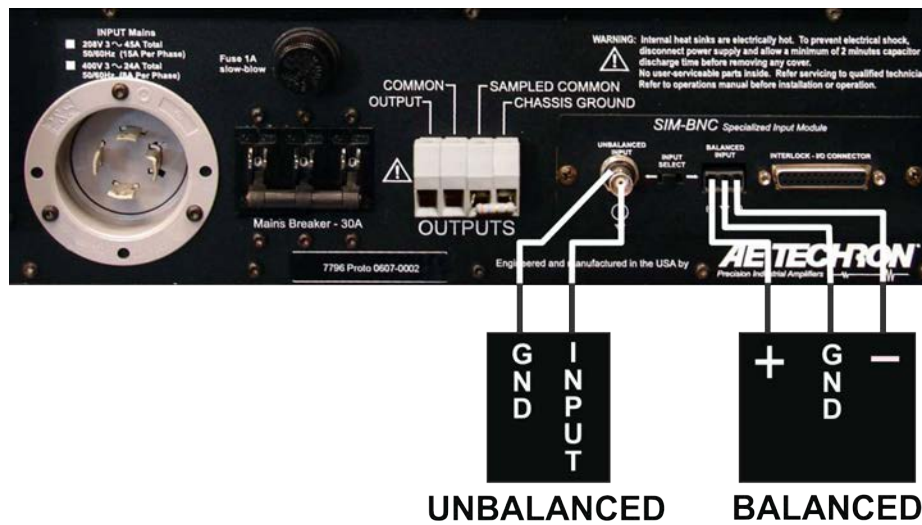
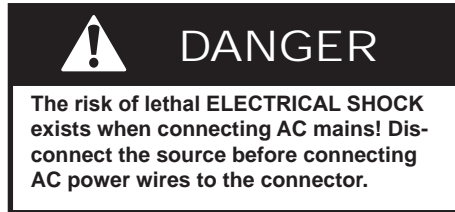

Figure 2.4 – Wiring for Unbalanced or Balanced Input Connector

Connect your input signal to the amplifier's unbalanced or balanced input connector as shown in **Figure 2.4**. Use cables that are high quality and shielded to minimize noise and to guard against possible feedback.



2.6 Connecting the AC Supply

The 7548/7794/7796/7796HC amplifier requires 3-phase wiring. Always operate the amplifier from proper AC mains. The 3-phase, 47 - 60 Hz voltage must be 208 VAC (or optionally 400 VAC, except model 7796HC) with no more than 10% variance above or below the line voltage. The amplifier will not operate properly outside these limits.

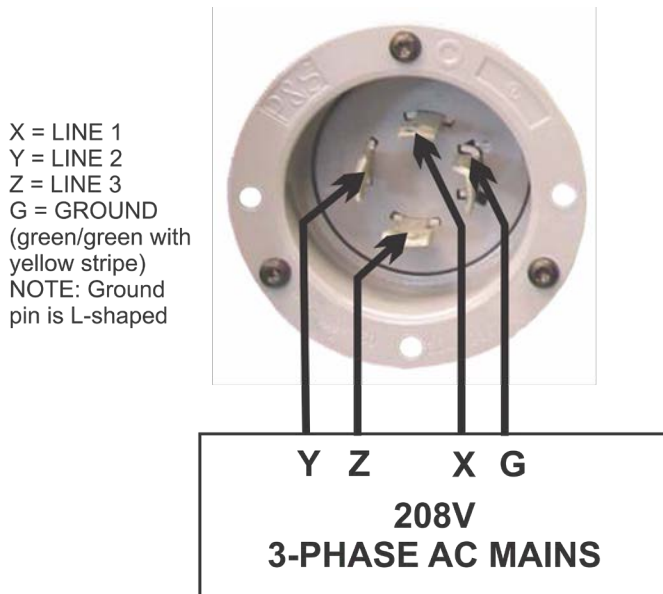

Figure 2.5 – 208V 3-Phase AC Mains Wiring

The amplifier includes a NEMA style locking AC connector as standard equipment. Connect the amplifier to the proper 3-phase AC mains with this connector. See **Figures 2.5 and 2.6** for proper AC Mains wiring. The connector then plugs into the amplifier.

2.7 Start-up Procedure

1. Turn down the level of your signal source.
2. Check to make sure the AC Mains Switch/Circuit Breaker is in the off position (DOWN).
3. Apply AC power to the amplifier.
4. Move the AC Mains Switch/Circuit Breaker to the on position (UP) to turn the amplifier ON. Wait for the amber READY and green RUN LEDs to illuminate.
5. Adjust the level of your input signal source to achieve the desired output level.
6. Use the Navigation Buttons to navigate through the various voltage and current measurement functions on the LCD display.

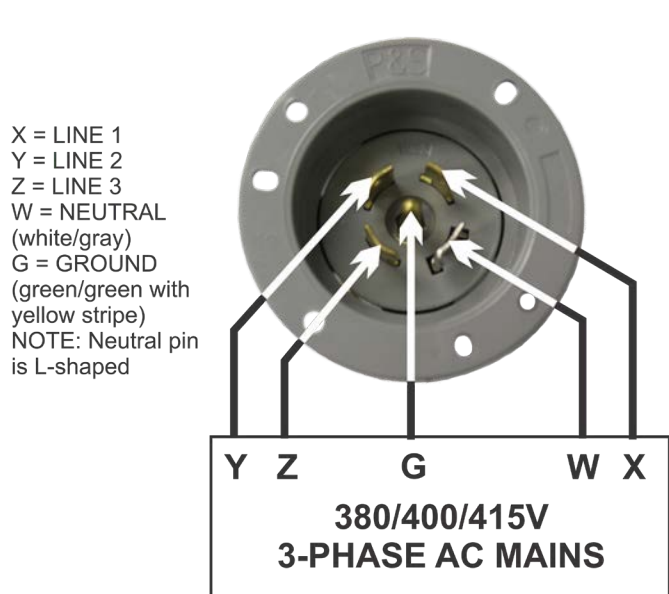

Figure 2.6 – 380/400/415V 3-Phase AC Mains Wiring

3 Amplifier Operation

3.1 Front-Panel Controls & Display

This section provides an overview of Front-Panel controls and display screen found on the 7548/7794/7796/7796HC amplifier. Please refer to **Figure 3.1** for item locations.

3.1.1 Input Buttons

Three Push Buttons on the amplifier front panel control basic operation of the amplifier.

Enable – For stand-alone amplifiers, Enable will release the amplifier from Stop mode and place the amplifier in Run mode (both Ready and Run LEDs will be lit). When the amplifier is placed in Run mode, the amplifier will amplify the input signal. If an amplifier is disabled using a Remote Standby application, the amplifier will be placed in Standby mode (both Ready and Standby LEDs will be lit). To return the amplifier to Run mode, release the Standby condition using the remote switch. See the **Applications** section of this manual for more information on remote amplifier operation.

In multi-amp systems that have been configured to start up in Standby mode, when the Enable button is pressed on one amplifier, the amplifier will be placed in Standby mode and remain in Standby mode until all amplifiers in the system have been Enabled. The system will automatically proceed to Run mode when all amplifiers in the system achieve Standby mode.

Stop – For stand-alone amplifiers, Stop will place the amplifier in Stop mode (both Standby and Stop LEDs will be lit). When the amplifier is part of a multi-amp system, pressing the Stop button on any amplifier in the system will place that amplifier in Stop mode and all other amplifiers in the system in Standby mode. When an amplifier is in Stop or Standby mode, the low-voltage transformer is energized but the high-voltage transformers are not.

Reset – For stand-alone amplifiers, when a fault condition occurs, the amplifier may be placed in Standby mode (Standby LED will be lit), depending on the amplifier configuration and the fault condition. To release the amplifier from Standby mode, clear the fault condition and then press the Reset button. If the amplifier is in Run mode when the fault condition occurs, pressing the Reset button will return the amplifier to Run mode. If the amplifier is in Stop mode when the fault condition occurs, pressing the Reset button will return the amplifier to Stop mode.

When the amplifier is part of a multi-amp system, pressing the Reset button on the amplifier reporting the fault condition will clear the condition and return all amplifiers to Run or Stop mode; pressing the Reset button on other amplifiers in the system will NOT clear the fault condition.

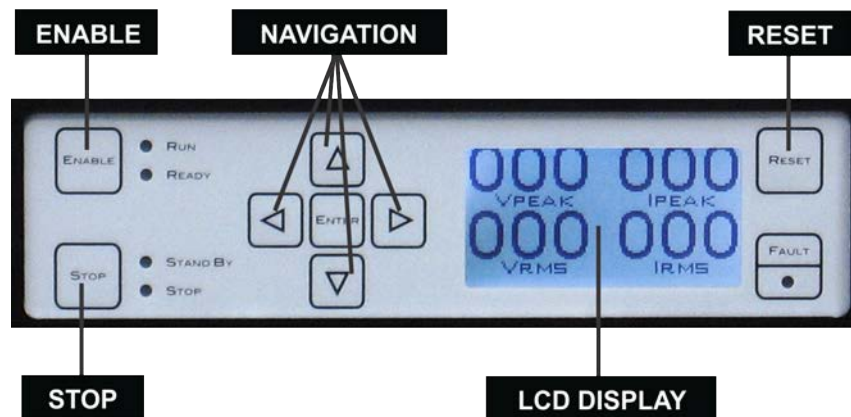

Figure 3.1 – Front Panel Controls and Display

3.1.2 Multi-Function LCD Display

The multi-function LCD display provides various displays of peak and RMS values for voltage and current measured directly from the amplifier output. The amplifier's model name is displayed on the model display screen in the display rotation.

If the amplifier experiences a fault condition, the LCD display will automatically change to display details of the fault condition and prescribed corrective actions.

On startup, the LCD Display will provide readings for all four measurements: Volts peak, Volts RMS, Current peak, and Current RMS. Use the Navigation buttons to scroll to other available displays, such as model name, peak voltage and peak current display, RMS voltage and RMS current display, or other combinations.

3.1.3 Navigation Buttons

The Navigation buttons provide four arrow keys to allow navigation through the different displays on the LCD display screen.

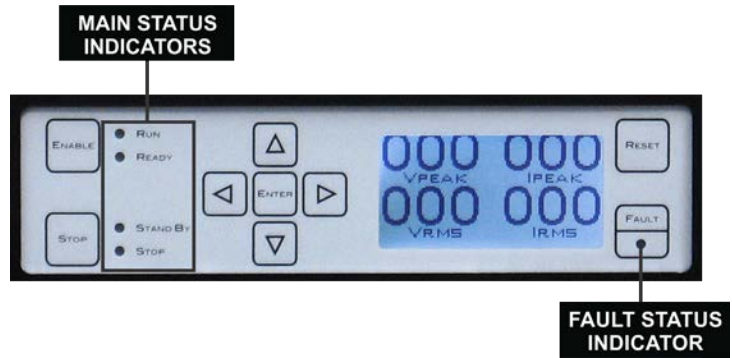

Figure 3.2 – Front Panel Indicators

NOTE: The Enter button has been provided for future expansion and has no function at this time.

3.2 Front-Panel Indicators

This section provides an overview of Front-Panel indicators found on the 7548/7794/7796/7796HC amplifier. Please refer to **Figure 3.2** for item locations.

3.2.1 Main Status Indicators

Four Main Status indicators are located on the amplifier's front-panel. These LEDs monitor the internal conditions of the amplifier and indicate the current state of operation. The chart in **Figure**

Figure 3.3 – Main Status Indicators for Stand-Alone Amplifiers

● ● ● Indicator is lit ● Indicator is not lit ○ Indicator may be lit

Main Status Indicators	State of Operation	Action Needed to Return to Run Mode
<ul style="list-style-type: none"> ● Run ● Ready ● Standby ● Stop 	<p>Run mode: The amplifier's high-voltage transformers are energized and the unit will amplify the input signal. Run mode is initiated by: (1) the Enable push button, or (2) when the amplifier powers up in Run mode (factory default). See the "Advanced Configuration" section for more information.</p>	N/A
<ul style="list-style-type: none"> ● Run ● Ready ● Standby ● Stop 	<p>Standby mode: Standby mode indicates that the amplifier is functioning properly and all Fault Status modes are clear, but it is being held in Standby by an external condition. As configured from the factory (Run mode on startup), the amplifier will enter Standby mode briefly after powering up, and then will move automatically into Run mode. In Standby mode, the amplifier's low-voltage transformer is energized but the high-voltage transformers are not.</p>	<p>If the amplifier remains in Standby mode, it is being held in Standby by remote control through the SIM Interlock I/O connector. Open the Enable/Standby switch to clear this remote Standby condition and return the amplifier to Run mode. See the "Applications" section of this manual for more information on remote amplifier operation.</p>
<ul style="list-style-type: none"> ● Run ● Ready ● Standby ● Stop 	<p>Stop mode: When the Stop button on the amplifier front panel is pressed, the amplifier will enter Stop mode. The amplifier may also enter Stop mode after powering up if the amplifier is configured to enter Stop mode on startup. In Stop mode, the amplifier's low-voltage transformer is energized but the high-voltage transformers are not.</p>	<p>To release the amplifier from Stop mode, press the Enable button.</p>

3.3 details the operational modes indicated by the Main Status indicators.

3.2.2 Fault Status Indicator

The Fault Status indicator is located on the amplifier front panel. This LED monitors the internal conditions of the amplifier and will illuminate when

a fault condition occurs. Depending on the fault condition and the configuration of the unit, the amplifier may be placed in Standby mode when a fault condition occurs. Refer to the chart in **Figure 3.4** to determine the fault condition being indicated and the action required to clear the fault condition.

Figure 3.4 – Fault Status Indicators for Stand-Alone Amplifiers

● ● ● Indicator is lit ● Indicator is not lit ○ Indicator may be lit

Main Status Indicators	Fault Status Reported on LCD Display	State of Operation	Action Needed to Clear Fault Condition and Return to Run Mode
<ul style="list-style-type: none"> ● Run ● Ready ● Standby ● Stop 	WARNING! OUTPUT DEVICE FAULT	Output Device Fault: This indicates that an Output Fault condition has occurred and the amplifier has been placed in Standby mode. The Fault indicator will light under two conditions: 1) High-frequency oscillation is causing high shoot-through current; or 2) An output transistor has shorted, causing the output fault condition.	This fault condition cannot be cleared using the front-panel Reset button. See the Troubleshooting section for more information on diagnosing and clearing this fault condition.
<ul style="list-style-type: none"> ● Run ● Ready ○ Standby ● Stop 	WARNING! OVERLOAD	Overload: This indicates that the output of the amplifier could not follow the input signal due to voltage or current limits. Under normal operation with the factory-default settings, an Overload condition will not place the amplifier in Standby mode. If the amplifier has been configured to be forced to Standby on Overload, the amplifier will be placed in Standby mode when the Overload condition occurs.	To remedy the Overload fault during operation, turn down the level of the input signal until the Fault indicator turns off. To clear an Overload fault condition when the amplifier is forced to Standby, turn down the level of the input signal, then push the Reset button.
<ul style="list-style-type: none"> ● Run ● Ready ● Standby ● Stop 	WARNING! OVERTEMP	Overtemp: The amplifier monitors the temperature inside the high-voltage transformers, low-voltage transformer and in the output stage heat sinks. The Fault indicator will light and the amplifier will be placed in Standby mode when the temperature sensors detect a condition that would damage the amplifier. If the Overtemp pulse is extremely short, as in the case of defective wiring or switches, the Fault LED may be lit too briefly to observe.	To reset after an Over Temp fault has occurred, make sure the amplifier fans in all amplifiers are running, and then remove the input signal from the system. Allow the fans to run for about 5 minutes until the system automatically returns to Run mode. Please see the “ Troubleshooting ” section for information on correcting the cause of an Over Temp fault condition.
<ul style="list-style-type: none"> ● Run ● Ready ● Standby ● Stop 	WARNING! OVERVOLTAGE	Overvoltage: This indicates that the AC mains voltage is more than +10% of nominal. The amplifier will be forced to Standby when an Overvoltage condition occurs. When the Overvoltage condition is cleared, the amplifier will automatically return to Run mode.	To clear an Overvoltage fault condition, the AC mains must be brought down to the nominal value. If the amplifier does not return to Run mode when the Overvoltage condition has cleared, the amplifier may require servicing. Please see the Troubleshooting section for more information.

3.2.3 Main Status Indicators for Multi-amplifier Systems

The Main Status indicators on each amplifier in a multi-amp system are used to determine the operational status of the amplifier. When evaluated

along with the statuses of other amplifiers in the system, the Main Status indicators can be used to determine the system status and the action required to return the system to Run mode. See **Figure 3.5**.

Figure 3.5 – Main Status Indicators for Multi-Amplifier Systems

● ● ● Indicator is lit ● Indicator is not lit ○ Indicator may be lit

Main Status of One or More Amps in the System	Main Status of Other Amps in the System	State of Operation	Action Needed to Return to Run Mode
● Run ● Ready ● Standby ● Stop	● Run ● Ready ● Standby ● Stop	Run mode: All of the amplifiers in the system are in Run mode. The amplifiers' high-voltage transformers are energized and the system will amplify the input signal.	N/A
● Run ● Ready ● Standby ● Stop	● Run ● Ready ● Standby ● Stop	Remote Standby Condition: All of the amplifiers in the system are being held in Standby mode by an external condition. In Standby mode, the amplifiers' low-voltage transformers are energized but the high-voltage transformers are not.	If the amplifiers remain in Standby mode, the system is being held in Standby by remote control through the SIM Interlock I/O connector. Open the Enable/Standby switch to clear this remote Standby condition and return the system to Run mode. See the Applications section of this manual for more information on remote amplifier operation.
● Run ● Ready ● Standby ● Stop	● Run ● Ready ● Standby ● Stop	System Not Ready: If one or more of the amplifiers has no LEDs lit, the amplifier has no power or has not been turned on, and the other amplifiers in the system will be held in Standby mode. In Standby mode, the amplifier's low-voltage transformer is energized but the high-voltage transformers are not.	Make sure all amplifiers have AC power and have been turned on. When all amplifiers attain Standby status, all amplifiers in the system will simultaneously be placed in Run mode.
● Run ● Ready ● Standby ● Stop	● Run ● Ready ● Standby ● Stop	Stop mode: When the Stop button on any amplifier in the system is pressed, that amplifier will enter Stop mode and all other amplifiers will enter Standby mode. The system may also enter Stop mode after powering up if one or more amplifiers in the system is configured to enter Stop mode on startup. In Stop mode, the amplifier's low-voltage transformer is energized but the high-voltage transformers are not.	To release the system from Stop mode, press the Enable button on the amplifier displaying the Stop mode status.

3.2.4 Fault Status Indicators for Multi-Amp Systems

Four different fault error messages may be displayed on the amplifier's front panel LCD screen when a fault condition occurs. All amplifiers in the

system may be placed in Standby mode when a fault condition occurs, depending on the fault condition and the configuration of the system. Typically, the system can be released from Standby mode by pressing the Reset button on the amplifier dis-

playing the Fault status. Refer to the chart below to determine the fault condition being indicated and the action required to clear the fault condition and return the system to Run mode.

Figure 3.6 – Fault Status Indicators for Multi-Amplifier Systems

● Indicator is lit ● Indicator is lit ● Indicator is lit ● Indicator is not lit ○ Indicator may be lit

One or More Amps in System		Main Status Indicators of Other Amps in System	State of Operation	Action Needed to Clear Fault Condition and Return to Run Mode
Main Status Indicators	Fault Status Reported on LCD Display			
<ul style="list-style-type: none"> ● Run ● Ready ● Standby ● Stop 	<p>WARNING! OUTPUT DE- VICE FAULT</p>	<ul style="list-style-type: none"> ● Run ● Ready ● Standby ● Stop 	<p>Output Device Fault status: This indicates that an Output Fault condition has occurred in the amplifier displaying the Fault status, and the system has been placed in Standby mode. The Fault indicator will light under two conditions: 1) High-frequency oscillation is causing high shoot-through current; or 2) An output transistor has shorted, causing the output fault condition.</p>	<p>This fault condition cannot be cleared using the front-panel Reset button. See the Troubleshooting section for more information on diagnosing and clearing this fault condition.</p>
<ul style="list-style-type: none"> ● Run ● Ready ○ Standby ● Stop 	<p>WARNING! OVERLOAD</p>	<ul style="list-style-type: none"> ● Run ○ Ready ○ Standby ● Stop 	<p>Overload status: This indicates that the output of the system could not follow the input signal due to voltage or current limits. Under normal operation with the factory-default settings, an Overload condition will not place the system in Standby mode. If the system has been configured to be forced to Standby on Overload, the system will be placed in Standby mode when the Fault indicator lights.</p>	<p>To remedy the Overload fault during operation, turn down the level of the input signal until the Overload indicator turns off. To clear an Overload fault condition when the amplifier is forced to Standby, turn down the level of the input signal, then push the Reset button on the amplifier(s) displaying the Overload status.</p>
<ul style="list-style-type: none"> ● Run ● Ready ● Standby ● Stop 	<p>WARNING! OVERTEMP</p>	<ul style="list-style-type: none"> ● Run ● Ready ● Standby ● Stop 	<p>Overtemp status: Each amplifier in the system monitors the temperature inside the high-voltage transformers, low-voltage transformer and in the output stage heat sinks. The Overtemp indicator will light and the system will be placed in Standby mode when the temperature sensors detect a condition that would damage the amplifier system. If the Overtemp pulse is extremely short, as in the case of defective wiring or switches, the Fault LED may be lit too briefly to observe.</p>	<p>To reset after an Overtemp fault has occurred, make sure the amplifier fans in all amplifiers are running, and then remove the input signal from the system. Allow the fans to run for about 5 minutes until the system automatically returns to Run mode. Please see the Troubleshooting section for information on correcting the cause of an Overtemp fault condition.</p>

One or More Amps in System		Main Status Indicators of Other Amps in System	State of Operation	Action Needed to Clear Fault Condition and Return to Run Mode
Main Status Indicators	Fault Status Reported on LCD Display			
<ul style="list-style-type: none"> ● Run ● Ready ● Standby ● Stop 	<p>WARNING!</p> <p>OVERVOLTAGE</p>	<ul style="list-style-type: none"> ● Run ● Ready ● Standby ● Stop 	<p>Overvoltage status: This indicates that the AC mains voltage is more than +10% of nominal. All amplifiers in the system will be forced to Standby when an Overvoltage condition occurs. When the Overvoltage condition is cleared, the system will automatically return to Run mode.</p>	<p>To clear an Overvoltage fault condition, the AC mains must be brought down to the nominal value. If the system does not return to Run mode when the Overvoltage condition has cleared, one or more amplifiers may require servicing. Please see the Troubleshooting section for more information.</p>

3.3 Back-Panel Controls and Connectors

This section provides an overview of Back-Panel controls and connectors found on the 7548/7794/7796/7796HC amplifier. Please refer to **Figure 3.7** for visual locations.

AC Power Connector - This is a NEMA style twist lock, 4 pin (208V) or 5-pin (400V), three-phase connector. See **Section 2.6, “Connecting the AC Supply,”** for terminal connections.

Low-Voltage Fuse - This is a 1A slow blow type 600-volt rated fuse.

AC Mains Switch/Circuit Breaker - This dual function power switch and circuit breaker opens all legs of the AC mains. The rating is 20A (7548) or 30A (7794/7796/7796HC) for 208 volts.

Output Terminal Block - Connect output lines from the load to this 4-terminal block. It accepts up to #4 AWG wire. Drive the load in the Controlled Current mode using the OUTPUT terminal and the SAMPLED COMMON terminal only.

BNC Input Connector - This input option provides a standard unbalanced input.

Input Selector Switch - This switch selects which input connector is active, the BNC or Weco.

Weco Input Connector - This input option provides a balanced input.

Interlock Connector - This 25-pin, D-sub connector is used for interlocking and combining functions in a multi-amp system. It can also be used for remote control and monitoring applications (see the **Applications** section for more information).

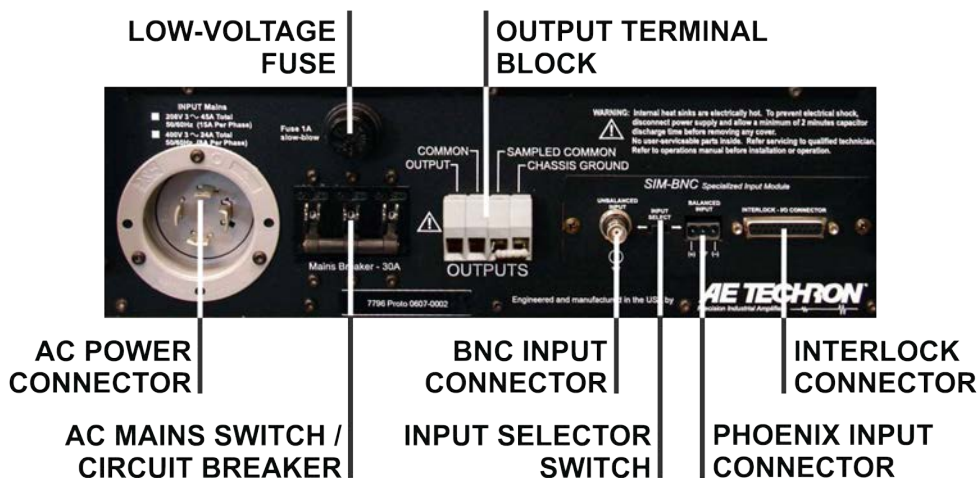

Figure 3.7 – Back Panel Controls and Connectors

4 Advanced Configuration

The 7548/7794/7796/7796HC amplifier was designed to offer exceptional power and versatility in operation. You can choose from a range of field-configurable options, including:

- Operate as a stand-alone amplifier or as part of a multiple-amplifier system.
- Trim the overall gain of the amplifier.
- Select Controlled-Current or Controlled-Voltage modes of operation.
- Adjust the Compensation for Controlled-Current mode of operation.
- Standby Mode/Ready Mode setting for selection of power-up state.
- Stop Mode on Overload setting to trigger Stop Mode when amplifier senses an Overload state.

4.1 Factory Defaults

Your 7548/7794/7796/7796HC amplifier has been configured to operate to the following factory defaults:

- Controlled-Voltage mode
- Master/ Single mode
- CC1 Compensation network
- Power-Up into Ready mode
- Stop Mode on Overload disabled

If you need to make changes to your amplifier's configuration, please follow the instructions contained in this chapter.

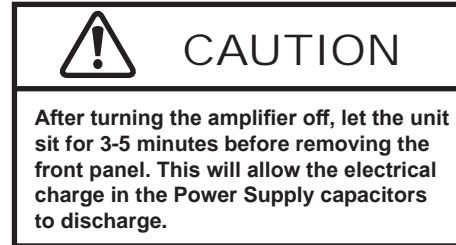

4.2 Accessing the Main Board

The amplifier Main Board can be accessed by removing the amplifier front panel.

IMPORTANT: Before removing the Front Panel, make sure the amplifier is turned off for at least 3-5 minutes and the AC mains are disconnected.

1. Turn the power to the amplifier "OFF".
2. Remove the four hex-head screws, located along the left and right edges of the amplifier front panel using a Torx T15 driver.
3. Remove the front cover by pulling straight towards you.

4.3 Configuration Settings Located on the Main Board

The following custom settings can be made via settings on the Main Board, which is located behind the amplifier front panel.

4.3.1 Master or Follower Setting

The amplifier can be configured for operation within a multi-amplifier system, with up to four amplifiers configured for series or parallel operation. To enable the amplifier for use as a **Follower** amplifier in a multi-amplifier system, adjust the jumper settings on **Jumpers P1** and **P2** by placing **BOTH** jumpers in the **DOWN** position (lower pair of pins). To enable the amplifier for use as a **single amplifier** or as the **Master amplifier** in a multi-amplifier system, adjust the jumper settings on **Jumpers P1** and **P2** by placing **BOTH** jumpers in the **UP** position (upper pair of pins). See **Figure 4.1**.



Figure 4.1 – Master or Follower Setting

For information on input and output wiring and required accessories for multi-amplifier applications, please refer to the **AE Techron Multi-Amp Configuration Guide** available for download from the AE Techron website at www.aetechron.com.

4.3.2 Gain Trim Control

The amplifier allows control of gain via a multi-turn potentiometer (R210). **R232** resistor sets the coarse gain and **R247** sets the range or sensitivity of **R210**. See **Figure 4.2**.



Figure 4.2 – Gain Trim Control

4.3.3 Controlled Voltage or Controlled Current Setting

To allow the amplifier's output voltage to be controlled by its input voltage signal (**CV mode**), place **Jumper J4** in the **RIGHT** position (right pair of pins). To allow the amplifier's output current to be controlled by its input voltage signal (**CC mode**), place **Jumper J4** in the **LEFT** position (left pair of pins). See **Figure 4.3**.

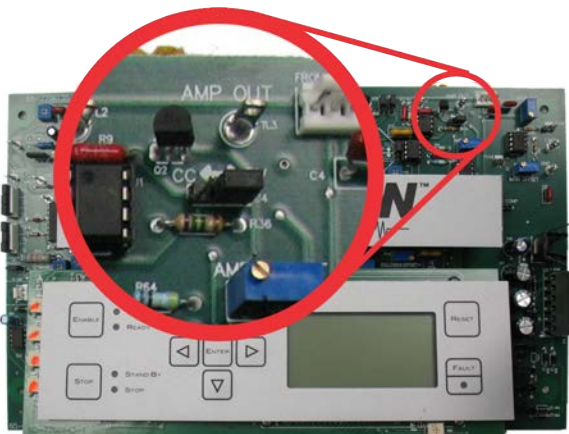

Figure 4.3 – Controlled-Voltage or Controlled-Current Mode Setting



CAUTION

In Controlled-Current Mode, the load is part of the amplifier circuit, and the relationship of the load to the amplifier is critical. For proper and safe operation in Controlled-Current mode, you must observe the following guidelines:

1. **Properly attach a load before operating the amplifier.** Use only the Output and Sampled Common terminals. DO NOT use the Common terminal.
2. **DO NOT use a blocking capacitor.** The load must have a DC path.
3. **Never leave the load open.** If you feel the load must be fused, which could lead to a potential open circuit, please contact AE Techron Application Engineering department.
4. **Check to make sure the load has some inductive component.**
5. **Provide appropriate Compensation for the load.**
6. **Turn off the amplifier immediately if oscillation occurs.**

Failure to follow these guidelines may result **in damage to the amplifier or load.**

4.3.4 Compensation Setting (applies to Controlled Current operation only)

When the amplifier is used in Controlled Current (CC) mode, the current control loop is tuned with one of two available RC networks: CC1 (R63 and C16) or CC2 (R82 and C25). Place **Jumper J5** in the **UP** position to select the **CC1** network (factory default). Place **Jumper J5** in the **DOWN** position to select the **CC2** network. See **Figure 4.4**.

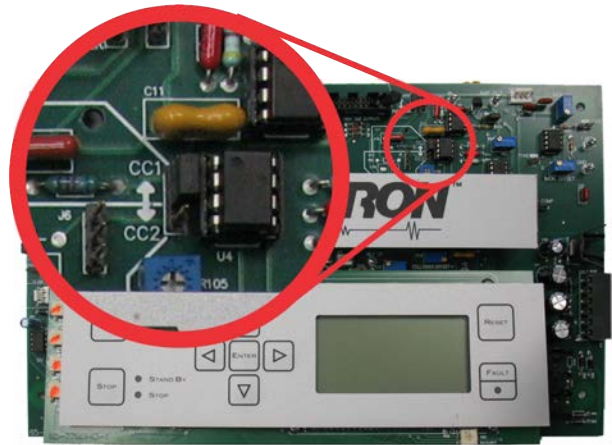

Figure 4.4 – Compensation Setting

4.3.5 Ready/Run Mode or Standby Mode Power-up

The amplifier will bypass Standby Mode and cycle directly to Ready/Run Mode on power-up when **Jumper J11** is in the **Left** position (factory default). To set the amplifier to power-up to Standby Mode, place **Jumper J11** in the **Right** position. See **Figure 4.5**.

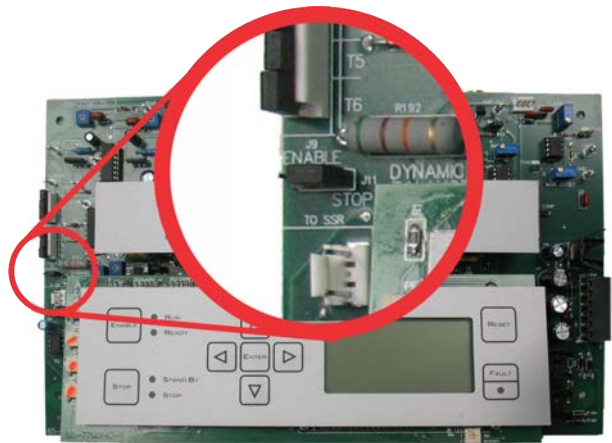

Figure 4.5 – Ready/Run Mode or Standby Mode on Power-Up Setting

4.3.6 Standby Mode on Overload

When this option is enabled, the amplifier will move into Standby Mode when it senses an activation of the IOC (Input/Output Comparator) Distortion Alert circuit. The IOC Distortion Alert circuit continuously compares the input waveform to the output waveform. When a distortion of more than 0.5% occurs, the IOC circuit will activate. The amplifier will remain in Standby Mode until the Reset switch on the front panel is pushed or a Reset signal is received on the Interlock – I/O Connector. Once reset, the amplifier will return to Ready/Run (operational) Mode. To enable Standby Mode on Overload, place the jumper across the **two pins** labeled **J13**. See **Figure 4.6**.

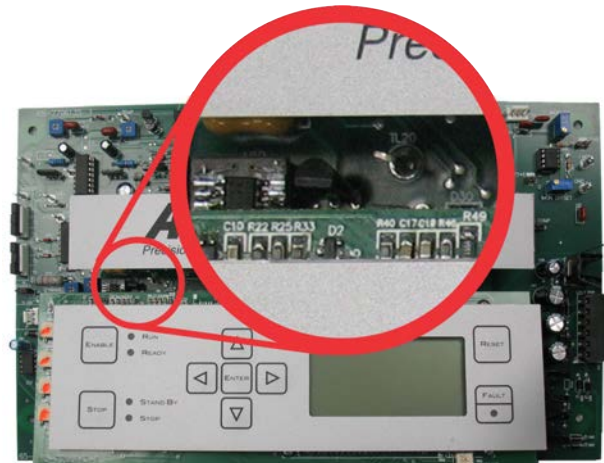

Figure 4.6 – Standby Mode on Overload Setting

4.4 Adjusting the Bi-Level Power Supply Switch

The amplifier offers three Bi-Level switch settings: Automatic, High, or Low. The user can select between settings via a switch on the Power Supply Board. The Power Supply Board is a horizontal board located below the main and display boards. To access the Bi-Level Power Supply Switch, complete the following steps to remove the front panel and access the bi-level power supply switch.

IMPORTANT: Before removing the Front Panel, make sure the amplifier is turned off for at least 3-5 minutes and the AC mains are disconnected.

1. Turn the power to the amplifier "OFF".
2. Remove the four hex-head screws, located along the left and right edges of the amplifier front panel using a Torx T15 driver.
3. Remove the front cover by pulling straight towards you.
4. Locate the Bi-level Power Supply Switch as shown in **Figure 4.7**.

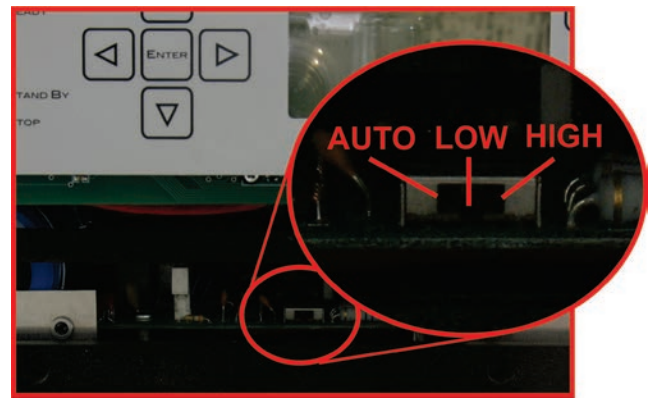

Figure 4.7 – Bi-Level Power Switch Location

5. Adjust the switch setting based on your operating requirements, as described below:

- **AUTO** (left position) – power supply will switch depending on voltage requirements (factory-default setting).
- **LOCKED LOW** (center position) – power supply will remain in low-voltage mode.
- **LOCKED HIGH** (right position) – power supply will remain in high-voltage mode.

5 Applications

5.1 Remote Status and Control using the SIM Interlock I/O Connector

The procedures outlined in this section assume competence on the part of the reader in terms of amplifier systems, electronic components, and good electronic safety and working practices.

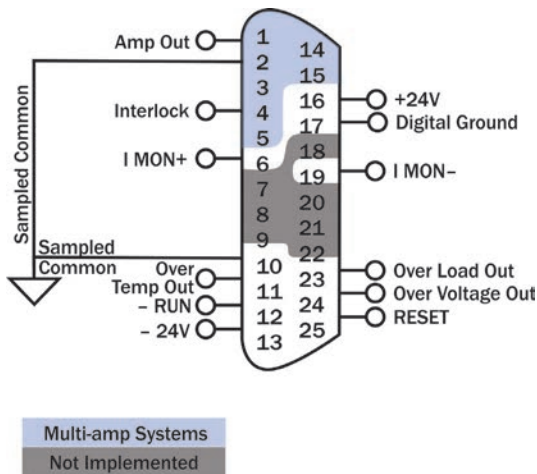

Figure 5.1 – Remote Status and Control Pinouts

AE Techron 7548, 7794, 7796 and 7796HC amplifiers come with a SIM-BNC input module that also contains a female, 25-pin D-Sub connector. This connector can be used to provide remote control and monitoring of the amplifier.

The information provided here will instruct you in the wiring of several control and status applications including:

- Remote Run / Standby
- Over-temperature status
- Run status
- Overload status
- Overvoltage status
- Reset after an Overload error
- Voltage monitor
- Scaled current monitor

Figure 5.1 maps the pins used for these applications.

For a detailed chart of all DB-25 pinouts, see “Appendix 1.”

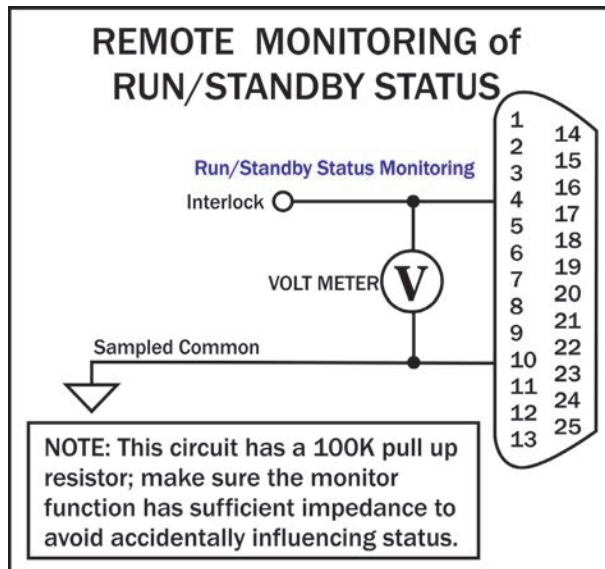

Figure 5.2 – Remote Run/Standby Monitor

5.1.1 Remote Run/Standby Status Monitor

Using the SIM-BNC Interlock connector located on the back panel of the amplifier, you can remotely monitor the Run/Standby status of the amplifier.

Remote Run/Standby Status

Purpose: Use a voltage meter to monitor the status of the amplifier to determine if the amplifier is in a “Run” or “Standby” state.

Method: Connect a voltage meter to monitor the circuit voltage. Connect across PIN 4 (Interlock) and PIN 10 (Sampled Common).

When the voltage meter reads greater than 10V, the amplifier is in the Run state; when the meter reads less than 10V, the amplifier is in the Standby state. See **Figure 5.2**.

Signal Type: DC

Level when Asserted: >10 V

Level when Deasserted: <10 V

IMPORTANT: This circuit has a 100K pull-up resistor. Make sure the monitor function has sufficient impedance to avoid accidentally influencing status.

5.1.2 Remote Amplifier Status and Reset

The SIM Interlock I/O Connector can be used to create a circuit to monitor remotely one or more amplifier conditions, including Run status, Over-temperature, Overload and Overvoltage. The circuit can also be constructed to allow remote reset of the amplifier when it is forced to Standby due to Overload conditions.

Use a male, 25-pin D-Sub connector and high-quality wire to build the circuit. **Figure 5.3** schematic details the circuit and components required for all status and reset functions.

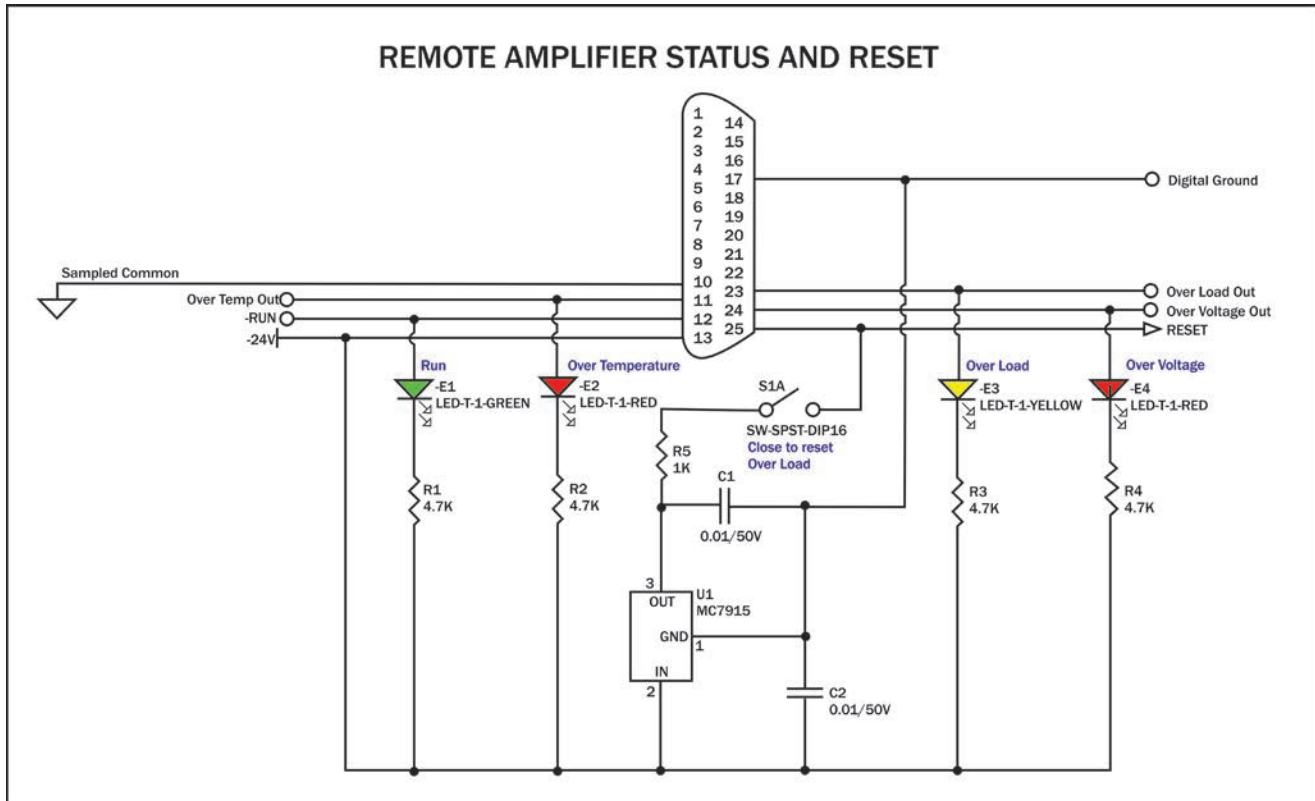

Figure 5.3 – Remote Status and Reset Schematic

Remote Signal of Over Temperature Condition

Purpose: LED, when lit, signals Over Temperature condition.

Method: Use a 6mA series resistor of 4.02 Kohm for LED or OPTO, tie OverTemp Out (PIN 11) to -24V source (PIN 13).

Signal Type: DC

Level when Asserted: -24V

Level when Deasserted: 0V

Note: When amp is normal, this pin is pulled to -24V through a 47.5K-ohm resistor; when amp is in Overtemp state, transistor Q37 turns on and sources chassis ground as an output. Do not exceed 20 milliamps.

An Overtemp condition will force the amp to Standby. The amplifier will automatically move to Run when temperature cools to operating levels.

Remote Signal of Run Condition

Purpose: LED, when lit, signals Run state.

Method: Use a 6mA series resistor of 4.02K-ohm for LED or OPTO, tie Run (PIN 12) to –24V source (PIN 13).

Signal Type: DC

Level when Asserted: –24V

Level when Deasserted: 0V

Remote Signal of Overload Condition

Purpose: LED, when lit, signals Overload condition.

Method: Use a 6mA series resistor of 4.02K-ohm for LED or OPTO, tie OverLoad Out (PIN 23) to –24V source (PIN 13).

Signal Type: DC

Level when Asserted: –24V

Level when Deasserted: 0V

Note: When amp is normal, this pin is pulled to –24V through a 47.5K-ohm resistor; when amp is in Overload state, transistor Q36 turns on and sources chassis ground as an output. Do not exceed 20 milliamps.

An Overload condition will not place the amplifier in Standby when operating with the factory default settings. In order to clear the fault condition, reduce the input levels until the Fault LED turns off. However, if the Standby Mode on Overload option is set, an Overload condition will force amp to Standby. To return the amplifier to Run mode, reduce the input signal level, then trigger a Reset command using the front-panel Reset button or a remote amplifier Reset command.

Remote Signal of OverVoltage Condition

Purpose: LED, when lit, signals Overvoltage condition.

Method: Use a 6mA series resistor of 4.02K-ohm for LED or OPTO, tie OverVoltage Out (PIN 24) to –24V source (PIN 13).

Signal Type: DC

Level when Asserted: –24V

Level when Deasserted: 0V

Note: When amp is normal, this pin is pulled to –24V through a 47.5K-ohm resistor; when amp is in Overvoltage state, transistor Q29 turns on and sources chassis ground as an output. Do not exceed 20 milliamps.

Reset from Standby

Purpose: Switch, when thrown, returns amp to Run condition after Overload conditions.

Method: Use a dry-contact switch, voltage regulator (MC7915), and two 0.01/50V capacitors; wire the circuit as shown (above). Assert 15V for at least 100 ms to clear the error condition.

Signal Type: DC

Level when Asserted: –15V

Level when Deasserted: 0V

Note: Tie to PIN 13 (–24V dc) and create a –15V dc source; <2mA required for reset. Connect the –15V dc source to PIN 25 (Reset) through a 1K buffer resistor to reset.

5.1.3 Remote Enable/Standby

Using the SIM-BNC Interlock connector located on the back panel of the amplifier, you can remotely Enable the amplifier and/or place the unit in Standby mode. See **Figure 5.4**.

Remote Enable/Standby

Purpose: Use a switch or optocoupler to remotely disable the amplifier and place it in Standby mode. Also, return the amplifier from Standby mode to the Run condition.

Method: Short PIN 4 of amplifier to Digital Ground (PIN 17) using a dry contact switch or optocoupler. In multi-amp applications, a switch can be used for Parallel systems, but an optocoupler must be used for Series systems. Multiple amplifiers (sharing the same Sampled Common power connections) can be simultaneously forced to Standby by daisy-chaining Interlock (PIN 4) across amps.

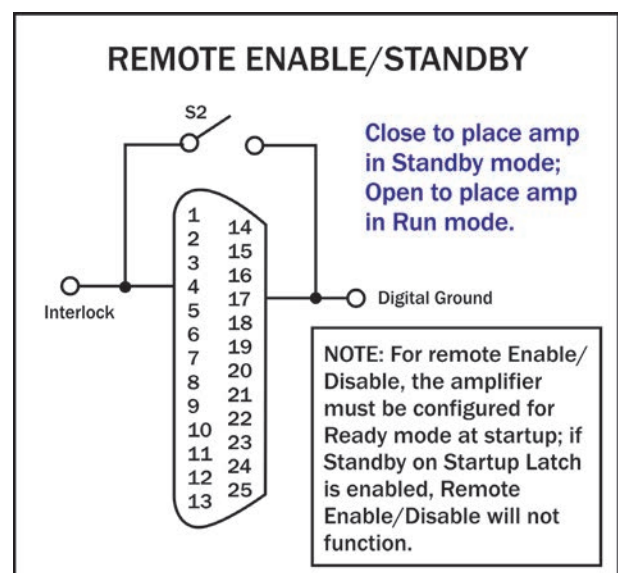

Figure 5.4 – Remote Enable/Standby

When Interlock (PIN 4) is shorted to Digital Ground (PIN 17), the amplifier is placed in Standby mode. When switch is open, the amplifier is released to the Run condition.

Signal Type: DC

Level when Asserted: 0 to 8 V

Level when Deasserted: 10 to 15 V

IMPORTANT: The amplifier must be configured for Ready mode at startup (factory default) or the Run button must be pressed at the amplifier front panel at startup. The Remote Enable/Standby circuit will not function if the Startup to Standby Latch has been activated on the amplifier.

5.1.4 Remote Monitoring of Current

Using the SIM-BNC Interlock connector located on the back panel of the amplifier, you can remotely monitor current output.

Remote Monitoring of Current Output

Purpose: Use a voltage meter to monitor output current.

Method: Connect a voltage meter to monitor the output current being produced by the amplifier. Connect across PIN 6 (I MON+) and PIN 10 (Sampled Common). See **Figure 5.5**.

Signal Type: AC

Level when Asserted: 20A/V

Level when Deasserted: 0V

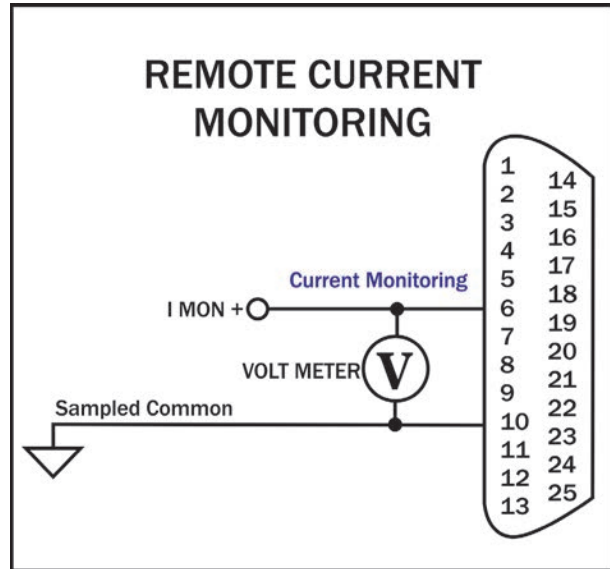

Figure 5.5 – Remote Current Monitoring

Remote Monitoring of Current Output - Alternate Method

Purpose: Use a voltage meter to monitor output current when output is not balanced.

Method: Connect a voltage meter to monitor the output current being produced by the amplifier. Connect across PIN 6 (IMON+) and PIN 19 (IMON-). See **Figure 5.6**.

Signal Type: AC

Level when Asserted: 10A/V

Level when Deasserted: 0V

CAUTION: To avoid ground loops, isolation from ground must be provided. Use of a differential probe is recommended.

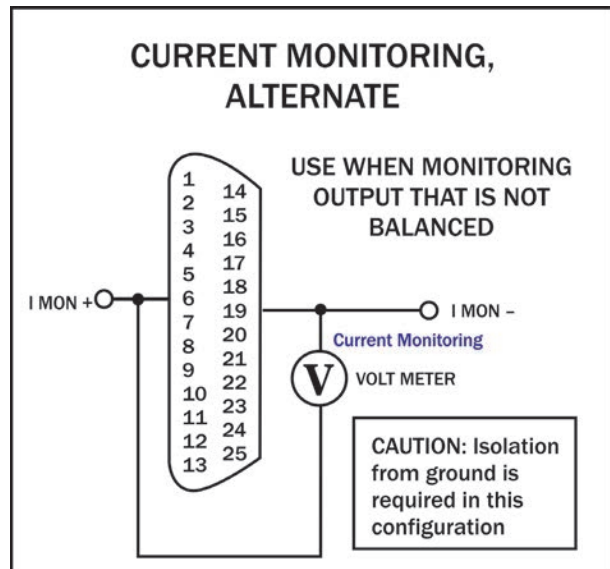

Figure 5.6 – Remote Current Monitoring, Alternate Method

5.2 Controlled Current Operation

The procedures outlined in this section assume competence on the part of the reader in terms of amplifier systems, electronic components, and good electronic safety and working practices.

5.2.1 Controlled-Voltage vs. Controlled-Current Modes of Operation

AE Techron 7548, 7794 and 7796 amplifiers can be field-configured to operate as **Voltage Amplifiers** (Voltage-Controlled Voltage Source) or as **Transconductance Amplifiers** (Voltage-Controlled Current Source). The mode selection is made via a jumper setting located on the amplifier main board. See the **Advanced Configuration** section for more information.

When configured as a **Controlled-Voltage** source (voltage amplifier), the amplifier will provide an output voltage that is constant and proportional to the control (input) voltage. If the load's impedance changes, the amplifier will seek to maintain this ratio of input to output voltage by increasing or decreasing the current it produces, as long as it is within the amplifier's ability to create the required current. Use this mode if you want the output voltage waveform to be like the input waveform (see **Figure 5.7**).

Conversely, when configured as a **Controlled-Current** source (transconductance amplifier), the amplifier will provide an output current that is constant and proportional to the control (input) voltage.

If the load's impedance changes, the amplifier will seek to maintain this transconductance (ratio of input voltage to output current) by increasing or decreasing the voltage it produces, as long as it is within the amplifier's ability to create the required voltage. Use this mode if you want the output current waveform to be like the input waveform (see **Figure 5.8**).

5.2.2 Safety and Operation Considerations for Controlled Current Operation

When an AE Techron amplifier is configured as a Controlled Current source, care needs to be exercised in its operation. **Any voltage controlled current source should never be turned on without a load, (with some impedance, real or effective) connected to its output terminals.**

When asked to operate in this way, any current source (including an AE Techron amplifier) will increase its output voltage in an attempt to drive the requested current into the load. In an open-circuit condition, creating current flow will be impossible. The current source will increase its output voltage until it reaches its voltage limit. This is a potentially dangerous condition for both the AE Techron amplifier and for any user who might come in contact with the amplifier output terminals.

When operating in Controlled Current (CC) mode, a compensation circuit is required to ensure accurate output current. Since the load is a critical circuit component in CC mode, the inductive and

CONTROLLED-VOLTAGE MODE

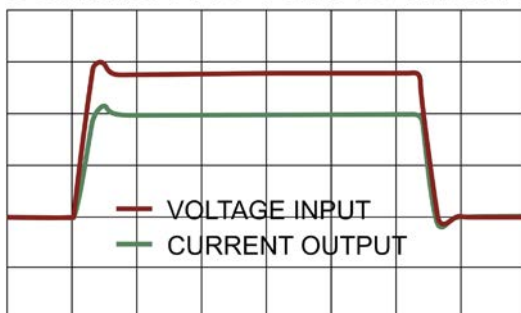

Figure 5.7 – Input to Output Comparison, Controlled-Voltage Operation

CONTROLLED-CURRENT MODE

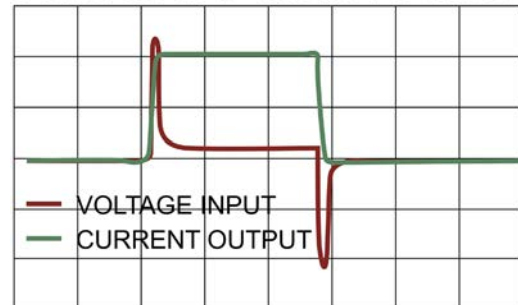

Figure 5.8 – Input to Output Comparison, Controlled-Current Operation

resistive values of the load will determine the required compensation values. While the factory-default compensation setting will be sufficient for some applications, the compensation setting may also be adjusted in the field. The following section describes methods for determining and setting proper compensation when operating in Controlled-Current mode.

5.2.3 Controlling Compensation for CC Operation

AE Techron 7548/7794/7796/7796HC amplifiers can be configured for either Controlled Voltage

(CV) or Controlled Current (CC) mode of operation. When operating the amplifier in Controlled Voltage (CV) mode, compensation is not required. However, when operating in Controlled Current (CC) mode, the amplifier load becomes an integral part of the system. In order to ensure system stability and to control available bandwidth, compensation via an RC network is required for CC operation. The following steps will allow you to compensate your amplifier for operation in CC mode safely and effectively.

STEP 1: Check Amplifier Operation in CV mode.

We recommend that you power-up and enable the amplifier in Controlled Voltage mode without attaching a load before configuring your amplifier for Controlled Current operation. This will allow you to verify that the input signal and the amplifier are operating correctly.

Once this initial check is completed, power down the amplifier and access the amplifier main board to place the amplifier in CC mode. (Refer to the **Advanced Configuration** section for more information.)

One of two compensation settings can be selected via jumpers on the main board: CC1 which en-

ables the factory-installed RC network (see **Figure 5.9**), or CC2 which allows installation of a custom RC network.

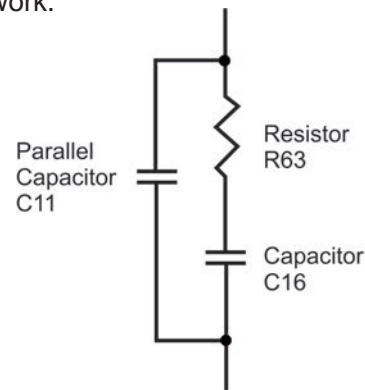

Figure 5.9 – Factory-installed Default RC Network

STEP 2: Determine Required Compensation.

When operating an amplifier in Controlled Current mode, the load becomes an integral part of the system. In order to determine the required compensation for your load, begin by consulting the following table to determine the approximate compensation capacitance (C) required based on the inductance of your load:

NOTE: Load Resistance (R) is assumed to be <5 ohms.

	Load Inductance (L)		
	<200 μ H	<>200 μ H – <1 mH	>1 mH
Compensation Capacitance (CC)	0.001 μ F	0.01 μ F	0.1 μ F

STEP 3: Determine if Default or Custom Compensation is Required.

If your load inductance is between 200 microHenries and 1 milliHenry, and your load resistance is less than 5 ohms, then you can likely use the default compensation provided by the amplifier's factory-installed RC network. To select the factory-default compensation, please see **STEP 4** below.

If your load inductance falls outside of the mid-range, or if your load resistance is greater than 5 ohms, then you must calculate your required compensation. If, after calculating your required compensation, you determine that the default compensation will be insufficient for your load, then you will need to enable and install a custom RC network. See **STEP 6** below.

STEP 4: Enabling Your Compensation Setting.

AE Techron 7000 Series amplifiers can be enabled with one of two compensation settings: default RC network or custom RC network. The required network can be selected via jumpers on the main board. CC1 enables the default (factory-installed) RC network, while CC2 allows installation of a custom RC network. **Figure 5.9** describes the default RC circuit.

To select CC1, place jumper J5 in the UP position; to select CC2, place jumper J5 in the DOWN position. (For jumper location, see the **Advanced Configuration** section.)

IMPORTANT: If CC2 is selected, you must calculate the compensation requirements for your custom RC network and install the network on your amplifier main board before operating the amplifier in CC mode.

STEP 5: (Optional) Verify Suitability of Default Compensation (CC1)

If desired, the following values of the components contained in the default RC network can be used with the formulas provided in **STEP 6** below to verify the suitability of the default compensation for your uses.

Pins Jumped: 1 and 2 (UP)

Compensation Resistor: R63 (68 Kohms)

Compensation Capacitor: C16 (0.047 µF)

Parallel Capacitor: C11 (47 pF)

STEP 6: Installing an RC Network for Custom Compensation

If the default RC network does not provide suitable compensation for your intended load, you will need to install a custom RC network that is matched to your load. This network will require two components (a resistor (R) and a capacitor (C)) to be installed on the main board. To calculate the approximate values required for each component, use the following formulas.

R_c is compensation resistance in ohms.

L is load inductance in henries.

BW is bandwidth in hertz.

To find the value for the capacitor (C_c) in the RC network:

$$C_c = L / (R \times R_c)$$

where:

C_c is compensation capacitance in farads.

L is load inductance in henries.

R is resistance of load in ohms.

R_c is compensation resistance in ohms.

COMPENSATION FORMULAS:

To find the value for the resistor (R_c) in the RC network:

$$R_c = 20,000 \times 3.14 \times L \times BW \text{ where:}$$

STEP 7: Optimizing the Compensation Values.

Once an approximate R_c and C_c have been computed, these values will need to be evaluated. To do this, install components with the required values in the main board at locations R82 and C25 as shown in **Figure 5.10**.

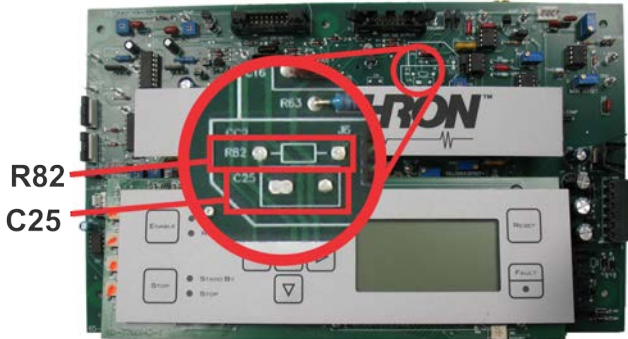

Figure 5.10 – Custom Compensation Location

Remember the load you are connecting is a part of the system and the amplifier should not be turned on without the load being connected.

After installing the components, check to ensure that jumper J5 is correctly installed (see **STEP 4**), then power up the amplifier without signal input.

To begin testing, input a square wave with a frequency of 100 Hz to 1 kHz, or a squared pulse at a low level (typically 0.25 to 2.0 volts). A limited-rise-time, repetitive pulse of low duty cycle is preferred.

Observe the output current through a current monitor or current probe. Look for clean transition edges. The presence of ringing or rounding on the transition edges indicates compensation problems. (See **Figure 5.11**.)

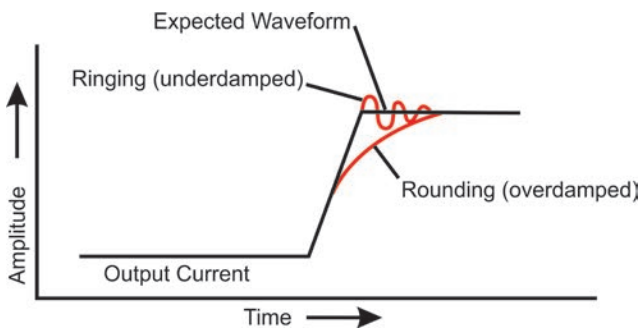
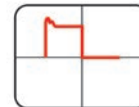

Figure 5.11 – Compensation Effects on Waveform

If a change in compensation is necessary, an adjustment to the resistor component of the Compensation circuit is probably required.

If the output current waveform is ringing, the circuit is underdamped: You have too much gain and should lower the resistance (see **Figure 5.12**).



Decrease R

Figure 5.12 – Square Wave Showing a Decrease in R is Required

If the output current waveform is rounded, the circuit is overdamped: You have too little gain and should increase resistance (see **Figure 5.13**).



Increase R

Figure 5.13 – Square Wave Showing an Increase in R is Required

If the output current waveform is neither underdamped or overdamped, but the top of the square-wave is not level, then you should instead increase the capacitor value (see **Figure 5.14**).

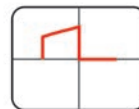

Increase C

Figure 5.14 – Square Wave Showing an Increase in C is Required

When making adjustments:

Resistor: Increase or decrease resistance values in increments of +/- 10%.

Capacitor: Incrementally increase capacitor values by a factor of 2 or 3.

After final adjustments have been made to the circuit, the final waveform for your planned application should be tested to confirm the amplifier's compensation setting.

NOTE:

- If possible, use 1% metal film resistors. AE Techron discourages installation of potentiometers in the resistor location of the compensation

circuit because this can decrease stability and may increase inductance.

- The parallel capacitor in the RC network serves to increase stability but can be removed, if it is not required for system stability. If the parallel capacitor is used, it will usually decrease the value of resistance needed.
- In multiple amplifier systems, expect to decrease the value of R63 in series systems by 1/2.

5.3 Multi-amplifier Systems

The 7548, 7794, 7796 or 7796HC amplifier may be used with other same-model amplifiers to increase voltage or current. Because the internal circuitry of the amplifier is not connected to chassis ground, these amplifiers are well suited for use in series or parallel with other amplifiers of the same model.

Up to three 7548, 7794, 7796 or 7796HC amplifiers may be configured in series, and up to four may be configured in parallel. Configurations with more amplifiers may be possible, depending on the application. Please contact AE Techron **Application Support** for information on these more complex multi-amp systems.

For routine, controlled-voltage applications, Series or Parallel amplifier systems can be configured using the following accessories available from AE Techron:

SIM-OPTOC – The SIM-BNC-OPTOC Specialized Input Module allows multiple 7000-Series amplifiers to be configured as a series output system to increase the available output voltage to the load. The SIM-BNC-OPTOC kit also includes a BNC connector safety cover.

The SIM-BNC-OPTOC module is required for all Series configurations and should be used in conjunction with the DB9M CABLE (see below).

DB9M CABLE – The DB9M (OPTOC) CABLE is a high-voltage Interlock cable that provides superior insulation for multi-amp series systems running high-voltage applications.

The DB9M CABLE is required for all Series configurations and should be used in conjunction with the SIM-BNC-OPTOC module (see above)

BAL RES KIT – Three types available: 7224 BAL RES KIT, 7548 BAL RES KIT and 7794/7796/7796HC BAL RES KIT. Ballast resistors are required for all Parallel configurations. The ballast resistor kits include one ballast resistor (two in the 7794/7796/7796HC kit) with connection terminals and mounting hardware. The 7224 BAL RES KIT also contains the shunt required to defeat the amplifier's external level control.

PARALLEL WIRING KITS – Six types available: 7224/7226 2-AMP, 7548/7794/7796/7796HC 2-AMP, 7224/7226 3-AMP, 7548/7794/7796/7796HC 3-AMP, 7224/7226 4-AMP, and 7548/7794/7796/7796HC 4-AMP. Parallel wiring kits include the DB-25 Interlock cable for system communication, BNC T-connectors and BNC patch cables for wiring parallel inputs through the BNC input connectors, and the output wiring for connecting system amplifiers to the load. The kits also include the wire(s) needed for wiring the parallel inputs through the Removable Barrier Block (WECO) connectors and the .input terminators required during system setup. Parallel wiring kits are recommended for all Parallel configurations.

To download the AE Techron **7000-Series Multi-Amp Configuration Guide** or for additional information, visit the AE Techron website at www.aetechron.com.

6 Maintenance

Simple maintenance can be performed by the user to help keep the equipment operational. The following routine maintenance is designed to prevent problems before they occur. See the **Troubleshooting** section for recommendations for restoring the equipment to operation after an error condition has occurred.

Preventative maintenance is recommended after the first 250 hours of operation, and every three months or 250 hours thereafter. If the equipment environment is dirty or dusty, preventative maintenance should be performed more frequently.

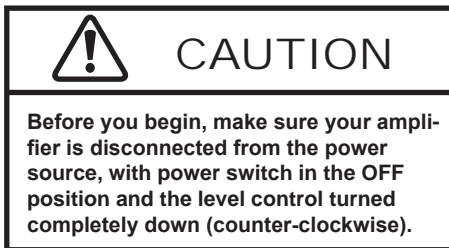

6.1 Clean Amplifier Filter and Grills

6.1.1 Tools Required

The recommended equipment and supplies needed to perform the functions required for this task are described below.

- Torx T15 driver
- Vacuum cleaner
- Damp cloth (use water only or a mild soap diluted in water)

To ensure adequate cooling and maximum efficiency of the internal cooling fans, the amplifier's front and rear grills should be cleaned periodically. To clean the amplifier grills and filter, complete the following steps:

1. Turn the amplifier OFF. Disconnect the amplifier from its power source.
2. Remove the four Torx-head screws, located along the left and right edges of the amplifier's front panel using a Torx T15 driver. Retain.
3. Remove the amplifier's front cover by pulling straight towards you.
4. Using a vacuum cleaner, vacuum the front and rear ventilation grills. Vacuum the filters behind the front ventilation grill.
5. Using a damp cloth, clean the front and rear ventilation grills. Dry with a clean cloth or allow to air dry. **IMPORTANT: Grills should be completely dry before plugging in or restarting amplifier.**

7 Troubleshooting

7.1 Introduction & Precautions

This section provides a set of procedures for identifying and correcting problems with the 7548/7794/7796/7796HC amplifier. Rather than providing an exhaustive and detailed list of troubleshooting specifications, this section aims to provide a set of shortcuts intended to get an inoperative amplifier back in service as quickly as possible.

The procedures outlined in this section are directed toward an experienced electronic technician; it assumes that the technician has knowledge of typical electronic repair and test procedures.

Please be aware that these amplifiers may undergo frequent engineering updates. As a result, modules and electronic assemblies may not be interchangeable between units. Particularly, the Main board undergoes periodic engineering modifications that may make interchangeability between units impossible.

 **DANGER**

Uninsulated terminals with AC Mains potential are exposed when the panel is removed. Do not proceed until AC Mains have been disconnected.

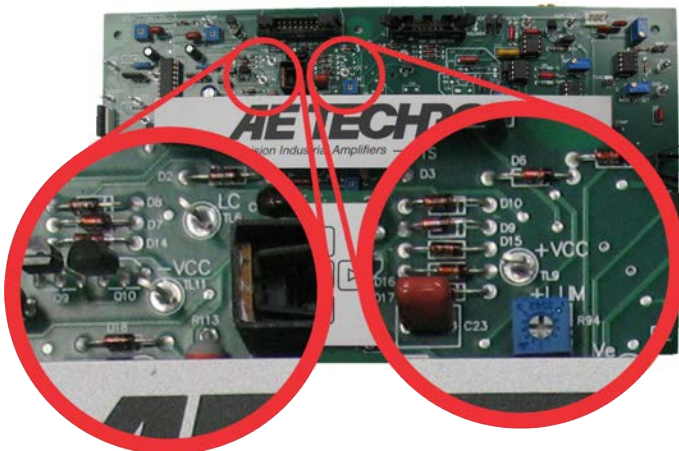

Figure 7.1 – +Vcc and –Vcc Point Locations

7.2 Visual Inspection

Before attempting to troubleshoot the amplifier while it is operating, please take time to complete a visual inspection of the internal components of the amplifier.

1. To perform a Visual Inspection, first turn OFF the power at the rear circuit breaker.
2. Disconnect the AC mains plug from the amplifier.
3. Wait three to five minutes for the Power Supply capacitors to discharge.
4. Remove the 16 single screws from the top cover.
5. You can verify the capacitor discharge by connecting a voltmeter across +Vcc and –Vcc test points on the main board (see **Figure 7.1**). Verify a reading of less than 5 volts before proceeding.
6. Inspect the amplifier's internal components (see **Figure 7.2**). Check the following:
 - Inspect modules for charring, breaks, deformation or other signs of physical damage.
 - Look for any foreign objects lodged inside the unit.
 - Inspect the entire lengths of wires and ribbon cables for breaks or other physical damage.
7. If there is any physical damage to the amplifier, please return it to AE Techron for repair.

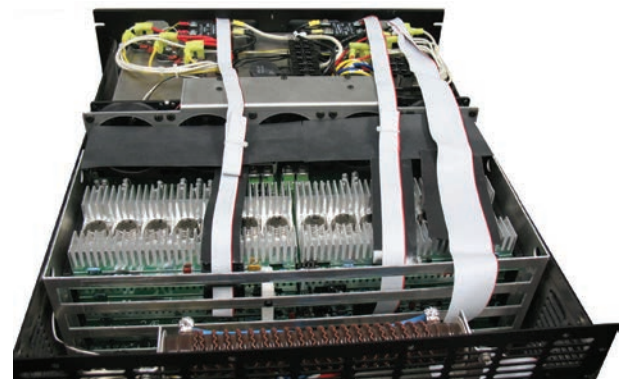

Figure 7.2 – Amplifier cover removed for inspection



Figure 7.3 – Fuse F1 Location

7.3 No Signal

Missing Output signal may be caused by one of the following:

1. Master/Follower Jumpers are set to the Follower (down) position. The amplifier should only be configured for Follower mode if it is in a multi-amplifier system; otherwise it should be set for Master mode. See the **Advanced Configuration** section in this manual for more information.
2. Signal is not connected to any inputs on the SIM card. See the **Amplifier Setup** section in this manual for more information.

7.4 No LEDs Illuminated or No Fans

If none of the LEDs on the Display Panel are illuminated and/or the fans are inoperative, check the following:

1. The AC mains are not connected or not on (see the **Amplifier Setup** section for more information).
2. Back Panel Breaker is not in the UP position.
3. Fuse F1 is open.

To Inspect Fuse F1 follow these steps:

1. Turn Off the amplifier and disconnect the AC mains.
2. Locate Fuse Cover on the amplifier back panel (see **Figure 7.3**). Remove Fuse Cover.
3. Remove fuse and inspect. Replace, if necessary, with 1A slow blow fuse.

7.5 OverVoltage Warning Message

The amplifier will protect itself from AC mains voltage that is 10% above the voltage indicated on the back panel. If the AC mains voltage is more than 10% above the operating voltage, reduce the

AC mains voltage to the proper level. When the line voltage condition is corrected, the amplifier will automatically reset. If the amplifier does not automatically reset, the amplifier's three internal transformers may need to be rewired. Please see the Factory Service information at the end of this section.

7.6 Standby LED Remains Illuminated

The Standby indicator may remain illuminated under three conditions:

1. If the output wells or power transformer have overheated. If overheating is the problem, see the following topic ("**Amplifier Overheats**").
2. If both the Standby and Ready LEDs remain illuminated and the Interlock I/O Cable is being used, the amplifier is being held in Remote Standby mode by another device (see **Figure 7.4**). For more information on Remote Operation, see the **Applications** section in this manual.
3. If the connection to the Interlock – I/O Connector or other input/output connection isn't fully secure. Check all wiring and connections.



Figure 7.4 – Interlock I/O Connector

7.7 Amplifier Overheats (Over Temp Fault Condition)

There are two possible reasons why the amplifier is overheating:

1. Excessive Power Requirements
2. Inadequate Airflow

7.7.1 Excessive Power Requirements

An amplifier will overheat if the required power exceeds the amplifier's capabilities. High duty cycles and low-impedance loads are especially prone to cause overheating. To see if excess power requirements are causing overheating, check the following:

1. The application's power requirements fall within the specifications of the amplifier. See the **Specifications** section.
2. Faulty output connections and load.
3. Undesired DC offset at the Output and Input signal.

7.7.2 Monitoring Heat Sink Temperature

When running the amplifier in very difficult conditions, monitoring the amplifier's heat sink temperatures can be very instructive. The amplifier has convenient points for monitoring heat sink temperatures located on the main circuit board. See **Figure 7.5**.

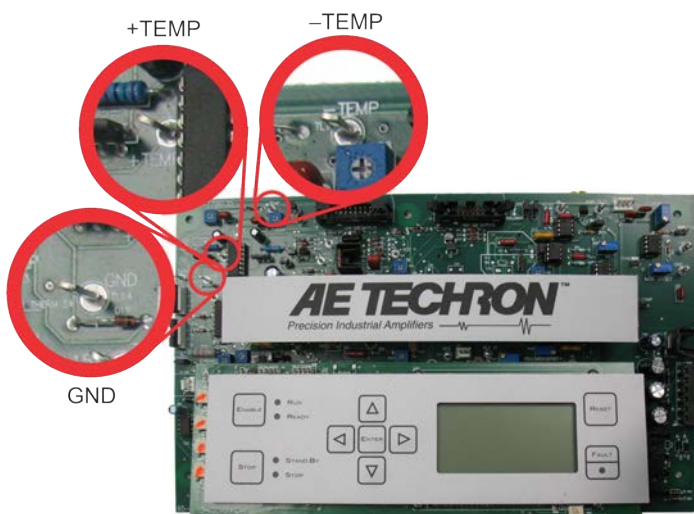

Figure 7.5 – +TEMP and -TEMP test point locations

Connect across +TEMP and GND to monitor the heat sinks responsible for positive voltages; connect across –TEMP and GND to monitor the heat sinks responsible for negative voltages.

When running typical sine-type wave forms, readings at both monitor points should be similar. A deviation can be an indication of a DC offset that is causing one side of the amplifier to work harder than the other.

To convert the monitor point voltage readings to degrees Celsius:

$$\text{Temperature in degrees Celsius} = (V \times 100) - 273$$

Where:

V = Voltage at Pin (ex. 3.73)

V x 100 = Degrees Kelvin (ex. 373.0)

–273 = Degrees Celsius (ex. 100°C)

It is recommended for most applications that long-term amplifier heat sink temperatures be limited to 100-120°C.

7.7.3 Check for Inadequate Airflow

If the amplifier chronically overheats with suitable power/load conditions, then the amplifier may not be receiving adequate airflow. To check for adequate airflow, proceed with the following steps:

1. Check air filters. Over time they can become dirty and worn out. It is a good idea to clean the air filters periodically with a mild detergent and water.
2. Visually inspect fans to assure correct operation while amplifier is On.

Any inoperative, visibly slow, or reverse-spinning fan should be replaced. Please see the Factory Service information at the end of this section.

An OverTemp condition places the amplifier in Standby mode. If the OverTemp pulse is extremely short, as in the case of defective wiring or switches, the OverTemp pulse may be too brief to observe.

7.7.4 Resetting After OverTemp

To reset the amplifier after an OverTemp has occurred, make sure fans are running, then remove the input signal from the amplifier. Allow the fans to run for five minutes, and then push the Reset button to reset the amplifier.

7.8 Fault LED is Illuminated

The 7548/7794/7796/7796HC contains protection circuitry that disables the amplifier if an output stage is behaving abnormally. This usually indicates an output transistor has shorted.

To clear the Fault condition, follow these steps:

1. Turn off the signal source.
2. Turn off the AC mains.
3. Turn AC mains power back on. If the Fault LED doesn't illuminate again, turn the signal source on.
4. If the Fault LED is still illuminated and the Fault condition doesn't clear, return the amplifier for Factory Service. Please see the Factory Service information at the end of this section.

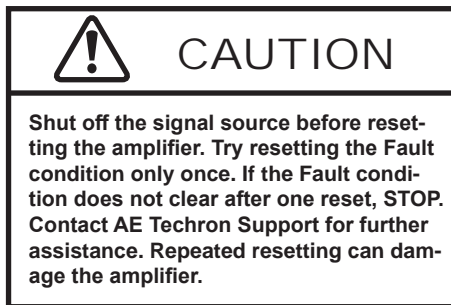

7.9 Factory Service

If the troubleshooting procedures are unsuccessful, the amplifier may need to be returned for Factory Service. All units under warranty will be serviced free of charge (customer is responsible for one-way shipping charges as well as any custom fees, duties, and/or taxes). Please review the Warranty at the beginning of this manual for more information.

All service units must be given Return Authorization by AE Techron, Inc. before being returned. Return Authorizations can be requested on our website or by contacting our Customer Service Department.

Please take extra care when packaging your amplifier for repair. It should be returned in its original packaging or a suitable alternative. Replacement packaging materials can be purchased for a nominal fee.

Please send all service units to the following address and be sure to include your Return Authorization Number on the box.

AE Techron, Inc.
Attn: Service Department / RMA#
2507 Warren Street
Eikhart, IN 46516

8 Specifications

8.1 Performance (Controlled Voltage Mode)

Note: Testing performed at 208V/415V AC. The 7548/7794/7796 amplifiers can operate from 400V AC $\pm 10\%$. Since these amplifiers have an unregulated power supply, low line conditions may slightly affect the maximum voltage potential.

Accuracy was measured when driven into a 10-ohm load with between 0.1VDC and 6VDC or between 0.2V AC and 5V AC presented at its inputs.

Frequency Response: DC - 30 kHz, +0.1 to -0.5 dB

Maximum Continuous Output Power:

7548: 3300 watts RMS

7794: 5000 watts RMS

7796: 5000 watts RMS

7796HC: 2500 watts RMS

Slew Rate: >35 V/ μ s

Phase Response (10 Hz – 10 kHz):

7548: ± 5 degrees

7794, 7796 and 7796HC: ± 8.3 degrees

Unit to Unit Phase Error: ± 0.1 degrees at 60Hz

Output Offset: Less than 200 μ V

Output Offset Current: Less than 10 mA DC

Output Impedance:

3.2 m Ω in Series with 2.2 μ H

DC Drift: ± 400 μ V (from cold to maximum operating temperature); ± 200 μ V (after 20 minutes of operation)

Residual Noise, 10 Hz to 20 kHz: Less than 250 μ V

THD, DC - 20 kHz,

7548, 7794 and 7796HC: >0.25%

7796: >0.2%

Input Characteristics,

Balanced with ground: Three-terminal barrier-block connector, 20 k Ω differential

Unbalanced: BNC connector, 10 k Ω single ended

Gain:

Voltage Mode: 20 volts/volt

Current Mode: 20 amperes/volt

Gain Linearity (over input signal, from 0.2V to 5V),

DC: 0.0125%

AC: 0.030%

Max Input Voltage: ± 10 V balanced or unbalanced

Input Impedance: 20 k Ω differential

Input Sensitivity:

3.0V input for 3800W output into 1 ohm (adjustable)

Common Mode Rejection Range:

± 11 VDC maximum

Common Mode Rejection Ratio,

7548: Better than -65 dB

7794, 7796, 7796HC: Better than -70 dB

8.2 Display, Control, Status, I/O

Front Panel

LED Displays Indicate: Run, Ready, Standby, Stop, and Fault conditions in the output stage

LCD Display: Lists type of fault condition and gives suggested corrective action

Soft-Touch Switches for: Run (Enable), Stop, Reset

LCD Display: Can be configured for up to four simultaneous displays reporting one, two, or all four of the following: V_p , V_{RMS} , A_p , A_{RMS} . Also reports any fault conditions that occur and suggests corrective action.

Back Panel

Power Connection: NEMA-style locking receptacle; matching AC connector also included

Signal Output: 4-position terminal barrier block (OUTPUT/Common/SAMPLED Common/CHASSIS GROUND); resistor installed between SAMPLED Common and CHASSIS GROUND is a 2.7-ohm, 2W, 5%, metal-oxide resistor

Signal Input: User-selectable Unbalanced BNC or Balanced Barrier Strip

Interlock Connector: 25-pin D-sub connector used for amplifier control and status applications; also used in multi-amplifier applications

8.3 Communication Capabilities

Current Monitor: ± 1 V / 20A $\pm 1\%$

Reporting: System Fault, OverTemp, Over Voltage, Overload

Control: Force to Standby; Reset after a fault

8.4 Protection

Over/Under Voltage: $\pm 10\%$ from specified supply voltage amplifier is forced to Standby

Over Current: Breaker protection on both main power and low voltage supplies

Over Temperature: Separate Output transistor, heat sink, and transformer temperature monitoring and protection

8.5 Physical Characteristics

Chassis: Black powder-coat chassis with all aluminum construction; designed for stand-alone or rack-mounted operation. The amplifier occupies five (7548) or seven (7796) EIA 19-inch-wide rack units.

Weight:

7548: 103 lbs (46 kg), Typical shipping:

115 lbs (52.2 kg)

7794, 7796 and 7796HC: 153 lbs (69 kg),

Typical shipping: 168 lbs (76.2 kg)

AC Power: A toggle switch circuit breaker opens all legs of the AC mains on excess current demand.

7548: Three-phase, 208V AC ($\pm 10\%$), 47-60 Hz, 20A AC service (400V AC ($\pm 10\%$), 15A version available).

7794 and 7796: Three-phase, 208V AC ($\pm 10\%$), 47-60 Hz, 30A AC service (400V AC ($\pm 10\%$), 15A version available).

7796HC: Three-phase, 208V AC ($\pm 10\%$), 47-60 Hz, 30A AC service (400V AC version NOT available).

Operating Temperature: 10°C to 50°C (50°F to 122°F), Maximum Output Power de-rated above 30°C (86°F)

Humidity: 70% or less, non-condensing

Cooling: Forced air-cooling from front to back through removable filters via four (7548) or six (7794/7796/7796HC) 100 ft³/min. fans. No space is required between rack-mounted amplifiers. Air filters are removable from the rear via one fastener per side and may be eliminated if cabinet filtration is provided.

Dimensions:

7548: 19" x 22.8" x 8.75" (48.3 cm x 57.9 cm x 22.2 cm). Unit occupies 5 - EIA 19-inch wide rack units.

7794, 7796 and 7796HC: 19" x 22.8" x 12.25" (48.3 cm x 57.9 cm x 31.1 cm). Unit occupies 7 - EIA 19-inch wide rack units.

Appendix A: SIM - Interlock I/O Connector Pinouts and Functions

Pin #	Function	Description	Signal Type	Level when Asserted	Level when Deasserted	Notes	Applications
1	Amplifier Output	Used for driving Follower amplifiers; monitoring amplifier output voltage	AC or DC	Can be greater than $\pm 200V$ peak	0V	Used for monitoring amplifier output voltage; driving Follower amplifiers in multi-amp systems. Wired to amplifier output. Do not connect to any impedance of less than 10K ohm.	Voltage Monitoring: Connect a voltage meter to monitor the output voltage being produced by the amplifier. Connect across PIN 1 (Amp Out) and PIN 10 (Sampled Common).
2	Sampled Common	Load connected here for Current sense	AC or DC	Up to $\pm 2V$ peak relative to Common	0V	Used for driving Follower amplifiers in multi-amp systems, controlled voltage or controlled current mode.	Driving Follower Amplifiers: Amplifier External Reference, 2V peak maximum from PIN 14 (Common).
3	+1 IN	Differential Follower input	AC or DC	Can be greater than $\pm 200V$ peak	0V	Only used in multiple amplifier configurations - Series mode.	Can accept output of PIN 1 (Amplifier Output) OR PIN 2 (Sampled Common) from Master device when in Follower mode.
4	Interlock	Amplifier Interlock input	DC	0V to 8V	10V to 15V	When "low", forces to Standby; when allowed to float, allows Run (if amplifier is "Ready"). IMPORTANT: amplifiers must be configured for Run mode at startup (factory default) or the Run button must be pressed at the amplifier front panel at startup.	Remote to Standby: Short PIN 4 of amplifier to Digital Ground (PIN 17) using dry contact switch or optocoupler. When closed, places amplifier in Standby. Multi-amplifier Systems, Simultaneous Enable or Disable of amplifiers: Daisy-chain Interlock (PIN4) across amps (if sharing the same Sampled Common power connections). Optocoupler must be used for multi-amps in series.
5	Amp Ready	Ready output of amplifier	DC	0V	-14V	Normally reserved for OPTOC use; not recommended for normal customer use. Line has series resistor and unloaded will go from 0V (not ready) to -15V (ready), with an OPTOC BNC card the signal will go from 0V (not ready) to -1.2Vdc (ready)	Not recommended for normal customer use.
6	I MON +	Differential Current Monitor +	AC or DC	7212/7224/7226: 5A/V 7548/7794/7796/7796HC: 20A/V		Output current produced per voltage detect.	Current Monitoring: Connect a voltage meter to monitor the output current being produced by the amplifier. For unbalanced, for each 1V detected, current output is 5A (7212/7224/7226) or 20A (7548/7794/7796/7796HC).
7	None	No connection					Not currently used.
8	None	No connection					Not currently used.
9	Blanking input	Blanking control	DC	0 - 1Vdc allows normal operation	3.5 - 5Vdc output is muted	Used in amplifiers with blanking feature included for blanking control.	Blanking Control: Use an external isolated 5V power supply to mute the output of the amplifier.

Pin #	Function	Description	Signal Type	Level when Asserted	Level when Deasserted	Notes	Applications
10	Sampled Common	Amp Analog Ground; Blanking Ground				Amplifier ground.	Can be used as Blanking return or as a reference of the amplifier for status reporting applications. See OverTemp (PIN 11), Run (PIN 12), Overload (PIN 23), and OverVoltage (PIN 24).
11	OverTemp Out	Over-temperature output	DC	-24V	0V	When amp is normal, this pin is pulled to -24V through a 47.5K-ohm resistor; when amp is in OverTemp state, this pin is grounded. Do not exceed 7 milliamps.	Remote Signal of Over-Temperature Condition: LED, when lit, signals Over Temperature condition. Use a 6 mA series resistor of 4.7K-ohm for LED or OPTO, tie to -24V source (PIN 13).
12	Run	Amplifier Run output	DC	-24V	0V	When amp is in Standby mode, this pin is pulled to -24V; when amp is in Run mode, this pin is grounded, energizing Mains Relays and allowing drive for an external LED. DO NOT exceed 7mA; DO NOT ground this pin as this will enable Main Power Relays.	Remote Signal of Run Condition: LED, when lit, signals Run state. Use a 6mA series resistor of 4.7K-ohm for LED or OPTO, tie to -24V source (PIN 13).
13	-24V	-24V Power Output	DC			-24V dc, 30 mA max	Internally tied for use in status reporting applications. See OverTemp (PIN 11), Run (PIN 12), Overload (PIN 23), and OverVoltage (PIN 24).
14	Common	Ground before Sense Resistors				Current monitor reference. Voltage between Common and Sampled Common is voltage on the Current Sense resistor.	Possibly series amplifiers will not need current reporting on the High side amp, since its current will be same as Master.
15	-1 IN	Differential Follower Input	AC or DC	Up to 200V peak	0V	Only used in multiple amplifier configurations, Series mode.	Can accept output of PIN 1 (Amplifier Output) OR PIN 2 (Sampled Common) from Master device when in Follower mode.
16	+24V	+24V Power Output	DC			+24V dc, 30 mA max.	Used in status reporting applications. See OverTemp (PIN 11), Run (PIN 12), Overload (PIN 23), and OverVoltage (PIN 24).
17	Digital Ground	Digital circuitry ground - Interlock Common	DC	0V	0V		Used with PIN 25 (Reset) for Remote Reset from Standby or Stop after Error. Used with PIN 4 (Interlock) for simultaneous remote to Standby of all amps in a multi-amplifier system.
18	OEM App	Input Monitor (OEM only)				Used to monitor the input signal from an OEM DAC card; this is the actual input signal.	OEM modification only; normally no connection.
19	I MON - (alt.: OEM App)	Differential Current Monitor - ; (- Input Monitor, OEM only)	AC or DC	7212/7224/7226: 5A/V 7548/7794/7796/7796HC: 20A/V		Inverted I MON+ (PIN 6). Output current produced per voltage detect.	Current Monitoring: Connect a voltage meter to monitor the output current being produced by the amplifier. For each 1V detected, current output is 5A (7212/7224/7226) or 20A (7548/7794/7796/7796HC).

Pin #	Function	Description	Signal Type	Level when Asserted	Level when Deasserted	Notes	Applications
20	I SUM1-	Multiple Amplifier Summing, Amplifier 1	DC			Planned for use in multiple amplifier configurations - paralleled and running Controlled Current Mode	Currently not used.
21	I SUM2-	Multiple Amplifier Summing, Amplifier 2	DC			Planned for use in multiple amplifier configurations - paralleled and running Controlled Current Mode	Currently not used.
22	I SUM3-	Multiple Amplifier Summing, Amplifier 3	DC			Planned for use in multiple amplifier configurations - paralleled and running Controlled Current Mode	Currently not used.
23	OverLoad Out	Overload output (amplifier output is clipping).	DC	-24V	0V	When amp is normal, this pin is pulled to -24V through a 47.5K-ohm resistor; when amp is in Overload state, this pin is grounded. Do not exceed 6 milliamps.	Remote Signal of Overload Condition: LED, when lit, signals Overload condition. Use a 6mA series resistor of 4.7K-ohm for LED or OPTO, tie to -24V source (PIN 13).
24	OverVoltage Out	Overvoltage output (High AC line voltage).	DC	-24V	0V	When amp is normal, this pin is pulled to -24V through a 47.5K-ohm resistor; when amp is in Overvoltage state, this pin is grounded. Do not exceed 6 milliamps.	Remote Signal of Overvoltage Condition: LED, when lit, signals Overvoltage condition. Use a 6mA series resistor of 4.7K-ohm for LED or OPTO, tie to -24V source (PIN 13).
25	Reset	Reset	DC	-15V	0V	Tie to PIN 13 (-24V dc) and create a -15V dc source; <2mA required for reset. Connect the -15V dc source to PIN 25 (Reset) through a 1K buffer resistor to reset.	Reset from Standby: Use a dry contact switch and voltage regulator to return amp to Ready/Run condition after Overload conditions. Assert -15V for at least 100 ms to clear error condition.
Gray shaded areas indicate pin not used / feature not implemented.						Blue shaded areas indicate used only in multi-amplifier systems.	