



Advanced Test Equipment Rentals
www.atecorp.com 800-404-ATEC (2832)



Agilent Technologies

8498A
Fixed Attenuator

Operating and Service
Manual

The contents of this manual apply to instruments with serial number prefix US91 and above.

Agilent Part Number: 08498-90008
Printed in USA
Print Date: April 2001
Supersedes: February 1999

Notice

The information contained in this document is subject to change without notice.

Agilent Technologies makes no warranty of any kind with regard to this material, including, but not limited to, the implied warranties of merchantability and fitness for a particular purpose. Agilent Technologies shall not be liable for errors contained herein or for incidental or consequential damages in connection with the furnishing, performance, or use of this material.

Agilent Technologies assumes no responsibility for the use or reliability of its software on equipment that is not furnished by Agilent Technologies.

This document contains proprietary information which is protected by copyright. All rights are reserved. No part of this document may be photocopied, reproduced, or translated to another language without prior written consent of Agilent Technologies.

Restricted Rights Legend

Use, duplication, or disclosure by the U.S. Government is subject to restrictions as set forth in subparagraph (c)(1)(ii) of the Rights in Technical Data and Computer Software clause at DFARS 252.227-7013 for DOD agencies, and subparagraphs (c)(1) and (c)(2) of the Commercial Computer Software Restricted Rights clause at FAR 52.227-19 for other agencies.

Agilent Technologies, Inc
Santa Rosa Systems Division
1400 Fountaingrove Parkway
Santa Rosa, CA 95403-1799, U.S.A.

Warranty

Certification

Agilent Technologies certifies that this product met its published specifications at the time of shipment from the factory. Agilent Technologies further certifies that its calibration measurements are traceable to the United States National Institute of Standards and Technology (NIST, formerly NBS), to the extent allowed by the Institute's calibration facility, and to the calibration facilities of other International Standards Organization members.

Warranty

This Agilent Technologies system product is warranted against defects in materials and workmanship for a period corresponding to the individual warranty periods of its component products. Instruments are warranted for a period of one year. During the warranty period, Agilent Technologies will, at its option, either repair or replace products that prove to be defective.

Warranty service for products installed by Agilent Technologies and certain other products designated by Agilent Technologies will be performed at Buyer's facility at no charge within Agilent Technologies service travel areas. Outside Agilent Technologies service travel areas, warranty service will be performed at Buyer's facility only upon Agilent Technologies's prior agreement and Buyer shall pay Agilent Technologies's round trip travel expenses. In all other areas, products must be returned to a service facility designated by Agilent Technologies.

For products returned to Agilent Technologies for warranty service, Buyer shall prepay shipping charges to Agilent Technologies and Agilent Technologies shall pay shipping charges to return the product to Buyer. However, Buyer shall pay all shipping charges, duties, and taxes for products returned to Agilent Technologies from another country.

Agilent Technologies warrants that its software and firmware designated by Agilent Technologies for use with an instrument will execute its programming instructions when properly installed on that instrument. Agilent Technologies does not warrant that the operation of the instrument, or software, or firmware will be uninterrupted or error free.

LIMITATION OF WARRANTY. The foregoing warranty shall not apply to defects resulting from improper or inadequate maintenance by Buyer, Buyer-supplied software or interfacing, unauthorized modification or misuse, operation outside of the environmental specifications for the product, or improper site preparation or maintenance.

NO OTHER WARRANTY IS EXPRESSED OR IMPLIED. AGILENT TECHNOLOGIES SPECIFICALLY DISCLAIMS THE IMPLIED WARRANTIES OR MERCHANTABILITY AND FITNESS FOR A PARTICULAR PURPOSE.

EXCLUSIVE REMEDIES. THE REMEDIES PROVIDED HEREIN ARE BUYER'S SOLE AND EXCLUSIVE REMEDIES. AGILENT TECHNOLOGIES SHALL NOT BE LIABLE FOR ANY DIRECT, INDIRECT, SPECIAL, INCIDENTAL, OR CONSEQUENTIAL DAMAGES, WHETHER BASED ON CONTRACT, TORT, OR ANY OTHER LEGAL THEORY.

Assistance

Product maintenance agreements and other customer assistance agreements are available for Agilent Technologies products.

For assistance, call your local Agilent Technologies Sales and Service Office (refer to [“Service and Support” on page v](#)).

Service and Support

By internet, phone, or fax, get assistance with all your test and measurement needs.

Online assistance: www.agilent.com/find/assist

United States (tel) 1 800 452 4844	Latin America (tel) (305) 269 7500 (fax) (305) 269 7599	Canada (tel) 1 877 894 4414 (fax) (905) 282-6495	Europe (tel) (+31) 20 547 2323 (fax) (+31) 20 547 2390
New Zealand (tel) 0 800 738 378 (fax) (+64) 4 495 8950	Japan (tel) (+81) 426 56 7832 (fax) (+81) 426 56 7840	Australia (tel) 1 800 629 485 (fax) (+61) 3 9210 5947	

Asia Call Center Numbers

Country	Phone Number	Fax Number
Singapore	1-800-375-8100	(65) 836-0252
Malaysia	1-800-828-848	1-800-801664
Philippines	(632) 8426802 1-800-16510170 (PLDT Subscriber Only)	(632) 8426809 1-800-16510288 (PLDT Subscriber Only)
Thailand	(088) 226-008 (outside Bangkok) (662) 661-3999 (within Bangkok)	(66) 1-661-3714
Hong Kong	800-930-871	(852) 2506 9233
Taiwan	0800-047-866	(886) 2 25456723
People's Republic of China	800-810-0189 (preferred) 10800-650-0021	10800-650-0121
India	1-600-11-2929	000-800-650-1101

Safety and Regulatory Information

Review this product and related documentation to familiarize yourself with safety markings and instructions before you operate the instrument. This product has been designed and tested in accordance with international standards.









WARNING

The **WARNING** notice denotes a hazard. It calls attention to a procedure, practice, or the like, that, if not correctly performed or adhered to, could result in personal injury. Do not proceed beyond a **WARNING** notice until the indicated conditions are fully understood and met.

CAUTION

The **CAUTION** notice denotes a hazard. It calls attention to an operating procedure, practice, or the like, which, if not correctly performed or adhered to, could result in damage to the product or loss of important data. Do not proceed beyond a **CAUTION** notice until the indicated conditions are fully understood and met.

Instrument Markings

	When you see this symbol on your instrument, you should refer to the instrument's instruction manual for important information.
	This symbol indicates hazardous voltages.
	The laser radiation symbol is marked on products that have a laser output.
	This symbol indicates that the instrument requires alternating current (ac) input.
	The CE mark is a registered trademark of the European Community. If it is accompanied by a year, it indicates the year the design was proven.
	The CSA mark is a registered trademark of the Canadian Standards Association.
1SM1-A	This text indicates that the instrument is an Industrial Scientific and Medical Group 1 Class A product (CISPER 11, Clause 4).
	This symbol indicates that the power line switch is ON.
	This symbol indicates that the power line switch is OFF or in STANDBY position.



Safety Earth Ground

This is a Safety Class I product (provided with a protective earthing terminal). An uninterruptible safety earth ground must be provided from the main power source to the product input wiring terminals, power cord, or supplied power cord set. Whenever it is likely that the protection has been impaired, the product must be made inoperative and secured against any unintended operation.

Before Applying Power

Verify that the product is configured to match the available main power source as described in the input power configuration instructions in this manual. If this product is to be powered by autotransformer, make sure the common terminal is connected to the neutral (grounded) side of the ac power supply.

Typeface Conventions

- Italics*
 - Used to emphasize important information:
Use this software *only* with the xxxxxX system.
 - Used for the title of a publication:
Refer to the xxxxxX *System-Level User's Guide*.
 - Used to indicate a variable:
Type LOAD BIN *filename*.
- Instrument Display**
 - Used to show on-screen prompts and messages that you will see on the display of an instrument:
The xxxxxX will display the message **CALL1 SAVED**.
- [Keycap]**
 - Used for labeled keys on the front panel of an instrument or on a computer keyboard:
Press **[Return]**.
- {Softkey}**
 - Used for simulated keys that appear on an instrument display:
Press **{Prior Menu}**.
- User Entry**
 - Used to indicate text that you will enter using the computer keyboard; text shown in this typeface must be typed *exactly* as printed:
Type LOAD PARMFILE
 - Used for examples of programming code:

```
#endif // ifndef NO_CLASS
```
- Path Name*
 - Used for a subdirectory name or file path:
Edit the file *usr/local/bin/sample.txt*
- Computer Display**
 - Used to show messages, prompts, and window labels that appear on a computer monitor:
The **Edit Parameters** window will appear on the screen.
 - Used for menus, lists, dialog boxes, and button boxes on a computer monitor from which you make selections using the mouse or keyboard:
Double-click **EXIT** to quit the program.

Contents

Notice	iii
Warranty	iii
Certification	iii
Assistance	iv
Service and Support	v
Safety and Regulatory Information	vi
Safety Earth Ground	vii
Before Applying Power	vii
Typeface Conventions	viii
General Information	1
Attenuator Overview	1
Safety Considerations	1
Specifications	2
<i>Table 1. Specifications</i>	2
<i>Table 2. Supplemental Characteristics</i>	2
Operating Environment	3
Storage and Shipping Environment	3
Mating Connectors	3
<i>Figure 1. Type N Connectors</i>	3
Installation	4
Initial Inspection	4
Preparation For Use	4
Operating Information	5
Principles of Operation	5
Operator's Check	5
Performance Tests	5
Service	6
Repair	6
Troubleshooting	7
<i>Figure 2. Attenuator Exploded View</i>	7
Replacement Parts	8
<i>Table 3. Replaceable Parts</i>	8
<i>Table 4. Attenuator Cartridge Assembly Parts (Item 16 in Figure 2)</i> ..	9

General Information

Attenuator Overview

The 8498A is a 30 dB, 30 W (25 W between +35° ×C and + 55° C) fixed attenuator with Type N connectors. Either connector may be used as the input or output connector.

- The attenuator is designed to work in a 50 ohm system, and operates over the frequency range from dc to 18.0 GHz.
- The attenuator may be used (1) to reduce a high power signal to a level that is compatible with sensitive equipment, (2) to reduce reflections, or (3) as a known attenuation for substitution.

Instruments Covered By Manual

The attenuators covered by this manual have a two-part serial number. The first four characters constitute the serial number prefix. The remaining digits form the sequential suffix that is unique to each attenuator.

The contents of this manual apply directly to the attenuators having the serial prefix US91. An attenuator manufactured after the printing of this manual may have a serial prefix that is not noted above. This unlisted serial prefix indicates that the attenuator differs in some respect from the information in this manual.

Warranty

The attenuator is warranted and certified as indicated on the warranty page of this manual. For further information, contact the nearest Agilent Technologies Sales and Service office. Refer to [“Service and Support” on page v](#).

The attenuator is warranted only when it is operated within its specifications. This is especially true of power handling capability. Any attenuator returned to Agilent Technologies under warranty will be examined carefully to determine if the failure was possibly due to improper use.

Safety Considerations

The warning that follows is related to possible personal injury.

WARNING

The high power attenuator card has a substrate of beryllium oxide. Beryllium oxide in a powder form is a hazardous material and may be injurious to your health if inhaled. Do not perform any operation on the beryllium oxide that might generate dust. Defective attenuator cards should be returned to Agilent Technologies for proper disposal.

Specifications

Instrument specifications are listed in Table 1. These specifications are the performance standards, or limits against which the attenuator may be tested.

Table 1 *Specifications*

Frequency Range	dc to 18.0 GHz
Attenuation	30 ± 1.0 dB
Input Impedance	50 ohm, nominal
Maximum SWR (reflection coefficient)	1.15 (0.07) dc to 8.0 GHz 1.25 (0.11) 8.0 to 12.4 GHz 1.30 (0.13) 12.4 to 18.0 GHz
Power Range	Up to 25 W CW
Maximum Input Power	Average ¹ 30 W at 0 to ≤+35° C 25 W at > +35° C up to +55° C Peak 500 W dc to ≤ 5.8 GHz 125 W > 5.8 GHz up to 18.0 GHz Energy per pulse 500 W/μs
Connectors	Type N (male and female) ²

1. For pulses greater than 30W the maximum average power (Pa) is limited by the energy per pulse (E) in W/μs according to $P_a = 30 - 0.02E$.

2. Compatible with IEE 287.

Supplemental characteristics in Table 2 are not specifications but are typical characteristics supplied as additional information for the user.

Table 2 *Supplemental Characteristics*

Temperature Stability	< 0.003 dB/° C
Power Sensitivity	< 0.006 dB/W
Dimensions	83 x 114 x 152 mm (approx. 3.25 x 4.5 x 6.0 in.)
Weight	0.6 kg (1.25 lbs.)

Operating Environment

The operating environment of the attenuator should be within the following limitations:

- Temperature.....0 to +55° C
- Humidity.....<95% relative at 40° C
- Altitude.....<4,600 meters (15,000 feet)

Storage and Shipping Environment

The attenuator should be stored in a clean, dry environment. The following environmental limitations apply to both storage and shipment:

- Temperature..... -40 to +75° C
- Humidity..... <95% relative at 40° C
- Altitude.....<15,300 meters (50,000 feet)

Mating Connectors

The attenuator has Type N connectors, one male and one female. These connectors mate with all Type N connectors whose dimensions are compatible with IEEE 287.

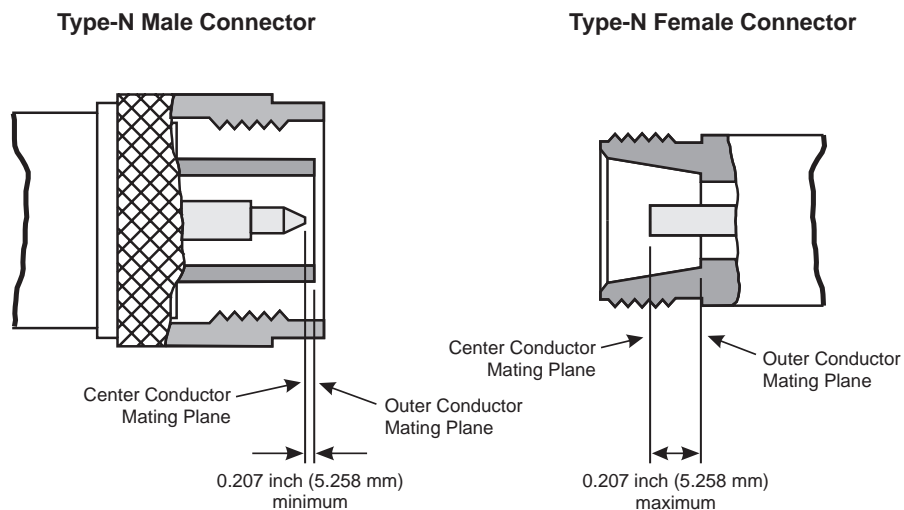

Figure 1 Type N Connectors

Installation

Initial Inspection

1. Inspect the shipping container for damage. If the shipping container or cushioning material is damaged, it should be kept until the contents of the shipment have been checked for completeness and the instrument has been checked mechanically and electrically.
2. If the contents are incomplete, if there is mechanical damage or defect, or if the instrument does not pass the electrical performance test, contact the nearest Agilent Technologies Sales and Service office. Refer to the Service and Support information in the front matter of this manual. Agilent Technologies will arrange for repair or replacement of the damaged or defective equipment. Keep the shipping materials for the carrier's inspection.
3. If you are returning the instrument for service, repackaging the instrument requires original shipping containers and materials or their equivalents. Agilent Technologies can provide packaging materials identical to the original materials. Refer to Service and Support information in the front matter of this manual for the Agilent Technologies nearest you. Attach a tag indicating the type of service required, return address, model number, and serial number. Mark the container **FRAGILE** to insure careful handling. In any correspondence, refer to the instrument by model number and serial number.

Preparation For Use

When you install the attenuator, make sure that the connectors do not support weight or bear torque. Take care not to drop or mechanically damaged the attenuator.

Operating Information

Principles of Operation

The attenuation is achieved by a resistive film deposition on a beryllium oxide substrate. The high power heat is dissipated by fins in the cooling cage that surrounds the attenuator cartridge assembly.

WARNING

The high power attenuator card has a substrate of beryllium oxide. Beryllium oxide in a powder form is a hazardous material and may be injurious to your health if inhaled. Do not perform any operation on the beryllium oxide that might generate dust. Defective attenuator cards should be returned to Agilent Technologies for proper disposal.

Operator's Check

The most accurate check of the attenuator is made using a network analyzer. However, a simplified operator's check of the attenuator can be made by using either the substitution or insertion loss method.

- If a similar attenuator of known accuracy is available, a reference can be established and then the unknown attenuator can be substituted in place of the reference attenuator. If a known good attenuator is not available, establish a reference on the measuring equipment, insert the device under test, and check for the proper attenuated signal level.
- Use an RF source in the proper frequency range and a detector with readout device. Equipment should have sufficient accuracy to show that the attenuator is working.

Performance Tests

The best method for testing the attenuator is with an automatic network analyzer or equivalent equipment of suitable accuracy. This method will allow greater accuracy of measurement since system ambiguities can be corrected. Simple quick-check techniques are mentioned under Operator's Check above. These techniques will provide a reasonable degree of confidence that the attenuator meets its specifications.

Service

Repair

Repair of the attenuator is limited to the replacement of the attenuator cartridge assembly (16) shown in Figure 2.

Refer to Figure 2 to identify the numbered items in the following procedure.

Attenuator Disassembly Procedure

1. Remove the 8 screws (10) that hold the two attenuator housings (9) and (30) and remove the housings.
2. Remove the three screws (36) and lock washers (35) from both ends of the attenuator assembly.
3. Remove the end fins (31) and (34), the RFI seals (11) and (19), spacers (33), and the framed attenuator fins (32).
4. Remove the three cap screws (12) from both ends of the attenuator assembly. It may be necessary to move the housing slightly to remove the screws.
5. Slide the inner connector bodies (14) and (18) from the attenuator cartridge assembly (16). Be careful not to let the sliding contacts (8) and (29) and compression springs (7) and (28) slide from the contact holders (6) and (27). Under normal conditions they will not slide out.
6. At this point the attenuator cartridge assembly (16) and the shim washers are free from the overall assembly and can be returned to Agilent Technologies. The attenuator cartridge assembly is the housing for the attenuator card, the card half sections, and the shims.

Attenuator Reassembly Procedure

1. Place the framed attenuator fins (32), “D” ring spacers (33), and end fins (31) and (34) on the attenuator cartridge assembly (16).
2. Position the RFI seals (11) and (19) and install end fins (31) and (34) with screws (36) and lock washers (35).
3. Install the connector assemblies with the six screws (12). Use the end of a toothpick to apply two small drops of Loctite 262 for each screw to the threads in the attenuator body (16). Tighten the screws evenly to a torque specification of 0.90 Nm (8 in-lbs).

CAUTION

Overtightening screws (12) beyond the specified torque may distort the card clamp half sections and fracture the attenuator card.

WARNING

Under no circumstances is the attenuator card to be machined, ground or scraped. Beryllium oxide in a powder form is a hazardous material may be injurious to your health if inhaled. Defective attenuator cards should be returned to Agilent Technologies for proper disposal.

4. Install the eight screws (10) that hold the two housings (9) and (30).

Troubleshooting

To troubleshoot the attenuator perform the operator's check. If the instrument does not perform within limits, check the connectors. If the connectors are not damaged, replace the attenuator cartridge assembly.

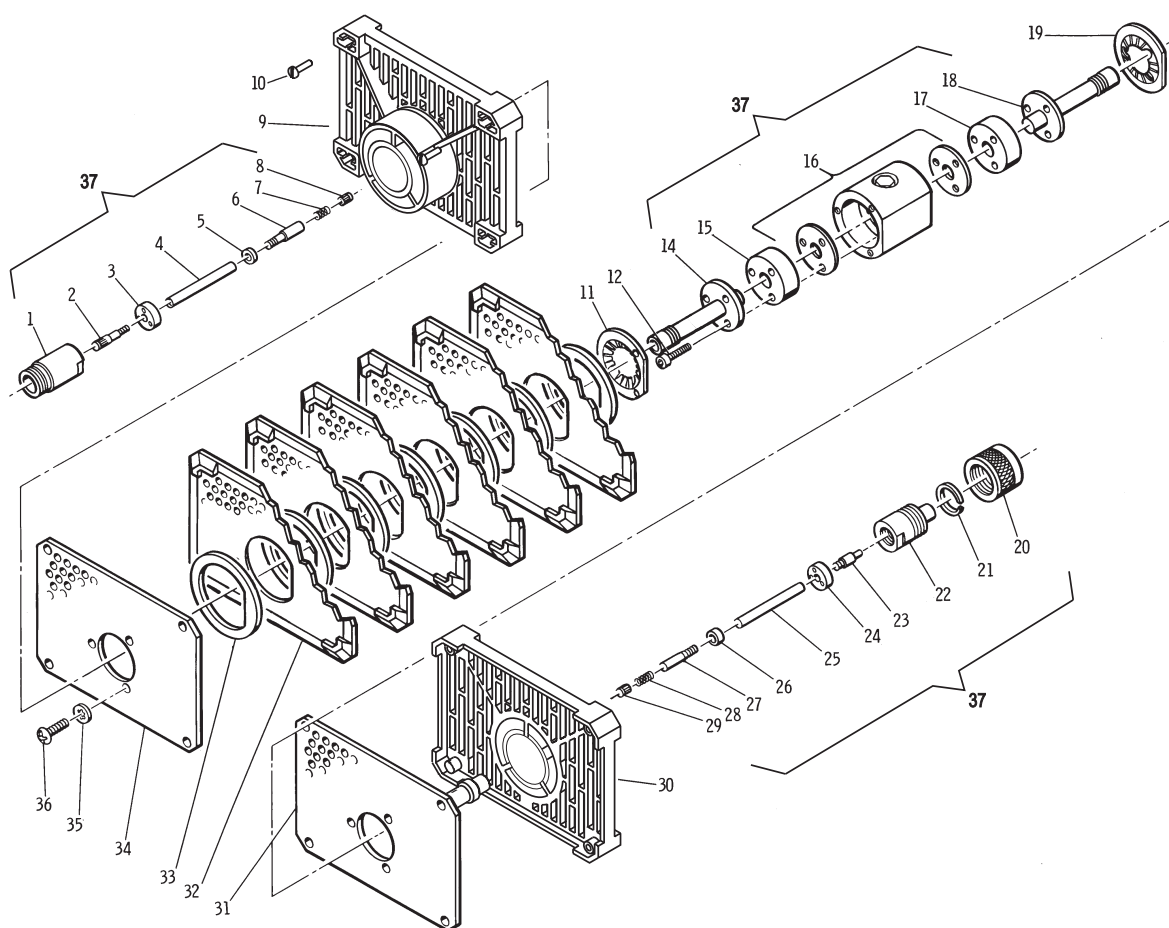

Figure 2 Attenuator Exploded View

Replacement Parts

To order a part listed in the replacement parts table, contact the nearest Agilent Technologies office. Refer to [“Service and Support” on page v](#).

Table 3 *Replaceable Parts*

Reference Designation	Part Number	QTY	Description
1	08498-80001	1	Outer connector body Type N, female
2	1250-0915	1	Contact-RF connector series 7 mm-N; female
3	5040-0306	2	Insulator
4	08498-20014	2	Center conductor
5	08498-20019	2	Damper
6	08498-20016	2	Contact holder
7	1460-1618	2	Spring-CPRSN .054-IN-OD .258-IN-0A-LG
8	5020-3297	2	Contact, sliding
9	08498-40002	2	Attenuator housing
10	2200-0145	8	Screw-MACH 4-40 .438-IN-LG PAN-HD-POZI
11	08498-20024	2	RFI seal
12	3030-0070	1	Screw-SKT HD CAP 4-40 .625-IN-LG ALY STL
	0470-1590	A/R	Loctite 262**
14	08498-20013	2	Inner connector body
15	08498-20018	2	Insulator
16	08498-60002	1	Attenuator cartridge assembly
17	08498-20018		Insulator
18	08498-20013		Inner connector body
19	08498-20024		RFI seal
20	1250-0918	1	Component-RF connector series 7 mm-N; SST
21	1250-0016	1	Component-RF connector series N; .75 IN
22	1250-0916	1	Body-RF connector series 7 mm-N straight
23	1250-0917	1	Contact-RF connector series 7 mm-N; male
24	5040-0306		Insulator
25	08498-20014		Center conductor
26	08498-20019		Damper

Table 3 *Replaceable Parts (Continued)*

Reference Designation	Part Number	QTY	Description
27	08498-20016		Contact holder
28	1460-1618		Spring-CPRSN .054-IN-OD .258-IN-0A-LG
29	5020-3297		Contact, sliding
30	08498-40002		Attenuator housing
31	08498-00002	2	End fin
32	08498-40001	6	Framed attenuator fin
33	08498-00005	1	D ring spacer*
34	08498-00002		End fin
35	2190-0014	1	Washer-LK INTL T NO. 2 .089-IN-ID
36	0520-0129	6	Screw-MACH 2-56 .312-IN-LG PAN-HD-POZI
37	08498-60006	1	Attenuator assembly
	7120-7127**	1	Label, identification

* NOTE: Some attenuators may have two spacers instead of one; 08498-00005 is the direct replacement.

** Not shown

Table 4 *Attenuator Cartridge Assembly Parts (Item 16 in Figure 2)*

Part	Qty.	Part Number
30 dB, 25W attenuator card	1	1GT1-2674
Attenuator body	1	08498-20011
Card clamp half section	2	08498-20025
Washer	2	08498-20017
Lock	2	08498-20022
Tuning screw	2	08498-20023