



Advanced Test Equipment Rentals
www.atecorp.com 800-404-ATEC (2832)

HP 8751A
Network Analyzer
Operation Manual

GERÄUSCHEMISSION

LpA < 70 dB
am Arbeitsplatz
normaler Betrieb
nach DIN 45635 T. 19

ACOUSTIC NOISE EMISSION

LpA < 70 dB
operator position
normal operation
per ISO 7779

AAKZ

HP 8751A NETWORK ANALYZER OPERATION MANUAL

SERIAL NUMBERS

This manual applies directly to instruments with serial number prefix 3315.
For additional important information about serial numbers, read
"Serial Number" in General Information of this Operation Manual.

OTS LIBRARY



HP Part No. 08751-90000
Microfiche Part No. 08751-90050
Printed in JAPAN August 1994

OTS LIBRARY



2400010846

Notice

The information contained in this document is subject to change without notice.

This document contains proprietary information which is protected by copyright. All rights are reserved. No part of this document may be photocopied, reproduced, or translated to another language without the prior written consent of the Hewlett-Packard Company.

Yokogawa-Hewlett-Packard, LTD.
Kobe Instrument Division
1-3-2, Murotani, Nishi-ku, Kobe-shi,
Hyogo, 651-22 Japan

Manual Printing History

The manual printing date and part number indicate its current edition. The printing date changes when a new edition is printed. (Minor corrections and updates which are incorporated at reprint do not cause the date to change.) The manual part number changes when extensive technical changes are incorporated.

October 1990	1st. Edition
January 1992	2nd. Edition
August 1994	3rd. Edition

Safety Summary

The following general safety precautions must be observed during all phases of operation, service, and repair of this instrument. Failure to comply with these precautions or with specific **WARNINGS** given elsewhere in this manual violates safety standards of design, manufacture, and intended use of the instrument.

The Hewlett-Packard Company assumes no liability for the customer's failure to comply with these requirements.

Ground The Instrument

This is a Safety Class 1 product (provided with a protective earthing terminal). An uninterruptible safety earth ground must be provided from the main power source to the product input wiring terminals, power source to the product input wiring terminals, power cord, or supplied power cord set. Whenever it is likely that the protection has been impaired, the product must be made inoperative and secured against any unintended operation.

DO NOT Operate In An Explosive Atmosphere

Do not operate the instrument in the presence of flammable gasses or fumes. Operation of any electrical instrument in such an environment constitutes a safety hazard.

Keep Away From Live Circuits

Operating personnel must not remove instrument covers. Component replacement and internal adjustments must be made by qualified maintenance personnel. Do not replace components with the power cable connected. Under certain conditions, dangerous voltages may exist even with the power cable removed. To avoid injuries, always disconnect power and discharge circuits before touching them.

DO NOT Service Or Adjust Alone

Do not attempt internal service or adjustment unless another person, capable of rendering first aid and resuscitation, is present.

DO NOT Substitute Parts Or Modify Instrument

Because of the danger of introducing additional hazards, do not substitute parts or perform unauthorized modifications to the instrument. Return the instrument to a Hewlett-Packard Sales and Service Office for service and repair to ensure the safety features are maintained.

Dangerous Procedure Warnings

Warnings, such as the example below, precede potentially dangerous procedures throughout this manual. Instructions contained in the warnings must be followed.

Warning



Dangerous voltages, capable of causing death, are present in this instrument. Use extreme caution when handling, testing, and adjusting this instrument.

How To Use This Manual

This is the Operating Manual for the HP 8751A Network Analyzer. This manual contains specifications, installation, configuration, and operation in the procedure following documentations. After you receive your HP 8751A, begin with chapter 1. of Users Guide.

For error messages of the HP 8751A, refer to Error Message in the Operation Manual.

Typeface Conventions

Bold Boldface type is used when a term is defined. For example: **icons** are symbols.

Italics Italic type is used for emphasis and for titles of manuals and other publications.

Italic type is also used for keyboard entries when a name or a variable must be typed in place of the words in italics. For example: *copy filename* means to type the word *copy*, to type a space, and then to type the name of a file such as *file1*.

Computer Computer font is used for on-screen prompts and messages.

HARDKEYS Labeled keys on the instrument front panel are enclosed in □.

SOFTKEYS Softkeys located to the right of the CRT are enclosed in ▢.

Certification

Hewlett-Packard Company certifies that this product met its published specifications at the time of shipment from the factory. Hewlett-Packard further certifies that its calibration measurements are traceable to the United States National Institute of Standards and Technology, to the extent allowed by the Institution's calibration facility, or to the calibration facilities of other International Standards Organization members.

Warranty

This Hewlett-Packard instrument product is warranted against defects in material and workmanship for a period of one year from the date of shipment, except that in the case of certain components listed in *General Information* of this manual, the warranty shall be for the specified period. During the warranty period, Hewlett-Packard Company will, at its option, either repair or replace products which prove to be defective.

For warranty service or repair, this product must be returned to a service facility designated by HP. Buyer shall prepay shipping charges to HP and HP shall pay shipping charges to return the product to Buyer. However, Buyer shall pay all shipping charges, duties, and taxes for products returned to HP from another country.

HP warrants that its software and firmware designated by HP for use with an instrument will execute its programming instruction when properly installed on that instrument. HP does not warrant that the operation of the instrument, or software, or firmware will be uninterrupted or error free.

Limitation Of Warranty

The foregoing warranty shall not apply to defects resulting from improper or inadequate maintenance by Buyer, Buyer-supplied software or interfacing, unauthorized modification or misuse, operation outside of the environmental specifications for the product, or improper site preparation or maintenance.

No other warranty is expressed or implied. HP specifically disclaims the implied warranties of merchantability and fitness for a particular purpose.

Exclusive Remedies

The remedies provided herein are buyer's sole and exclusive remedies. HP shall not be liable for any direct, indirect, special, incidental, or consequential damages, whether based on contract, tort, or any other legal theory.

Assistance

Product maintenance agreements and other customer assistance agreements are available for Hewlett-Packard products.

For any assistance, contact your nearest Hewlett-Packard Sales and Service Office. Address are provided at the back of this manual.

Safety Symbols

General definitions of safety symbols used on equipment or in manuals.



Instruction manual symbol: the product will be marked with this symbol when it is necessary for the user to refer to the instruction manual in order to protect against damage to the instrument.



Indicates dangerous voltage (terminals fed from the interior by voltage exceeding 1000 volts must be so marked).

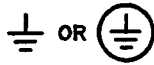

Protective conductor terminal. For protection against electrical shock in case of a fault. Used with wiring terminals to indicate the terminal which must be connected to ground before operating equipment.



Low-noise or noiseless, clean ground (earth) terminal. Used for a signal common, as well as providing protection against electrical shock in case of fault. A terminal marked with this symbol must be connected to ground in the manner described in the installation (Operation) manual, and before operating the equipment.

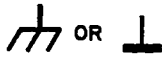

Frame or chassis terminal. A connection to the frame (chassis) of the equipment which normally includes all exposed metal structures.



Alternating current (power line).



Direct current (power line).



Alternating or direct current (power line).

Warning



Warning denotes a hazard. It calls attention to a procedure, practice, condition or the like, which, if not correctly performed or adhered to, could result in injury or death to personnel.

Caution



Caution sign denotes a hazard. It calls attention to a procedure, practice, condition or the like, which, if not correctly performed or adhered to, could result damage to or destruction of part or all of the product.

Note



Note denotes important information. It calls attention to a procedure, practice, condition or the like, which is essential to highlight.

HP 8751A NETWORK ANALYZER
General Information



Printed in JAPAN August 1994



Contents

1. General Information	
ABOUT THIS MANUAL SET	1-1
Instruments Covered by This Manual	1-1
Microfiche Copies of the Manual	1-1
HP 8751A DESCRIPTION	1-2
Additional Features	1-2
Advanced List Sweep Mode	1-2
Automatic Sweep Time	1-2
Automatic Interpolated Error Correction	1-2
Conjugate Matching	1-3
Four Trace Simultaneous Measurement	1-3
HP Instrument BASIC (Option 002)	1-3
I/O port	1-3
Waveform Analysis Commands	1-3
System Description	1-3
HEWLETT-PACKARD INTERFACE BUS (HP-IB)	1-4
OPTIONS AVAILABLE	1-4
Option 001, High Stability Frequency Reference	1-4
Option 002, HP Instrument BASIC	1-4
Option 008, Add Japanese Manual Set	1-4
Option 009, Delete Manual Set	1-4
Option 907, Front Handle Kit	1-4
Option 908, Rack Mount Kit	1-5
Option 909, Rack Mount Flange and Handle Kit	1-5
Option 910, Extra Manual Set	1-5
Option 915, Add Service Manual (HP Part Number: 08751-90031)	1-5
TEST SETS REQUIRED	1-5
HP 87511A,B S-Parameter Test Sets	1-5
HP 87512A,B Transmission/Reflection Test Kits	1-5
Other Test Sets Available	1-5
HP 85046A,B S-parameter Test Sets	1-5
HP 85044A,B Transmission/Reflection Test Sets	1-5
MEASUREMENT ACCESSORIES AVAILABLE	1-6
Power Splitters	1-6
HP 11850C,D Three-Way Power Splitters	1-6
HP 11667A Power Splitter	1-6
Active Probes	1-6
HP 41800A Active Probe	1-6
HP 41802A 1 M Ω Input Adapter	1-6
Calibration Kits	1-6
Test Port Return Cables	1-6
HP 11857D 7 mm Test Port Return cable Set	1-7

HP 11857B 75 Ω Type-N Test Port Return Cable Set	1-7
HP 11851B 50 Ω Type-N RF Cable Set	1-7
Adapter Kits	1-7
HP 11852B 50 Ω to 75 Ω Minimum Loss Pad	1-7
SYSTEM ACCESSORIES AVAILABLE	1-8
System Rack	1-8
Plotters and Printers	1-8
HP-IB Cables	1-8
Computer	1-8
Disks and Disk Accessories	1-9
External Monitors	1-9
RECOMMENDED TEST EQUIPMENT	1-9

2. Instrument Specifications

SOURCE	2-1
Frequency Characteristics	2-1
Output Power Characteristics	2-1
Spectral Purity Characteristics	2-2
Sweep Characteristics	2-2
Frequency Sweep	2-2
Power Sweep	2-2
Others	2-2
RECEIVER	2-3
Input Characteristics	2-3
Magnitude Characteristics	2-4
Absolute Characteristics	2-4
Ratio Characteristics	2-5
Phase Characteristics	2-6
Delay Characteristics	2-7
DC Voltage Measurement Characteristics for INPUT B	2-8
GENERAL CHARACTERISTICS	2-8
REAR PANEL SPECIFICATIONS	2-9
I/O Buses	2-9
HP-IB Interface	2-9
S-Parameter Test Set Interface	2-9
I/O Port	2-9
BNC Connectors	2-9
"EXT REF INPUT 10/N MHz" Connector	2-9
"REF OVEN (OPTION 001)" Connector	2-10
"INT REF OUTPUT" Connector	2-10
"EXT TRIGGER" Connector	2-10
"EXT PROG RUN/CONT" Connector	2-10
"EXT MONITOR" Connectors	2-10
FURNISHED ACCESSORIES	2-11
TYPICAL SYSTEM PERFORMANCE	2-13
Introduction	2-13
Comparison Of Typical Error-Corrected Measurement Uncertainty	2-13
Reflection Uncertainty of a One-Port Device	2-14
Reflection Uncertainty of a Two-Port Device	2-15
Transmission Uncertainty of a Low-Loss Device	2-16
Transmission Uncertainty of a Wide Dynamic Range Device	2-17

TYPES OF RESIDUAL MEASUREMENT ERRORS	2-18
Residual Systematic Errors	2-18
Residual Random Errors	2-18
Residual Drift Errors	2-18
SYSTEM ERROR MODE	2-19
REFLECTION UNCERTAINTY EQUATIONS	2-21
Total Reflection Magnitude Uncertainty (E_{rm})	2-21
Total Reflection Phase Uncertainty (E_{rp})	2-21
TRANSMISSION UNCERTAINTY EQUATIONS	2-22
Total Transmission Magnitude Uncertainty (E_{tm})	2-22
Total Transmission Phase Uncertainty (E_{tp})	2-22
DYNAMIC ACCURACY	2-23
Definitions	2-23
Determining Relative Dynamic Accuracy Error Contribution	2-23
Dynamic Accuracy Error Contribution	2-24
Dynamic Accuracy Error Contribution	2-25
Dynamic Accuracy Error Contribution	2-26
EFFECTS OF TEMPERATURE DRIFT	2-27
Temperature Drift with S_{11} One-Port Calibration	2-28
Temperature Drift with Full Two-Port Calibration	2-29
SYSTEM PERFORMANCE WITH DIFFERENT TEST SETS AND CONNECTOR TYPES	2-30
DETERMINING EXPECTED SYSTEM PERFORMANCE	2-32
Procedures	2-32

Figures

1-1. Typical Serial Number Plate	1-1
2-1. Average Noise Level on Magnitude Measurement	2-4
2-2. Dynamic Accuracy (Amplitude)	2-5
2-3. Dynamic Accuracy (Phase)	2-7
2-4. S-Parameter Test Set Interface Pin Assignments	2-9
2-5. Trigger Signal	2-10
2-6. Power Cables Supplied	2-12
2-7. Total Reflection Magnitude Uncertainty	2-14
2-8. Total Reflection Phase Uncertainty	2-14
2-9. Total Reflections Magnitude Uncertainty	2-15
2-10. Total Reflection Phase Uncertainty	2-15
2-11. Total Transmission Magnitude Uncertainty	2-16
2-12. Total Transmission Phase Uncertainty	2-16
2-13. Total Transmission Magnitude Uncertainty	2-17
2-14. Total Transmission Phase Uncertainty	2-17
2-15. HP 8751A/87511A System Error Model	2-19
2-16. Worst-Case Magnitude Dynamic Accuracy Error	2-24
2-17. Worst-Case Phase Dynamic Accuracy Error	2-24
2-18. Worst-Case Magnitude Dynamic Accuracy Error	2-25
2-19. Worst-Case Phase Dynamic Accuracy Error	2-25
2-20. Worst-Case Magnitude Dynamic Accuracy Error	2-26
2-21. Worst-Case Phase Dynamic Accuracy Error	2-26
2-22. Total Reflection Magnitude Uncertainty	2-28
2-23. Total Reflection Phase Uncertainty	2-28
2-24. Total Transmission Magnitude Uncertainty	2-29
2-25. Total Transmission Phase Uncertainty	2-29

Tables

1-1. Disks and Disk Accessories	1-9
2-1. Parameters of System Error Model	2-20
2-2. Determining Relative Dynamic Accuracy (Linacc)	2-23
2-3. Typical System Performance for Devices	2-31
2-4. Reflection Measurement Uncertainty Worksheet	2-33
2-5. Transmission Measurement Uncertainty Worksheet	2-34

General Information

ABOUT THIS MANUAL SET

This *HP 8751A Network Analyzer Operation Manual* is a complete guide to operating the analyzer alone or as a component in a system. It is part of a two manual set; the *Maintenance Manual* completes the set.

To explore the manuals further, inspect their title pages and the “Contents” and “Index” sections.

Instruments Covered by This Manual

The instrument you received with this manual is covered by this manual without change. Any other instrument with one of the serial number prefixes listed on the title page is also described by this manual. (The serial number plate, shown in Figure 1-1, is attached to the rear panel of the analyzer.)

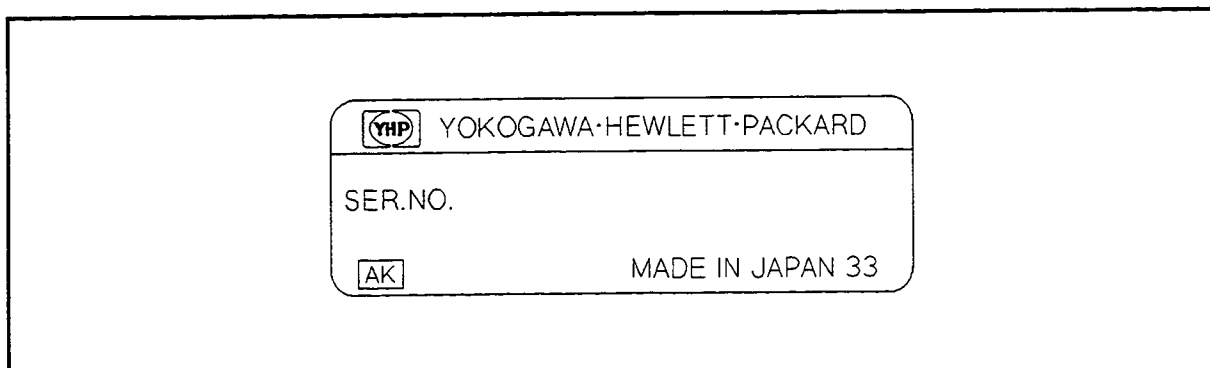

C2101002

Figure 1-1. Typical Serial Number Plate

Other instruments differ from the instruments covered directly by this manual. Those differences are documented in the “Instrument History” section. See “Instrument History” section if the serial number prefix of your instrument is not listed on the title page.

Microfiche Copies of the Manual

Use the microfiche part number on the title page to order a package of 10 × 15 centimeter (4 × 6 inch) microfilm transparencies of this manual and the *Maintenance manual*.

HP 8751A DESCRIPTION

The HP 8751A is a 5 Hz to 500 MHz vector network analyzer for reflection and transmission parameters. It integrates a high resolution synthesized RF source, and a dual channel and three-input receiver to measure and display magnitude, phase, and group delay responses of active and passive RF networks. Option 001 provides a high stability frequency reference. For information on other options, refer to "OPTIONS AVAILABLE" later in this section.

Two independent display channels and a large screen color CRT display the measured results of one or both channels, in rectangular or polar/Smith chart formats. The display function has capability to display three trace simultaneously.

Digital signal processing and microprocessor control combine to provide easy operation and measurement improvement. Measurement functions are selected with front panel keys and softkey menus. Displayed measurement results can be printed or plotted directly with a compatible peripheral without the use of an external computer. A built-in micro flexible disk drive stores and recalls instrument states and trace data (measurement data). Built-in service diagnostics are available to simplify troubleshooting procedures.

Trace math, data averaging, trace smoothing, electrical delay, and accuracy enhancement provide performance improvement and flexibility. Accuracy enhancement methods range from normalizing data to complete one or two port vector error correction. Vector error correction reduces the effects of system directivity, frequency response, source and load match, and crosstalk.

In combination with its compatible test sets and accessories, the analyzer has the ability to make complete reflection and transmission measurements in both 50 and 75 Ω impedance environments.

Additional Features

In addition to the above capabilities, this analyzer has several features:

Advanced List Sweep Mode

The analyzer can measure specifically at user defined frequencies, power levels, IF bandwidths, and number of points as defined in List Segment. The list sweep mode can make the display resolution even, even though the frequency points are not evenly distributed, as well as making the frequency base display even.

Automatic Sweep Time

The analyzer can automatically shorten sweep time as much as possible for the given IF bandwidth, number of points, averaging mode, frequency range, and sweep type.

Automatic Interpolated Error Correction

This allows the operator to perform any type of calibration, and then display any subset of that frequency range or use a different number of points. If the operator changes the stimulus parameter, the analyzer turns the interpolated error correction on, and new error coefficients are interpolated from the coefficients of the original calibration. Interpolated error correction provides a great improvement over uncorrected measurements, but is not specified. Refer to *Chapter 7*.

HP 8751A Description

Conjugate Matching

This calculates the optimum parameters of devices in assumed two element L-C impedance matching networks at a DUT end to obtain optimum power transfer at a specific frequency. Several types of the assumed matching circuit will be selected automatically from among the eight provided candidates depending on the DUT's characteristics.

The operator can simulate the circuit after modifying the parameters to suit to commercially available values.

Four Trace Simultaneous Measurement

The analyzer can measure and display two traces for one channel, which allows four traces simultaneous display using the dual channel display capability. In addition, stimulus values (frequency, power) can range independently for each channel.

HP Instrument BASIC (Option 002)

This allows analyzer programmability without any external controller. HP Instrument BASIC is a subset of HP BASIC and allows all of the analyzer's measurement capabilities and any other HP-IB compatible instrument to be programmed. (Refer to *Using HP Instrument BASIC with the HP 8751A.*)

I/O port

This allows the creation of a production line measurement system when used with an automatic handler. Refer to Appendix C for more information.

Waveform Analysis Commands

The waveform analysis function provides filter and resonator specific measurement commands. These commands can be used to analyze filter ripple, obtain filter parameters (for example 3 dB bandwidth), or to search for a resonator's series-resonant mode frequency and its parallel-resonant mode (antiresonant) frequency. Executing a command derives parameters from measurement results and returns the derived parameters by HP-IB. An external controller or HP Instrument BASIC (Option 002) is required to use this command set. These commands cannot be executed from the front panel.

System Description

An HP 8751A system consists of the analyzer with one of the following test sets/accessories:

- HP 87511A,B S-parameter test set
- HP 87512A,B transmission/reflection test kit
- HP 11850C,D or 11667A power splitter

In addition to one of the above, a system requires a compatible Hewlett-Packard calibration kit and the necessary cables. The compatible test sets, power splitters, calibration kits, and cables are described under "TEST SETS REQUIRED" and "MEASUREMENT ACCESSORIES AVAILABLE" later in this section.

The system may also include other compatible peripherals such as a printer or plotter. The printer and plotter are described under "SYSTEM ACCESSORIES AVAILABLE" .

Options Available

The system can be automated with the addition of an HP 9000 series 200 or 300 computer, this allows all of the measurement capabilities to be programmed over the Hewlett-Packard Interface Bus (HP-IB).

HEWLETT-PACKARD INTERFACE BUS (HP-IB)

The analyzer is factory-equipped with a remote programming interface using the Hewlett-Packard Interface Bus (HP-IB). HP-IB is Hewlett-Packard's hardware, software, documentation, and support for IEEE-488.1, IEEE-488.2, IEC-625, and JIS-C1901 worldwide standards for interfacing instruments. This provides a remote operator with the same control of the instrument available to the local operator, except for control of the power line switch and some internal tests. Remote control is maintained by a controlling computer that sends commands or instructions to and receives data from the analyzer using HP-IB. Several output modes are available for output data. A complete general description of HP-IB is available in *Condensed description of the Hewlett-Packard Interface Bus* (HP part number 59401-90030), and in *the Tutorial Description of the Hewlett-Packard Interface Bus* (HP literature number 5952-0156).

The analyzer itself can use HP-IB to output measurement results directly to a compatible printer or plotter without the use of an external computer.

OPTIONS AVAILABLE

Option 001, High Stability Frequency Reference

This option, a 10 MHz crystal in temperature stabilized oven, improves the source signal frequency accuracy and stability.

Option 002, HP Instrument BASIC

See the previous section for information.

Option 008, Add Japanese Manual Set

Option 009, Delete Manual Set

Option 907, Front Handle Kit

Test Sets Required**Option 908, Rack Mount Kit**

This option is a rack mount kit containing a pair of flanges and the necessary hardware to mount the instrument, with handles detached, in an equipment rack with 482.6 mm (19 inches) horizontal spacing.

Option 909, Rack Mount Flange and Handle Kit

This option is a rack mount kit containing a pair of flanges and the necessary hardware to mount the instrument with handles attached in an equipment rack with 482.6 mm (19 inches) horizontal spacing.)

Option 910, Extra Manual Set

This option is an extra manual set containing the same manual set which is furnished with the analyzer.

Option 915, Add Service Manual (HP Part Number: 08751-90031)

TEST SETS REQUIRED**HP 87511A,B S-Parameter Test Sets**

These contain the hardware required to make simultaneous transmission and reflection measurement in both the forward and reverse directions for system impedances of 50 or 75 Ω . An RF switch in the set is controlled by the analyzer so that reverse measurement can be made without changing the connections to the device under test.

HP 87512A,B Transmission/Reflection Test Kits

These contain the hardware required to make simultaneous transmission and reflection measurement in one direction only for system impedances of 50 or 75 Ω .

Other Test Sets Available**HP 85046A,B S-parameter Test Sets**

These measure the response of devices from 300 kHz to 500 MHz with the HP 8751A. These contain two internal DC bias tees for biasing of active devices.

HP 85044A,B Transmission/Reflection Test Sets

These measure the response of devices from 300 kHz to 500 MHz with the HP 8751A. These include a 0 to 70 dB step attenuator manually controllable in 10 steps, and the circuitry necessary to allow biasing of active devices through the test set.

MEASUREMENT ACCESSORIES AVAILABLE

Power Splitters

HP 11850C,D Three-Way Power Splitters

These are four-port, three-way power splitters. One output is used as the reference for the network analyzer in making ratio measurements and the other two output arms are test channels. The HP 11850C has a frequency range of DC to 3 GHz and an impedance of 50 Ω the HP 11850D has a frequency range of DC to 2 GHz and an impedance of 75 Ω . Three HP 11852B 50 to 75 Ω minimum loss pads are supplied with the HP 11850D power splitter, to provide a low SWR impedance match between the power splitter and the 50 Ω ports of the network analyzer.

HP 11667A Power Splitter

This is a two-way power splitter with one output arm used for reference and one for test. It has a frequency range of DC to 18 GHz and an impedance of 50 Ω .

Active Probes

HP 41800A Active Probe

This is a high input impedance probe for in-circuit measurement which covers the same frequency range as the HP 8751A.

HP 41802A 1 M Ω Input Adapter

This adapter allows use of a high impedance probe. It has a frequency range of 5 Hz to 100 MHz.

Calibration Kits

The following calibration kits contain precision standards (and required adapters) of the indicated connector type. The standards (known devices) facilitate measurement calibration, also called vector error correction. Refer to the data sheet and ordering guide for additional information. Part numbers for the standards are in their respective manuals.

- HP 85031B 7 mm Calibration Kit
- HP 85032B 50 Ω Type-N Calibration Kit
- HP 85036B 75 Ω Type-N Calibration Kit

Test Port Return Cables

The following RF cables are used to return the transmitted signal to the test set in measurement of two-port devices. These cables provide shielding for high dynamic range measurements.

Measurement Accessories Available**HP 11857D 7 mm Test Port Return cable Set**

These are a pair of test port return cables for use with the HP 87511A or HP 85046A S-parameter test sets. The cables can be used in measurements of devices with connectors other than 7 mm by using the appropriate precision adapters.

HP 11857B 75 Ω Type-N Test Port Return Cable Set

These are a pair of test port return cables for use with the HP 87511B or HP 85046B S-parameter test sets.

HP 11851B 50 Ω Type-N RF Cable Set

This kit contains the three phase-matched 50 Ω type-N cables necessary to connect the HP 87512A,B or HP 85044A,B transmission/reflection test kit or a power splitter to the analyzer, as well as an RF cable to return the transmitted signal of a two-port device to the network analyzer. For use with the HP 87512B or HP 85044B test kit, the HP 11852B 50 Ω to 75 Ω minimum loss pad supplied with the test kit must be used for impedance matching with the RF return cable.

Adapter Kits**HP 11852B 50 Ω to 75 Ω Minimum Loss Pad**

This device converts impedance from 50 Ω to 75 Ω or from 75 Ω to 50 Ω . It is used to provide a low SWR impedance match between a 75 Ω device under test and the HP 8751A network analyzer or a 50 Ω measurement accessory. An HP 11852B pad is included with the HP 87512B and HP 85044B 75 Ω transmission/reflection test kit. Three HP 11852B pads are included with the HP 11850D 75 Ω power splitter.

These adapter kits contain the connection hardware required for making measurements on devices of the indicated connector type.

- HP 11853A 50 Ω Type-N Adapter Kit
- HP 11854A 50 Ω BNC Adapter Kit
- HP 11855A 75 Ω Type-N Adapter Kit
- HP 11856A 75 Ω BNC Adapter Kit

SYSTEM ACCESSORIES AVAILABLE

System Rack

The HP 85043B system rack is a 124 cm (49 inch) high metal cabinet designed to rack mount the analyzer in a system configuration. The rack is equipped with a large built-in work surface, a drawer for calibration kits and other hardware, a bookshelf for system manuals, and a locking rear door for secured access. Lightweight steel instrument support rails support the instrument along their entire depth. Heavy-duty casters make the cabinet easily movable even with the instruments in place. Screw-down lock feet permit leveling and semi-permanent installation: the cabinet is extremely stable when the lock feet are down. Power is supplied to the cabinet through a heavy-duty grounded primary power cable, and to the individual instruments through special power cables included with the cabinet.

Plotters and Printers

The HP 8751A is capable of plotting displayed measurement results directly to a compatible peripheral without the use of an external computer. The Compatible plotters are:

- HP 7440A Option 002 ColorPro Eight-Pen Color Graphics Plotter, plots on ISO A4 or 8 1/2 × 11 inch charts.
- HP 7475A Option 002 Six-Pen Graphics Plotter, plots on ISO A4/A3 or 8 1/2 × 11 inch or 11 × 17 inch charts.
- HP 7550B Option 002 High-Speed Eight-Pen Graphics Plotter, plots on ISO A4/A3 or 8 1/2 × 11 inch or 11 × 17 inch charts.

The compatible printers for both printing and plotting are:

- HP 3630A Paintjet Option 002 color printer
- HP 2225A (HP-IB compatible) ThinkJet printer
- HP 2227B QuietJet Option 002 printer

HP-IB Cables

An HP-IB cable is required for interfacing the analyzer with a plotter, printer, computer, or other external instrument. The cables available are HP 10833A (1 m), HP 10833B (2 m), and HP 10833D (0.5 m).

Computer

An external controller is not required for measurement calibration. However, the system can be automated with the addition of HP Instrument BASIC (Option 002) or the HP 9000 200,300 series computer.

Recommended Test Equipment

Disks and Disk Accessories

Hewlett-Packard disks are listed below.

Table 1-1. Disks and Disk Accessories

HP Parts Number	Description
92192A	Box of 10 3.5 inch, 720K byte microfloppy disks
92192N	Box of 100 3.5 inch, 720K byte microfloppy disks
92192X	Box of 10 3.5 inch, 1.44M byte microfloppy disks
92191R	Rosewood roll-top disk holder. Holds 50 disks.
92191Q	Acrylic lift-top disk holder. Holds 25 disks.
92191T	Bookshelf-style folding plastic disk holder. Holds 10 disks.
92191H	Disk Library binder. Holds 20 disks initially.

External Monitors

The analyzer can drive both its internal CRT and an external monitor simultaneously. One recommended color monitor is the HP 35741A,B. A monochrome monitor, such as the HP 35731A,B, may also be used if the analyzer is operated in the monochrome mode.

RECOMMENDED TEST EQUIPMENT

Equipment required to test, adjust, and the system is listed in the beginning of the *Maintenance Manual* and the *Service Manual*. Other equipment may be substituted if it meets or exceeds the listed critical specifications.

Instrument Specifications

These specifications are the performance standards or limits against which the instrument is tested. When shipped from the factory, the HP 8751A meets the specifications listed in this section. The specification test procedures are covered in *HP 8751A Maintenance Manual*.

Supplement characteristics are intended to provide information that is useful in applying the instrument by giving non-warranted performance parameters. These are denoted as "Typical", "Typ." or "Nominal".

SOURCE

Frequency Characteristics

Range	5 Hz to 500 MHz
Accuracy	
at $23 \pm 5^\circ\text{C}$	$\pm(20 \text{ ppm} + 1 \text{ mHz})$
at 0 to 55°C (with Opt. 001, 20 minutes after power on)	$\pm(1.0 \text{ ppm} + 1 \text{ mHz})$
Stability (at $23 \pm 5^\circ\text{C}$)	
Typical	$\pm 5 \times 10^{-6}/\text{day}$
Typical with Opt. 001, 48 hours after power on	$\pm 2.5 \times 10^{-9}/8 \text{ hours}$
Resolution	1 mHz

Output Power Characteristics

Range	-50 to +15 dBm
Resolution	0.1 dB
Level Accuracy (at $23 \pm 5^\circ\text{C}$, 0 dBm output level, 50 MHz)	$\pm 0.5 \text{ dB}$
Flatness (at $23 \pm 5^\circ\text{C}$, 0 dBm output level relative to 50 MHz)	
5 Hz \leq Freq. \leq 1 MHz	$\pm 2.0 \text{ dB}$
1 MHz $<$ Freq. \leq 300 MHz	$\pm 1.5 \text{ dB}$
300 MHz $<$ Freq. \leq 500 MHz	$\pm 2.0 \text{ dB}$
Linearity (at $23 \pm 5^\circ\text{C}$, relative to 0 dBm output level at 50 MHz)	
Output Level \geq -35 dBm	$\pm 0.5 \text{ dB}$
Output Level $<$ -35 dBm	$\pm 1.5 \text{ dB}$
Impedance	
Nominal	50 Ω
Return Loss (at 0 dBm, typical)	$> 15 \text{ dB}$

Source

Spectral Purity Characteristics

Harmonics (at +10 dBm output level)	< -30 dBc
Non-harmonic Spurious Signals (at 0 dBm output level)	< -45 dBc
Phase Noise (at 20 kHz offset from 0 dBm fundamental)	< -75 dBc/Hz

Sweep Characteristics

Frequency Sweep

Same as the Frequency Characteristics.

Power Sweep

Maximum Span 25 dB to 35 dB

Note

The sweep start power is determined by the sweep stop power.



Stop Power Range	Start Power
+5 dBm to +15 dBm	≥ -20 dBm
-5 dBm to +5 dBm	≥ -30 dBm
-15 dBm to -5 dBm	≥ -40 dBm
-50 dBm to -15 dBm	≥ -50 dBm

Resolution 0.1 dB

Linearity (at $23 \pm 5^\circ\text{C}$, Reference: Stop Power)

Start Power ≥ -45 dBm

	Span $\leq +20$ dB	Span $> +20$ dB
CW Freq. ≤ 300 MHz	$\pm(0.3 \text{ dB}/10 \text{ dB} + 0.2 \text{ dB})$	$\pm(0.3 \text{ dB}/10 \text{ dB} + 1.0 \text{ dB})$
CW Freq. > 300 MHz	$\pm(1.0 \text{ dB}/10 \text{ dB} + 0.2 \text{ dB})$	$\pm(1.0 \text{ dB}/10 \text{ dB} + 1.0 \text{ dB})$

Start Power < -45 dBm

	Span $\leq +20$ dB	Span $< +20$ dB
CW Freq. ≤ 300 MHz	$\pm(0.3 \text{ dB}/10 \text{ dB} + 1.2 \text{ dB})$	$\pm(0.3 \text{ dB}/10 \text{ dB} + 2.0 \text{ dB})$
CW Freq. > 300 MHz	$\pm(1.0 \text{ dB}/10 \text{ dB} + 1.2 \text{ dB})$	$\pm(1.0 \text{ dB}/10 \text{ dB} + 2.0 \text{ dB})$

Others

Reverse Power Protection None (Neither AC nor DC)
Output Connector Type N female, 50 Ω , Single ended

RECEIVER**Input Characteristics**

Frequency Range 5 Hz to 500 MHz
 Impedance
 Nominal 50 Ω
 Return Loss

	ATT = 0 dB	ATT = 20 dB
5 Hz \leq Freq. \leq 100 MHz	> 20 dB	> 25 dB
100 MHz < Freq. \leq 300 MHz	> 15 dB	> 25 dB
300 MHz < Freq. \leq 500 MHz	> 10 dB	> 20 dB

Maximum Input Level

	ATT = 0 dB	ATT = 20 dB
5 Hz \leq Freq. \leq 4 kHz	-26 dBm	-6 dBm
4 kHz < Freq. \leq 10 kHz	-21 dBm	-1 dBm
10 kHz < Freq. \leq 500 MHz	-20 dBm	0 dBm

Damage Level

DC ± 3 V (Typ.)
 At ATT = 0 dB +15 dBm (Typ.)
 At ATT = 20 dB +20 dBm (Typ.)

Receiver

Noise Level (at $23 \pm 5^\circ\text{C}$)

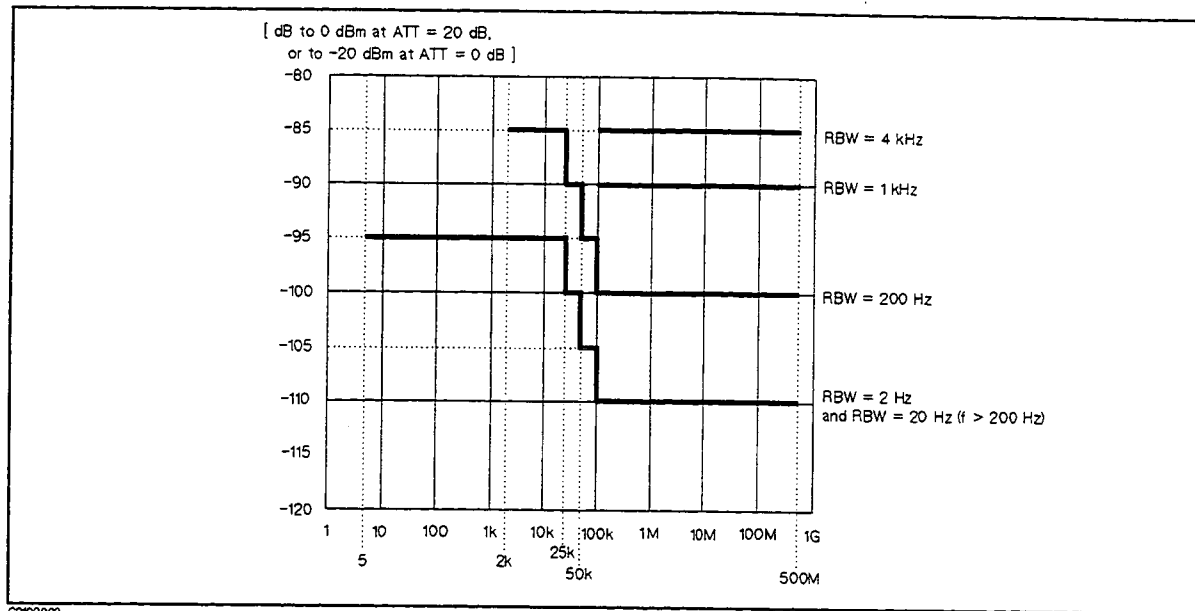

Figure 2-1. Average Noise Level on Magnitude Measurement

IF Bandwidth (IF BW)	2 Hz, 20 Hz, 200 Hz, 1 kHz, and 4 kHz (Nominal)
Input Crosstalk (at the same ATT setting for both input ports)	
Freq. < 10 kHz	< -95 dB
Freq. \geq 10 kHz	< -100 dB
Source Crosstalk (at +15 dBm output level, ATT = 0 dB)	
Freq. < 10 kHz	< -100 dB (Typ.)
Freq. \geq 10 kHz	< -135 dB (Typ.)
Input Connector	Type N female, 50 Ω , single ended, 3 inputs (R, A, and B)

Magnitude Characteristics

Absolute Characteristics

Display Range (Ref. value can be set to)	± 500 dBm
Display Resolution (/div can be set to)	0.001 dB/div to 500 dB/div
Marker Resolution	0.001 dB or 5 digits
Absolute Amplitude Accuracy (at $23 \pm 5^\circ\text{C}$, -30 dBm for ATT = 0 dB, or -10 dBm for ATT = 20 dB)	
Freq. \leq 300 MHz	± 1.0 dB
300 MHz < Freq. \leq 500 MHz	± 1.5 dB
Residual responses (excluding line related and CRT scan related component)	
At ATT = 20 dB	-100 dB to input level 0 dBm
At ATT = 0 dB	-100 dB to input level -20 dBm

Ratio Characteristics

Display Range (Ref. value can be set to)	±500 dB
Display Resolution (/div can be set to)	0.001 dB/div to 500 dB/div
Marker Resolution	0.001 dB or 5 digits
Ratio Accuracy (at 23 ± 5°C, the same ATT setting for both input ports -10 dB relative to Input Range)	
Freq. ≤ 100 MHz	±0.5 dB
100 MHz < Freq. ≤ 300 MHz	±1.0 dB
300 MHz < Freq. ≤ 500 MHz	±1.5 dB

Note Frequency response can be corrected by the calibration.



Dynamic Accuracy (At constant temperature within 23±5°C, 20 Hz bandwidth, Freq. ≥ 500 Hz)

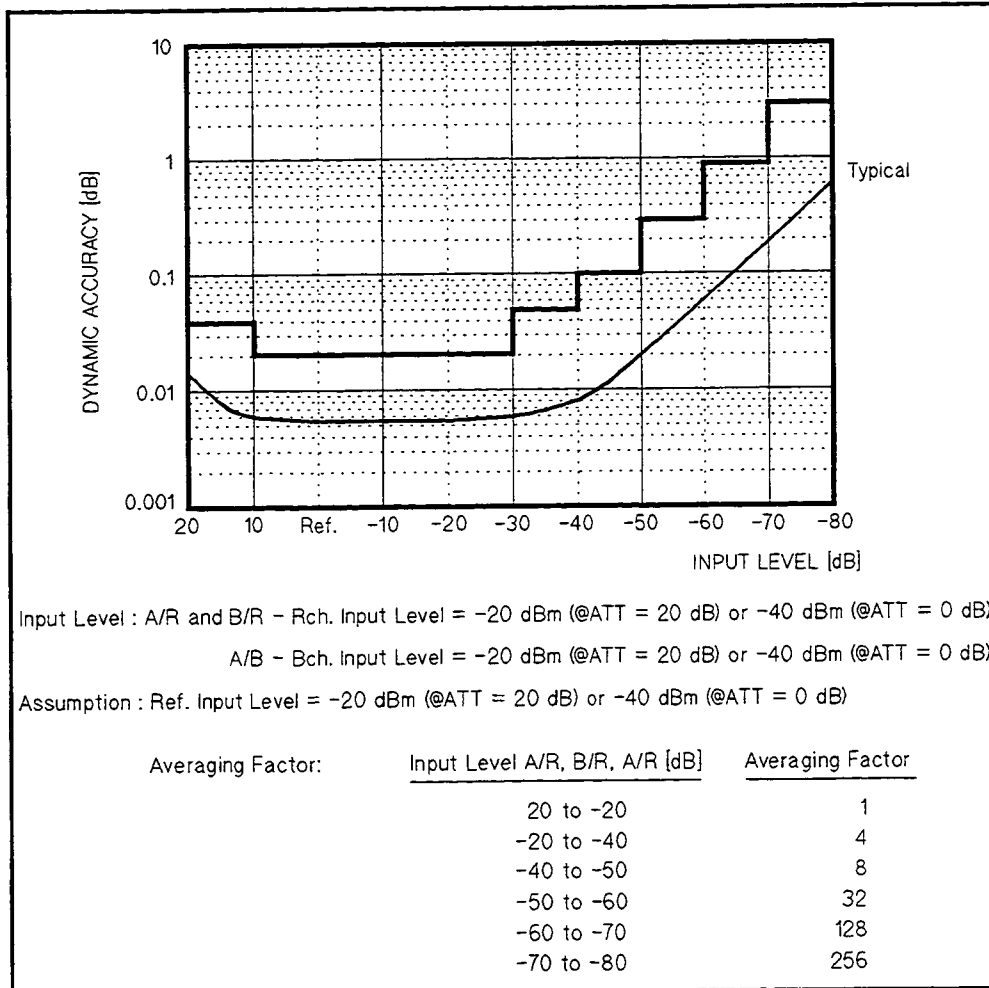

C2102007

Figure 2-2. Dynamic Accuracy (Amplitude)

Specifications

Receiver

Trace Noise (at 1 kHz bandwidth, -10 dB full-scale, Freq. \geq 100 kHz) < 10 mdB rms
Stability 0.02 dB/°C (Typ.)

Phase Characteristics

Measurement Mode Normal/Expanded

Measurement Range

Normal mode ± 100 kdeg (no radian unit available)

Expanded mode ± 5 Mdeg

Display Resolution 10^{-4} deg/div to 10 kdeg/div

Marker Resolution

Normal mode 0.01 deg. or 5 digits

Expanded mode 5 digits

Frequency Response (at $23 \pm 5^\circ\text{C}$, deviation from linear phase, input level -10 dBm (ATT = 20 dB) or -30 dBm (ATT = 0 dB), ATTs are the same setting)

Freq. \leq 100 MHz ± 2.5 degree

100 MHz < Freq. \leq 300 MHz ± 5.0 degree

300 MHz < Freq. \leq 500 MHz ± 10.0 degree

Note

This specification is only for the deviation from linear phase. Frequency response can be corrected by calibration.



Dynamic Accuracy (At constant temperature within $23 \pm 5^\circ\text{C}$, 20 Hz bandwidth, Freq. \geq 500 Hz)

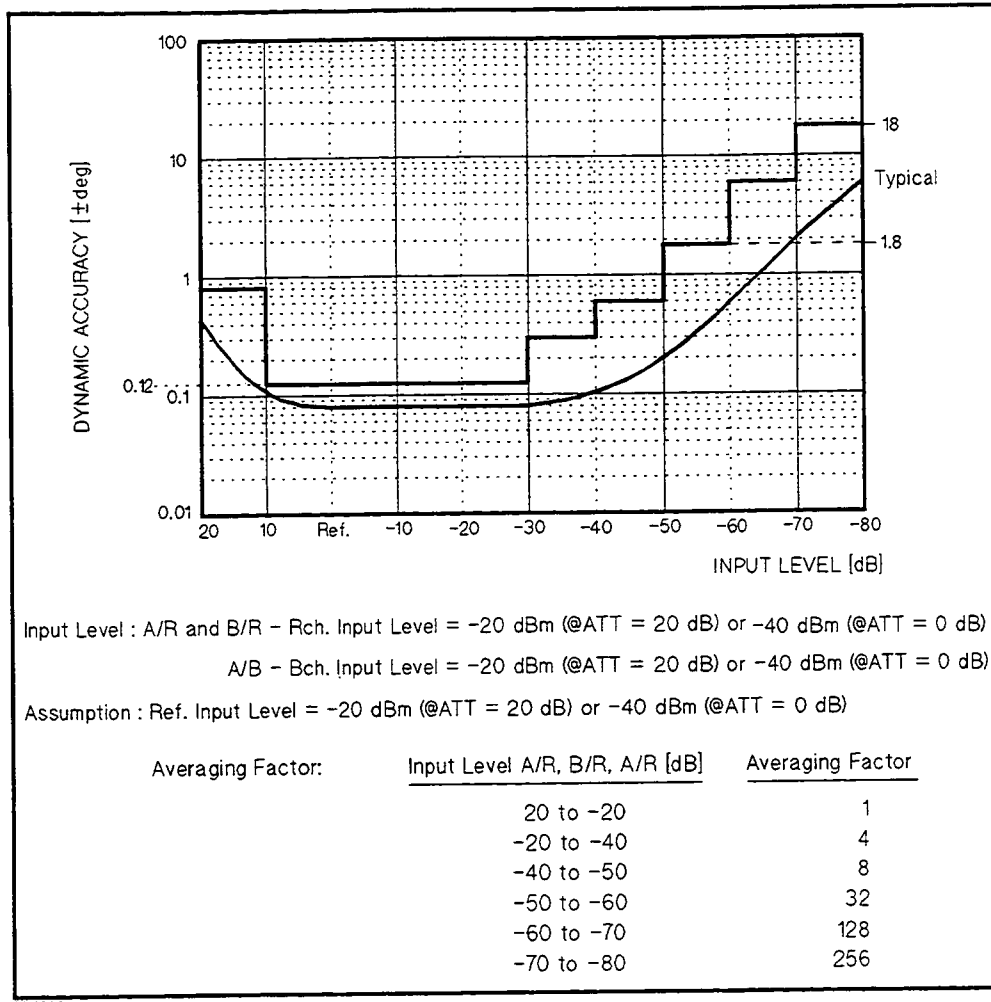

Figure 2-3. Dynamic Accuracy (Phase)

Trace Noise (at Freq. \geq 100 kHz, 1 kHz bandwidth, input level -10 dBm (ATT = 20 dB) or -30 dBm (ATT = 0 dB) 50 mdeg rms
Stability 0.05 deg/ $^\circ\text{C}$ (Typ.)

Delay Characteristics

Aperture Frequency $\frac{200}{N-1}$ % to 100% of span, where N is Number of Points
Display Range (Ref. value can be set to) ± 10 psec to ± 0.5 sec
Display Resolution (/div can be set to) 10 fsec/div to 10 sec/div
Accuracy (at = $23 \pm 5^\circ\text{C}$)

In general, the following formula can be used to determine the accuracy, in seconds, of a specific group delay measurement:

$$\frac{PhaseAccuracy[deg]}{360[deg] \times Aperture[Hz]}$$

Specifications

General Characteristics

Depending on the aperture, input level, and device length, the phase accuracy used in either incremental phase accuracy or worst case phase accuracy.

DC Voltage Measurement Characteristics for INPUT B

Range ± 2 Vdc
 Accuracy ± (0.5 % + 5 mV)
 Damage Level ± 3 Vdc (Typ.)

GENERAL CHARACTERISTICS

Operating Conditions

When disk drive is in operation

Temperature 10 to 50 °C

Humidity (at wet bulb ≤ 29°C, without condensation) 15% ≤ RH ≤ 80%

When disk drive is not in operation

Temperature 0 to 55 °C

Humidity (at wet bulb ≤ 29°C, without condensation) 15% ≤ RH ≤ 95%

Altitude 0 to 4,500 meters (15,000 feet)

Warm Up Time 30 minutes

Non-operating Conditions

Temperature -40 to 60 °C

Humidity (at wet bulb ≤ 29°C, without condensation) 15 % ≤ 95 %

Altitude 0 to 15,240 meters (50,000 feet)

Safety Based on IEC-348, UL 1244 certified by CSA 556B

EMI Based on FTZ 526/527

Probe Power +15 V (300 mA), -12.6 V (160 mA), GND

Line Power

Voltage Selector	Line Voltage	Line Frequency	MAX. VA
115 V	90 to 132 V	47 to 66 Hz	350
230 V	198 to 264 V	47 to 66 Hz	350

Weight 28 kg (Typ.)

Cabinet Dimensions 425(W) × 235(H) × 553(D) mm (Typ.)

REAR PANEL SPECIFICATIONS

I/O Buses

HP-IB Interface

ANSI/IEEE 488.2 compatible. There is no address switch.

S-Parameter Test Set Interface

Figure 2-4 shows pin assignments of the S-parameter test set interface.

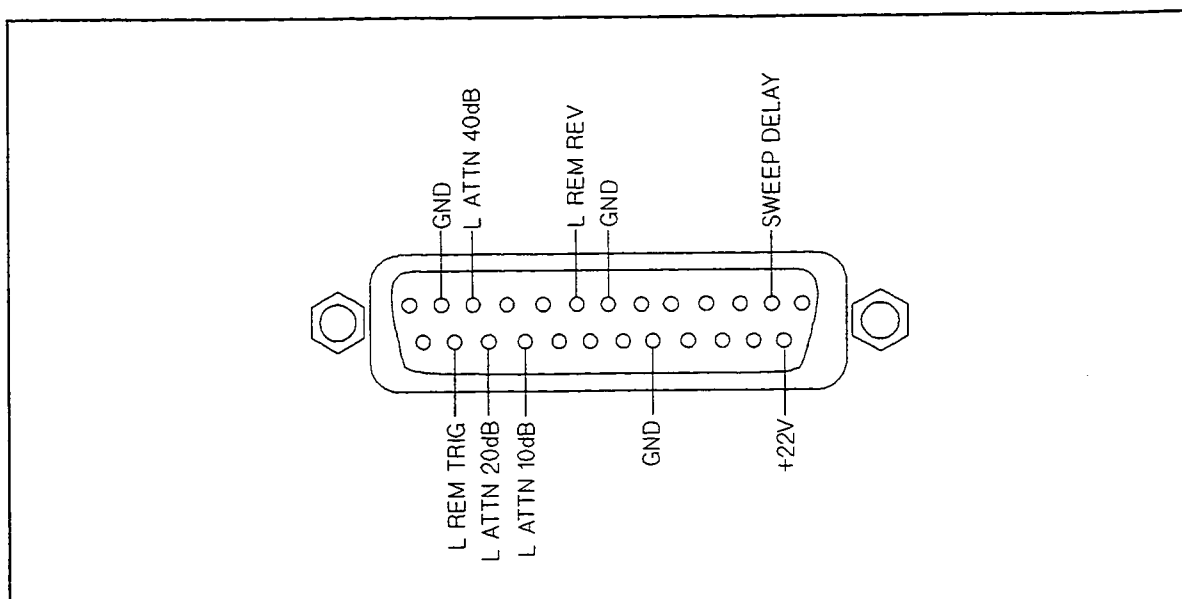

Figure 2-4. S-Parameter Test Set Interface Pin Assignments

The HP part number for the connection cable is 08503-60051.

I/O Port

See Appendix C in the *Reference Manual*.

BNC Connectors

“EXT REF INPUT 10/N MHz” Connector

This inputs a frequency reference to phase lock the analyzer to an external frequency standard.

Applicable input signal is:

Frequency	$\frac{10}{N}$ MHz ± 10 ppm, (N=1,2,5,10)
Amplitude	0 ± 5 dBm
Nominal Impedance	50 Ω

Rear Panel Specifications

“REF OVEN (OPTION 001)” Connector

This outputs a frequency standard if Option 001 is installed. Output signal specifications follow:

Frequency	10 MHz \pm 1.0 ppm
Amplitude	0 \pm 5 dBm
Nominal Impedance	50 Ω

“INT REF OUTPUT” Connector

This outputs a frequency reference to an external instrument to phase lock it to the analyzer.

Output signal specifications follow:

Frequency	10 MHz \pm 20 ppm
Amplitude	0 \pm 5 dBm
Nominal Impedance	50 Ω

“EXT TRIGGER” Connector

This triggers a measurement sweep.

Trigger signal specifications follow (refer to Figure 2-5):

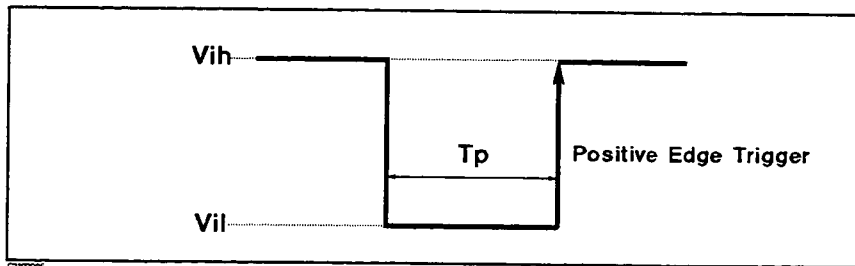

Figure 2-5. Trigger Signal

V_{ih}	+2 V to +5 V
V_{il}	0 V to +0.5 V
Sink current (I_s)	$I_s \leq 0.4$ mA
Pulse width (T_p)	$T_p \geq 20$ μ sec
Trigger Polarity	Positive edge trigger

“EXT PROG RUN/CONT” Connector

This externally triggers RUN/CONT of the Instrument BASIC program. The signal specifications are the same with the “EXT TRIGGER” connector.

“EXT MONITOR” Connectors

These drive an external monitors. The signal specifications follow:

Output level	0 to 0.714 V
H-sync. signal	mixed in “G” signal

FURNISHED ACCESSORIES

Accessory	HP part number	Accessory	HP part number
Operation Manual	08751-90000	BNC Adapter ²	1250-1859
HP-IB Programming Manual	08751-90003	Keyboard Template ³	08751-87111
Using HP Instrument BASIC with the HP 8751A	08751-90004	ASCII Keyboard ³	HP 46021A
Maintenance Manual	08751-90030	ITF Keyboard Cable ³	46020-60001
Floppy Disk	9164-0299	HP Instrument BASIC Manual Set ³	E2083-90000
Power Cable ¹			

1 power cable depends on where the instrument is used, see figure on the next page

2 Only option 001.

3 Only option 002.

Furnished Accessories

<p>OPTION 900 United Kingdom</p>  <p>Plug : BS 1363A, 250V Cable : HP 8120-1351</p>	<p>OPTION 901 Australia / New Zealand</p>  <p>Plug : NZSS 198/AS C112, 250V Cable : HP 8120-1369</p>
<p>OPTION 902 European Continent</p>  <p>Plug : CEE-VII, 250V Cable : HP 8120-1689</p>	<p>OPTION 903 U.S. / Canada</p>  <p>Plug : NEMA 5-15P, 125V, 15A Cable : HP 8120-1378</p>
<p>OPTION 904 U.S. / Canada</p>  <p>Plug : NEMA 6-15P, 250V, 15A Cable : HP 8120-0698</p>	<p>OPTION 905* Any country</p>  <p>Plug : CEE 22-VI, 250V Cable : HP 8123-1396</p>
<p>OPTION 906 Switzerland</p>  <p>Plug : SEV 1011.1959-24507 Type 12, 250V Cable : HP 8120-2104</p>	<p>OPTION 912 Denmark</p>  <p>Plug : DHCR 107, 220V Cable : HP 8120-2956</p>
<p>OPTION 917 India / Republic of S.Africa</p>  <p>Plug : SABS 164, 250V Cable : HP 8120-4211</p>	<p>OPTION 918 Japan</p>  <p>Plug : JIS C 8303, 125V, 15A Cable : HP 8120-4753</p>
<p>NOTE: Each option number includes a 'family' of cords and connectors of various materials and plug body configurations (straight, 90° etc.).</p> <p>* Plug option 905 is frequently used for interconnecting system components and peripherals.</p>	

Figure 2-6. Power Cables Supplied

TYPICAL SYSTEM PERFORMANCE

Introduction

The performance of a network analyzer system depends not only on the performance of the individual instruments, but also on the system configuration, the user-selected operating conditions, and the measurement calibration.

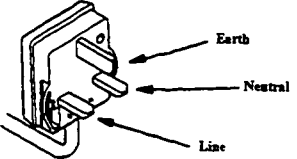
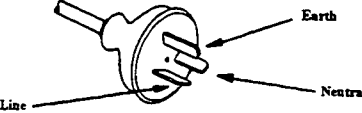
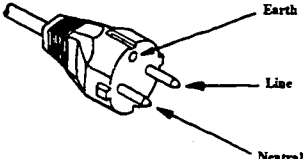
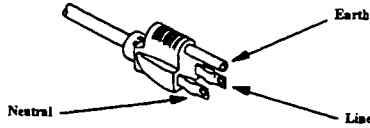
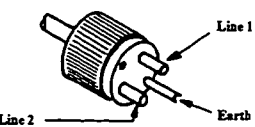
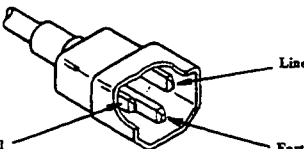
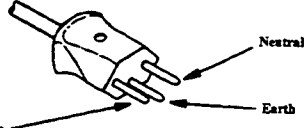
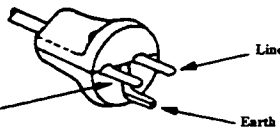
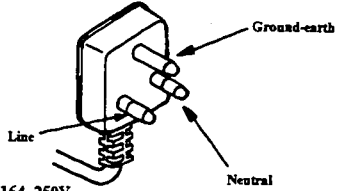
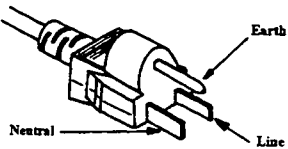
This section explains the residual errors remaining in a measurement system after accuracy enhancement. It provides the information needed to calculate the total measurement uncertainty of different systems. Graphs at the beginning of the section show examples of the performance that can be calculated using the methods in this section.

The sources of measurement errors are explained, with an error model flowgraph and uncertainty equations. Information is provided for conversion of the dynamic accuracy error (in dB) to a linear value for use in the uncertainty equations. The effects of temperature drift on measurement uncertainty are illustrated with graphs.

Procedure and blank worksheets are supplied to compute the total error-corrected measurement uncertainty of a system. These procedures combine the terms in the tables, the uncertainty equation, and the nominal S-parameter data of the device under test.

Comparison Of Typical Error-Corrected Measurement Uncertainty

Figure 2-7 through Figure 2-14 are examples of the measurement uncertainty data that can be calculated using the information provided in this section. These figures compare the reflection and transmission measurement uncertainty of a 7 mm system using different levels of error correction. Each figure shows uncorrected values and residual uncertainty values after full two port calibration. The data applies to a frequency range of 100 kHz to 500 MHz with a stable temperature (no temperature drift), using compatible 7 mm calibration devices from the HP 85031B calibration kit, and setting the attenuators in input port A and B of the HP 8751A to 20 dB.

The results graphed in Figure 2-7 through Figure 2-14 can be obtained using the HP 87511A. Different measurement calibration procedures provide comparable measurement improvement or the following compatible connector types and test sets (using the compatible calibration kits):

- HP 87511A with Option 001 50 Ω type-N connectors
- HP 87511B 75 Ω type-N connectors

Typical System Performance

Reflection Uncertainty of a One-Port Device

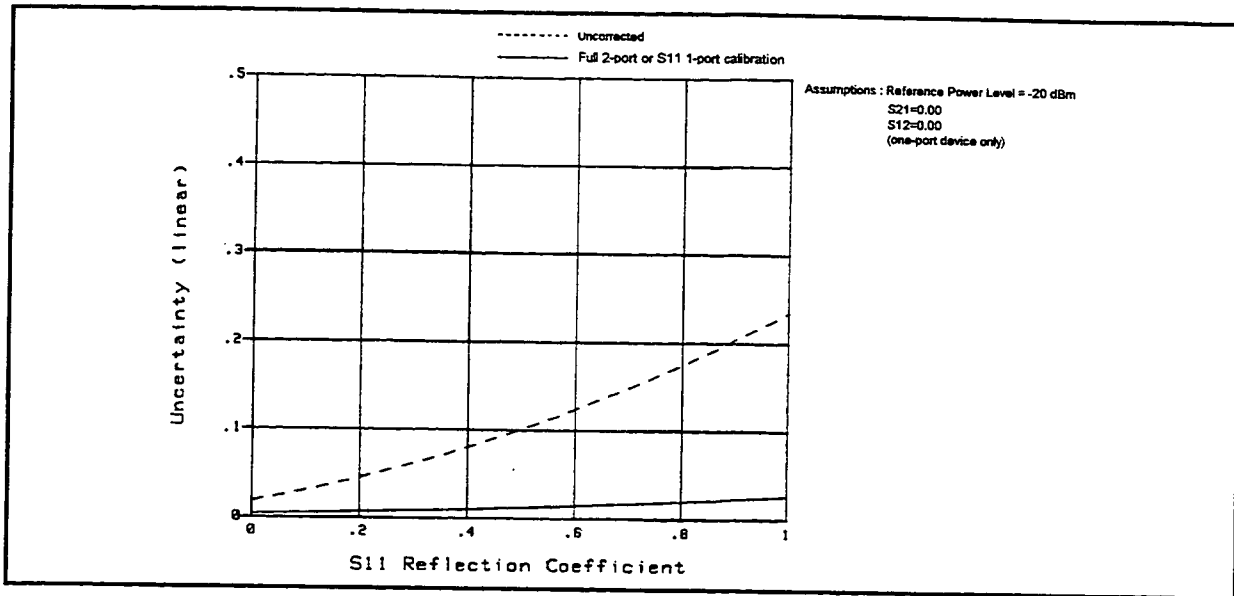

Figure 2-7. Total Reflection Magnitude Uncertainty

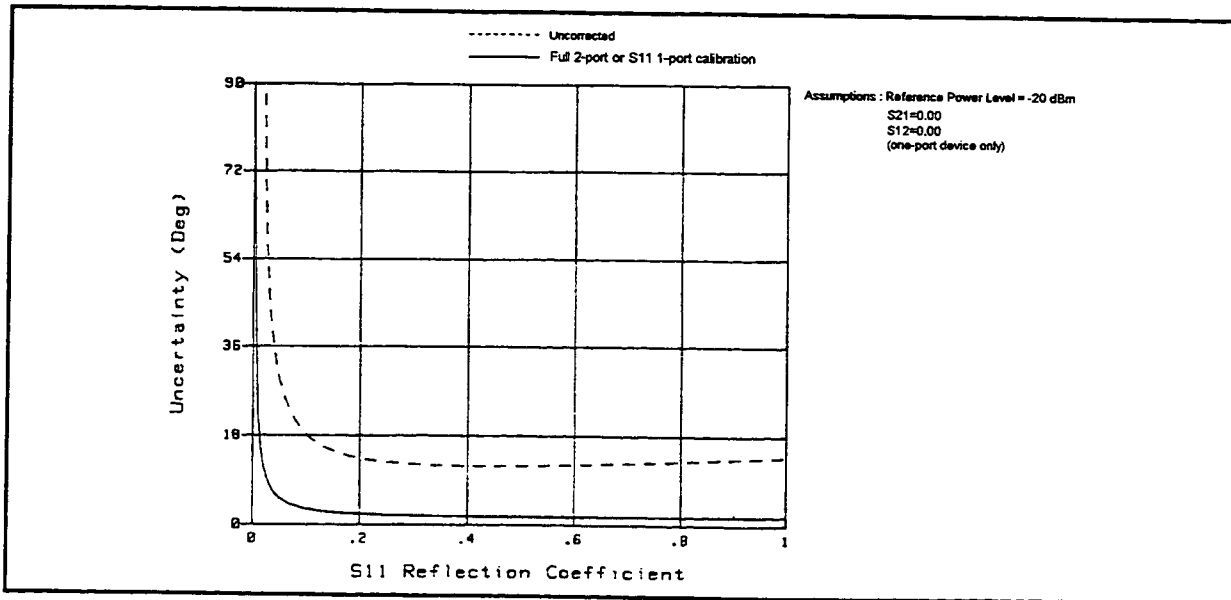

Figure 2-8. Total Reflection Phase Uncertainty

Reflection Uncertainty of a Two-Port Device

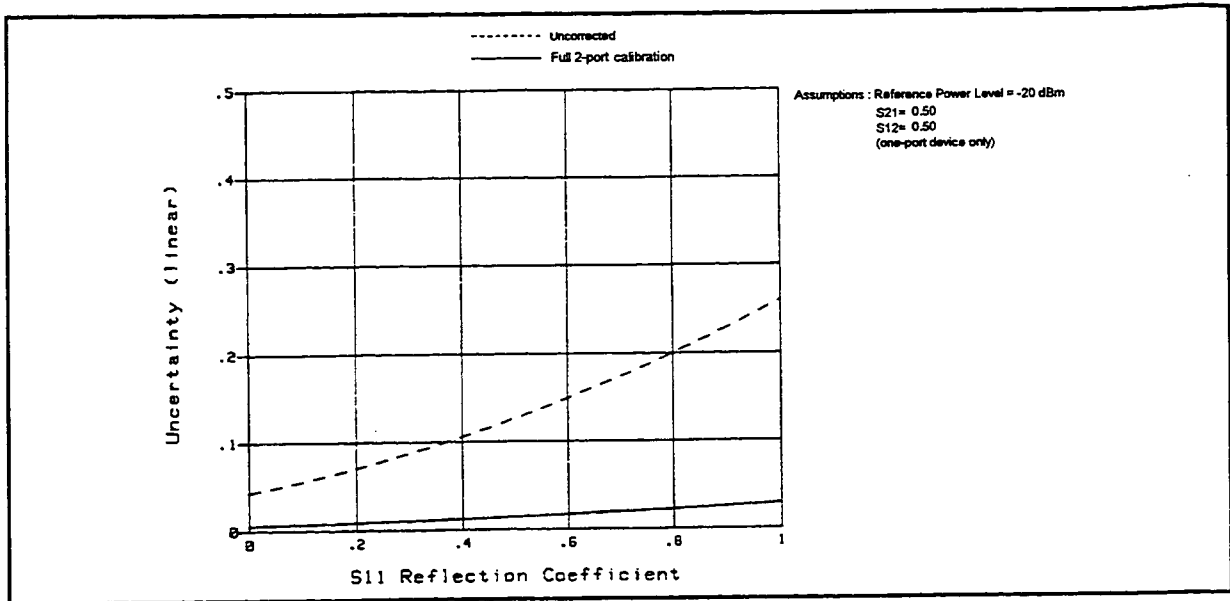

Figure 2-9. Total Reflections Magnitude Uncertainty

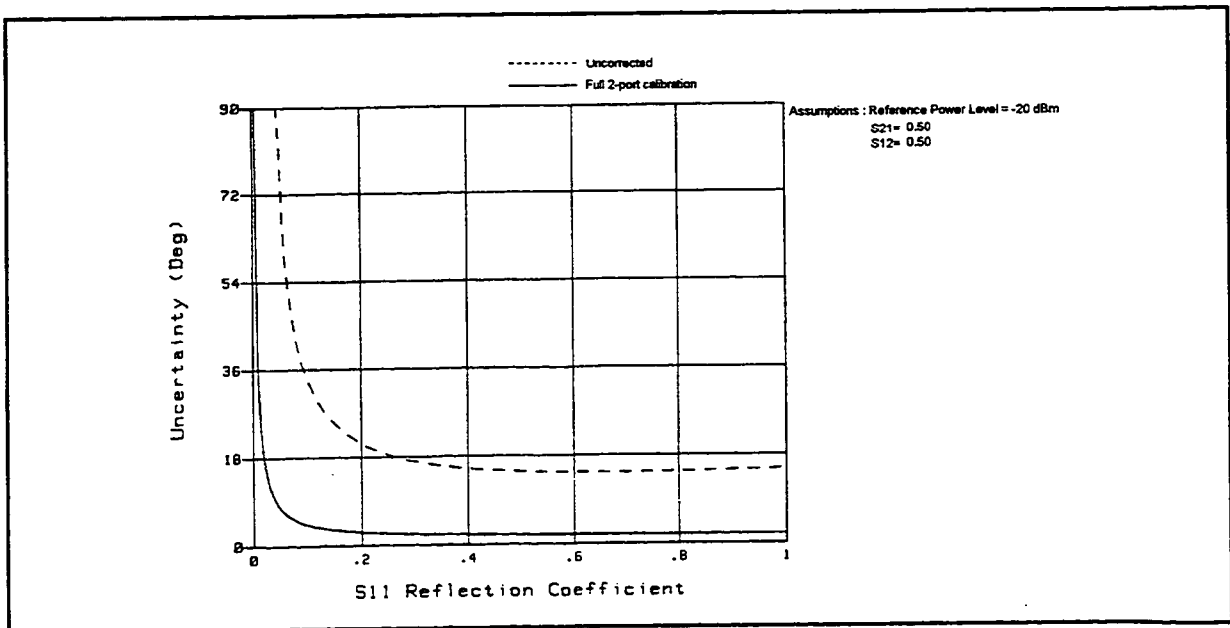

Figure 2-10. Total Reflection Phase Uncertainty

Specifications

Typical System Performance

Transmission Uncertainty of a Low-Loss Device

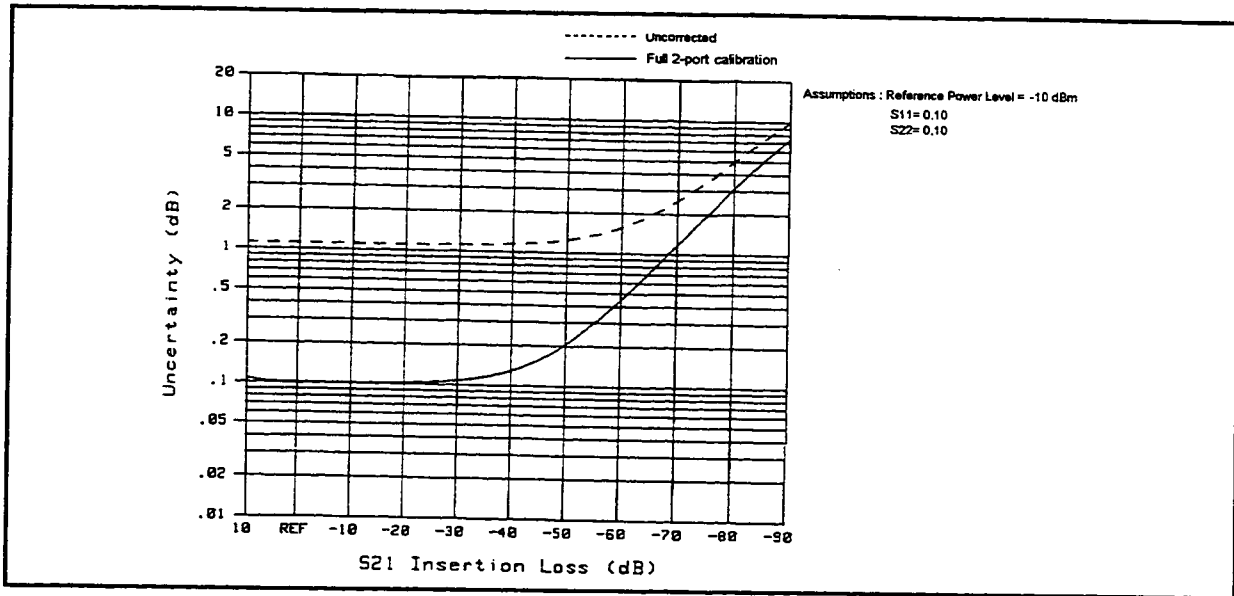

Figure 2-11. Total Transmission Magnitude Uncertainty

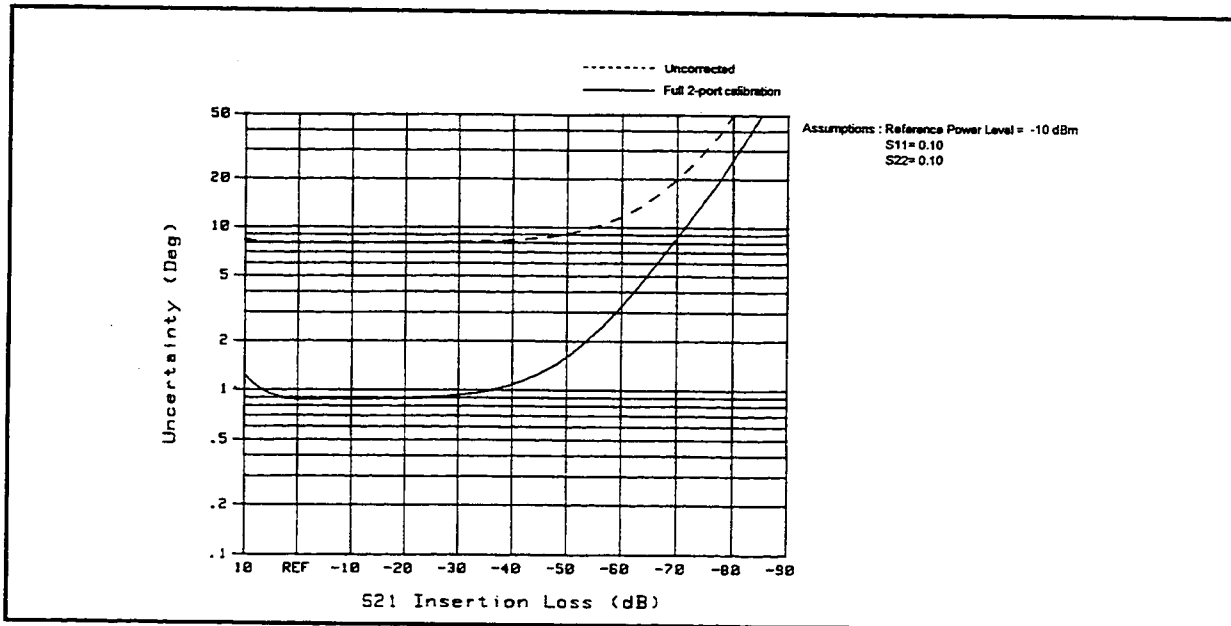

Figure 2-12. Total Transmission Phase Uncertainty

Transmission Uncertainty of a Wide Dynamic Range Device

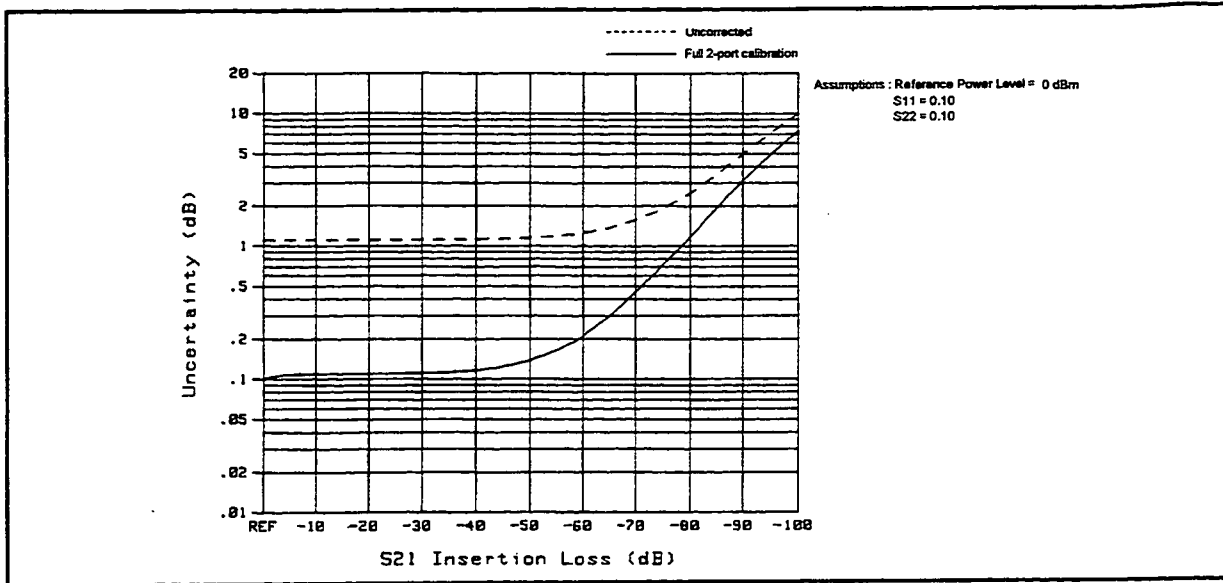

Figure 2-13. Total Transmission Magnitude Uncertainty

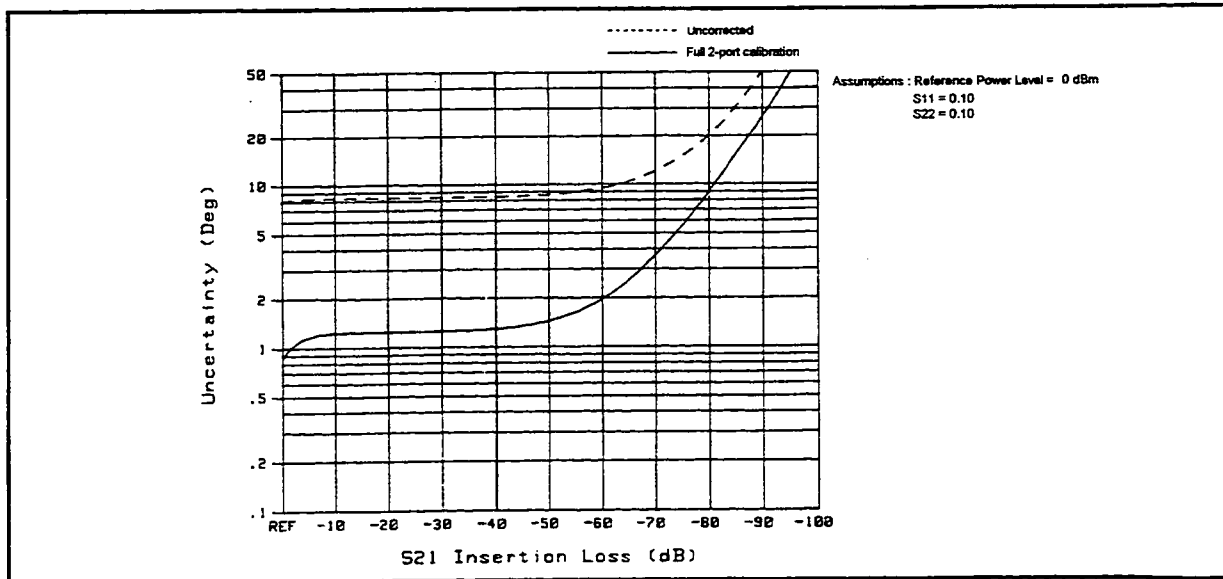

Figure 2-14. Total Transmission Phase Uncertainty

Specifications

TYPES OF RESIDUAL MEASUREMENT ERRORS

Network analysis measurement errors can be separated into three types: systematic, random, and drift errors. Measurement errors that remain after measurement calibration are called residual measurement errors. See "Measurement Calibration" in the *Reference Manual*, for a detailed description of the systematic errors corrected by measurement calibration.

Residual Systematic Errors

These errors result from imperfections in the calibration standards, connector standards and interface, interconnecting cables, and instrumentation. These are the errors that affect transmission and reflection measurements.

Transmission Measurements	Reflection Measurements
Dynamic Accuracy Effective Switch port match Switch tracking Frequency error	
Effective crosstalk Effective load match Effective transmission tracking Cable stability	Effective directivity Effective source match Effective reflection tracking

Residual Random Errors

These non-repeatable errors are due to trace noise, noise floor, and connector repeatability. They affect both transmission and reflection measurements.

Residual Drift Errors

These errors stem from frequency drift and instrumentation drift. They affect both kinds of measurements. Instrumentation drift is primarily temperature related.

SYSTEM ERROR MODE

Any measurement result is the vector sum of the actual test device response plus all error terms. The precise effect of each error term depends upon its magnitude and phase relationship to the actual test device response. When the phase of an error response is not known, phase is assumed to be worst case (0 or 180 degrees). Random errors such as noise and connector repeatability are generally combined in a root-sum-of-the squares (RSS) manner. The error term related to thermal drift is combined on a worst-case basis as shown in each uncertainty equation given in the following paragraphs.

Figure 2-15 shows the error model for the analyzer with the HP 87511A,B S-parameter test set. This error model shows the relationship of the various error sources in the forward direction, and may be used to analyze overall measurement performance. The model for signal flow in the reverse direction is similar. Note the appearance of the dynamic accuracy, noise errors, switch errors, and connector repeatability terms in both the reflection and transmission portions of the model.

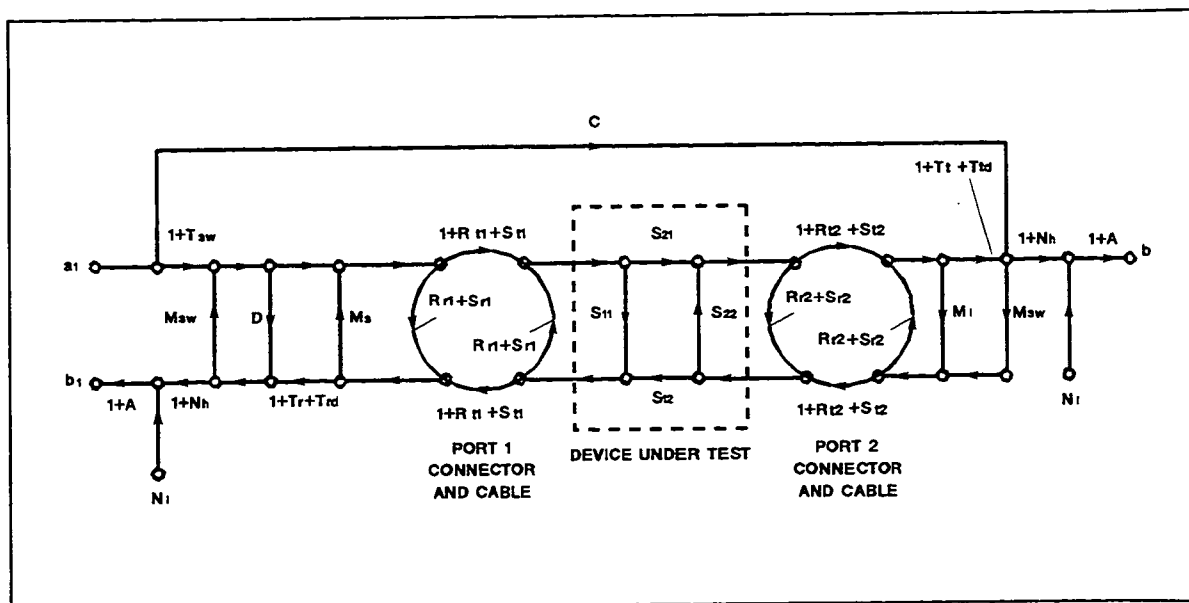

Figure 2-15. HP 8751A/87511A System Error Model

Specifications

System Error Mode

Table 2-1. Parameters of System Error Model

A	= Dynamic Accuracy (A_m = Magnitude Dynamic Accuracy) (A_p = Phase Dynamic Accuracy)	D	= Residual Directivity
N₁	= Noise Floor	M_s	= Residual Source Match
N_h	= High Level Noise	M_l	= Residual Load Match
T_{sw}	= Switch Tracking	C	= Residual Crosstalk
M_{sw}	= Switch Port Match	T_r	= Residual Reflection Tracking
R_{r1}	= Port 1 Reflection Repeatability	T_t	= Residual Transmission Tracking
R_{r2}	= Port 2 Reflection Repeatability	S_{r1}	= Port 1 Cable Reflection Stability
R_{t1}	= Port 1 Transmission Repeatability	S_{r2}	= Port 2 Cable Reflection Stability
R_{t2}	= Port 2 Transmission Repeatability	S_{t1}	= Port 1 Cable Transmission Stability
T_{rd}	= Reflection Tracking Drift	S_{t2}	= Port 2 Cable Transmission Stability
T_{td}	= Transmission Tracking Drift		

For measurement of one-port devices, set the crosstalk (**C**), load match (**M_l**), transmission tracking (**T_t**), port 2 connector repeatability (**R_{r2}**, **R_{t2}**), and port 2 cable stability (**S_{r2}**, **S_{t2}**) error terms to zero.

REFLECTION UNCERTAINTY EQUATIONS

Total Reflection Magnitude Uncertainty (E_{rm})

An analysis of the error model yields an equation for the reflection magnitude uncertainty. The equation contains all of the first order terms and the significant second order terms. The error term related to thermal drift is combined on a worst case basis with the total of systematic and random errors. The four terms under the radical are random in character and are combined on an RSS basis. The terms in the systematic error group are combined on a worst case basis. In all cases, the error terms and the S-parameters are treated as linear absolute magnitudes.

$$E_{rm(\text{linear})} = V_r + S_{11} T_{rd(\text{magnitude})}$$

and

$$E_{rm(\text{log})} = 20 \log \left(1 \pm \frac{E_{rm}}{S_{11}} \right)$$

where

$$V_r = S_r + \sqrt{W_r^2 + X_r^2 + Y_r^2 + Z_r^2}$$

S_r = systematic error

$$= (1 + T_{sw})(D + S_{r1}) + (T_{sw} + T_r)S_{11} + (M_{sw} + M_s + S_{r1})S_{11}^2 + M_1 S_{21} S_{12} + A_m S_{11}$$

W_r = random low-level noise

$$= 3N_l$$

X_r = random high-level noise

$$= 3N_h S_{11}$$

Y_r = random port1 repeatability

$$= R_{r1} + 2R_{t1} S_{11} + R_{r1} S_{11}^2$$

Z_r = random port2 repeatability

$$= R_{r2} S_{21} S_{12}$$

Total Reflection Phase Uncertainty (E_{rp})

Reflection phase uncertainty is determined from a comparison of the magnitude uncertainty with the test signal magnitude. The worst case phase angle is computed. This result is combined with the error terms related to thermal drift of the total system, port 1 cable stability, and phase dynamic accuracy.

$$E_{rp} = \arcsin \left(\frac{V_r - A_m S_{11}}{S_{11}} \right) + T_{rd(\text{phase})} + 2S_{t1} + A_p$$

TRANSMISSION UNCERTAINTY EQUATIONS

Total Transmission Magnitude Uncertainty (E_{tm})

An analysis of the error model in Figure 2-15 yields an equation for the transmission magnitude uncertainty. The equation contains all of the first order terms and some of the significant second order terms. The error term related to thermal drift is combined on a worst case basis with the total of systematic and random errors. The four terms under the radical are random in character and are combined on an RSS basis. The terms in the systematic error group are combined on a worst case basis. In all cases, the error terms are treated as linear absolute magnitudes.

$$E_{tm(\text{linear})} = V_t + S_{21} T_{td(\text{magnitude})}$$

and

$$E_{tm(\text{log})} = 20 \log \left(1 \pm \frac{E_{tm}}{S_{21}} \right)$$

where

$$V_t = S_t + \sqrt{W_t^2 + X_t^2 + Y_t^2 + Z_t^2}$$

S_t = systematic error

$$= C + (T_{sw} + T_t)S_{21} + (M_{sw} + M_s + S_{r1})S_{11}S_{21} + (M_{sw} + M_1 + S_{r2})S_{21}S_{22} + A_m S_{21}$$

W_t = random low-level noise

$$= 3N_l$$

X_t = random high-level noise

$$= 3N_h S_{21}$$

Y_t = random port1 repeatability

$$= R_{t1} S_{21} + R_{r1} S_{11} S_{21}$$

Z_t = random port2 repeatability

$$= R_{t2} S_{21} + R_{r2} S_{22} S_{21}$$

Total Transmission Phase Uncertainty (E_{tp})

Transmission phase uncertainty is calculated from a comparison of the magnitude uncertainty with the test signal magnitude. The worst case phase angle is computed. This result is combined with the error terms related to phase dynamic accuracy, cable phase stability, and thermal drift of the total system.

$$E_{tp} = \arcsin \left(\frac{V_t - A_m S_{21}}{S_{21}} \right) + T_{td(\text{phase})} + S_{t1} + S_{t2} + A_p$$

DYNAMIC ACCURACY

The dynamic accuracy value used in the system uncertainty equations is obtained for the analyzer's dynamic accuracy specifications. The specification for magnitude dynamic accuracy is in dB, and it must be converted to a linear value to be used in the UNCERTAINTY equations. In addition, the HP 8751A's dynamic accuracy specifications are given for an absolute input signal in dBm, and must be converted to a relative error (relative to the power at which the measurement calibration occurs) to be used in the system uncertainty equations.

$$\text{Dynamic Accuracy (linear)} = 10^{\frac{\pm \text{DynAcc(dB)}}{20}} \mp 1$$

$$\text{Dynamic Accuracy (dB)} = 20 \log(1 \pm \text{Dynamic Accuracy (linear)})$$

Definitions

P_{cal} = the calibration (thus the reference) power level at the instrument input port (A or B) (i.e. when the short is measured in a reflection calibration OR when the thru is measured in a transmission calibration)

P_{meas} = the measured input signal (dBm) when the DUT is measured

Residual dynamic accuracy = the residual error remaining when P_{meas} is equal to P_{cal}

Linacc = relative dynamic accuracy (linear magnitude or phase) for the ratioed measurement used in the linear system performance calculation

Lincal = dynamic accuracy (linear magnitude or phase) term for single input at P_{cal}

Linmeas = dynamic accuracy (linear magnitude or phase) term for single input at P_{meas}

Determining Relative Dynamic Accuracy Error Contribution

The example given here shows how to determine the relative dynamic accuracy error contribution to a measurement in a ratio mode. Six example graphs are provided: Figure 2-16 and Figure 2-17 show the worst-case magnitude and phase dynamic accuracy error with a reference power level of 0 dBm, Figure 2-18 and Figure 2-19 with a reference power level of -20 dBm, and Figure 2-20 and Figure 2-21 with a reference power level of -60 dBm.

Table 2-2 shows the equations used to determine the relative dynamic accuracy error contribution, when assuming the R channel input power level is constant during calibration and when measuring a DUT.

Table 2-2. Determining Relative Dynamic Accuracy (Linacc)

P _{cal}	0 dBm ≥ P _{cal} ≥ -40 dBm		-40 dBm > P _{cal} > -100 dBm
P _{meas}	0 dBm ≥ P _{meas} ≥ -40 dBm	-40 dBm ≥ P _{meas} ≥ -100 dBm	0 dBm ≥ P _{meas} ≥ -100 dBm
Linacc	ABS(Lincal - Linmeas) + Residual ^{1,2}	Lincal + Linmeas - Residual ^{1,2}	Lincal + Linmeas

1 Residual Magnitude Dynamic Accuracy (linear) = 0.000645

2 Residual Phase Dynamic Accuracy = 0.08°

Dynamic Accuracy

Dynamic Accuracy Error Contribution

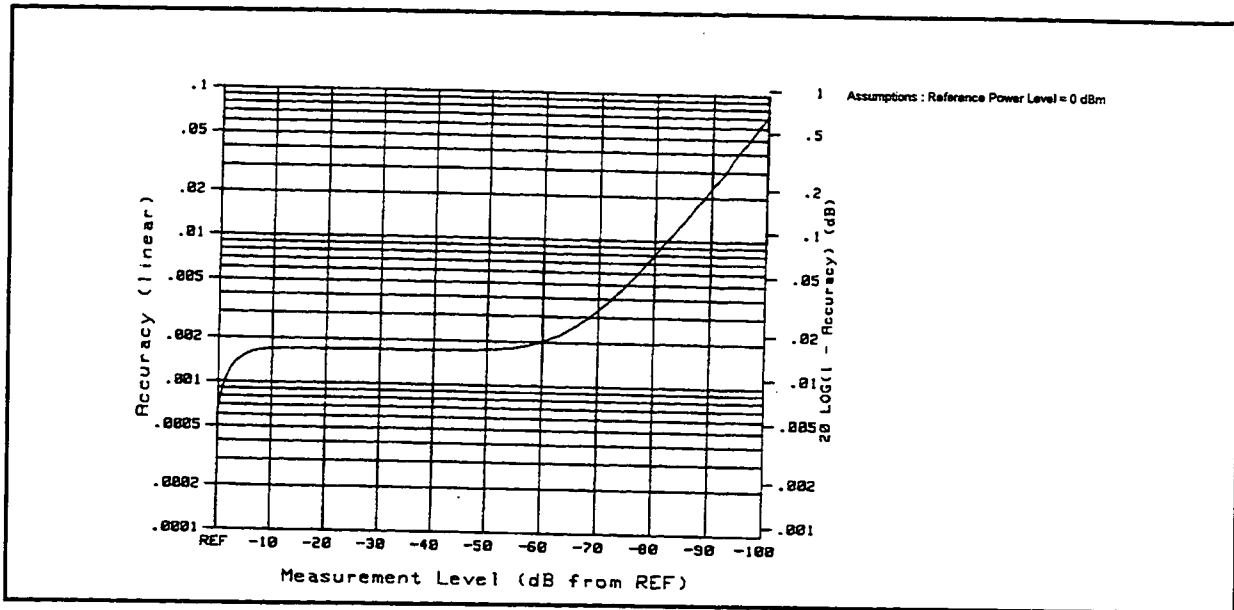

Figure 2-16. Worst-Case Magnitude Dynamic Accuracy Error

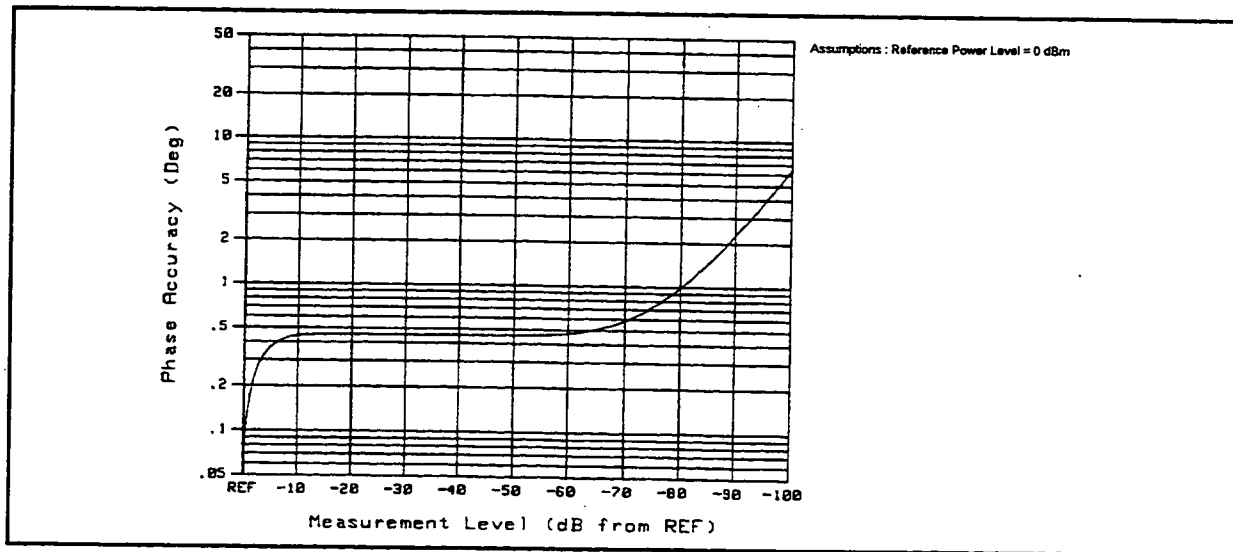

Figure 2-17. Worst-Case Phase Dynamic Accuracy Error

Dynamic Accuracy Error Contribution

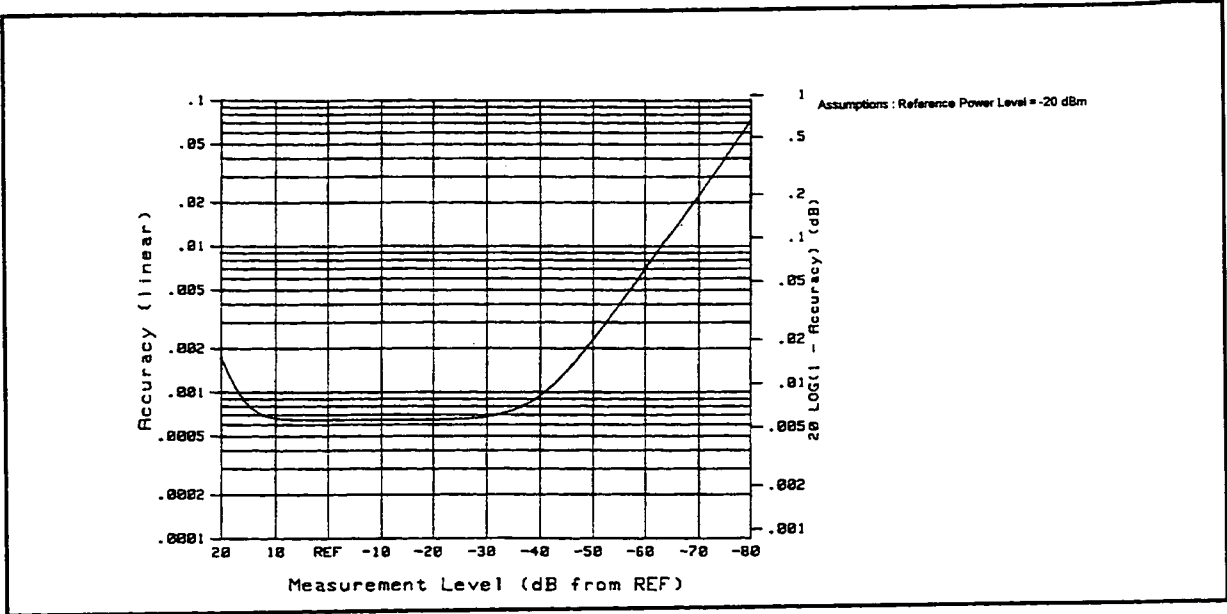

Figure 2-18. Worst-Case Magnitude Dynamic Accuracy Error

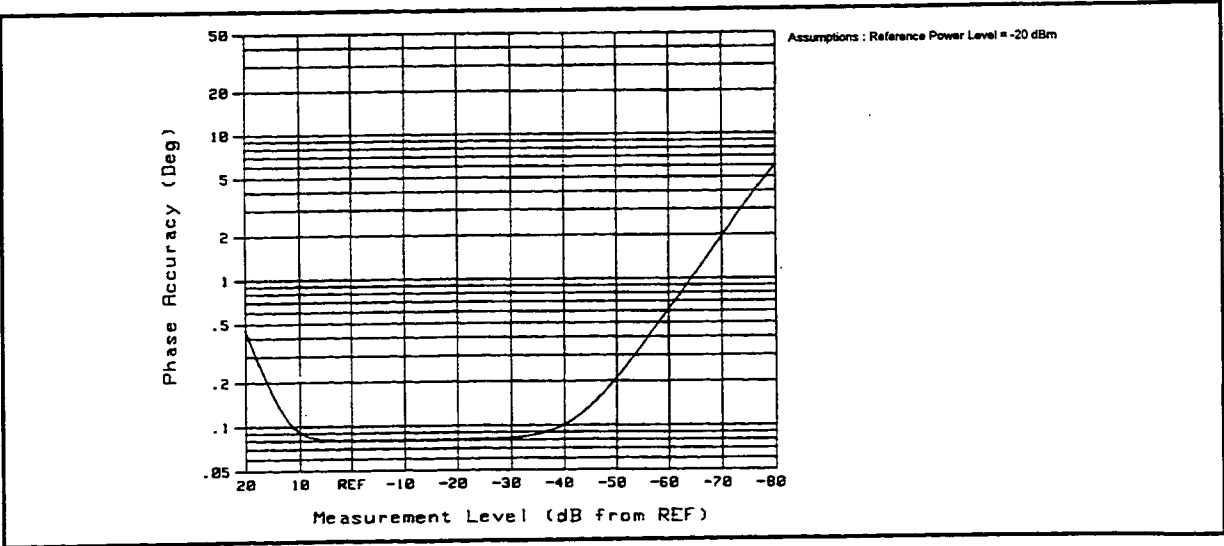

Figure 2-19. Worst-Case Phase Dynamic Accuracy Error

Specifications

Dynamic Accuracy

Dynamic Accuracy Error Contribution

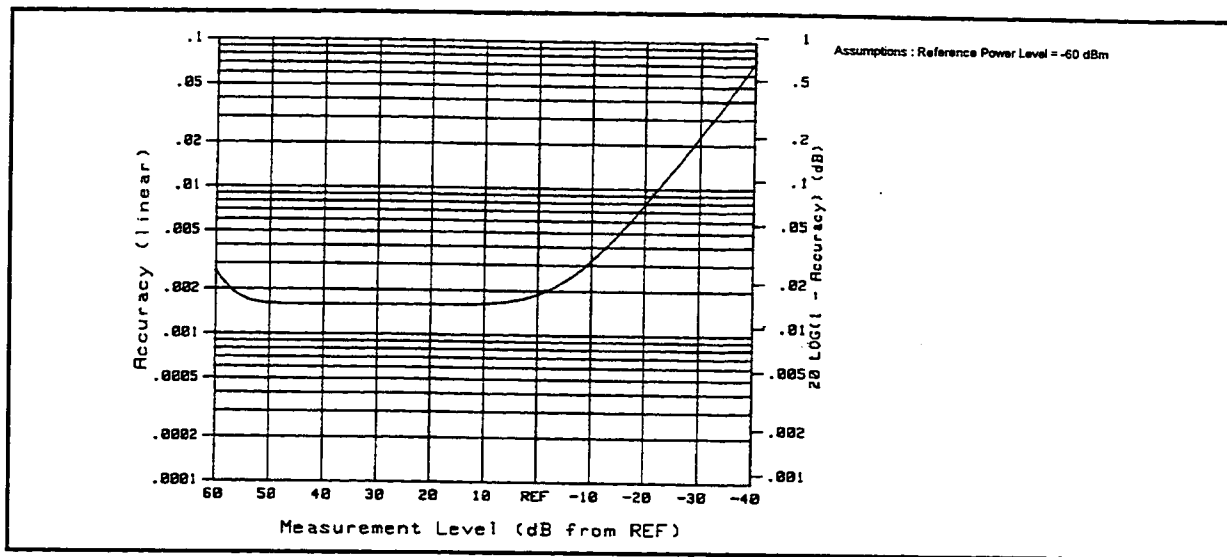

Figure 2-20. Worst-Case Magnitude Dynamic Accuracy Error

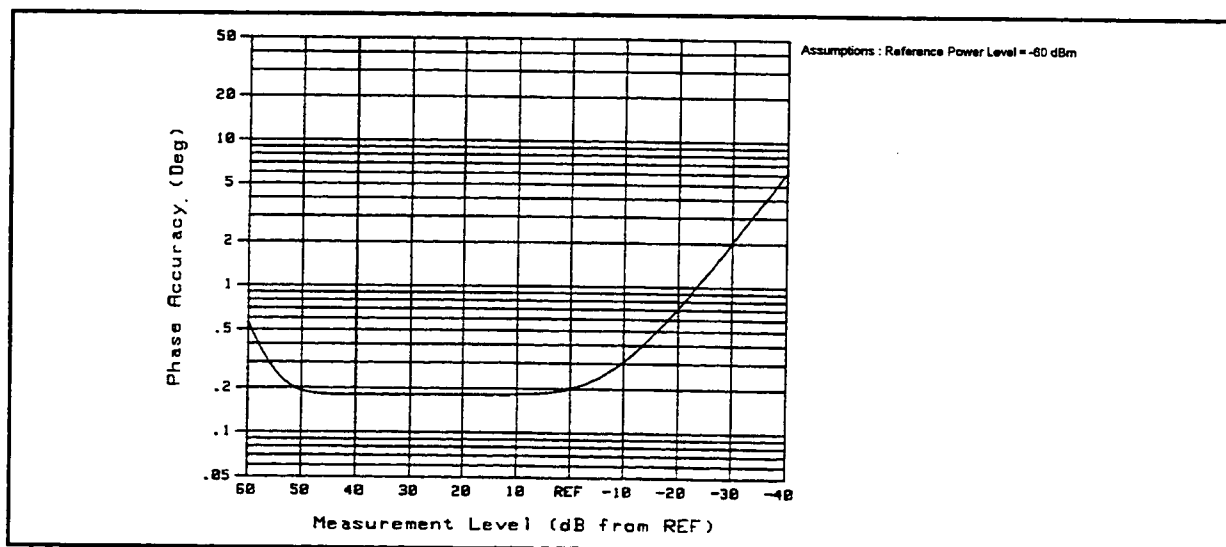

Figure 2-21. Worst-Case Phase Dynamic Accuracy Error

EFFECTS OF TEMPERATURE DRIFT

Figure 2-22 to Figure 2-25 are graphs showing the effects of temperature drift on error-corrected measurement uncertainty values. Values are shown for changes of $\pm 1^\circ\text{C}$, $\pm 3^\circ\text{C}$ and $\pm 5^\circ\text{C}$ from the ambient temperature. Figure 2-22 and Figure 2-23 show total reflection magnitude and phase uncertainty with temperature drift following an S_{11} one-port calibration. Figure 2-24 and Figure 2-25 show total transmission magnitude and phase uncertainty with temperature drift following a full two-port error correction. The graphs apply to measurements up to 500 MHz.

Effects of Temperature Drift

Temperature Drift with S_{11} One-Port Calibration

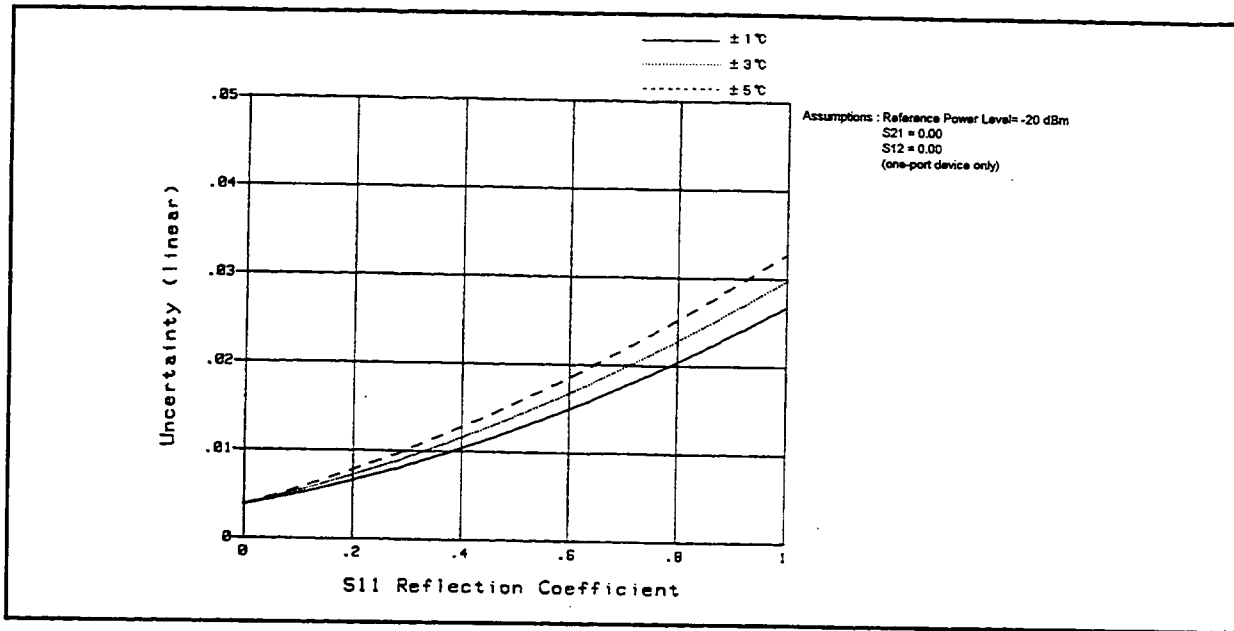

Figure 2-22. Total Reflection Magnitude Uncertainty

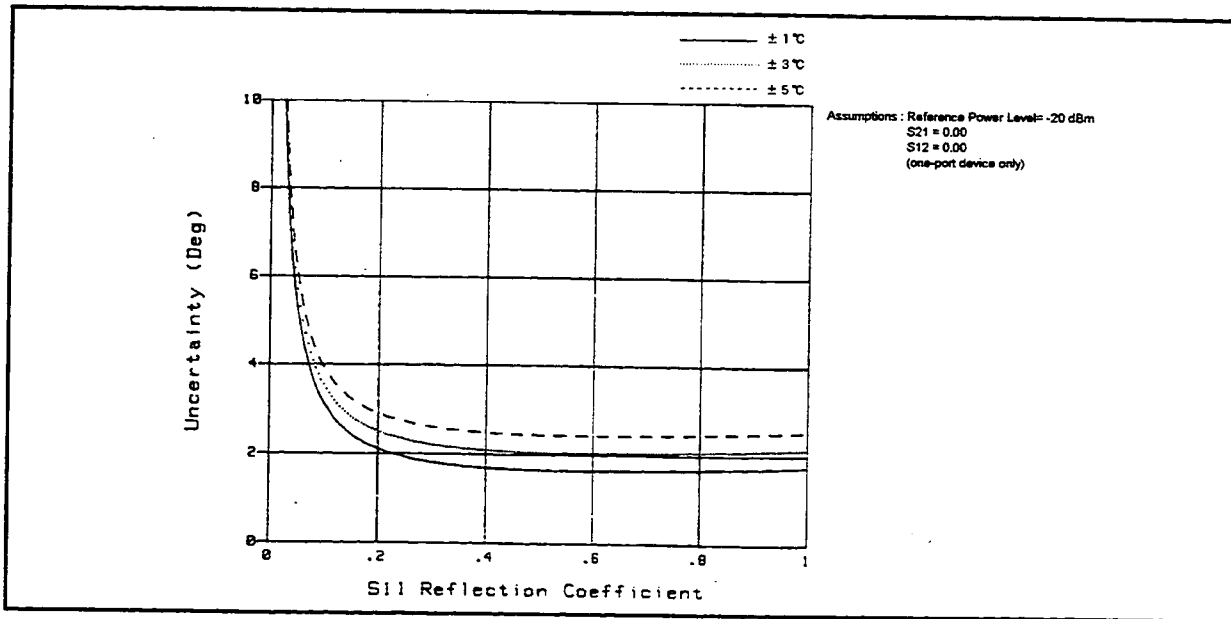

Figure 2-23. Total Reflection Phase Uncertainty

Temperature Drift with Full Two-Port Calibration

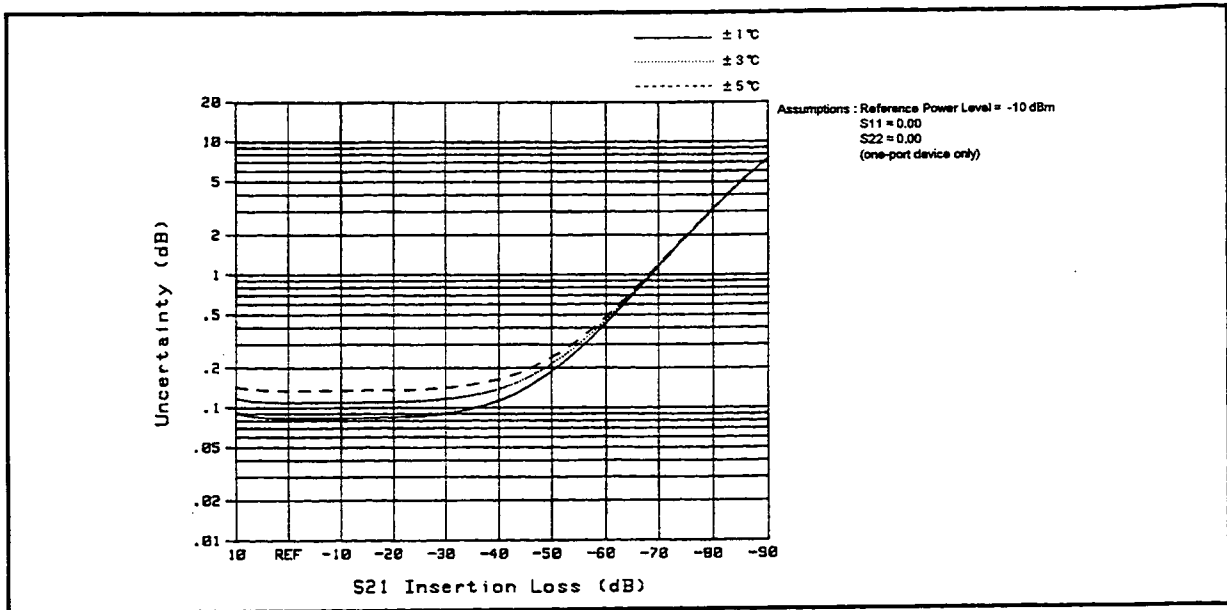

Figure 2-24. Total Transmission Magnitude Uncertainty

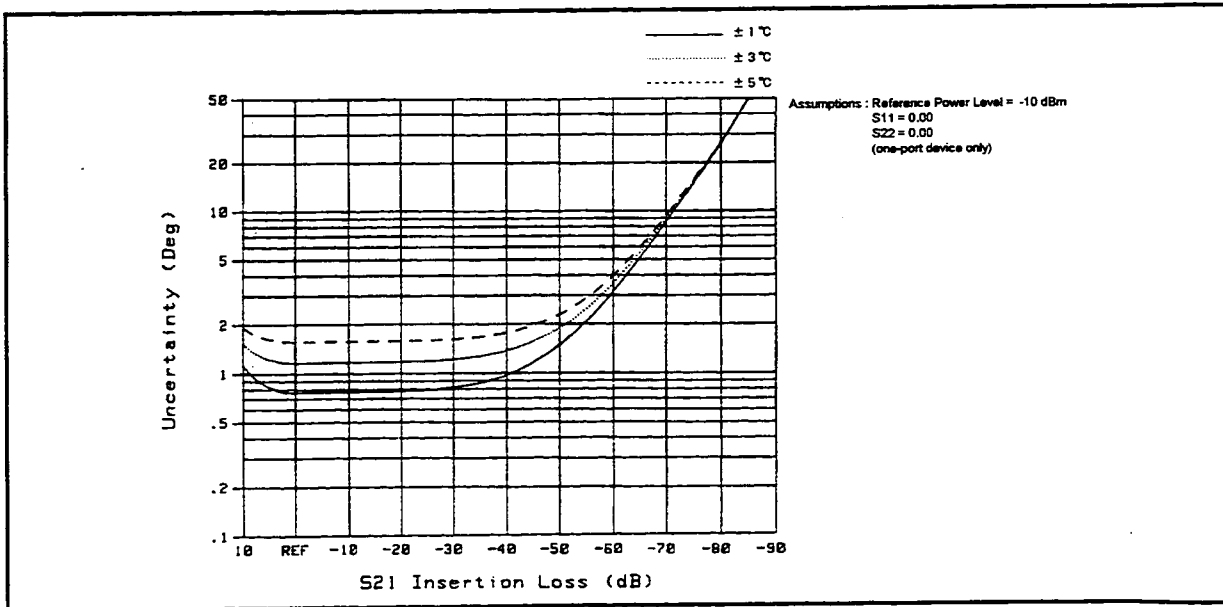

Figure 2-25. Total Transmission Phase Uncertainty

Specifications

SYSTEM PERFORMANCE WITH DIFFERENT TEST SETS AND CONNECTOR TYPES

The Tables in the following pages provides typical system performance for HP 8751A systems using different test sets and different connector types. The values listed are for uncorrected measurements and for corrected measurements after measurement calibration. The linear value is shown in parenthesis under the dB value. The following tables provide specifications for systems of the HP 8751A with HP 87511A,B.

Table 2-3. Typical System Performance for Devices

Symbol	Error Terms	7 mm ^{1,2}		50 Ω Type N ^{2,3}		75 Ω Type N ^{2,4}	
		Uncorrected	Full two port	Uncorrected	Full two port	Uncorrected	Full two port
D	Directivity	-35 dB ⁵ (1.78×10 ⁻²)	-50 dB ⁵ (3.16×10 ⁻³)	-35 dB ⁵ (1.78×10 ⁻²)	-47 dB ⁵ (4.47×10 ⁻³)	-33 dB ⁵ (2.24×10 ⁻²)	-44 dB ⁵ (6.31×10 ⁻³)
M _s	Source Match	-20 dB (0.1)	-40 dB (0.01)	-20 dB (0.1)	-35 dB (1.78×10 ⁻²)	-20 dB (0.1)	-35 dB (1.78×10 ⁻²)
T _r	Reflection Tracking	±1.0 dB (1.22×10 ⁻¹)	±0.05 dB (5.77×10 ⁻³)	±1.0 dB (1.22×10 ⁻¹)	±0.06 dB (6.93×10 ⁻³)	±1.0 dB (1.22×10 ⁻¹)	±0.06 dB (6.93×10 ⁻³)
M _l	Load Match	-20 dB (0.1)	-42 dB (7.94×10 ⁻³)	-20 dB (0.1)	-35 dB (1.78×10 ⁻²)	-20 dB (0.1)	-35 dB (1.78×10 ⁻²)
T _t	Trans. Tracking	±1.0 dB (1.22×10 ⁻¹)	±0.03 dB (3.46×10 ⁻³)	±1.0 dB (1.22×10 ⁻¹)	±0.05 dB (5.77×10 ⁻³)	±1.0 dB (1.22×10 ⁻¹)	±0.05 dB (5.77×10 ⁻³)
C	Cross Talk	-100 dB (1.00×10 ⁻⁵)	-110 dB (3.16×10 ⁻⁶)	-100 dB (1.00×10 ⁻⁵)	-110 dB (3.16×10 ⁻⁶)	-100 dB (1.00×10 ⁻⁵)	-110 dB (3.16×10 ⁻⁶)
R _{r1}	Port1 Refl. Connector Repeatability (Typical)	-70 dB (3.16×10 ⁻⁴)		-65 dB (5.62×10 ⁻⁴)		-65 dB (5.62×10 ⁻⁴)	
R _{t1}	Port1 Trans. Connector Repeatability (Typical)	-70 dB (3.16×10 ⁻⁴)		-65 dB (5.62×10 ⁻⁴)		-65 dB (5.62×10 ⁻⁴)	
R _{r2}	Port2 Refl. Connector Repeatability (Typical)	-70 dB (3.16×10 ⁻⁴)		-65 dB (5.62×10 ⁻⁴)		-65 dB (5.62×10 ⁻⁴)	
R _{t2}	Port2 Trans. Connector Repeatability (Typical)	-70 dB (3.16×10 ⁻⁴)		-65 dB (5.62×10 ⁻⁴)		-65 dB (5.62×10 ⁻⁴)	
N _l	Low-Level Noise ⁶	-110 dBm (3.16×10 ⁻⁶)		-110 dBm (3.16×10 ⁻⁶)		-100 dBm (1.00×10 ⁻⁵)	
N _h	High Level Noise ⁶	0.001 dB (1.15×10 ⁻⁴)		0.001 dB (1.15×10 ⁻⁴)		0.001 dB (1.15×10 ⁻⁴)	
A _m , A _p	Dynamic Accuracy Error	Refer to "Dynamic Accuracy" in this section					
S _{t1}	Port 1 Cable Trans. Phase Stability	0.025 degrees ⁷		0.025 degrees ⁷		0.025 degrees ⁸	
S _{r1}	Port 1 Cable Refl. Stability	-70 dB ⁷ (3.16×10 ⁻⁴)		-70 dB ⁷ (3.16×10 ⁻⁴)		-70 dB ⁸ (3.16×10 ⁻⁴)	
S _{t2}	Port 2 Cable Trans. Phase Stability	0.025 degrees ⁷		0.025 degrees ⁷		0.025 degrees ⁸	
S _{r2}	Port 2 Cable Refl. Stability	-70 dB ⁷ (3.16×10 ⁻⁴)		-70 dB ⁷ (3.16×10 ⁻⁴)		-70 dB ⁸ (3.16×10 ⁻⁴)	
T _{td}	Trans. Tracking Drift (Typical)	Magnitude: 0.0015 /°C Phase: 0.2 degrees/°C		Magnitude: 0.0015 /°C Phase: 0.2 degrees/°C		Magnitude: 0.0015 /°C Phase: 0.2 degrees/°C	
T _{rd}	Refl. Tracking Drift (Typical)	Magnitude: 0.015 /°C Phase: 0.2 degrees/°C		Magnitude: 0.015 /°C Phase: 0.2 degrees/°C		Magnitude: 0.015 /°C Phase: 0.2 degrees/°C	
T _{sw}	Switch Tracking	±0.03 dB (3.46×10 ⁻³)					
M _{sw}	Switch Port Match	-70 dB (3.16×10 ⁻⁴)					

1 Accuracy enhancement procedures are performed using HP 85031B 7 mm calibration kit.

2 Environmental temperature is 23°C ±5°C at calibration: ±1°C from calibration temperature must be maintained for valid measurement calibration.

3 Accuracy enhancement procedures are performed using HP 85032B 50 Ω type-N calibration kit.

4 Accuracy enhancement procedures are performed using HP 85036B 75 Ω type-N calibration kit.

5 Frequency range is 300 kHz to 500 MHz.

6 With IF bandwidth of 20 Hz.

7 Arrived at by bending HP 11857D cables out perpendicular to front panel and reconnecting. Stability is better with less flexing.

8 Arrived at by bending HP 11857B cables out perpendicular to front panel and reconnecting. Stability is better with less flexing.

DETERMINING EXPECTED SYSTEM PERFORMANCE

The uncertainty equations, dynamic accuracy calculations, and tables of system performance values provided in the preceding pages can be used to calculate the expected system performance. The following pages explain how to determine the residual errors of a particular system and combine them to obtain total error-corrected residual uncertainty values, using worksheets provided. The uncertainty graphs at the beginning of this *System Performance* section are examples of the results that can be calculated using this information.

Procedures

Table 2-4 is a worksheet used to calculate the residual uncertainty in reflection measurements. Table 2-5 is a worksheet for residual uncertainty in transmission measurements. Determine the linear values of the residual error terms and the nominal linear S-parameter data of the device under test as described below and enter these values in the worksheets. Then use the instructions and equations in the worksheets to combine the residual errors for total system uncertainty performance. The resulting total measurement uncertainty values have a confidence factor of 99.9%.

S-parameter Values. Convert the S-parameters of the test device to their absolute linear terms.

Noise Floor. Refer to the *Receiver Noise Level Performance Test* in the *Maintenance Manual* to determine the actual noise floor performance of your measurement setup.

Crosstalk. Refer to the *Input Crosstalk Performance Test*. Connect an impedance-matched load to each of the test ports and measure S_{21} or S_{12} after calibration. Turn on the marker statics function (see "Using Marker" in *Reference Manual*), and measure the mean value of the trace. Use the mean value plus one standard deviation as the residual crosstalk value of your system.

Dynamic Accuracy. Determine the absolute linear magnitude dynamic accuracy as described under *Dynamic Accuracy* in the chapter.

Other Error Terms. Refer to Table 2-3, depending on the test set and connector type in your system. Find the absolute linear magnitude of the remaining error terms.

Combining Error Terms. Combine the above terms using the reflection or transmission uncertainty equation in the worksheets.

Determining Expected System Performance

Table 2-4. Reflection Measurement Uncertainty Worksheet

In the columns below, enter the appropriate values for each term. Frequency: _____			
Error Term	Symbol	dB Value	Linear Value
Directivity	D	_____	_____
Reflection tracking	T _r	_____	_____
Source match	M _s	_____	_____
Load match	M _l	_____	_____
Dynamic accuracy (magnitude) ¹	A _m	_____	_____
Dynamic accuracy (phase) ¹	A _p	_____	_____
S ₁₁	S ₁₁	_____	_____
S ₂₁	S ₂₁	_____	_____
S ₁₂	S ₁₂	_____	_____
Noise floor ²	N _l	_____	_____
High level noise ²	N _h	_____	_____
Connector reflection repeatability	R _{r1} , R _{r2}	_____	_____
Connector transmission repeatability	R _{t1} , R _{t2}	_____	_____
Magnitude drift due to temperature	T _{rd} (mag)	_____	_____
Phase drift due to temperature	T _{rd} (phase)	_____	_____
Cable reflection stability	S _{r1} , S _{r2}	_____	_____
Cable transmission phase stability	S _{t1} , S _{t2}	_____	_____
Switch Tracking	T _{sw}	_____	_____
Switch Port Match	M _{sw}	_____	_____
Magnitude			
Combine Systematic Errors. In the space provided, enter the appropriate linear values from the list of errors. Then combine these errors to obtain the total sum of systematic errors.			
(1 + T _{sw}) × (D + S _{r1})	(_____ + _____) × (_____ + _____) = _____	(k)	
(T _{sw} + T _r) × S ₁₁	(_____ + _____) × _____ = _____	(l)	
(M _{sw} + S _{r1} + M _s) × S ₁₁ × S ₁₁	(_____ + _____ + _____) × _____ × _____ = _____	(m)	
M _l × S ₂₁ × S ₁₂	_____ × _____ × _____ = _____	(n)	
A _m × S ₁₁	_____ × _____ = _____	(o)	
Subtotal: k + l + m + n + o	_____ + _____ + _____ + _____ + _____ = _____	(S)	
Combine Random Errors. In the space provided, enter the appropriate linear values from the list of errors. Then combine these errors in an RSS fashion to obtain a total sum of the random errors.			
3 × N _l	3 × _____ = _____	(w)	
3 × N _h × S ₁₁	3 × _____ × _____ = _____	(x)	
R _{r1} + 2 × R _{t1} × S ₁₁ + R _{r1} × S ₁₁ × S ₁₁	_____ + 2 × _____ × _____ + _____ × _____ × _____ = _____	(y)	
R _{r2} × S ₂₁ × S ₁₂	_____ × _____ × _____ = _____	(z)	
$\sqrt{w^2 + x^2 + y^2 + z^2}$	$\sqrt{_____^2 + _____^2 + _____^2 + _____^2} = _____$	(R)	
Subtotal: S + R	_____ + _____ = _____	(V _r)	
Total Magnitude Errors:			
E _{rm} (linear) = V _r + T _{rd} (mag) × S ₁₁	_____ + (_____ × _____) = _____		
E _{rm} (log) = 20 Log(1 ± E _{rm} /S ₁₁)	20 Log(1 ± _____ / _____) = _____ dB		
Phase			
E _{rp} = Arcsin[(V _r - A _m × S ₁₁)/S ₁₁] + T _{rd} (phase) + 2 × S _{t1} + A _p	Arcsin[(_____ - _____ × _____) / _____] + _____ + 2 × _____ + _____ = ± _____ degrees		

1 With IF bandwidth of 20 Hz.
2 Included in dynamic accuracy.

Specifications

Determining Expected System Performance

Table 2-5. Transmission Measurement Uncertainty Worksheet

In the columns below, enter the appropriate values for each term. Frequency: _____			
Error Term	Symbol	dB Value	Linear Value
Crosstalk	C	_____	_____
Transmission tracking	T _t	_____	_____
Source match	M _s	_____	_____
Load match	M _l	_____	_____
Dynamic accuracy (magnitude) ¹	A _m	_____	_____
Dynamic accuracy (phase) ¹	A _p	_____	_____
S ₁₁	S ₁₁	_____	_____
S ₂₁	S ₂₁	_____	_____
S ₁₂	S ₁₂	_____	_____
S ₂₂	S ₂₂	_____	_____
Noise floor ²	N _l	_____	_____
High level noise ²	N _h	_____	_____
Connector reflection repeatability	R _{r1} , R _{r2}	_____	_____
Connector transmission repeatability	R _{t1} , R _{t2}	_____	_____
Magnitude drift due to temperature	T _{td} (mag)	_____	_____
Phase drift due to temperature	T _{td} (phase)	_____	_____
Cable reflection stability	S _{r1} , S _{r2}	_____	_____
Cable transmission phase stability	S _{t1} , S _{t2}	_____	_____
Switch Tracking	T _{sw}	_____	_____
Switch Port Match	M _{sw}	_____	_____

Magnitude	
Combine Systematic Errors. In the space provided, enter the appropriate linear values from the list of errors. Then combine these errors to obtain the total sum of systematic errors.	
C	_____ = _____ (k)
(T _{sw} + T _t) × S ₂₁	(_____ + _____) × _____ = _____ (l)
(M _{sw} + S _{r1} + M _s) × S ₁₁ × S ₂₁	(_____ + _____ + _____) × _____ × _____ = _____ (m)
(M _{sw} + S _{r2} + M _l) × S ₂₁ × S ₂₂	(_____ + _____ + _____) × _____ × _____ = _____ (n)
A _m × S ₂₁	_____ × _____ = _____ (o)
Subtotal: k + l + m + n + o	_____ + _____ + _____ + _____ + _____ = _____ (S)
Combine Random Errors. In the space provided, enter the appropriate linear values from the list of errors. Then combine these errors in an RSS fashion to obtain a total sum of the random errors.	
3 × N _l	3 × _____ = _____ (w)
3 × N _h × S ₂₁	3 × _____ × _____ = _____ (x)
R _{t1} × S ₂₁ + R _{r1} × S ₁₁ × S ₂₁	_____ × _____ + _____ × _____ × _____ = _____ (y)
R _{t2} × S ₂₁ + R _{r2} × S ₂₂ × S ₂₁	_____ × _____ + _____ × _____ × _____ = _____ (z)
$\sqrt{w^2 + x^2 + y^2 + z^2}$	$\sqrt{_____ \times _____ + _____ \times _____ + _____ \times _____ + _____ \times _____} = _____$ (R)
S + R	_____ + _____ = _____ (V _t)
Total Magnitude Errors:	
E _{tm} (linear) = V _t + T _{td} (mag) × S ₂₁	_____ + (_____ × _____) = _____
E _{tm} (log) = 20 Log(1 ± E _{tm} /S ₂₁)	20 Log(1 ± _____ / _____) = _____ dB
Phase	
E _{tp} = Arcsin[(V _t - A _m × S ₂₁)/S ₂₁] + T _{td} (phase) + S _{t1} + S _{t2} + A _p	Arcsin[(_____ - _____ × _____) / _____] + _____ + _____ + _____ + _____ = ± _____ degrees

1 With IF bandwidth of 20 Hz.
 2 Included in dynamic accuracy.

HP 8751A NETWORK ANALYZER
REFERENCE MANUAL



Printed in JAPAN August 1994



GUIDE TO THE CHAPTERS IN THIS DOCUMENT

For information on specific topics, refer to the index at the end of this volume.

This section of this document is a complete reference for operation of the HP 8751A Network Analyzer using either front panel controls, or an external controller. The information in this reference is intended to supplement the separately included tutorial documents in this volume with additional details. It is divided into chapters providing the following information:

- Chapter 1 includes a block diagram and functional description of the analyzer system. This is followed by descriptions of the front panel features and display labels, and the rear panel features and connectors.
- Chapters 2 through 11 provide detailed information on front panel keys and softkeys, their purpose and use, HP-IB equivalents in parentheses, and expected indications and results. Specific areas of operation described in these chapters include calibration procedures for accuracy enhancement, using markers, limit testing, plotting and printing, and saving instrument states.
- Chapter 12 contains information for operating the system remotely with a controller through HP-IB.
- Appendix provides a complete listing of the instrument preset state, a map of the operating softkey menu structure, information on I/O ports, and information on manual changes.
- Error Messages lists analyzer error messages, with explanations.
- Index lists an alphabetical index.

Safety Symbols

General definitions of safety symbols used on equipment or in manuals.



Instruction manual symbol: the product will be marked with this symbol when it is necessary for the user to refer to the instruction manual in order to protect against damage to the instrument.



Indicates dangerous voltage (terminals fed from the interior by voltage exceeding 1000 volts must be so marked).

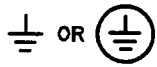

Protective conductor terminal. For protection against electrical shock in case of a fault. Used with wiring terminals to indicate the terminal which must be connected to ground before operating equipment.



Low-noise or noiseless, clean ground (earth) terminal. Used for a signal common, as well as providing protection against electrical shock in case of fault. A terminal marked with this symbol must be connected to ground before operating the equipment.

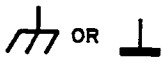

Frame or chassis terminal. A connection to the frame (chassis) of the equipment which normally includes all exposed metal structures.



Alternating current (power line).



Direct current (power line).



Alternating or direct current (power line).

Warning



Warning denotes a hazard. It calls attention to a procedure, practice, condition or the like, which, if not correctly performed or adhered to, could result in injury or death to personnel.

Caution



Caution sign denotes a hazard. It calls attention to a procedure, practice, condition or the like, which, if not correctly performed or adhered to, could result in damage to or destruction of part or all of the product.

Note



Note denotes important information. It calls attention to a procedure, practice, condition or the like, which is essential to highlight.

Contents

1. System Overview	
SYSTEM OVERVIEW	1-1
Overall Operation	1-2
The Built-In Synthesized Source	1-2
Test Sets	1-2
The Receiver Block	1-2
The Built-In Attenuators	1-2
The Microprocessors	1-2
Calibration Standards	1-3
DATA PROCESSING	1-4
Overview	1-4
Important Concepts	1-4
Processing Details	1-6
The ADCs	1-6
Digital Filter	1-6
IF Correction	1-6
Ratio Calculations	1-6
Input Attenuator Correction	1-6
Sweep-to-sweep Averaging	1-6
Raw Data Arrays	1-6
Vector Error Correction (accuracy enhancement)	1-6
Trace Math Operation	1-7
The Delay Block (Electrical Delay)	1-7
Conjugate Matching	1-7
Conversion Transforms	1-7
Unformat Data Arrays	1-7
Formatting	1-7
Smoothing	1-7
Format Arrays	1-8
Scaling	1-8
Display Memory	1-8
2. Front and Rear Panel	
INTRODUCTION	2-1
ACTIVE FUNCTION	2-1
FRONT PANEL KEYS AND SOFTKEY MENUS	2-1
Softkeys that are Joined by Vertical Lines	2-2
Softkeys That Toggle On or Off	2-2
Softkeys that Show Status Indications in Brackets	2-2
Function Key Blocks	2-2
Stimulus Block	2-2
Response Block	2-2

Instrument State Block	2-2
HP-IB Control	2-3
Information on Keys and Softkeys	2-3
FRONT PANEL FEATURES	2-4
CRT DISPLAY	2-6
REAR PANEL FEATURES AND CONNECTORS	2-9
3. Active Channel Block	
ACTIVE CHANNEL KEYS	3-1
4. Entry Block	
ENTRY BLOCK KEYS	4-1
5. Stimulus Function Block	
INTRODUCTION	5-1
MECHANICAL SWITCH HOLD	5-2
Output Power Switch	5-2
Test Port Transfer Switch	5-2
MEASURE RESTART and NUMBER of GROUPS Softkeys	5-2
START, STOP, CENTER, AND SPAN KEYS	5-3
MENU KEY	5-4
Stimulus Menu	5-5
Power Menu	5-7
Sweep Time Menu	5-8
Trigger Menu	5-10
Sweep Type Menu	5-11
List Sweep Menu	5-13
Edit List Menu	5-13
Edit Segment Menu	5-15
Edit Segment More Menu	5-17
Clear List Menu	5-18
6. Response Function Block	
INTRODUCTION	6-1
MEAS KEY	6-2
S-Parameters	6-3
DC Voltage Measurement	6-4
S-Parameter Menu	6-4
Input Ports Menu	6-6
Conversion Menu	6-7
Conversion More Menu	6-9
FORMAT KEY	6-10
Format Menu	6-10
Format More Menu	6-14
GROUP DELAY PRINCIPLES	6-17
SCALE REF KEY	6-20
Scale Reference Menu	6-20
Electrical Delay Menu	6-22
DISPLAY KEY	6-24
Display Menu	6-25
Problems with Dual Channel Mode	6-25

Display More Menu	6-27
Display Allocation Menu	6-27
Trace Math Menu	6-28
Title Menu	6-30
Conjugate Matching Menu	6-31
Select Circuit Menu	6-33
Adjust Display Menu	6-34
Modify Colors Menu	6-35
Modify Colors More Menu (Option 002 only)	6-36
Pen Menu (Option 002 only)	6-37
Color Adjust Menu	6-38
Adjusting Color	6-38
Setting Default Colors	6-39
Saving Modified Colors	6-39
Recalling Modified Colors	6-39
AVG KEY	6-40
Averaging	6-40
Smoothing	6-41
IF Bandwidth Reduction	6-41
Group Delay Aperture	6-42
Average Menu	6-42
IF Bandwidth Menu	6-44
ATTEN KEY	6-45
Attenuator Menu	6-45
7. Measurement Calibration	
INTRODUCTION	7-1
ACCURACY ENHANCEMENT	7-1
SOURCES OF MEASUREMENT ERRORS	7-2
Directivity	7-2
Source Match	7-3
Load Match	7-4
Isolation (Crosstalk)	7-5
Frequency Response (Tracking)	7-6
CORRECTING FOR MEASUREMENT ERRORS	7-6
CAL Key	7-8
Standard Devices	7-9
Interpolated Error Correction	7-9
Channel Coupling	7-9
Measurement Parameters	7-10
Device Measurements	7-10
Omitting Isolation Calibration	7-10
Stopping During the Calibration Procedure	7-10
Saving Calibration Data	7-10
Specifying Calibration Kits	7-10
Correction Menu	7-11
Select Cal Kit Menu	7-12
Calibrate More Menu	7-14
Reference Plane Menu	7-15
DC Correction Menu	7-16
Calibration Menu	7-17

Response Calibration for Reflection Measurements	7-20
Response Calibration for Transmission Measurements	7-21
Response and Isolation Calibration for Reflection Measurements	7-22
Response and Isolation Calibration for Transmission Measurements	7-24
S ₁₁ 1-Port Calibration for Reflection Measurements	7-25
S ₂₂ 1-Port Calibration	7-27
Full 2-Port Calibration for Reflection and Transmission Measurements	7-28
One-Path 2-Port Calibration for Reflection and Transmission Measurements	7-32
MODIFYING CALIBRATION KITS	7-36
Definitions	7-37
Procedure	7-37
Modify Cal Kit Menu	7-37
Define Standard Number Menu	7-38
Define Standard Menus	7-39
Specify Offset Menu	7-42
Label Standard Menu	7-43
Specify Class Menus	7-44
Label Class Menus	7-46
Label Kit Menu	7-47
Verify Performance	7-47
Example Procedure for Specifying a User-Defined Calibration Kit	7-47
APPENDIX TO CHAPTER 7	7-52
Accuracy Enhancement Fundamentals-Characterizing Systematic Errors	7-52
One-Port Error Model	7-52
Measuring reflection coefficient	7-52
Directivity error	7-52
Source match error	7-53
Frequency response error	7-53
How calibration standards are used to quantify these error terms	7-54
Two-Port Error Model	7-56
Measuring Transmission Coefficient	7-57
Load Match Error	7-57
Isolation Errors	7-58
Error Terms the Analyzer Can Reduce	7-58
8. Using Markers	
MKR KEY	8-1
MARKER MENU	8-4
Activate marker menu	8-5
Clear Marker Menu	8-6
Delta Marker Mode Menu	8-7
Delta Marker Menu	8-8
Fixed Marker Menu	8-9
Marker Mode Menu	8-10
Polar Marker Menu	8-11
Smith Marker Menu	8-12
MKR FCTN KEY	8-14
Marker Function Menu	8-15
Search Range Menu	8-16
Marker Search Menu	8-17
Target Menu	8-18

Marker Search More Menu	8-19
Note For Peak Define	8-20
Width Menu	8-21
9. Instrument State Function Block	
INTRODUCTION	9-1
INSTRUMENT STATE FUNCTIONS AND WHERE THEY ARE DESCRIBED	9-2
LOCAL Key	9-3
Local Lockout	9-3
HP-IB Menu	9-3
System Controller Mode	9-4
Addressable Mode	9-4
Address Menu	9-5
SYSTEM KEY	9-7
System Menu	9-7
Clock Menu	9-8
Set Time Menu	9-9
Set Date Menu	9-10
LIMIT LINE AND LIMIT TESTING	9-11
How Limit Lines are Entered	9-13
Turning Limit Lines Limit Testing On and Off	9-14
Segments Entering Order Needs Notice	9-14
Saving the Limit Line Table	9-14
Offsetting the Stimulus or Amplitude of the Limit Lines	9-14
Supported Display Formats	9-14
Use a Sufficient Number of Points or Errors May Occur	9-15
Displaying, Printing, or Plotting Limit Test Data	9-15
Results of Plotting or Printing the Display with Limit Lines ON	9-15
Limit Menu	9-16
Edit Limits Menu	9-17
Edit Segment Menu	9-18
Clear List Menu	9-20
Offset Limit Menu	9-21
INSTRUMENT BASIC (Option 002)	9-22
10. Making Hard Copies	
INTRODUCTION	10-1
About Making Hard Copies, Where Compatible Printers and Plotters are Mentioned	10-1
Where to Find Tutorial Information	10-1
Printing/Plotting with or without a Controller on the Bus	10-1
PRINT/PLOT BUFFER	10-2
COPY KEY	10-2
Copy Menu	10-4
Print/Plot Setup Menu	10-5
Select Quadrant Menu	10-6
Define Plot Menu	10-7
Pen Numbers	10-7
Scale Plot Menu	10-8
Copy More Menu	10-10

Copy Cal Kit Menu	10-12
Copy Standard Number Menu	10-13
Copy List Sweep Menu	10-13
Copy Limit Test Menu	10-14
Screen Menu	10-15
Configure Plot Menu	10-16
Configure Plot More Menu	10-17
11. Saving and Recalling Instrument States and Data	
INTRODUCTION	11-1
STORAGE DEVICES	11-1
RAM Disk Memory Capacity	11-1
Operating Time of the Battery Backup for RAM Disk Memory	11-2
Copy Files Between the RAM Disk and the Flexible Disk	11-2
FILE TYPES AND DATA SAVED	11-2
Binary Files and ASCII Files	11-2
Data Groups	11-2
Instrument States	11-3
Internal Data Arrays	11-3
Instrument States and Internal Data Arrays	11-3
Internal Data Arrays (ASCII file)	11-4
Graphics	11-4
ADDITIONAL INFORMATION	11-4
Disk Requirements	11-4
Disk Formats	11-4
File Names	11-4
Auto Recall Function	11-5
File Size	11-5
File Structure of Internal Data Arrays File for Binary Files	11-6
File Header	11-6
Data Group	11-7
Data Segment	11-8
File Structure of Internal Data Arrays File for ASCII File	11-8
Status Block and Data Block	11-8
File Structure for Single Channel and Dual Channel	11-10
Data Array Names	11-11
Data Groups	11-11
SAVE AND RECALL KEYS	11-13
Save Menu	11-15
Title Menu	11-16
ASCII Save Menu	11-17
Define Extension Menu	11-18
Define Save Data Menu	11-19
Re-save File Menu	11-20
Disk Menu	11-21
Purge File Menu	11-22
Purge Menu	11-23
Initialize Menu	11-24
Recall File Menu	11-25

12. HP-IB Remote Programming	
INTRODUCTION	12-1
HOW HP-IB WORKS	12-2
Talker	12-2
Listener	12-2
Controller	12-2
HP-IB REQUIREMENTS	12-2
ANALYZER HP-IB CAPABILITIES	12-3
BUS MODE	12-3
SETTING ADDRESSES	12-4
A. Default	
PRESET STATE	A-1
PREDEFINED CALIBRATION KIT	A-7
Predefined Standards	A-7
Predefined Standard Class Assignments	A-9
B. Menu Map	
INTRODUCTION	B-1
C. I/O Port	
I/O PORT	C-1
Pin Assignment	C-1
Related HP-IB Commands	C-2
Using The I/O Port Without an External Controller nor Instrument BASIC	C-2
D. Manual Changes	
INTRODUCTION	D-1
MANUAL CHANGES	D-1
CHANGE 1 FOR GENERAL INFORMATION	D-2
Page 1-2, "Waveform Analysis Commands"	D-2
CHANGE 1 FOR REFERENCE MANUAL	D-2
Page 1-7, "Conversion Transforms"	D-2
Conversion Transforms	D-2
Page 2-5, "FRONT PANEL FEATURES"	D-2
Page 2-6, "CRT DISPLAY"	D-2
Page 6-2, "MEAS KEY"	D-2
Page 6-8, "Conversion Menu"	D-3
Page 6-9, "Conversion More Menu"	D-3
Page 6-24, "Figure 6-30."	D-3
Page 6-36, "Modify Colors More Menu"	D-3
Page 6-37, "Pen Menu"	D-3
Page 8-2	D-3
Page 10-1, "INTRODUCTION"	D-3
Page 10-7, "Define Plot Menu"	D-4
Page 11-1, "STORAGE DEVICES"	D-4
Page 11-2, "Binary Files and ASCII Files"	D-4
Page 11-2, "Data Groups"	D-4
Page 11-4, "Internal Data Arrays (ASCII file)"	D-4
Page 11-4, "Graphics"	D-4
Page 11-4, "Disk Formats"	D-4

Page 11-4, "File Names"	D-4
Page 11-4, "Table 11-1. Valid Characters for File Names"	D-5
Page 11-5, "Table 11-2. Suffixes and Extensions Added Automatically"	D-5
Page 11-5, "Table 11-4. File Size Versus Number of Points (ASCII files) 1/2"	D-5
Page 11-6, "Table 11-5. File Size Versus Number of Points (ASCII files) 2/2"	D-5
Page 11-6, "File Structure of Internal Data Arrays File for Binary Files"	D-5
Page 11-8, "File Structure of Internal Data Arrays File for ASCII File"	D-5
Page 11-14, "Figure 11-5."	D-5
Page 11-15, "Save Menu"	D-7
Page 11-15	D-8
Save File Menu	D-8
Page 11-16, "Title Menu"	D-9
Page 11-17, "ASCII Save Menu"	D-10
Page 11-18, "Define Extension Menu"	D-10
Page 11-20, "Re-save File Menu"	D-10
Page 11-21, "Disk Menu"	D-11
Page 11-22, "Purge File Menu"	D-12
Page 11-24, "Initialize Menu"	D-12
Page 11-25	D-13
Recall Menu	D-13
Page 11-25, "Recall File Menu"	D-14
Page A-6, "Table A-6. Preset Conditions"	D-14
Page A-6, "Table A-7, Results of Power Loss to Battery Backup Memory (Factory Setting)"	D-14
Page B-1, "Figure B-1"	D-15
Page B-2, "Figure B-2"	D-15
Page B-5, "Figure B-5"	D-15
Page E-3, "Figure E-2"	D-15
Page E-5, "Figure E-5"	D-15
Page E-19, "Figure E-21"	D-15
Page Message-3, "ERROR MESSAGES IN ALPHABETICAL ORDER"	D-17
Page Message-18, "ERROR MESSAGES IN NUMERICAL ORDER"	D-17
CHANGE 1 FOR USER'S GUIDE	D-18
Page 5-12, "Disk Drive Tutorial"	D-18
Page 5-12, "Saving Procedure"	D-18
Saving Procedure	D-18
Page 5-12, "Recalling Procedure (LIF Format Disk)"	D-18
Page 5-13, "Recall Procedure (DOS Format Disk)"	D-19
Page 5-14, "Saving Display Image"	D-19
Page 5-13, "Move Working Directory"	D-19
CHANGE 2 FOR REFERENCE MANUAL	D-20
Page 11-1, "STORAGE DEVICES"	D-20
Page 11-5, "Auto Recall Function"	D-20
Auto Recall Function	D-20
Page 11-14, "Figure 11-5."	D-20
Page 11-15, "Save Menu"	D-22
Page 11-16, "Title Menu"	D-23
Page 11-20, "Re-save File Menu"	D-24
Page 11-21, "Disk Menu"	D-25
Page 11-22, "Purge File Menu"	D-26
Page 11-21	D-27

Define Format Menu	D-27
Page 11-25, "Recall File Menu"	D-28
Page E-19, "Figure E-21"	D-29
Page B-5, "Figure B-5"	D-30
CHANGE 2 FOR USER'S GUIDE	D-31
Page 5-12, "Disk Drive Tutorial"	D-31
Disk Drive Tutorial	D-31
Saving Procedure	D-31
CHANGE 3 for General Information	D-32
Page 2-5, Dynamic Accuracy	D-32
Page 2-6, Dynamic Accuracy	D-33
CHANGE 3 FOR Reference Manual	D-33
Page 10-3, Figure 10-1	D-33
Page 10-5, Copy Menu	D-35
Page 10-5, Copy Menu	D-35
Page 10-18, Configure Plot Menu	D-36
Page 10-19, Configure Plot More Menu	D-36
E. Softkey Tree	
STIMULUS BLOCK	E-2
RESPONSE BLOCK	E-3
INSTRUMENT STATE FUNCTION BLOCK	E-16
Messages	
ERROR MESSAGES IN ALPHABETICAL ORDER	Messages-1
ERROR MESSAGES IN NUMERICAL ORDER	Messages-14
Index	

Figures

1-1. Simplified Block Diagram of the Network Analyzer System	1-1
1-2. Data Processing Flow Diagram	1-5
2-1. HP 8751A Front Panel	2-4
2-2. CRT Display (Single Channel, Cartesian Format)	2-6
2-3. HP 8751A Rear Panel	2-9
3-1. Active Channel Keys	3-1
4-1. Entry Block	4-1
5-1. Stimulus Function Block	5-1
5-2. Softkey Menus Accessed from the MENU Key	5-4
5-3. Stimulus Menu	5-5
5-4. Power Menu	5-7
5-5. Sweep Time Menu	5-8
5-6. Trigger Menu	5-10
5-7. Sweep Type Menu	5-11
5-8. List Sweep Menu	5-13
5-9. Edit List Menu	5-14
5-10. Edit Segment Menu	5-15
5-11. Edit Segment More Menu	5-17
5-12. Clear List Menu	5-18
6-1. Response Function Block	6-1
6-2. Softkey Menus Accessed from the MEAS Key	6-2
6-3. S-Parameters of a Two-Port Device	6-3
6-4. S-Parameter Menu	6-5
6-5. Input Ports Menu	6-6
6-6. Reflection Impedance and Admittance Conversions	6-7
6-7. Transmission Impedance and Admittance Conversions	6-7
6-8. Conversion Menu	6-8
6-9. Conversion More Menu	6-9
6-10. Format and Format More Menus	6-10
6-11. Log Magnitude Format	6-11
6-12. Phase Format	6-11
6-13. Group Delay Format	6-12
6-14. Smith Chart Format	6-12
6-15. Polar Format	6-13
6-16. Linear Magnitude Format	6-13
6-17. Typical SWR Display	6-14
6-18. Real Format	6-14
6-19. Expanded phase Format	6-15
6-20. Inverse Smith Chart Formats	6-15
6-21. Log Magnitude and Phase Format	6-16
6-22. Log magnitude and Delay Format	6-16
6-23. Constant Group Delay	6-17

6-24. Higher Order Phase Shift	6-17
6-25. Rate of Phase Change Versus Frequency	6-18
6-26. Variations in Frequency Aperture	6-18
6-27. Softkey Menus Accessed from the SCALE REF Key	6-20
6-28. Scale Reference Menu	6-20
6-29. Electrical Delay Menu	6-22
6-30. Softkey Menus Accessed from the DISPLAY Key	6-24
6-31. Display Menu	6-25
6-32. Full-screen and Split Display	6-26
6-33. Display More Menu	6-27
6-34. Display Allocation Menu	6-28
6-35. Trace Math Menu	6-29
6-36. Title Menu	6-30
6-37. Conjugate Matching Menu	6-31
6-38. Matching Circuits	6-32
6-39. Select Circuit Menu	6-33
6-40. Adjust Display Menu	6-34
6-41. Modify Colors Menu	6-35
6-42. Modify Colors More Menu	6-36
6-43. Pen Menu	6-37
6-44. Color Adjust Menu	6-38
6-45. Softkey Menus Accessed from the AVG Key	6-40
6-46. Effect of Averaging on a Trace	6-40
6-47. Effect of Smoothing on a Trace	6-41
6-48. IF Bandwidth Reduction	6-42
6-49. Average Menu	6-42
6-50. IF Bandwidth Menu	6-44
6-51. Attenuator Menu	6-45
7-1. Directivity	7-3
7-2. Source Match	7-4
7-3. Load Match	7-5
7-4. Response vs. S_{11} 1-Port Calibration on Log Magnitude Format	7-7
7-5. Response vs. Full Two-Port Calibration	7-7
7-6. Softkey Menus Accessed from the CAL Key	7-8
7-7. Correction Menu	7-11
7-8. Select Cal Kit Menu	7-13
7-9. Calibrate More Menu	7-14
7-10. Reference Plane Menu	7-15
7-11. DC Correction Menu	7-16
7-12. Calibration Menu	7-18
7-13. Response Cal Menu	7-20
7-14. Response and Isolation Cal Menu and Response Cal Menu	7-22
7-15. S_{11} and S_{22} 1-Port Cal Menus	7-25
7-16. Full 2-Port Cal Menu	7-29
7-17. One-Path 2-Port Cal Menu	7-33
7-18. Modify Cal Kit Menu	7-37
7-19. Define Standard Number Menu	7-38
7-20. Define Standard Menus	7-40
7-21. Specify Offset Menu	7-42
7-22. Label Standard Menu	7-43
7-23. Specify Class Menus	7-45

7-24. Label Class Menu	7-46
7-25. Sources of Error in a Reflection Measurement	7-52
7-26. Reflection Coefficient	7-52
7-27. Effective Directivity E_{DF}	7-53
7-28. Source Match E_{SF}	7-53
7-29. Reflection Tracking E_{RF}	7-54
7-30. "Perfect Load" Termination	7-54
7-31. Measured Effective Directivity	7-55
7-32. Short Circuit Termination	7-55
7-33. Open Circuit Termination	7-56
7-34. Measured S_{11}	7-56
7-35. Major Sources of Error	7-57
7-36. Transmission Coefficient	7-57
7-37. Load Match E_{LF}	7-58
7-38. Isolation E_{XF}	7-58
7-39. Full Two-Port Error Model	7-59
8-1. Markers on Trace	8-1
8-2. Menus Accessed from the MKR Key	8-3
8-3. Marker Menu	8-4
8-4. Activate Marker Menu	8-5
8-5. Clear Marker Menu	8-6
8-6. Delta Marker Mode Menu	8-7
8-7. Delta Marker Menu	8-8
8-8. Fixed Marker Menu	8-9
8-9. Marker Mode Menu	8-10
8-10. Polar Marker Menu	8-11
8-11. Smith Marker Menu	8-12
8-12. Menus Accessed from the MKR FCTN Key	8-14
8-13. Marker Function Menu	8-15
8-14. Search Range Menu	8-16
8-15. Marker Search Menu	8-17
8-16. Target Menu	8-18
8-17. Marker Search More Menu	8-19
8-18. Peak Definition Example	8-20
8-19. Width Menu	8-21
8-20. Bandwidth Search Example	8-22
9-1. Instrument State Function Block	9-1
9-2. Softkey Menus Accessed from the LOCAL Key	9-3
9-3. HP-IB Menu	9-4
9-4. Address Menu	9-6
9-5. System Menu	9-7
9-6. Softkey Menus Accessed from the SET CLOCK Softkey	9-8
9-7. Clock Menu	9-8
9-8. Set Time Menu	9-9
9-9. Set Date Menu	9-10
9-10. Softkey Menus Access from the LIMIT MENU softkey.	9-12
9-11. The Concept of Segments as a Point between Two Sets of Limit Lines	9-13
9-12. Limits Menu	9-16
9-13. Edit Limits Menu	9-18
9-14. Edit Segment Menu	9-19

9-15. Clear List Menu	9-20
9-16. Offset Limit Menu	9-21
10-1. Softkey Menus Accessed from the COPY Key	10-3
10-2. Copy Menu	10-4
10-3. Print/Plot Setups Menu	10-5
10-4. Select Quadrant Menu	10-6
10-5. Define Plot Menu	10-7
10-6. Scale Plot Menu	10-8
10-7. Full, Upper, and Lower Graticule	10-9
10-8. Copy More Menu	10-10
10-9. Copy Cal Kit Menu	10-12
10-10. Copy Standard Number Menu	10-13
10-11. Copy List Sweep Menu	10-13
10-12. Copy Limit Test Menu	10-14
10-13. Screen Menu	10-15
10-14. Configure Plot Menu	10-16
10-15. Configure Plot More Menu	10-17
11-1. File Header Structure	11-6
11-2. RAW Data Group Structure	11-7
11-3. CAL Data Group Structure	11-7
11-4. Data Segment	11-8
11-5. Softkey Menus Accessed from the SAVE and RECALL Keys	11-14
11-6. Save Menu	11-15
11-7. Title Menu	11-16
11-8. ASCII Save Menu	11-17
11-9. Define Extension Menu	11-18
11-10. Define Save Data Menu	11-19
11-11. Re-save File Menu	11-20
11-12. Disk Menu	11-21
11-13. Purge File Menu	11-22
11-14. Purge Menu	11-23
11-15. Initialize Menu	11-24
11-16. Recall File Menu	11-25
12-1. Analyzer Single Bus Concept	12-4
B-1. Operating Softkey Menu Map (1 of 5)	B-1
B-2. Operating Softkey Menu Map (2 of 5)	B-2
B-3. Operating Softkey Menu Map (3 of 5)	B-3
B-4. Operating Softkey Menu Map (4 of 5)	B-4
B-5. Operating Softkey Menu Map (5 of 5)	B-5
C-1. I/O Port Pin Assignments	C-1
C-2. An Example of a Test System Without Controller	C-2
D-1. Dynamic Accuracy (Amplitude)	D-32
D-2. Dynamic Accuracy (Phase)	D-33
E-1. MENU key	E-2
E-2. MEAS Key	E-3
E-3. FORMAT Key	E-3
E-4. SCALE REF Key	E-4
E-5. DISPLAY Key	E-5
E-6. AVG Key	E-6
E-7. CAL Key	E-7
E-8. CAL Key	E-8

E-9.	CAL Key	E-9
E-10.	CAL Key	E-10
E-11.	CAL Key	E-11
E-12.	CAL Key	E-12
E-13.	CAL Key	E-13
E-14.	CAL Key	E-13
E-15.	MKR Key	E-14
E-16.	MKR FCTN Key	E-15
E-17.	LOCAL Key	E-16
E-18.	SYSTEM Key	E-16
E-19.	SYSTEM Key	E-17
E-20.	COPY Key	E-18
E-21.	SAVE and RECALL Key	E-19

Tables

5-1. Minimum Sweep Time In Seconds (Typical Value)	5-9
6-1. IF Bandwidth in AUTO mode	6-44
7-1. Differences between PORT EXTENSIONS and ELECTRICAL DELAY	7-14
7-2. Purpose and Use of Different Calibration Procedures	7-19
7-3. Standard Definitions	7-39
7-4. Standard Class Assignments Table	7-44
7-5. 3.5 mm Standard Cal Kit	7-48
7-6. Standard Class Assignments Table for User-Defined Calibration Kit	7-49
9-1. Instrument State Function Descriptions	9-2
9-2. Default HP-IB Addresses	9-5
10-1. Default Plotting Parameters	10-6
10-2. Pen Numbers	10-7
10-3. List Value Format	10-11
11-1. Valid Characters for File Names	11-4
11-2. Suffixes and Extensions Added Automatically	11-5
11-3. File Size Versus Number of Points (binary files)	11-5
11-4. File Size Versus Number of Points (ASCII files) 1/2	11-5
11-5. File Size Versus Number of Points (ASCII files) 2/2	11-6
11-6. Contents of ASCII Files	11-9
11-7. Data Groups and Data Array Names	11-11
11-8. Measurement Type Versus Raw Data Saved	11-12
11-9. Calibration Type Versus CAL Data Saved	11-12
A-1. Preset Conditions	A-1
A-2. Preset conditions	A-2
A-3. Preset conditions	A-3
A-4. Preset conditions	A-4
A-5. Preset conditions	A-5
A-6. Preset Conditions	A-6
A-7. Results of Power Loss to Battery Backup Memory (Factory Setting)	A-6
A-8. 7 mm Standard Cal Kit	A-7
A-9. 50 Ω Type-N Standard Cal Kit	A-7
A-10. 75 Ω Type-N Standard Cal Kit	A-8
A-11. Standard Class Assignments Table (7 mm)	A-9
A-12. Standard Class Assignments Table (50 Ω Type-N)	A-9
A-13. Standard Class Assignments Table (75 Ω Type-N)	A-10
D-1. Manual Changes by Serial Number	D-1
D-2. Manual Changes by Firmware Version	D-1

System Overview

SYSTEM OVERVIEW

Network analyzers measure the reflection and transmission characteristics of devices and networks by applying a known swept signal and measuring the response of the test device. The signal transmitted through the device or reflected from its input is compared with the incident signal generated by a swept RF source. The signals are applied to a receiver for measurement, signal processing, and display. A network analyzer system consists of a source, signal separation devices, a receiver, and a display.

The HP 8751A vector network analyzer integrates a high resolution synthesized RF source and a dual channel three-input receiver to measure and display magnitude, phase, and group delay of transmitted and reflected power. The HP 8751A Option 002 has the additional capability of programing the measurement sequence and controlling other HP-IB instruments without an external controller. Other options are explained in the General Information and Specifications sections. Figure 1-1 is a simplified block diagram of the network analyzer system. A detailed block diagram of the analyzer is provided in the *Service Manual* (HP Part Number:08751-90031), together with complete theory of system operation.

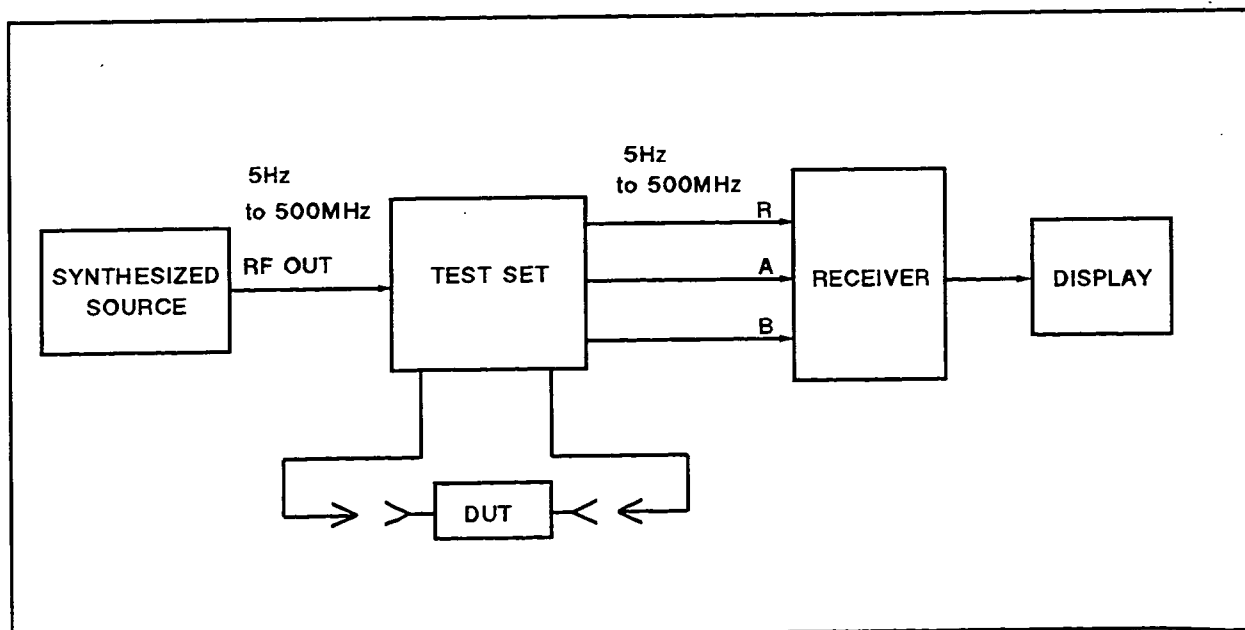

C201001

Figure 1-1. Simplified Block Diagram of the Network Analyzer System

System Overview

Overall Operation

The source RF signal is transmitted through the device under test (DUT) and is then applied to the B input of the receiver. The portion of the signal that reflects off the DUT's input port is coupled to the receiver's A input. The A and B inputs are compared to the original signal at the R input to characterize the reflection and transmission response of the DUT.

The Built-In Synthesized Source

The analyzer's built-in synthesized source produces a swept RF signal in the range of 5 Hz to 500 MHz. The RF output power is leveled by an internal ALC (automatic leveling control) circuit. To achieve frequency accuracy and phase measuring capability, the analyzer is phase-locked to a highly stable crystal oscillator.

Test Sets

A test set provides connections to the device under test, as well as the signal separation devices that separate the incident signal from the transmitted and reflected signals. The incident signal is applied to the R (reference) input, and the reflected and transmitted signals are applied to the A or B inputs.

The HP 87511A,B S-parameter test sets contain the hardware required to make simultaneous transmission and reflection measurements in both the forward and reverse directions. An RF path switch in the test set is controlled by the network analyzer so that reverse measurements can be made without changing the connections to the device under test. The HP 87512A,B Transmission/Reflection Test Kits contain the hardware required to make simultaneous transmission and reflection measurements in one direction only. The HP 11850C,D three-way power splitters or the HP 11667A two-way power splitter can be used for making transmission-only measurements.

The Receiver Block

The receiver block contains identical mixers for the R, A, and B inputs. The signals are mixed to produce a 5 kHz IF (intermediate frequency) to be converted to digital data. Both amplitude and phase information are measured simultaneously, regardless of what is displayed on the CRT.

The Built-In Attenuators

The built-in attenuators in the HP 8751A adjust the power level to the reference port and test ports of the HP 8751A without changing the level of the incident power to the DUT. The built-in attenuators are controlled from the front panel of the analyzer.

The Microprocessors

The microprocessors take the raw data and perform all the required error correction, trace math, formatting, scaling, and marker operations, according to the instructions from the front panel. The formatted data is then displayed on the CRT. The data processing sequence is described below.

Calibration Standards

In addition to the analyzer and the test set (or power splitter), a measurement may require calibration standards for vector accuracy enhancement, and cables for interconnections. Model numbers and details of compatible power splitters, calibration kits, and cables are provided in General Information and Specifications.

DATA PROCESSING

Overview

The analyzer's receiver converts the R, A, and B input signals into useful measurement information. This conversion occurs in two main steps. First, the swept high frequency input signals are translated to fixed low frequency IF signals, using analog mixing techniques. Refer to "Theory of Operation" in the *Service Manual* for details. Second, the IF signals are converted into digital data by an analog-to-digital converter (ADC). From this point on, all further signal processing is performed mathematically by the analyzer microprocessors. The following paragraphs describe the sequence of math operations and the resulting data arrays as the information flows from the ADC to the display. They provide a good foundation for understanding most of the response functions, and the order in which they are performed.

Figure 1-2 is a data processing flow diagram that represents the flow of numerical data from IF detection to display. The data passes through several math operations, denoted in the figure by single-line boxes. Most of these operations can be selected and controlled with the front panel RESPONSE block menus. The data is also stored in data arrays along the way, denoted by double-line boxes. These arrays are places in the flow path where data is accessible via HP-IB or using the internal disk drive.

Important Concepts

- **Stimulus** is whatever is being measured on the display x-axis (frequency, or power).
- A **data point** or **point** is a single piece of data representing a measurement at a single stimulus value. Most data processing operations are performed point-by-point; some involve more than one point.
- A **sweep** is a series of consecutive data point measurements, taken over a sequence of stimulus values. A few data processing operations require that a full sweep of data is available. The number of points per sweep is user defined, while the default number of points is 201. Note that the meaning of the stimulus values (independent variables) can change, depending on the *sweep type*, although this does not generally affect the data processing path. Examples of sweep types are linear frequency, logarithmic frequency, power sweep. Frequency list mode is the last sweep type, it allows you to choose specific stimulus points to be measured.

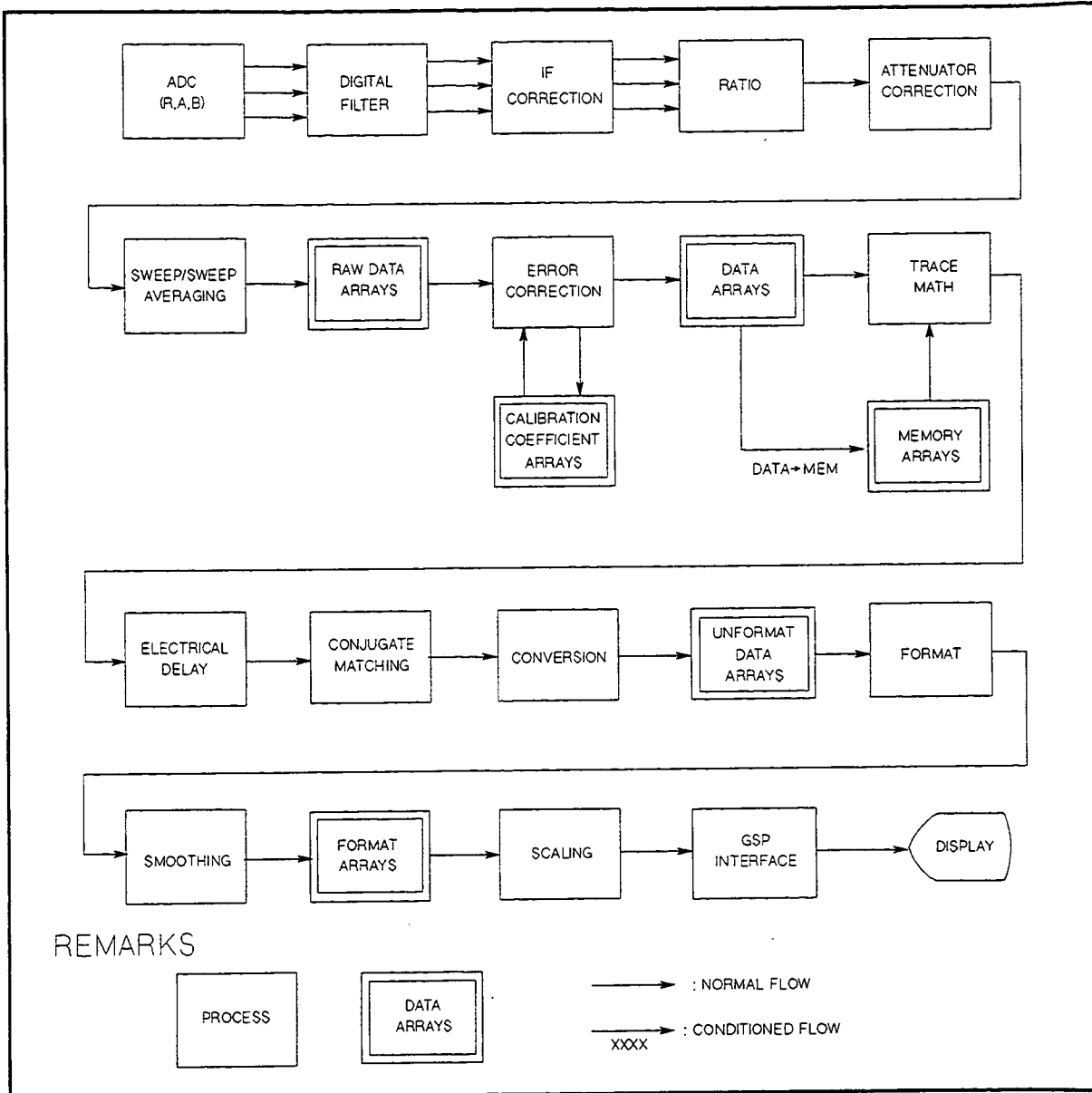

C2001002

Figure 1-2. Data Processing Flow Diagram

Note



While only a single flow path is shown, two identical paths are available, corresponding to channel 1 and channel 2. When the channels are uncoupled, each channel can be independently controlled, so that the data processing operations for one are different from the other.

Data Processing

Processing Details

The ADCs

The ADCs at every port (R, A, and B) convert an analog signal, which is already down-converted to a fixed low frequency IF, into digital data. Refer to “**MEAS** KEY” in Chapter 6 for more information on inputs.

Digital Filter

The digital filter detects the IF signal by performing a discrete Fourier transform (DFT) on the digital data. The samples are converted into complex number pairs, real plus imaginary, $R+jI$, which represent both the magnitude and phase of the IF signal. If the Bdc input is selected, the imaginary part of the pair is set to zero. The filter shape can be altered by selecting the IF bandwidth from among 2, 20, 200, 1 k, and 4 kHz, which is a highly effective technique for noise reduction. Refer to “**AVG** KEY” in Chapter 6 for information on different noise reduction techniques.

IF Correction

This process digitally corrects for frequency response errors in the analog down conversion path.

Ratio Calculations

These are performed if the selected measurement is a ratio of two inputs (e.g. A/R or B/R). This is simply a complex divide operation. If the selected measurement is absolute (e.g. A or B), no operation is performed. The R, A, and B values are also split into channel data at this point. Refer to “**MEAS** KEY” in Chapter 6 for more information.

Input Attenuator Correction

If the built-in attenuator is used, this corrects the value to be equal to what it was before being attenuated.

Sweep-to-sweep Averaging

This is one of the noise reduction techniques. This calculation involves taking the complex exponential average of up to 999 consecutive sweeps. Refer to “**AVG** KEY” in Chapter 6.

Raw Data Arrays

These store the results of all the preceding data processing operations. When full 2-port error correction is on, the raw data arrays contain all four S-parameter measurements required for accuracy enhancement. When the channels are uncoupled (coupled channels OFF), there may be as many as eight raw data arrays. These arrays are directly accessible via HP-IB, or using the internal disk drive. Note that the numbers here are still complex pairs.

Vector Error Correction (accuracy enhancement)

When a measurement calibration has been performed and correction is turned on, error correction removes repeatable systematic errors, stored in the calibration coefficient arrays, from the raw data arrays. This can vary from simple vector normalization to full 12-term error correction. Refer to Chapter 7 for details.

Data Processing

The calibration coefficient arrays themselves are created during a measurement calibration using data from the raw data arrays. These are subsequently used whenever correction is on, and are accessible via HP-IB, or using the internal disk drive.

The results of error correction are stored in the data arrays as complex number pairs. These arrays are accessible via HP-IB, or using the internal disk drive.

If the data-to-memory operation is performed, the data arrays are copied into the memory arrays. Refer to “**DISPLAY** KEY” in Chapter 6.

Trace Math Operation

This selects either the data array, memory array, or both to continue flowing through the data processing path. In addition, the complex ratio of the two (data/memory) or the difference (data–memory) can also be selected. If memory is displayed, the data from the memory arrays goes through exactly the same data processing flow path as the data from the data arrays. Refer to “**DISPLAY** KEY” in Chapter 6 for information on memory math functions.

The Delay Block (Electrical Delay)

This involves adding or subtracting a linear phase in proportion to frequency. This is equivalent to “line-stretching” or artificially moving the measurement reference plane. Refer to “**SCALE REF** KEY” in Chapter 6 for details.

Conjugate Matching

This simulates matching circuits at the input or output of the DUT in order to match the DUT to the system characteristic impedance. Parameters of the provided matching circuits will be calculated.

Conversion Transforms

Transforms S-parameter measurement data into equivalent complex impedance (Z) or admittance (Y) values, to inverse S-parameters ($1/S$), or to phase multiples of 4, 8, or 16. Refer to “Conversion Menu” in Chapter 6.

Unformat Data Arrays

This arrays hold the complex number pairs which will be converted into a scalar number in the next stage. The arrays are accessible using the internal disk drive.

Formatting

This converts the complex number pairs into a scalar representation for display, according to the selected format. This includes group delay calculations. These formats are often easier to interpret than the complex number representation. (Polar and Smith chart formats are not affected by the scalar formatting.) Note that after formatting, it is impossible to recover the complex data. Refer to “**FORMAT** KEY” in Chapter 6 for information on the different formats available and on group delay principles.

Smoothing

This is one of the noise reduction techniques, that smooths noise on the trace. When smoothing is on, each point in a sweep is replaced by the moving average value of several adjacent (formatted) points. The number of points included depends on the user defined

Data Processing

smoothing aperture. The effect is similar to video filtering. If data and memory are displayed, smoothing is performed on both data and memory traces. Refer to “**AVG** KEY” in Chapter 6 for information about smoothing.

Format Arrays

The results so far are stored in the format arrays. It is important to note that marker values and marker functions are all derived from the format arrays. Limit testing is also performed on the formatted data. The format arrays are accessible via HP-IB, or using the internal disk drive.

Scaling

These operations prepare the formatted data for display on the CRT. This is where the reference line position, reference line value, and scale calculations are performed, as appropriate to the format. Refer to “**SCALE REF** KEY” in Chapter 6.

Display Memory

The display memory stores the display image for presentation on the display. The information here includes graticules, annotation, and softkey labels - everything visible on the display. When the display is printed or plotted, the information sent to the printer or plotter is taken from display memory. Finally, the display memory data is sent to the display.

Front and Rear Panel

INTRODUCTION

This chapter describes the analyzer operation using its front panel controls, and explains the use of softkey menus. It provides illustrations and descriptions of the front panel features, the CRT display and its labels, and the rear panel features and connectors.

Analyzer functions are activated from the front panel by the operator using front panel keys or softkeys. In this manual, all front panel keys and softkey labels are shown as **Hardkey** and **Softkey**.

ACTIVE FUNCTION

The function currently activated is called the active function, and is displayed in the active entry area at the upper left of the display. As long as a function is active it can be modified with the ENTRY keypad (refer to "ENTRY BLOCK KEYS" in Chapter 4). A function remains active until another function is selected, or **ENTRY OFF** is pressed.

FRONT PANEL KEYS AND SOFTKEY MENUS

Some of the front panel keys change instrument functions directly, and others provide access to additional functions available in softkey menus. Softkey menus are lists of up to eight related functions that can be displayed in the softkey label area at the right-hand side of the display. The eight keys to the right of the CRT are the softkeys. Pressing one of the softkeys selects the adjacent menu function. This either executes the labeled function and makes it the active function, causes instrument status information to be displayed, or presents another softkey menu.

Some of the analyzer's menus are accessed directly from front panel keys, and some from other menus. For example, the stimulus menu accessed by pressing the **MENU** key presents all the stimulus functions such as sweep type, number of points, power, sweep time, and trigger. Pressing **NUMBER of POINTS** allows the required number of points per sweep to be entered directly from the number pad. The **RETURN** softkeys returns to previous menus, while **DONE** both indicates completion of a specific procedure and returns to an earlier menu.

Usually, whenever a menu changes, the present active function is cleared, unless it is an active marker function.

Front Panel Keys and Softkey Menus

Softkeys that are Joined by Vertical Lines

In cases where several possible choices are available for a function, they are joined by vertical lines. For example, in the input menu under the **MEAS** key, the available inputs and input ratios are listed: A, B, R, A/R, B/R, A/B, and only one can be selected at a time. When a selection has been made from the listed alternatives, that selection is underlined until another selection is made.

Softkeys That Toggle On or Off

Some softkey functions can be toggled ON or OFF, for example averaging, and this is indicated in the softkey label. The current state, ON or OFF, is capitalized in the softkey label.

Example:

AVERAGING ON off

The word ON is capitalized, showing that averaging is currently ON.

AVERAGING on OFF

The word OFF is capitalized, showing that averaging is currently OFF.

Softkeys that Show Status Indications in Brackets

Some softkey labels show the current status of a function in brackets. These include simple toggle functions and status-only indicators. An example of a toggled function is the **PLOT SPEED [FAST]** or **PLOT SPEED [SLOW]** softkey. The **IF BW** softkey is an example of a status-only indicator, where the selected value of the IF bandwidth is shown in brackets in the softkey label.

Function Key Blocks

The front panel keys that provide access to softkey menus are grouped into the STIMULUS, RESPONSE, and INSTRUMENT STATE function blocks.

Stimulus Block

The stimulus block keys and softkey menus control all the functions of the test signal source.

Response Block

The response block keys and softkey menus control the measurement and display functions specific to the active channel.

Instrument State Block

The instrument state block keys and softkey menus control channel-independent system function such as printing and plotting, save and recall, and HP-IB controller mode. In addition, major features such as limit testing, and Instrument BASIC (Option 002) are accessed under the **SYSTEM** key.

Instrument BASIC allows BASIC program entry using a full keyboard, to automate DUT measurement. Instrument BASIC may also be configured to run automatically at power on. This function also allows the operator to control external HP-IB instrument from the analyzer. *Using HP Instrument BASIC with HP 8751A* describes this feature.

HP-IB Control

The functions accessible from the front panel can also be accessed remotely by an external controller using HP-IB, or the Instrument BASIC function (Option 002). Equivalent HP-IB commands are available for most of the front panel keys and softkey menu selections. The HP-IB programming command equivalent to each front panel and softkey function is provided in parentheses after the first reference. Additional information about HP-IB programming is provided in *HP-IB Programming Manual*.

Information on Keys and Softkeys

The following chapters describe all the front panel keys and softkey menus in detail. The purpose and use of each function is detailed, together with expected indications and results, allowable values, and possible limitations. This information is presented in function block order. Each function block is illustrated and described in general terms. This is followed by information about each front panel key in the function block, together with a map and description of all the menus accessed from that key. Each menu is illustrated, and each softkey function in each menu is explained in detail. A complete map of the softkey menu structure is provided in Appendix B at the end of this reference, together with an alphabetical index.

FRONT PANEL FEATURES

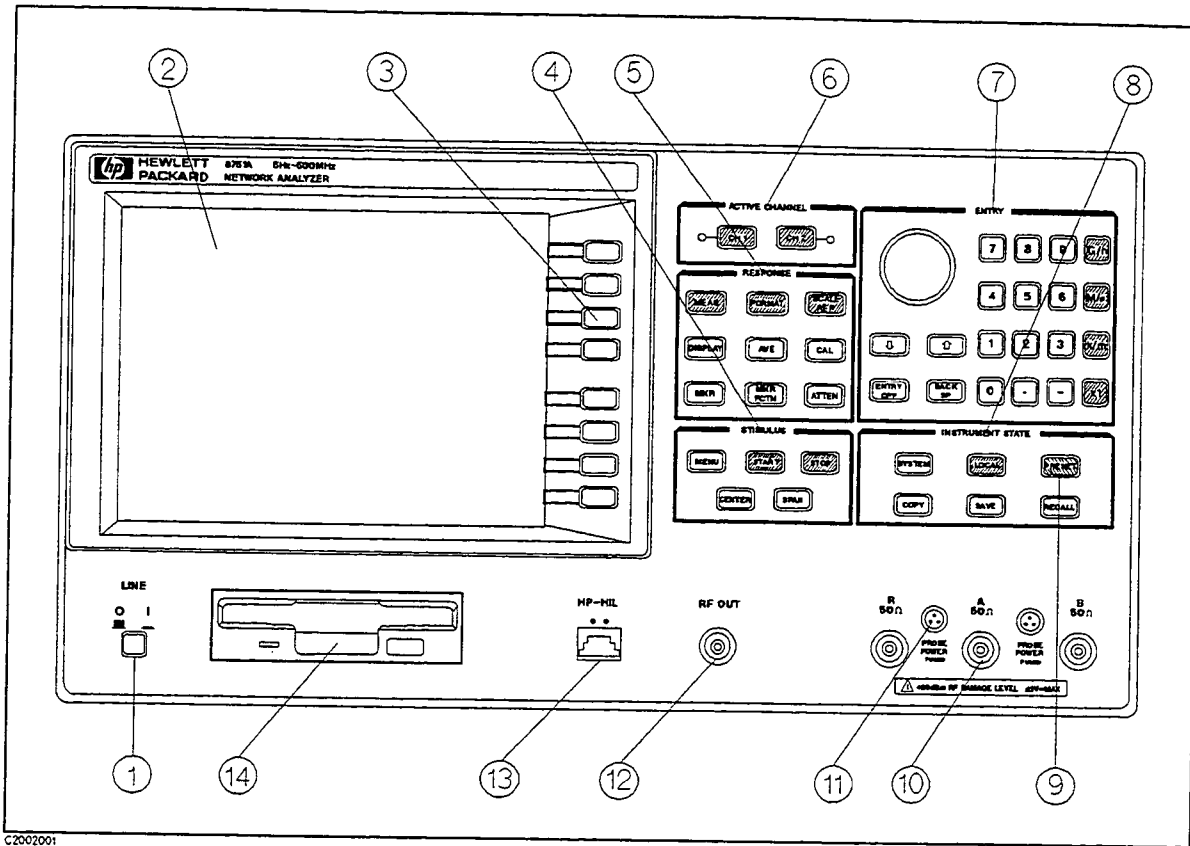

Figure 2-1. HP 8751A Front Panel

Figure 2-1 illustrates the following features and function blocks of the analyzer front panel. These features are described in more detail in this and subsequent chapters.

Caution



A properly grounded AC outlet is mandatory when operating the analyzer. Operating the instrument with an improperly grounded or floating ground prong ***WILL DAMAGE THE INSTRUMENT!***

1. **LINE switch.** This controls AC power to the analyzer. 1 is ON, 0 is OFF.
2. **CRT display.** This is used for display of data traces, measurement annotation, softkey labels, and other information. The display is divided into specific information areas, illustrated in Figure 2-2.
3. **Softkeys.** These keys expand the capabilities of the analyzer with additional functions beyond those of the front panel keys. They provide access to menu selections displayed on the CRT.
4. **STIMULUS function block.** The keys in this block control the RF signal from the analyzer's source, and other stimulus functions.
5. **RESPONSE function block.** The keys in this block control the measurement and display functions of the active display channel.

6. **ACTIVE CHANNEL keys.** These keys select the active channel from two independent display channels. Any functions then entered apply to this active channel.
7. **The ENTRY block** includes the knob, the step \uparrow \downarrow keys, and the number pad. These are for entering numerical data and controlling the marker.
8. **INSTRUMENT STATE function block.** These keys control channel-independent system functions such as the following:
 - Limit testing (under the **SYSTEM** key).
 - Real time clock setting (under the **SYSTEM** key).
 - Instrument BASIC (Option 002) (under the **SYSTEM** key).
 - Changing the HP-IB addresses used by the analyzer when controlling external devices (printer, plotter). This done through the **LOCAL** key.
 - Printing and plotting (under the **COPY** key).
 - Save/Recall, under their respective keys.
9. **PRESET key.** This key returns the instrument to a known standard preset state from any step of any manual procedure. A complete listing of the instrument preset conditions is provided in Appendix A.
10. **Network analyzer inputs R, A, and B.** These receive input signals from a test set, source, or device under test. Input R is used as the reference input, Input B is also used as the dc voltage input. The input impedance of each input is 50 Ω .
11. **PROBE POWER connector.** This connector (fused inside the instrument) supplies power to an active probe for in-circuit measurements of AC circuits. Applicable active probes are described in the General Information section.
12. **RF OUT connector.** This connects the RF output signal from the analyzer's internal source to a test set or power splitter. The output impedance at this connector is 50 Ω .
13. **HP-HIL connector.** This connects the keyboard to use Instrument BASIC.
14. **Built-in Flexible Disk Drive.** This stores the measurement data, instrument status, list sweep tables, and Instrument BASIC programs. The applicable disk formats are LIF (logical interchange format) and DOS format.

CRT DISPLAY

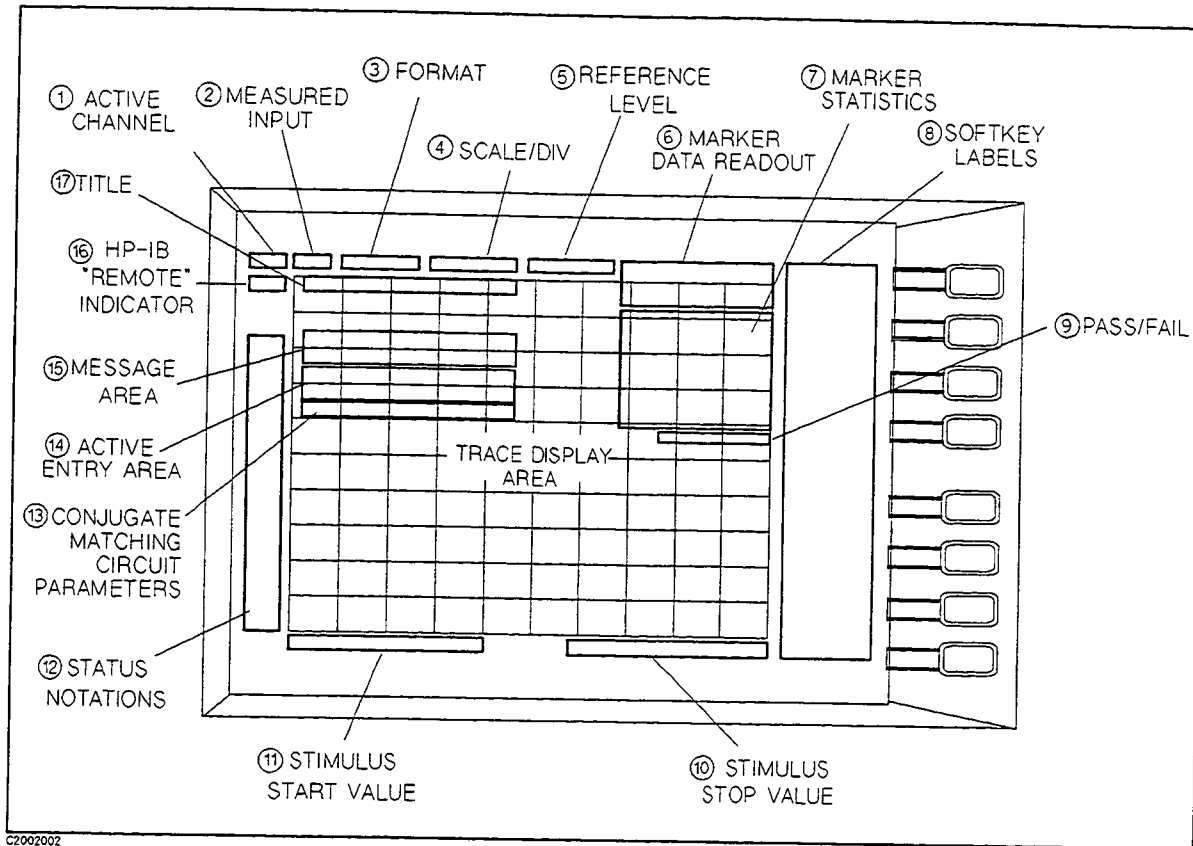

Figure 2-2. CRT Display (Single Channel, Cartesian Format)

The CRT displays the grid on which the measurement data is plotted, the currently selected measurement traces, and other information describing the measurement. Figure 2-2 illustrates the locations of the different CRT information labels, described below.

In addition to the full-screen display shown in Figure 2-2, a split display is available, as described under “**DISPLAY** KEY” in Chapter 6. In this case, information labels are provided for each half of the display.

Several different display formats for different measurements are illustrated and described in “**FORMAT** KEY” in Chapter 6.

The screen can also be used as the Instrument BASIC display. Instrument BASIC uses a full-screen display or a half-screen display below the graticule display as a text screen, and uses all of the screen as a graphics screen.

The following describe the information labels in detail.

1. **Active Channel** is the number of the current active channel, selected with the **ACTIVE CHANNEL** keys. If dual channel is ON with an overlaid display, both channel 1 and channel 2 appear in this area.

2. **Measured Input(s)** shows the S-parameter, input, or ratio of inputs currently measured, as selected using the **MEAS** key. The current display memory status is also indicated in this area.
3. **Format** is the display format selected using the **FORMAT** key.
4. **Scale/Div** is the scale selected using the **SCALE REF** key, in units appropriate to the current measurement.
5. **Reference Level** is the value of a reference line in Cartesian formats or the outer circle in polar formats, selected using the **SCALE REF** key. However the reference line is invisible, it is indicated by a small triangle adjacent to the graticule at the left.
6. **Marker Data Readout** are the values of the active marker, in units appropriate to the current measurement. Refer to Chapter 8.
7. **Marker Statistics, Width Value** are statistical marker values determined using the menus accessed with the **MKR FCTN** key. Refer to Chapter 8 .
8. **Softkey Labels** are menu labels displayed on the CRT that redefine the function of the softkeys immediately to the right of the CRT.
9. **Pass/Fail** are used for limit testing using limit lines. Refer to "LIMIT LINE AND LIMIT TESTING" in Chapter 9.
10. **Stimulus Stop Value** is the stop frequency of the source in frequency domain measurements, or the upper limit of a power sweep. When the stimulus is in center/span mode, the span is shown in this space. The stimulus values can be blanked, as described under "**DISPLAY** KEY" in Chapter 6.
11. **Stimulus Start Value** is the start frequency of the source in frequency domain measurements, or the lower power value in power sweep. When the stimulus is in center/span mode, the center stimulus value is shown in this space.

(For power sweep measurements, the CW frequency is displayed centered between the start and stop power values.)

CRT Display

12. **Status Notations** is the current status of various functions for the active channel. The following notations are used:
- | | |
|-----|--|
| Avg | Sweep-to-sweep averaging is ON. The averaging count is shown immediately below (see “ AVG KEY” in Chapter 6). |
| Cor | Error correction is ON (see Chapter 7). |
| C? | Stimulus parameters have changed, and interpolated error correction is ON (see “ CAL Key” in Chapter 7). |
| C! | Stimulus parameters have changed, and interpolated error correction is not available (see “ CAL Key” in Chapter 7). |
| C2 | Two-port error correction is ON (see Chapter 7). |
| C2? | Two-port error correction is ON, but stimulus parameters have changed, and interpolated error correction is ON. |
| C2! | Two-port error correction is ON, but stimulus parameters have changed, and interpolated error correction is not available. |
| Del | Electrical delay, port extension, or phase offset has been added or subtracted (see “ SCALE REF KEY” in Chapter 6). |
| Cnj | Conjugate Matching is ON. |
| Ext | Waiting for an external trigger. |
| Hld | Hold sweep (see “Trigger Menu” in Chapter 5). |
| msH | “msH” indicates that the mechanical switch hold mode is engaged. The user has selected a mode of operation which would cause repeated switching of either the test port transfer switch in S-parameter test set or the mechanical switch in the analyzer. For more information refer to Chapter 5. |
| Svc | A service mode is turned on. If this notation is shown, the measurement data will be out of specifications. (Refer to <i>Maintenance Manual</i> .) |
| P↓ | Source power has been automatically set to minimum due to overload at the input (see “Power Menu” in Chapter 5). |
| Smo | Trace smoothing is ON (see “ AVG KEY” in Chapter 6). |
| * | Source parameters changed: measured data in doubt until a complete fresh sweep has been taken. |
13. **Conjugate Matching Circuit Parameters** are the derived parameters by the conjugate matching function. Refer to “Conjugate Matching Menu” in Chapter 6.
14. **Active Entry Area** displays the active function and its current value.
15. **Message Area** displays prompts or error messages.
16. **HP-IB REMOTE Indicator** displays “RMT” when the analyzer is in the remote state.
17. **Title** is a descriptive alpha-numeric string title defined by the user and entered as described at “Title Menu” in Chapter 6 under “**DISPLAY** KEY” in Chapter 6.

Note

The information provided here applies to Cartesian display formats. In polar and Smith chart display formats the labeling may differ.

REAR PANEL FEATURES AND CONNECTORS

Figure 2-3. HP 8751A Rear Panel

Figure 2-3 illustrates the features and connectors of the rear panel, described below. Requirements for input signals to the rear panel connectors are provided in the General Characteristics table of the General Information and Specifications section.

1. **HP-IB connector.** This connects the analyzer to an external controller and other instruments in an automated system. This connector is also used when the analyzer itself is the controller of compatible peripherals. Refer to Chapter 12.
2. **TEST SET INTERCONNECT.** This connects the analyzer to an HP 87511A,B S-parameter test set using the interconnect cable supplied with the test set. The test set is then fully controlled by the analyzer. The HP 87512A,B transmission/reflection test kits do not use this interconnection.
3. **I/O port connector.** See Appendix C for complete information.

Rear Panel Features and Connectors

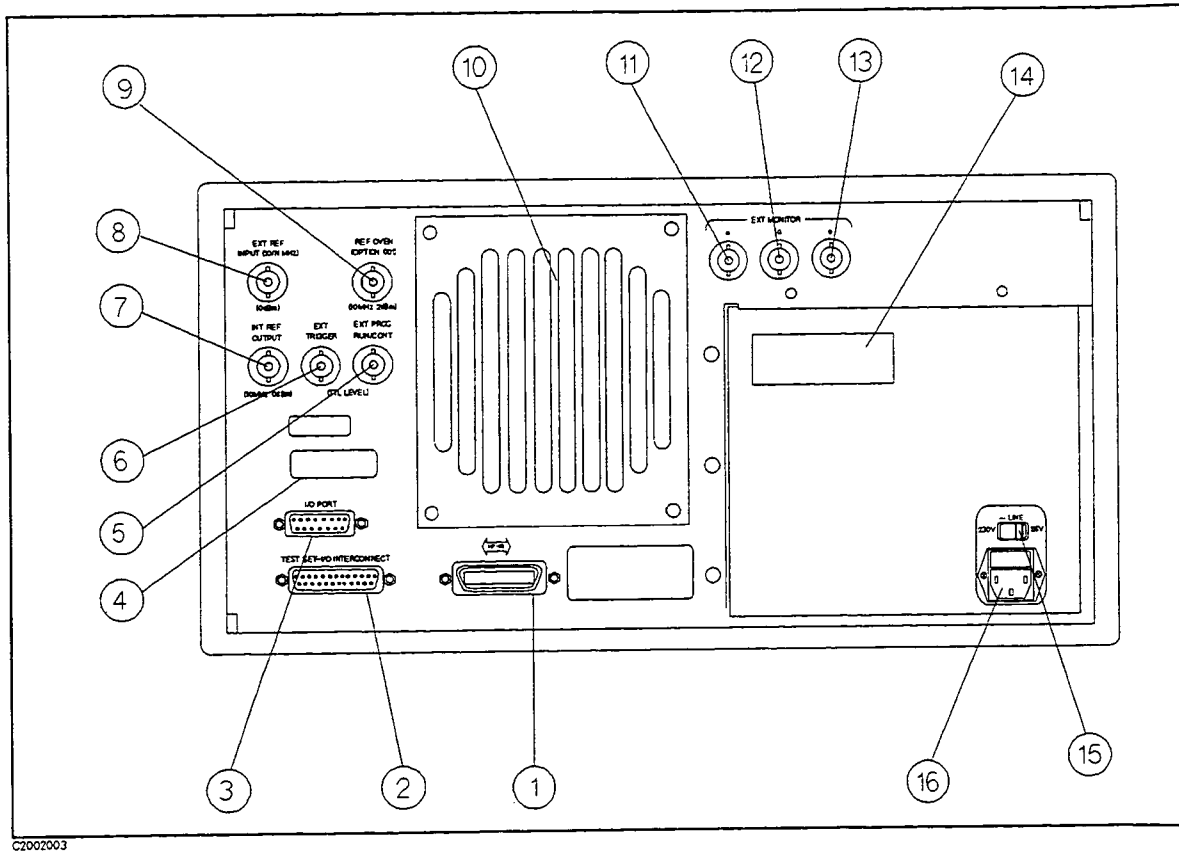
4. **Serial number plate.** For information about serial numbers, refer to "Instruments Covered by This Manual" in the General Information.
5. **EXT PROG RUN/CONT connector.** This externally triggers RUN or CONT of the Instrument BASIC program. At the positive-going edge of a pulse more than 20 μ sec wide in the LOW state will trigger RUN or CONT. The signal is TTL-compatible.
6. **EXT TRIGGER connector.** This triggers a measurement sweep. At the positive-going edge of a pulse with more than 20 μ sec wide in the LOW state will start a measurement. The signal is TTL-compatible. To use this connector, set the trigger mode to external using softkey functions (see "Trigger Menu" in Chapter 5).
7. **INT REF OUTPUT connector.** This connects a frequency reference input of an external instrument to phase lock it to the HP 8751A.
8. **EXT REF INPUT connector.** This inputs a frequency reference signal to phase lock the analyzer to an external frequency standard for increased frequency accuracy.

When the HP 8751A is equipped with the external oven (Option 001), this connector must be connected to REF OVEN connector.

The external frequency reference feature is automatically enabled when a signal is connected to this input. When the signal is removed, the analyzer automatically switches back to its internal frequency reference.
9. **REF OVEN (Option 001) connector** connects to the EXT REF INPUT connector, when Option 001 is installed. Option 001 improves the frequency accuracy and stability of the analyzer.
10. **Fan.** This provides forced-air cooling for the analyzer.
11. **RED connector.**
12. **GREEN connector.**
13. **BLUE connector.** The red, green, and blue video output connectors provide analog red, green, and blue video signals which can drive an external color monitor such as the HP 35741B or monochrome monitor such as the HP 35731B. Other analog multi-sync monitors can be used if they are compatible with the analyzer's 25.5 kHz scan rate and video levels: 1 Vp-p, 0.7 V = white, 0 V = black, -0.3 V sync, sync on green.

A monochrome display with applicable input specifications can also be connected to the GREEN connector.
14. **Safety warnings.**
15. **Line voltage selector switch.** Refer to "Line Voltage" in the User's Guide.
16. **Power cord receptacle, with fuse.**

Active Channel Block

ACTIVE CHANNEL KEYS

The analyzer has two digital channels for independent measurement and display of data. Two different sets of data can be measured simultaneously, for example the reflection and transmission characteristics of a device, or one measurement with two different frequency spans. The data can be displayed separately or simultaneously, as described below.

The HP-IB programming command is shown in parenthesis following the key or softkey.

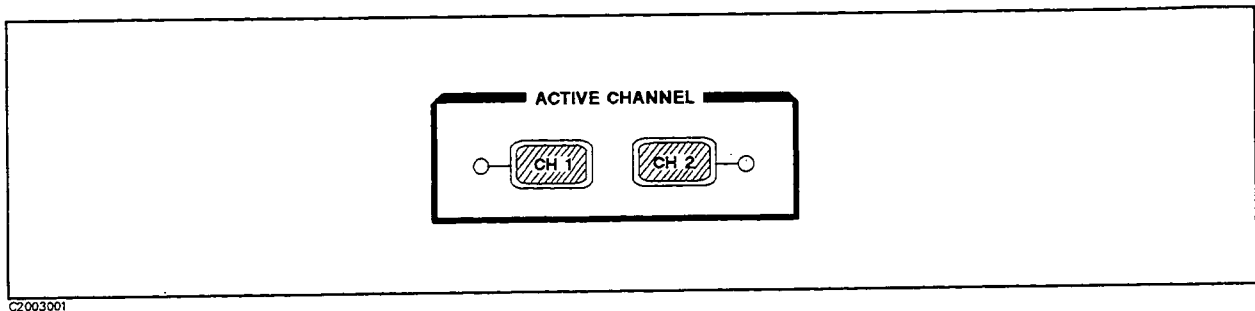

C2003001

Figure 3-1. Active Channel Keys

The **CH 1** (CHAN1) and **CH 2** (CHAN2) keys illustrated in Figure 3-1 select which channel is the *active channel*. This is the channel currently controlled by the front panel keys, and its trace and data annotations are displayed on the display. All channel specific functions selected apply to the active channel. The current active channel is indicated by an amber LED adjacent to the corresponding channel key.

The analyzer has dual trace capability, so that both the active and inactive channel traces can be displayed, either overlaid or on separate graticules (split display). The dual channel and split display features are available in the display menus. Refer to Chapter 6 for illustrations and descriptions of the different display capabilities.

Stimulus values can be coupled or uncoupled between the two channels, independent of the dual channel and split display functions. Refer to "**MENU** KEY" in Chapter 5 for a listing of the source values that are coupled in stimulus coupled mode.

Another coupling capability is coupled markers. Measurement markers can have the same stimulus values for the two channels, or they can be uncoupled for independent control in each channel. Refer to Chapter 8 for more information about markers.

Entry Block

ENTRY BLOCK KEYS

The ENTRY block, illustrated in Figure 4-1, provides the numeric and units keypad, the knob, and the step keys. These are used in combination with other front panel keys and softkeys to modify the active entry, to enter or change numeric data, and to change the value of the active marker. In general the keypad, knob, and step keys can be used interchangeably.

Before a function can be modified, it must be made the active function by pressing a front panel key or softkey. It can then be modified directly with the knob, the step keys, or the digits keys and a terminator, as described below.

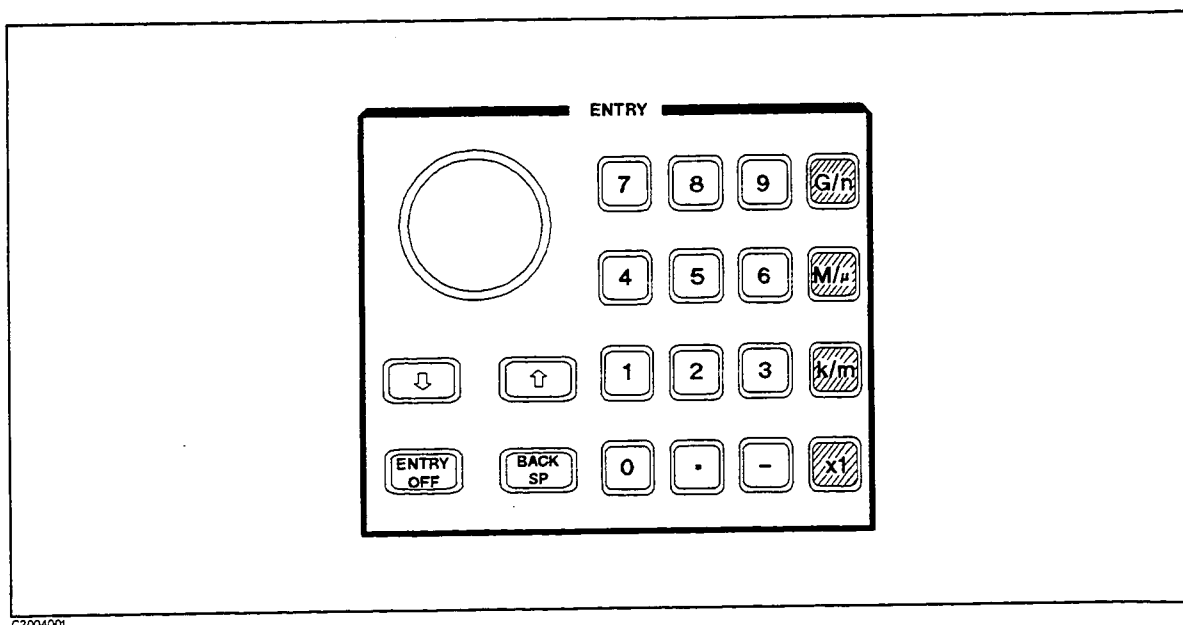

Figure 4-1. Entry Block

The numeric keypad selects digits, decimal point, and minus sign for numerical entries. A units terminator is required, as described below. The HP-IB programming command is shown in parenthesis following the key or softkey.

The units terminator keys are the four keys in the right-hand column of the keypad. These specify units of numerical entries from the keypad and at the same time terminate the entries. A numerical entry is incomplete until a terminator is supplied, and this is indicated by the data entry arrow “←” pointing at the last entered digit in the active entry area. When the units terminator key is pressed, the arrow is replaced by the units selected. The units are abbreviated on the terminator keys as follows:

Entry Block Keys

G/n (G, N, KEY 43)	Giga/nano ($10^9 / 10^{-9}$)
M/μ (MA, U, KEY 42)	Mega/micro ($10^6 / 10^{-6}$)
k/m (K, M, KEY 41)	kilo/milli ($10^3 / 10^{-3}$)
x1 (KEY 40)	basic units: dB, dBm, degrees, seconds, Hz, or dB/GHz (may be used to terminate unitless entries such as averaging factor). No HP-IB commands are required.

Note

The suffix unit MHZ is a special case which should not be confused with MAHZ (megahertz) or mHZ (microhertz).



The knob adjusts continuously to current values for various functions such as scale, reference level, and others. If a marker is turned on, and no other function is active, the knob can adjust the marker position. Values changed by the knob are effective immediately, and require no units terminator.

The step keys **↓** (KEY 24) and **↑** (KEY 25) step the current value of the active function up or down. The steps are predetermined and cannot be altered. No units terminator is required with these two keys.

ENTRY OFF (KEY 26) clears and turns off the active entry area, as well as any displayed prompts, error messages, or warnings. Use this function to clear the display before plotting. This key also prevents changing of active values by accidentally moving the knob. The next selected function turns the active entry area back on.

BACK SPACE key (KEY 27) deletes the last entry, or the last digit entered from the numeric keypad.

Stimulus Function Block

INTRODUCTION

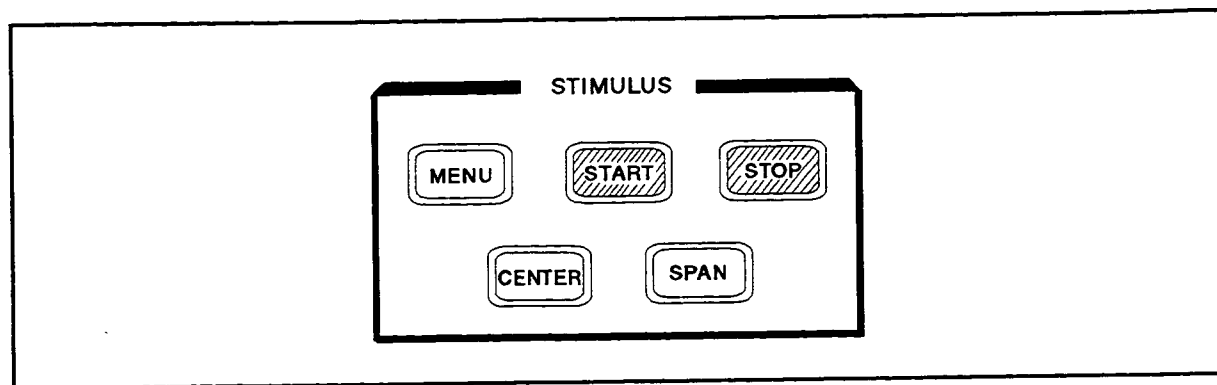

C2005.001

Figure 5-1. Stimulus Function Block

The stimulus function block keys and associated menus define and control the source RF output signal to the device under test. The source signal can be swept over any portion of the instrument's frequency and power range. The menus set all other source characteristics such as sweep time and resolution, source RF power level, the number of data points taken during the sweep, and S-parameter test set attenuation.

Note

Refer to the Specifications in the *GENERAL INFORMATION* for some power sweep range restrictions.

The HP-IB programming command is shown in parenthesis following the key or softkey.

MECHANICAL SWITCH HOLD

Output Power Switch

A mechanical switch in the analyzer sets the output power level. When list sweep or the dual channel mode is ON and the power levels of each segment or channel are different by more than 35 dB, measurement configuration requires continuous switching. But to avoid premature wearing out of the output power switch, continuous switching is not allowed, and the notation "msH" is displayed at the left of the screen. (If averaging is ON, the hold mode will not engage until the specified number of sweeps are completed.)

Test Port Transfer Switch

An S-parameter test set can only send power to one test port at a time. A mechanical transfer switch in the test set sends power to either port 1 or port 2. To avoid premature wearing out of the transfer switch, measurement configurations requiring continuous switching are not allowed. The following examples explain how the analyzer prevents continuous switching:

- A full two-port calibration requires all four S-parameters be measured for each sweep. This would require the transfer switch to engage twice each sweep. To prevent continuous switching, only the first measurement uses the transfer switch to measure all four S-parameters. Subsequent sweeps do not use the switch and only two S-parameters are measured. The **MEASURE RESTART** and **NUMBER of GROUPS** softkeys or computer control can override this protection feature and allow measurement of all four S-parameters.
- When port 1 and port 2 are driven by different channels and dual channel display is turned on, the transfer switch would switch repeatedly between channels. To prevent continuous switching, the analyzer automatically engages the test set hold mode. (The status annotation "msH" appears on the left side of the display.) If averaging is ON, the hold mode will not engage until the specified number of sweeps are completed. The **MEASURE RESTART** and **NUMBER of GROUPS** softkeys or computer control can override this protection feature and allow switching to occur.

Note



When the HP 8751A is connected to a S-parameter test set which uses a solid-state transfer switches, continuous switching is allowed.

MEASURE RESTART and **NUMBER of GROUPS** Softkeys

These softkeys allow measurements which demand repetitive switching of the mechanical transfer switch. Use these softkeys with caution, repetitive switching will cause premature wearing out of the switches.

- **MEASURE RESTART** causes one measurement to occur.
- **NUMBER of GROUPS** causes a specified number of measurements to occur.

These softkeys are explained in detail later in this chapter.

START, STOP, CENTER, AND SPAN KEYS

The HP-IB programming command is shown in parenthesis following the key or softkey.

START (STAR)

STOP (STOP)

CENTER (CENT)

SPAN (SPAN)

These keys define the frequency range or power range of the stimulus. The range can be expressed as either start/stop or center/span. When one of these keys is pressed, its function becomes the active function. The value is displayed in the active entry area and can be changed with the knob, step keys, or numeric keypad. Current stimulus values for the active channel are also displayed along the bottom of the graticule. Frequency values can be a blank for security purposes, using the display menus.

The preset stimulus mode is frequency, and the start and stop stimulus values are set to 5 Hz (or 100 kHz when an S-parameter test set is connected) and 500 MHz respectively. In power sweep, the stimulus value is in dBm.

Because the display channels are independent, the stimulus signals for the two channels can be uncoupled and their values set independently. The values are then displayed separately on the display if the analyzer is in dual channel display mode. In the uncoupled mode with dual channel display the analyzer takes alternate sweeps to measure the two sets of data. Channel stimulus coupling is explained in this chapter, and dual channel display capabilities are explained in Chapter 6 .

MENU Key

MENU KEY

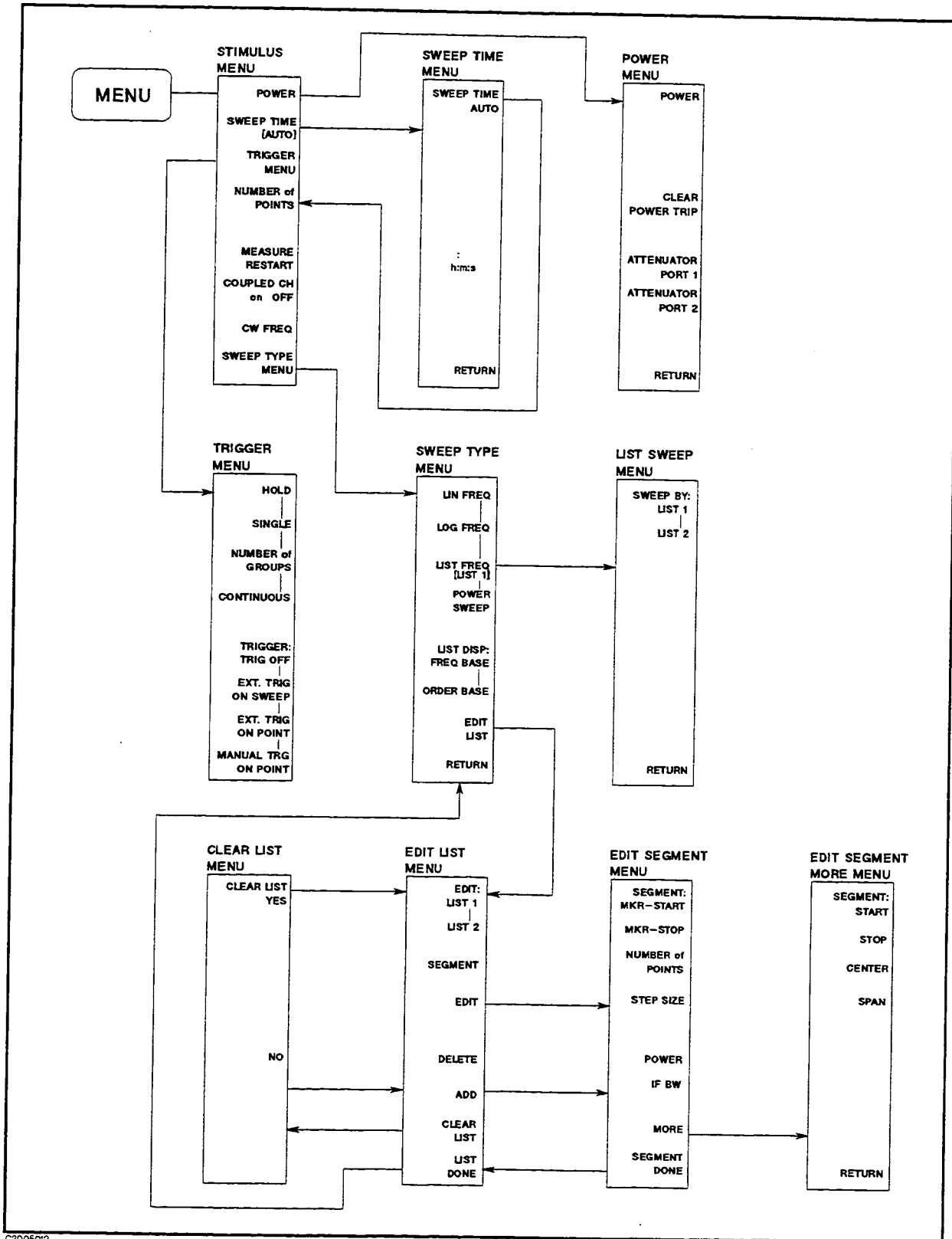

C2005012

Figure 5-2. Softkey Menus Accessed from the MENU Key

5-4 Stimulus Function Block

The HP-IB programming command is shown in parenthesis following the key or softkey.

The **MENU** (KEY 19) key provides access to the series of menus illustrated in Figure 5-3, which define and control all stimulus functions other than start, stop, center, and span. When the **MENU** key is pressed, the stimulus menu is displayed. This in turn provides access to the other softkey menus. The functions available in these menus are described in the following paragraphs.

Stimulus Menu

The stimulus menu specifies the number of measurement points per sweep, and CW frequency. It includes the capability to couple or uncouple the stimulus functions of the two display channels, and the measurement restart function. In addition, it leads to other softkey menus that define power level, sweep time, trigger type, and sweep type. The individual softkey functions of the stimulus menu are described below.

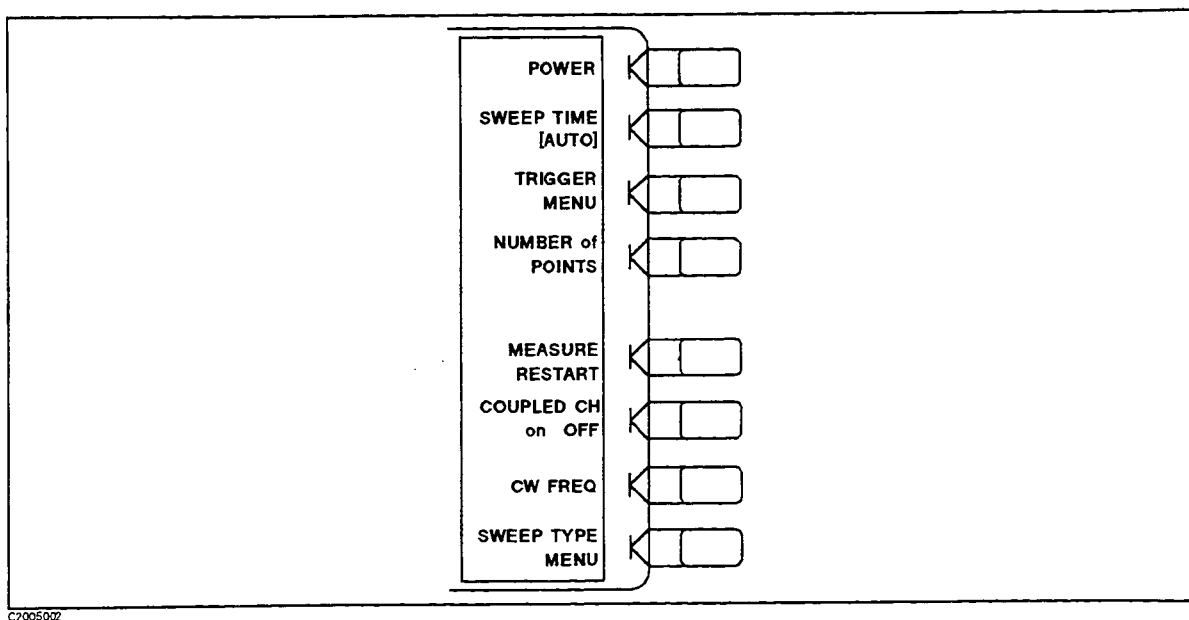

Figure 5-3. Stimulus Menu

POWER (POWE) makes power level the active function and presents the power menu, which sets the output power level. The allowable power range is -50 dBm to $+15$ dBm with a maximum single sweep power range of 35 dB.

SWEEP TIME [] (SWET) makes sweep time value the active function and presents the sweep time menu, which toggles between automatic and manual sweep time.

TRIGGER MENU presents the trigger menu, which selects the type of the sweep trigger.

NUMBER of POINTS (POIN) selects the number of data points per sweep. Using fewer points allows a faster sweep time but the displayed trace shows less horizontal detail. Using more points gives greater data density and improved trace resolution, but slows the sweep.

The possible values that can be entered for number of points are 2 through 801 with a step value of 1. The number of points can be different for the two channels if the stimulus values are uncoupled.

MENU Key

In list frequency sweep, the number of points displayed is the total number of frequency points for the defined list (see “Sweep Type Menu” in this chapter).

MEASURE RESTART (REST) aborts the sweep in progress, then restarts the measurement. This can update a measurement following an adjustment of the device under test. When a full two-port calibration is in use, the **MEASURE RESTART** key will initiate another update of both forward and reverse S-parameter data. This softkey will also override the test set hold mode, which inhibits continuous switching of the mechanical switch. The measurement configurations which cause this are described in “MECHANICAL SWITCH HOLD” at the beginning of this chapter. This softkey will override the test set hold mode for one measurement.

If the analyzer is taking a number of groups (see “Trigger Menu” in this chapter), the sweep counter is reset at 1. If averaging is ON, **MEASURE RESTART** resets the sweep-to-sweep averaging and is effectively the same as **AVERAGING RESTART**.

If the sweep trigger is in the **HOLD** mode, **MEASURE RESTART** executes a single sweep. If **DUAL CHAN** is ON (screen displays both measurement channels), **MEASURE RESTART** executes a single sweep to both channels even if **COUPLED CH** is OFF.

COUPLED CH on OFF (COUCON, COUCOFF) toggles the channel coupling of stimulus values. With **COUPLED CH ON** (the preset condition), both channels have the same stimulus values (the inactive channel takes on the stimulus values of the active channel).

In the stimulus coupled mode, the following parameters are coupled:

- Frequency
- Number of points
- Source power level
- Number of groups
- IF bandwidth
- Sweep time
- Trigger type
- Sweep type
- List sweep table

If both channels have the same input parameter such as S_{11} or A/R, the following parameters are also coupled:

- Correction mode
- Calibration coefficient

The following parameters are always common to both channels, even if the stimulus mode is not coupled.

- External trigger mode
- Power trip (Refer to “Power Menu”)
- Input R, A, and B attenuator
- Calibration kit type and data

The following parameters are always set separately for each channel, even if the stimulus mode is coupled.

- Measurement parameter
- Display Format

- Title (on/off)
- Memory trace (on/off)
- Scale reference value
- Electrical delay
- Phase offset
- Conjugate matching (on/off, parameter)
- Averaging (on/off, factor)
- Smoothing (on/off, factor)

Coupling of stimulus values for the two channels is independent of **DUAL CHAN on OFF** in the display menu and **MARKERS: UNCOUPLED** in the marker mode menu. **COUPLED CH OFF** becomes an alternate sweep function when dual channel display is on: in this mode the analyzer alternates between the two sets of stimulus values for measurement of data and both are displayed.

CW FREQ (CWFREQ) sets the frequency for power sweep.

SWEEP TYPE MENU presents the sweep type menu, where one of the available types of stimulus sweep can be selected.

Power Menu

The power menu sets the output power level of the source.

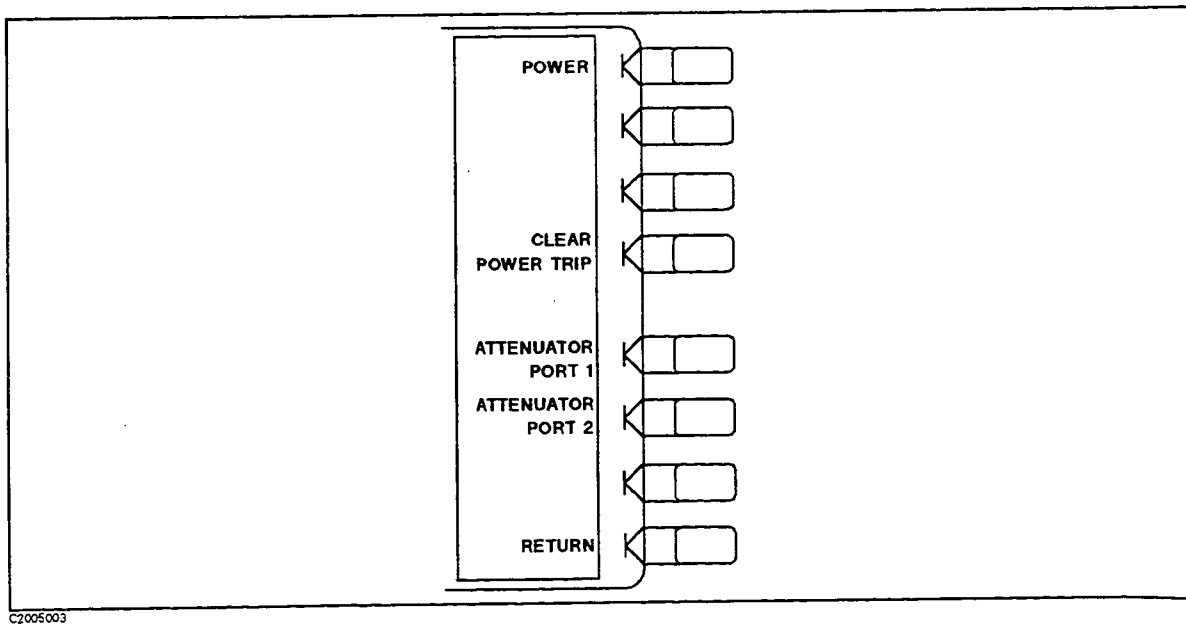

Figure 5-4. Power Menu

POWER (POWE) makes power level the active function and sets the RF output power level of the analyzer's internal source. The allowable range is -50 dBm to $+15$ dBm. The analyzer will detect an input power overload at any of the three receiver inputs, and automatically reduces the output power of the source down several dBm. This is indicated with a message. In addition, the power trip is set, and the annotation "P↓" appears at the left side of the display.

MENU Key

When this occurs, reset the power to a lower level, and press **CLEAR POWER TRIP** (see below) to turn the power trip off.

CLEAR POWER TRIP (CLEPTRIP) turns off the power trip function. Power trip is a reduced power state triggered by a power overload. It forces the source output power down several dBm regardless of the user-specified power level. The trip is set automatically whenever a power overload is detected on an input channel. When trip is ON, the annotation "P↓" appears in the status notation area of the display.

ATTENUATOR PORT 1 (ATTP1) and **ATTENUATOR PORT 2** (ATTP2)

Note



These functions are for some S-parameter test sets with a programmable attenuator (e.g. HP 85046A/B) only. No warning is given if no test set is present, or if the test set has no programmable attenuator (as in the HP 87511A/B S-parameter Test Set).

These control the attenuation at port 1 and port 2 of an S-parameter Test Set with attenuator connected to the analyzer. The attenuator range is 0 to 70 dB, controllable in 10 dB steps.

Note



The analyzer does not allow port 1 and 2 to be set to different attenuator values. This is because the same attenuator is used for both ports, and is mechanically switched between them. To prevent premature wearing out, continuous switching of attenuator values between ports is not allowed.

RETURN goes back to the stimulus menu.

Sweep Time Menu

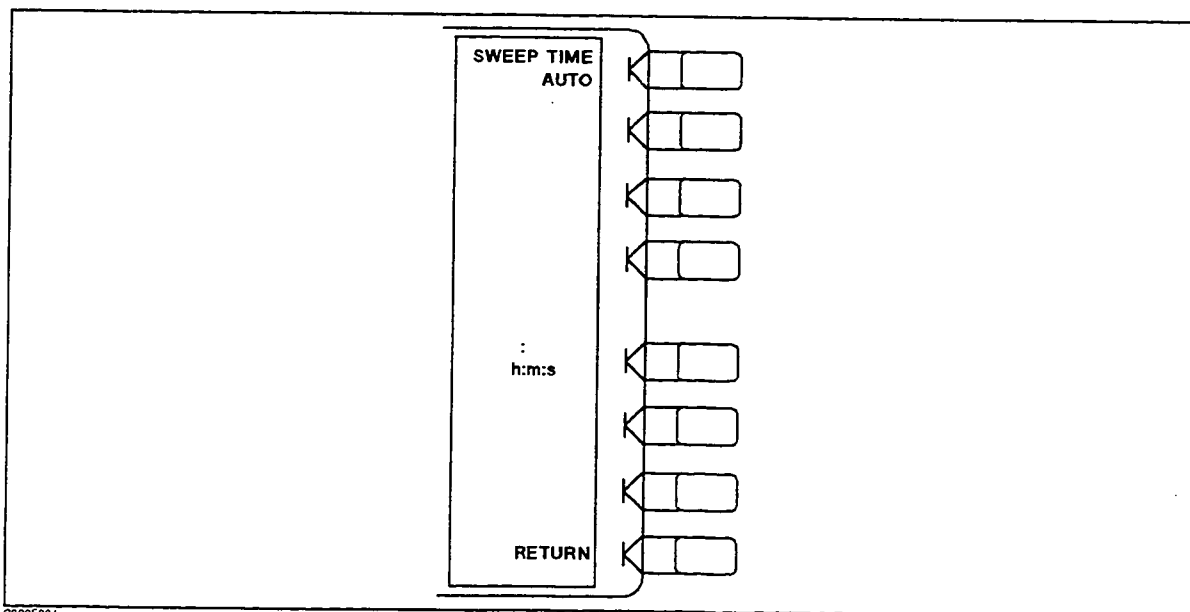

C2005004

Figure 5-5. Sweep Time Menu

SWEEP TIME AUTO (SWETAUTO) selects the proper sweep time automatically. The following explains the difference between automatic and manual sweep time:

- *Manual Sweep Time.* As long as the selected sweep speed is within the capability of the instrument, it will remain fixed, regardless of changes to other measurement parameters. If the operator changes measurement parameters such that the instrument can no longer maintain the selected sweep time, the analyzer will change to the best sweep time possible. Manual mode is turned on by entering a sweep time.
- *Auto Sweep Time.* Auto sweep time continuously maintains the fastest sweep speed possible with the selected measurement parameters to satisfy the specifications. Auto sweep time is turned on by pressing **SWEEP TIME AUTO** (SWETAUTO) when manual sweep is on.

Sweep time refers only to the time that the instrument is sweeping and taking data, and does not include the time required for internal processing of the data. A sweep speed indicator “↑” is displayed on the trace for sweep times slower than 1.0 second.

Minimum sweep time. The minimum sweep time depends on several factors. These factors are referred to as “measurement parameters” in the following paragraphs.

- The number of points selected
- IF bandwidth

The following table is a partial guide for determining the minimum sweep time. The typical values listed represent the minimum time required for a measurement with averaging off. Values are given in seconds.

Table 5-1. Minimum Sweep Time In Seconds (Typical Value)

Number Of Points	IF Bandwidth				
	4 kHz	1 kHz	200 Hz	20 Hz	2 Hz
11	4.4 m	11 m	67.1 m	583 m	7.485
51	20.4 m	51 m	311.1 m	2.703	34.71
101	40.4 m	101 m	616.1 m	5.3	68
201	80.4 m	201 m	1.196	10.65	136
401	160.4 m	401 m	2.446	21.25	272
801	320.4 m	801 m	4.886	42.45	545

:h:m:s inputs “:” for the manual sweep time entry.

RETURN goes back to the stimulus menu.

Trigger Menu

This menu selects the type of the sweep trigger.

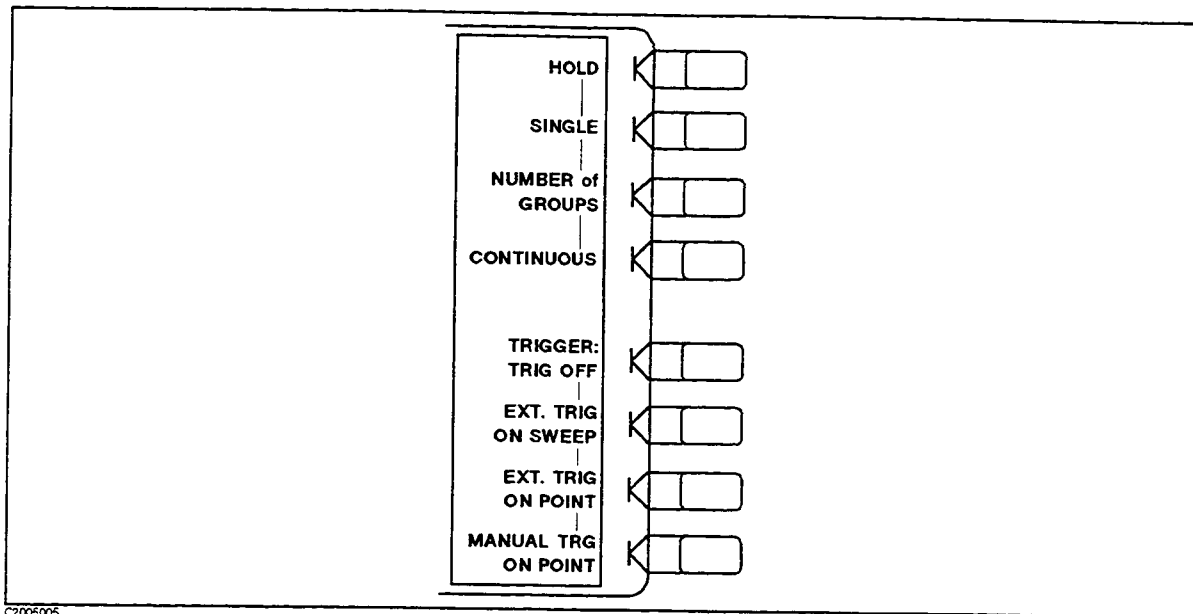

Figure 5-6. Trigger Menu

HOLD (HOLD) freezes the data trace on the display, and the analyzer stops sweeping and taking data. The notation "Hld" is displayed at the left of the graticule. If the "*" indicator is on at the left side of the display, trigger a new sweep using **SINGLE**.

SINGLE (SING) takes one sweep of data and returns to the hold mode.

NUMBER of GROUPS (NUMG) triggers a user-specified number of sweeps, and returns to the hold mode. This function can be used to override the test set hold mode, which protects the electro-mechanical switch against continuous switching. This is explained fully in "MECHANICAL SWITCH HOLD" in the beginning of this chapter.

Caution Over use of this function may cause premature wearing out of the mechanical switch.



If averaging is ON, the number of groups should be at least equal to the averaging factor selected to allow measurement of a fully averaged trace. Entering a number of groups resets the averaging counter to 1.

CONTINUOUS (CONT) is the standard sweep mode of the analyzer, in which the sweep is triggered automatically and continuously and the trace is updated with each sweep.

TRIGGER: TRIG OFF (EXTTOFF) turns off external trigger mode.

EXT. TRIG ON SWEEP (EXTTON) is used when the sweep is triggered on an externally generated signal connected to the rear panel EXT TRIGGER input. The sweep is started with a low-to-high transition of a TTL signal. If this key is pressed when no external trigger

signal is connected, the notation "Ext" is displayed at the left side of the display to indicate that the analyzer is waiting to be triggered. When a trigger signal is connected, the "Ext" notation is replaced by the sweep speed indicator "↑" either in the status notations area or on the trace. External trigger mode is allowed in every sweep mode.

EXT. TRIG ON POINT (EXTTPOIN) is similar to the trigger on sweep, but triggers each data point in a sweep.

MANUAL TRG ON POINT (MANTRIG) waits for a manual trigger for each point. Subsequent pressing of this softkey triggers each measurement. The annotation "man" will appear at the left side of the display when the instrument is waiting for the trigger to occur.

Sweep Type Menu

Four sweep types are available:

- Linear frequency sweeps in Hz
- Logarithmic frequency sweeps in Hz
- Power sweeps in dBm
- List frequency sweep in Hz. Two independent lists are available.

Interpolated Error Correction. The interpolated error correction feature functions with all sweep types.

Interpolated error correction automatically turns on when the stimulus parameters are changed after measuring calibration data. Refer to Chapter 7 for more information on interpolated error correction.

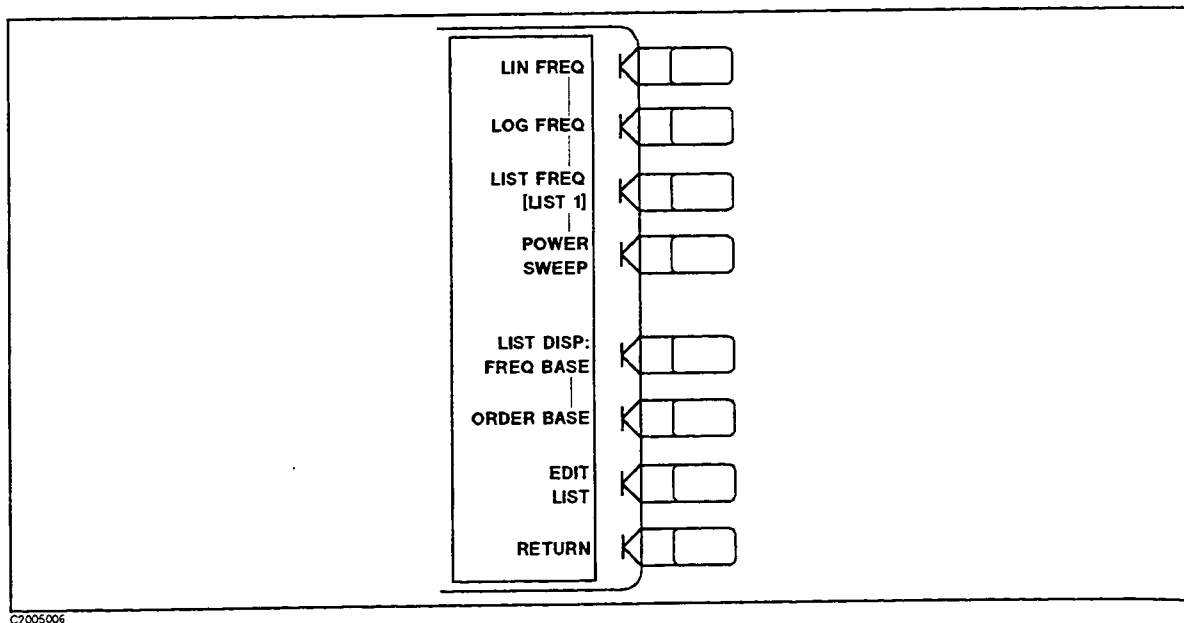

Figure 5-7. Sweep Type Menu

LIN FREQ (LINFREQ) activates a linear frequency sweep mode. The data is displayed on a standard graticule with ten equal horizontal divisions. This is the default preset sweep type.

MENU Key

LOG FREQ (LOGFREQ) activates a logarithmic frequency sweep mode. The source is stepped in logarithmic increments and the data is displayed on a logarithmic graticule.

LIST FREQ [LIST 1] or **LIST FREQ [LIST 2]** (LISFREQ) shows the active list number and activates the frequency list mode, and presents the “List Sweep Menu” if two frequency lists have been defined.

Frequency list mode allows you to measure DUT response over several distinct frequency ranges or at specific frequency points. Each entry in the frequency list is called a *SEGMENT*, regardless of it being a frequency range or single point. Each segment can specify the number of points, source power level, and IF bandwidth. Up to 31 segments can be specified in any combination in one of two independent lists.

Before using frequency list mode, the frequency list must be created. Refer to “Edit List Menu”, “Edit Segment Menu”, and “Edit Segment More Menu” later in this chapter for entering and modifying the lists.

A tabular printout of the frequency list data can be obtained using the **LIST SWEEP TABLE** function in the copy more menu.

POWER SWEEP (POWS) activates a power sweep mode that characterizes power-sensitive DUTs. In this mode, power is swept at a single frequency, from a start power value to a stop power value, selected using the **START** and **STOP** keys and the entry block. This feature is convenient for such measurements as gain compression or AGC (automatic gain control) slope. To set the power sweep frequency, use **CW FREQ** in the stimulus menu. Refer to *the User’s Guide* for an example of a gain compression measurement.

In power sweep, the entered sweep time may be automatically changed if it is less than the minimum required for the current configuration (number of points, IF bandwidth, etc.).

LIST DISP: FREQ BASE (LISDFBASE) displays data measured as frequency base in the frequency list mode. The frequency scale is linear across the total range. Since the frequency points may not distribute evenly across the graticule, the display resolution may be uneven, and more compressed in some parts of the trace than in others.

ORDER BASE (LISDOBASE) displays data measured as order base in the frequency list mode. The displayed frequency resolution is even across the graticule, even though the frequency points are not distributed evenly. (Refer to User’s Guide, for a sample measurement.)

EDIT LIST (EDITLIST) presents the edit list menu. This is used in conjunction with the edit segment menu to define or modify the frequency sweep list. The list frequency sweep mode is selected with the **LIST FREQ [LIST 1]** or **LIST FREQ [LIST 2]** softkey described above.

RETURN goes back to the stimulus menu.

List Sweep Menu

This menu activates one of the frequency lists to be swept. If there is only one list, or no list is defined, the menu will not be provided.

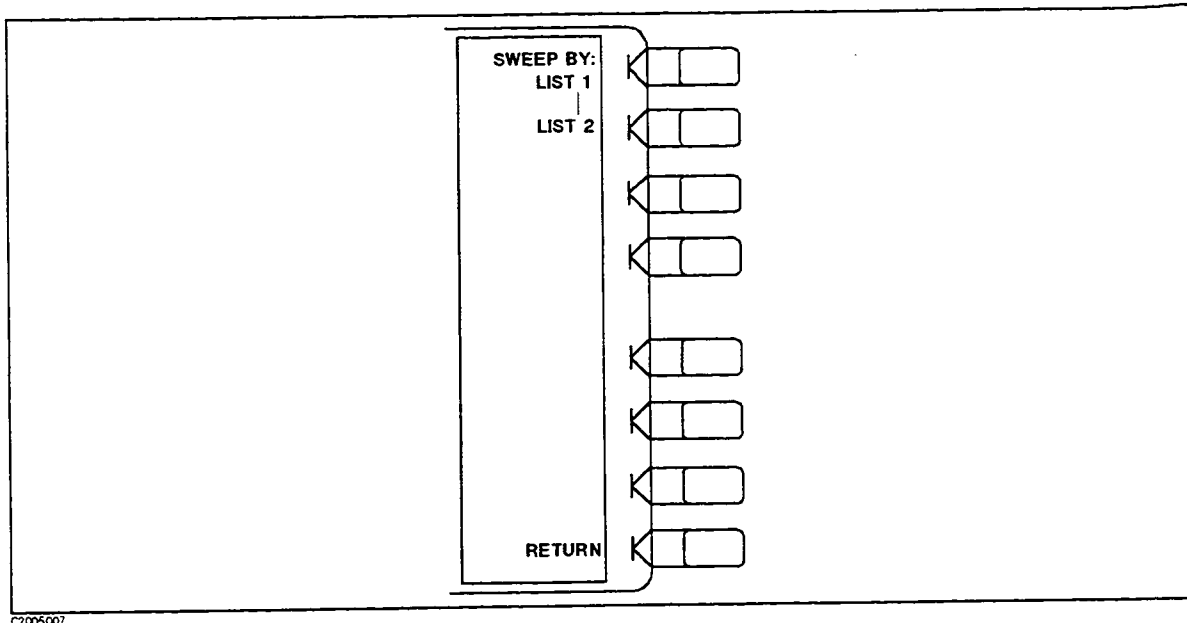

Figure 5-8. List Sweep Menu

SWEEP by:LIST 1 (LISSLIS1) activates LIST 1 for the list sweep.

LIST 2 (LISSLIS2) activates LIST 2 for the list sweep.

RETURN goes back to the sweep type menu without any change.

Edit List Menu

This menu edits the list of frequency segments (subsweep) defined with three other menus. Each of two lists can specify up to 31 frequency segments, for a maximum of 801 points. The segments do not have to be entered in any particular order: the analyzer automatically sorts them and lists them on the display in increasing order of start frequency. This menu determines which segment on the list is to be modified, while other menus change the frequency range, number of points, power level and IF bandwidth of the selected segment.

Note The list and segment data are cleared on instrument preset, cycling the power and instrument state recall. The list and segment data can be saved with the built-in FDD. (Refer to Chapter 11).



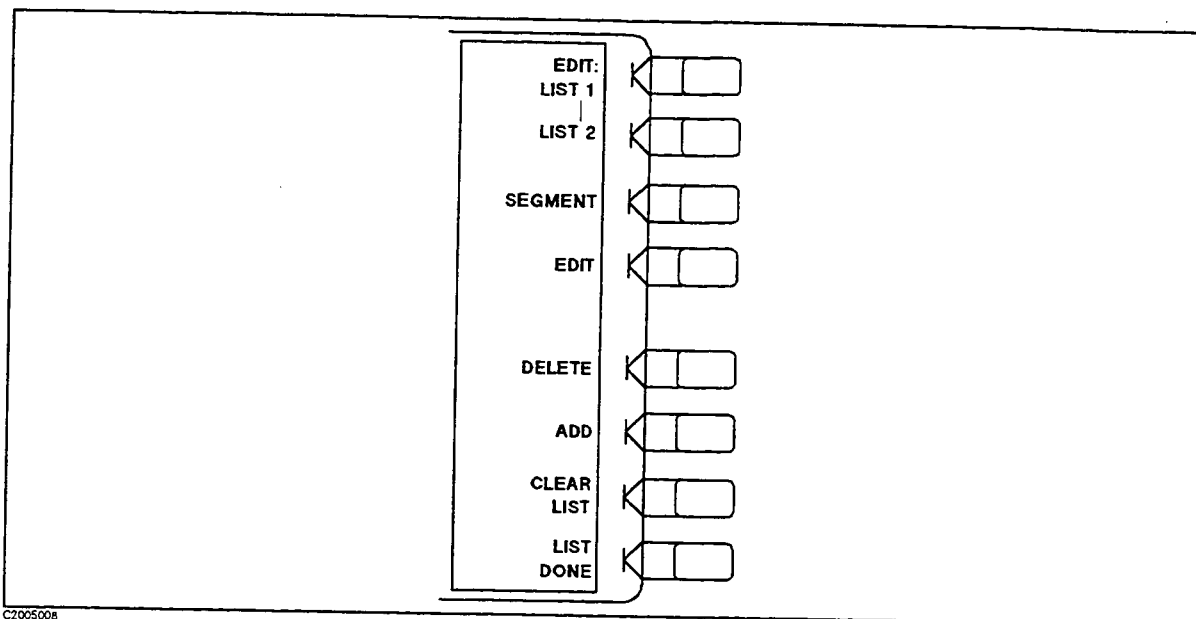

C2005008

Figure 5-9. Edit List Menu

EDIT: LIST 1 (EDITLIS1) selects LIST 1 to edit.

LIST 2 (EDITLIS2) selects LIST 2 to edit.

SEGMENT (SEDI) determines a segment on the list to be modified. Enter the number of a segment in the list, or use the step keys to scroll the pointer ">" at the left to the required segment number. The indicated segment can then be edited or deleted.

EDIT provides the edit segment menu, where the segment indicated by the pointer ">" at the left can be modified.

DELETE (SDEL) deletes the segment indicated by the pointer ">".

ADD (SADD) adds a new segment to be defined with the edit segment menu. If the list is empty, a default segment is added, and the edit segment menu is displayed so it can be modified. If the list is not empty, the segment indicated by the pointer ">" is copied and the edit segment menu is displayed.

CLEAR LIST (CLEL) provides the clear list menu.

LIST DONE (EDITDONE) sorts the frequency points and returns to the sweep type menu.

Edit Segment Menu

This menu is used to select arbitrary measurement frequencies. Using this menu it is possible to define the exact frequencies to be measured on a point-by-point basis. For example the sweep could include 100 points in a narrow passband, 100 points across a broad stop band, and 50 points across the third harmonic response. The total sweep is defined with a list of segments (subsweeps). Up to 31 segments can be defined, with a total of up to 801 data points.

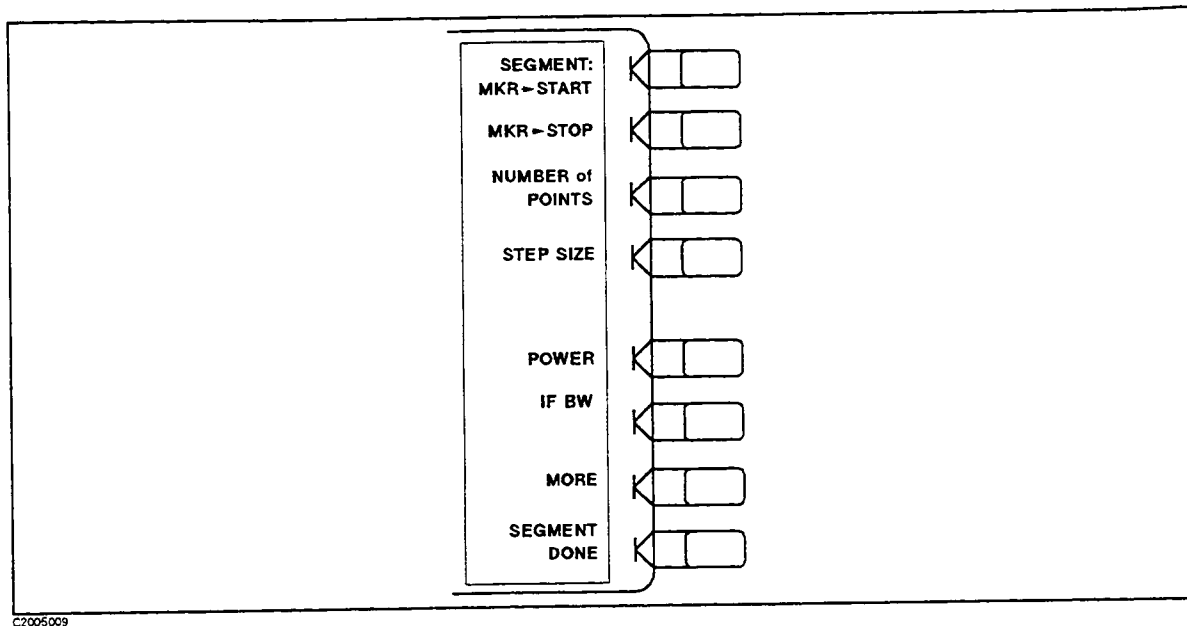

Figure 5-10. Edit Segment Menu

The frequency segments, or segments, can be defined in any of the following terms:

- Start / stop / number of points
- Start / stop / step
- Center / span / number of points
- Center / span / step

The segments can overlap, and do not have to be entered in any particular order. The analyzer sorts the segments automatically and lists them on the display in order of increasing start frequency, regardless of the order in which they are entered. If duplicate frequencies exist, the analyzer makes multiple measurements on identical points to maintain the specified number of points for each segment. The data is displayed as a single trace that is a composite of all data taken when the list display function is frequency base.

The list frequency sweep mode is selected with the **LIST FREQ** softkey in the sweep type menu.

The frequency list parameters can be saved with the built-in floppy disk. (Refer to Chapter 11.)

Note



Not only the softkeys described below, use also the **START**, **STOP**, **CENTER**, and **SPAN** keys to define the stimulus range.

MKR → START (MARKSTAR) sets the stimulus start value to the stimulus value of the active marker.

MKR → STOP (MARKSTOP) sets the stimulus stop value to the stimulus value of the active marker.

NUMBER of POINTS (POINT) sets the number of points for the segment. The total number of points for all the segments cannot exceed 801.

STEP SIZE (STPSIZ) specifies the segment in frequency steps instead of number of points. Changing the start frequency, stop frequency, span, or number of points may change the step size. Changing the step size may change the number of points and stop frequency in start/stop/step mode; or the frequency span in center/span/step mode. In each case, the frequency span becomes a multiple of the step size.

SEGMENT POWER (POWE) sets power level for segment by segment. The allowable range is -50 dBm to +15 dBm and maximum span is 35 dB.

IF BW (IFBW) sets IF bandwidth for segment by segment. The allowable bandwidth are 2, 20, 200, 1 k, and 4 kHz.

MORE goes to the edit segment more menu, which allows key in the stimulus range, **START**, **STOP**, **CENTER**, and **SPAN**.

SEGMENT DONE (SDON) returns to the edit list menu.

Edit Segment More Menu

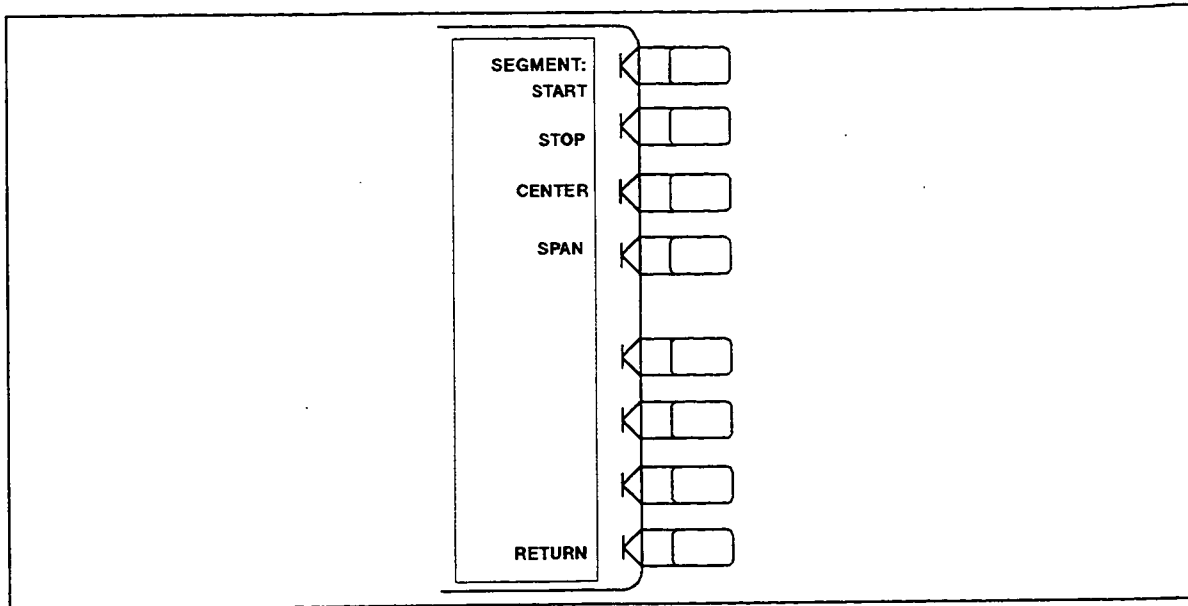

C2005010

Figure 5-11. Edit Segment More Menu

SEGMENT START (STAR) sets the START frequency of a segment.

STOP (STOP) sets the STOP frequency of a segment.

CENTER (CENT) sets the CENTER frequency of a segment.

SPAN (SPAN) sets the frequency SPAN of a segment about a specified center frequency.

RETURN goes back to the edit segment menu.

Clear List Menu

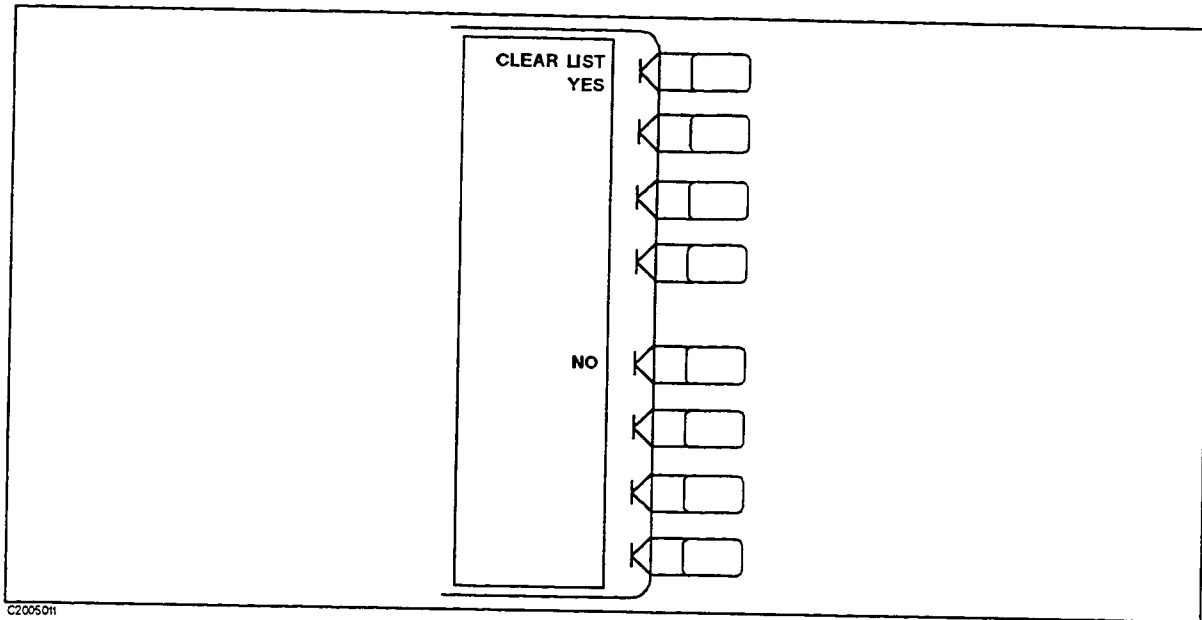

Figure 5-12. Clear List Menu

CLEAR LIST YES (CLEL) clears the entire list.

NO cancels and goes back to the edit list menu.

Response Function Block

INTRODUCTION

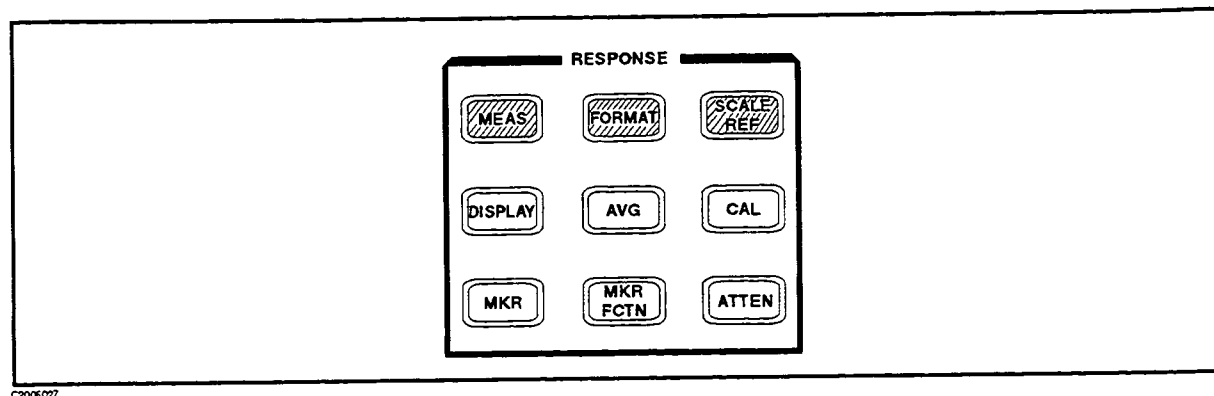

Figure 6-1. Response Function Block

The keys in the *RESPONSE* block control the measurement and display functions of the active channel. They provide access to many different softkey menus that offer selections for the measuring parameters, the display mode and data format, the control of the display markers, a variety of calibration functions, and selections for the internal attenuator.

The HP-IB programming command is shown in parenthesis following the key or softkey.

The current values for the major response functions of the active channel are displayed in specific locations along the top of the display. In addition, certain functions accessed through the keys in this block are annotated in the status notations area at the left side of the display. The locations of these information labels are described in Chapter 2.

The *RESPONSE* block keys and their associated menus are described briefly below, and in more detail in this and the following chapters. General and specific measurement sequences are described in the *User's Guide*.

The **MEAS** key provides access to a series of softkey menus for selecting the parameters or inputs to be measured.

The **FORMAT** key leads to a menu which selects the display format for the data. Various rectangular and polar formats are available for display of magnitude, phase, impedance, group delay, real data, imaginary data, and SWR.

The **SCALE REF** key displays a menu which modifies the vertical axis scale and the reference line value as well as electrical length and phase offset.

The **DISPLAY** key leads to a series of menus for instrument and active channel display functions. This menu includes dual channel display (overlaid or split), definition of the displayed active channel trace in terms of the mathematical relationship between data and

MEAS Key

trace memory, conjugate matching function, display intensity, color selection, active channel display title, and frequency blanking.

The **AVG** key accesses three different noise reduction techniques: sweep-to-sweep averaging, trace smoothing, group delay aperture, and variable IF bandwidth.

The **ATTEN** key provides the attenuation menu from which the attenuators at the input A, B, and R are set.

The **CAL** key, **MKR** and **MKR FCTN** keys are explained later. For information on **CAL**, refer to Chapter 7. For information on **MKR**, and **MKR FCTN**, refer to Chapter 8.

MEAS KEY

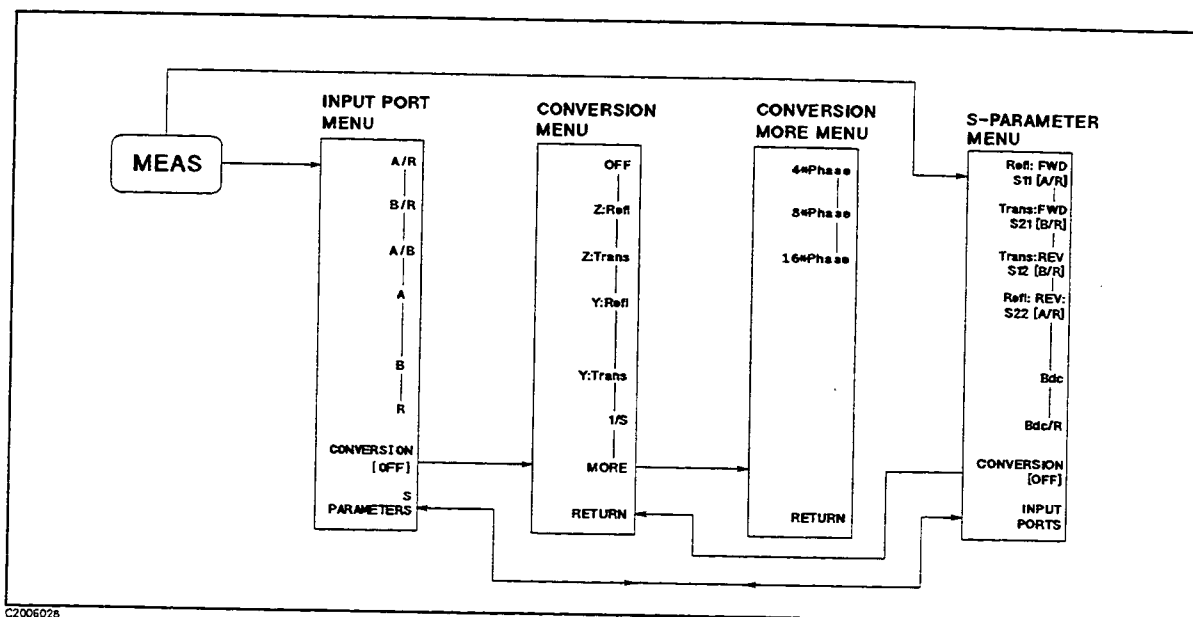

Figure 6-2. Softkey Menus Accessed from the **MEAS** Key

The HP-IB programming command is shown in parenthesis following the key or softkey.

The **MEAS** key leads to a series of softkey menus from which the parameters and measurement inputs are specified. If an S-parameter test set is connected to the HP 8751A, all four S-parameters can be measured with a single DUT connection setup. S-parameters can also be measured using a transmission/reflection test set by reversing the DUT test connections between measurements. A brief explanation of S-parameters follows:

Alternatively, the power ratio of any two inputs or the absolute power at any input can be measured and the results displayed, using either test set.

Using the HP 8751A's internal math capabilities, S-parameters can be converted to impedance (Z), admittance (Y), or inverse S-parameters.

The math capabilities allow multiplying phase data by a factor of 4, 8, or 16.

S-Parameters

S-parameters (scattering parameters) are a convention which characterizes the way a device modifies signal flow. A brief explanation is provided here of the S-parameters of a two-port device. For additional details refer to Hewlett-Packard Application Notes *A/N 95-1* and *A/N 154*.

S-parameters are always a ratio of two complex (magnitude and phase) quantities. S-parameter notation identifies these quantities using the numbering convention:

$$S_{\text{out in}}$$

where the first number (**out**) refers to the port where the signal is emerging and the second number (**in**) is the port where the signal is incident. For example, the S-parameter S_{21} identifies the measurement as the complex ratio of the signal emerging at port 2 to the signal incident at port 1.

Figure 6-3 is a representation of the S-parameters of a two-port device, together with an equivalent flowgraph. In the illustration, "a" represents the signal entering the device and "b" represents the signal emerging. Note that a and b are not related to the A and B input ports on the analyzer.

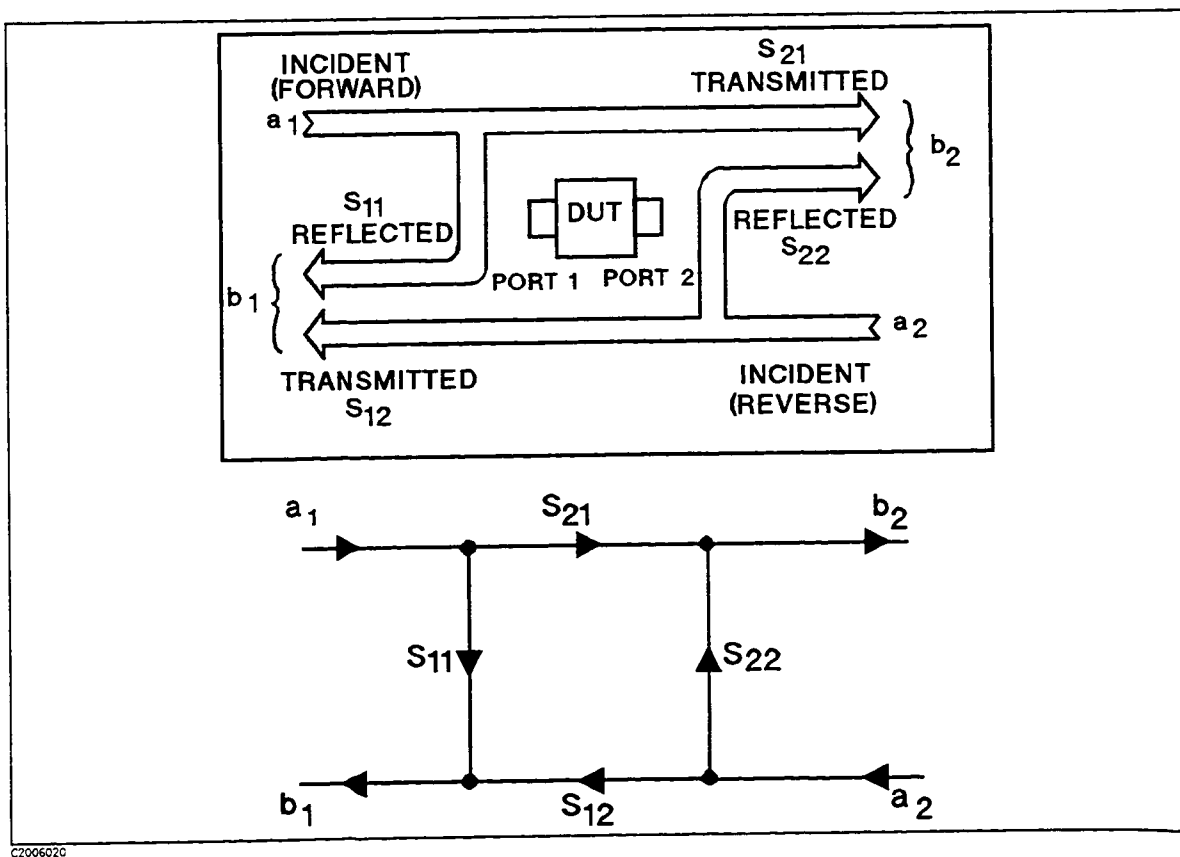

Figure 6-3. S-Parameters of a Two-Port Device

S-parameters are exactly equivalent to the more common description terms below, requiring only that the measurements are taken with all DUT ports properly terminated.

MEAS Key

S-Parameter	Definition	Test Set Description	Direction
S ₁₁	$\frac{b_1}{a_1} _{a_2=0}$	Input reflection Coefficient	FWD
S ₂₁	$\frac{b_2}{a_1} _{a_2=0}$	Forward gain	FWD
S ₁₂	$\frac{b_1}{a_2} _{a_1=0}$	Reverse gain	REV
S ₂₂	$\frac{b_2}{a_2} _{a_1=0}$	Output reflection coefficient	REV

DC Voltage Measurement

The analyzer is capable of DC voltage measurement, which is useful for testing DUTs whose output is a DC voltage in response to an RF signal input, for example detectors, peak-detector circuits, F-V (frequency to voltage) converters.

In addition, mixer transmission characteristics can be measured. In general, network analyzers cannot measure those characteristics, because a mixer is a device whose input and output signal frequencies differ. Using this DC voltage measurement capability, with a detector or demodulator which converts the mixer output signal to a DC voltage, makes measurement of these characteristics possible.

S-Parameter Menu

The S-parameter menu is presented automatically when the **MEAS** key is pressed, if a test set is connected to the analyzer or if two-port error correction is ON. This menu defines the input ports and test set direction for S-parameter measurements. The analyzer controls the S-parameter test set, and automatically switches the direction of the measurement according to the selections made in this menu. All four S-parameters can be measured with a single connection. The S-parameter being measured is labeled at the top left corner of the display.

S-parameter measurements can also be made using HP 87512A,B transmission/reflection test kits, by reversing the device under test after making the forward reflection and transmission measurements. In this case, the softkey labels are changed to indicate the actual input ratios being measured (A/R for reflection or B/R for transmission measurements). Thus **Ref1: REV S22 (B/R)** becomes **Ref1: REV S22 (A/R)**, and **Trans: REV S12 (A/R)** becomes **Trans: REV S12 (B/R)**. However, the annotation in the top left corner indicates the S-parameter being measured.

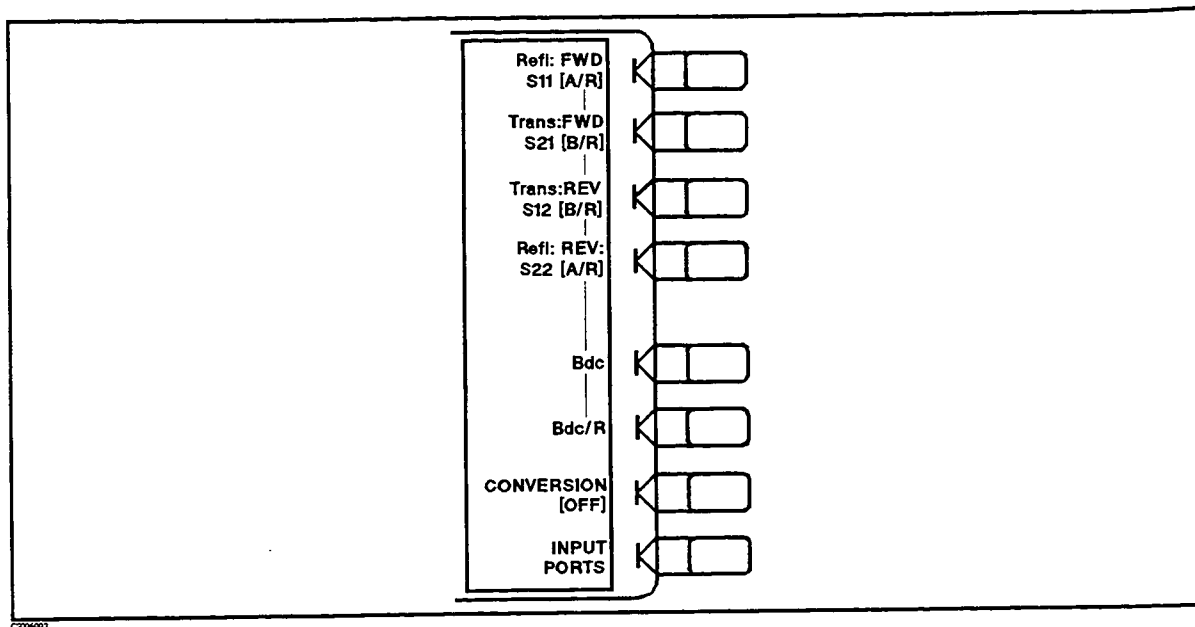

Figure 6-4. S-Parameter Menu

Refl: FWD S11 (A/R) (S11) configures the S-parameter test set for measurement of S_{11} , the complex reflection coefficient (magnitude and phase) of the test device input.

Trans: FWD S21 (B/R) (S21) configures the S-parameter test set for measurement of S_{21} , the complex forward transmission coefficient (magnitude and phase) of the device under test.

Trans: REV S12 (A/R) (S12) configures the S-parameter test set for measurement of S_{12} , the complex reverse transmission coefficient (magnitude and phase) of the device under test.

Refl: REV S22 (B/R) (S22) defines the measurement as S_{22} , the complex reflection coefficient (magnitude and phase) of the output of the device under test.

Note



If the HP 87512A,B transmission/reflection test kits are being used to make S-parameter measurements, the device under test must be reversed before S_{12} and S_{22} are measured.

Bdc (BDC) displays a DC voltage at input B, on the vertical axis.

Bdc/R (BDCR) calculates and displays the ratio of a DC voltage at input B to the reference signal at input R.

CONVERSION (CONV) brings up the conversion menu which converts the measured data to impedance (Z) or admittance (Y). When a conversion parameter has been defined, it is shown in brackets under the softkey label. If no conversion has been defined, the softkey label reads **CONVERSION [OFF]**.

INPUT PORTS goes to the input ports menu, which is used to define a ratio or single-input measurement rather than an S-parameter measurement.

MEAS Key

Input Ports Menu

The input ports menu is presented when the **MEAS** key is pressed if there is no S-parameter test set connected and two-port error correction is not on. This menu defines the input ports for power ratio measurements, or a single input for magnitude only measurements of absolute power.

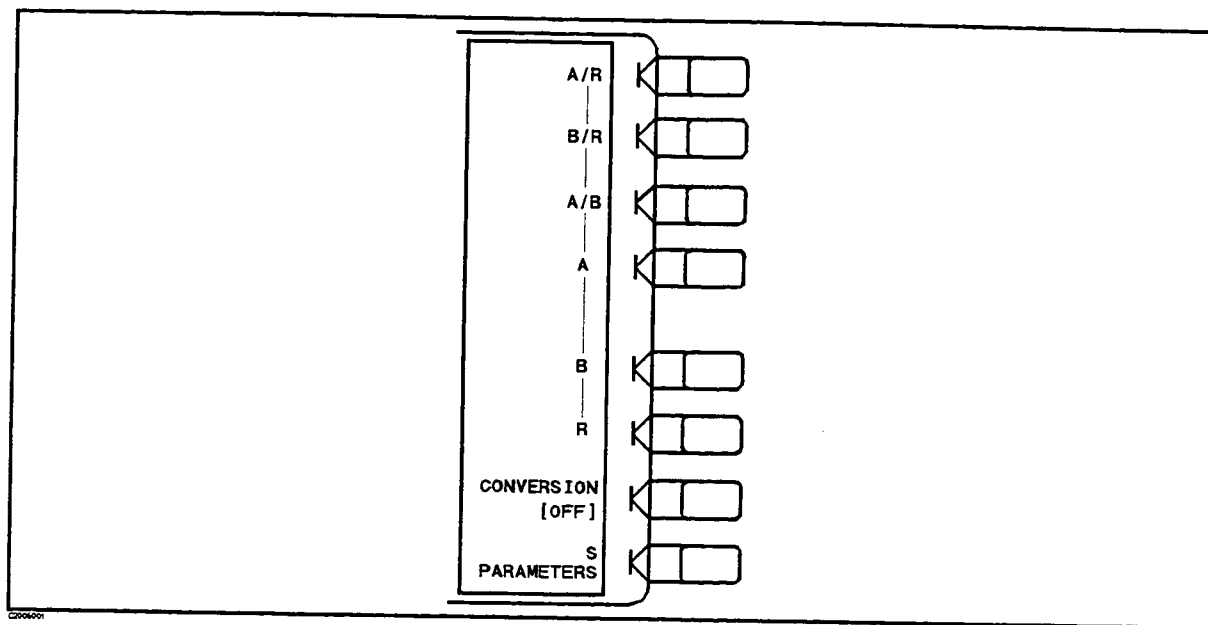

Figure 6-5. Input Ports Menu

A/R (AR) calculates and displays the complex ratio of the signal at input A to the reference signal at input R.

B/R (BR) calculates and displays the complex ratio of input B to input R.

A/B (AB) calculates and displays the complex ratio of input A to input B.

A (MEASA) measures the absolute power amplitude at input A.

B (MEASB) measures the absolute power amplitude at input B.

R (MEASR) measures the absolute power amplitude at input R.

CONVERSION presents the conversion menu, which converts the measured data to impedance (Z) or admittance (Y). When a conversion parameter has been defined, it is shown in brackets under the softkey label. If no conversion has been defined, the softkey label reads **CONVERSION OFF**. **S PARAMETERS** presents the S-parameter menu, which defines the input ports and test set direction for S-parameter measurements.

Conversion Menu

This menu converts the measured reflection or transmission data to the equivalent complex impedance (Z) or admittance (Y) values. This is not the same as a two-port Y or Z parameter conversion, as only the measured parameter is used in the equations. Two simple one-port conversions are available, depending on the measurement configuration.

An S_{11} or S_{22} trace measured as reflection can be converted to an equivalent parallel impedance or admittance using the model and equations shown in Figure 6-6.

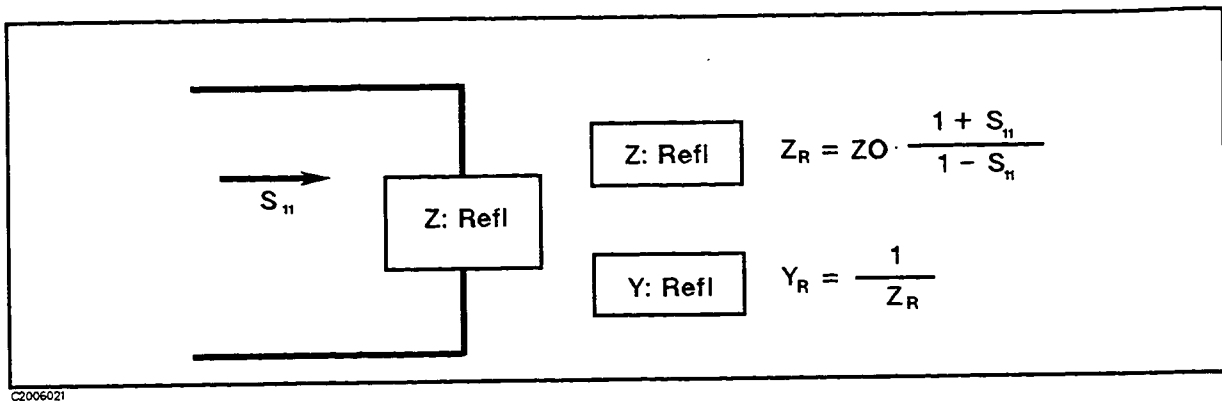

C2006021

Figure 6-6. Reflection Impedance and Admittance Conversions

In a transmission measurement, the data can be converted to its equivalent series impedance or admittance using the model and equations shown in Figure 6-7.

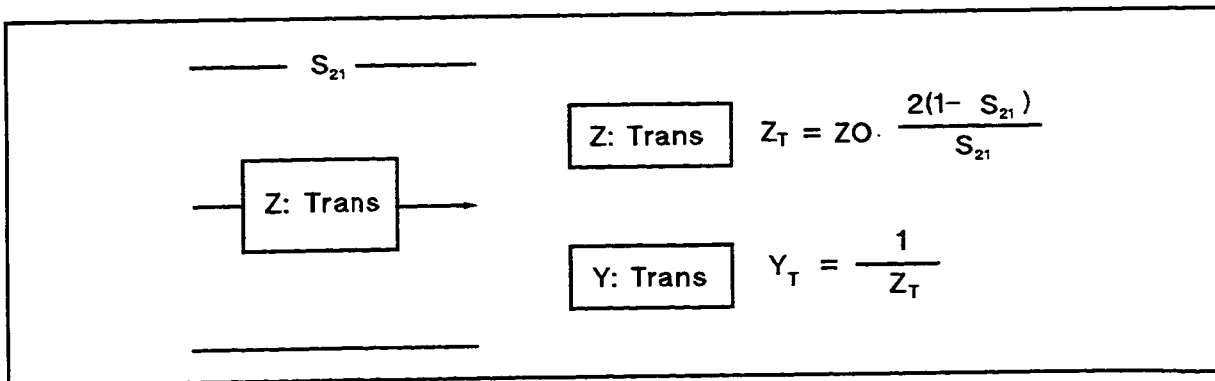

C2006022

Figure 6-7. Transmission Impedance and Admittance Conversions

Avoid using Smith chart, SWR, and delay formats for displaying Z and Y conversions, as these formats are not easily interpreted.

In all conversions except for "1/S", marker values are impedance values in Ω units for Z conversions, or admittance values in S units for Y conversions in any format.

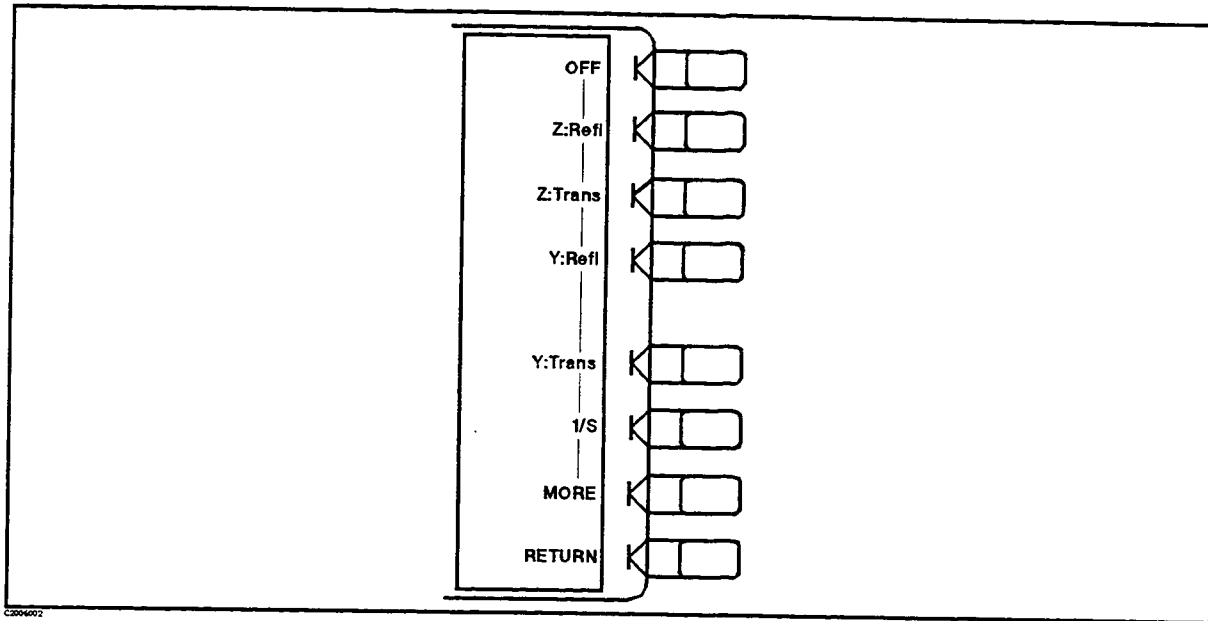

Figure 6-8. Conversion Menu

OFF (CONVOFF) turns off all parameter conversion operations.

Z: Refl (CONVZREF) converts reflection data to its equivalent impedance values.

Z: Trans (CONVZTRA) converts transmission data to its equivalent impedance values.

Y: Refl (CONVYREF) converts reflection data to its equivalent admittance values.

Y: Trans (CONVYTRA) converts transmission data to its equivalent admittance values.

1/S (CONV1DS) expresses the data in inverse S-parameter values, for use in amplifier and oscillator design.

MORE provides the Conversion More menu described in the next section.

RETURN returns to the last menu, either the S-parameter or the input ports menu.

Conversion More Menu

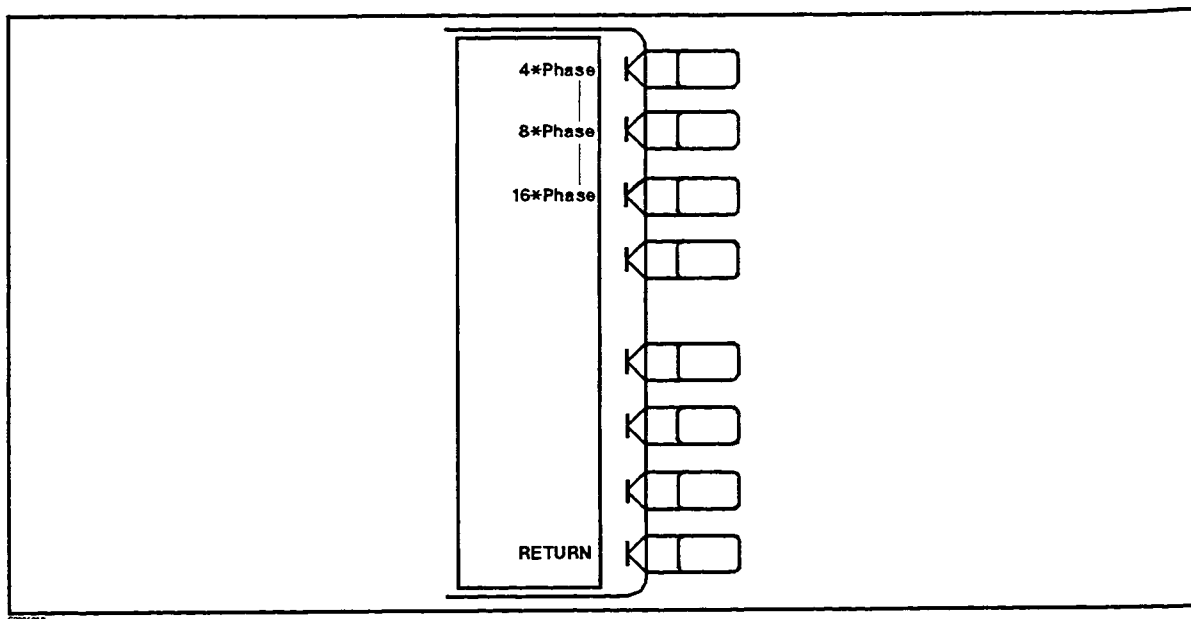

Figure 6-9. Conversion More Menu

4*phase (CONVMP4) multiplies phase data by a factor of 4.

8*phase (CONVMP8) multiplies phase data by a factor of 8.

16*phase (CONVMP16) multiplies phase data by a factor of 16.

RETURN returns to the conversion menu.

FORMAT Key

FORMAT KEY

The HP-IB programming command is shown in parenthesis following the key or softkey.

Format Menu

The **FORMAT** key presents a menu used to select the appropriate display format for the measured data. Various rectangular and polar formats are available for display of magnitude, phase, real data, imaginary data, impedance, group delay, and SWR. The units of measurement are changed automatically to correspond with the displayed format. Special marker menus are available for the polar and Smith formats, each providing several different marker types for readout of values (Refer to Chapter 8).

The illustrations below show a reflection measurement of a band pass filter displayed in each of the available formats. Measurement procedure is described in *the User's Guide*.

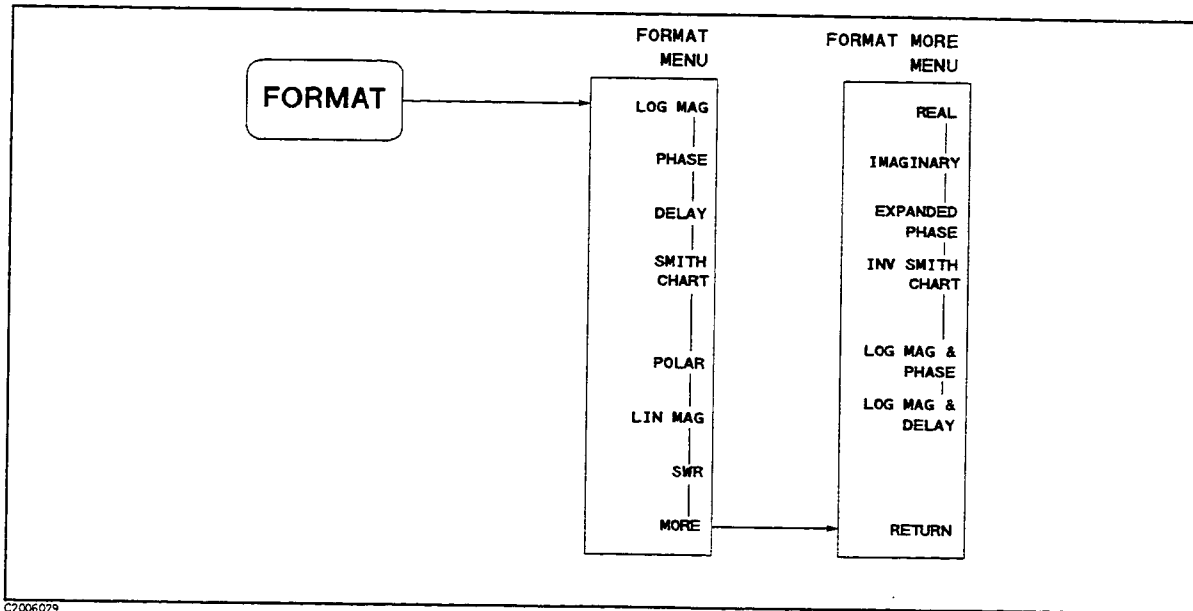

Figure 6-10. Format and Format More Menus

LOG MAG (LOGM) displays the log magnitude format. This is the standard Cartesian format used to display magnitude-only measurements of insertion loss, return loss, or absolute power in dB versus frequency. Figure 6-11 illustrates the bandpass filter reflection data in a log magnitude format.

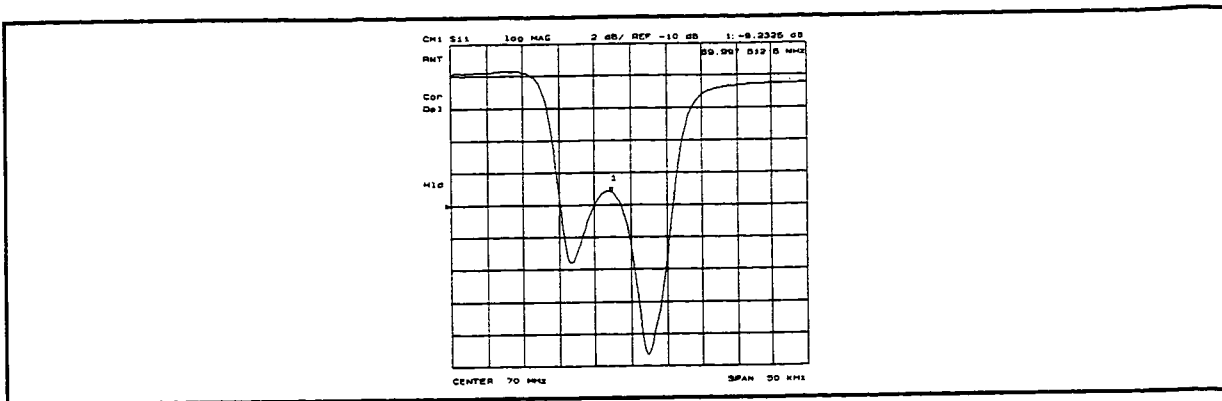

Figure 6-11. Log Magnitude Format

PHASE (PHAS) displays a Cartesian format of the phase portion of the data, measured in degrees. This format displays the phase shift versus frequency. Figure 6-12 illustrates the phase response of the same filter in a phase-only format.

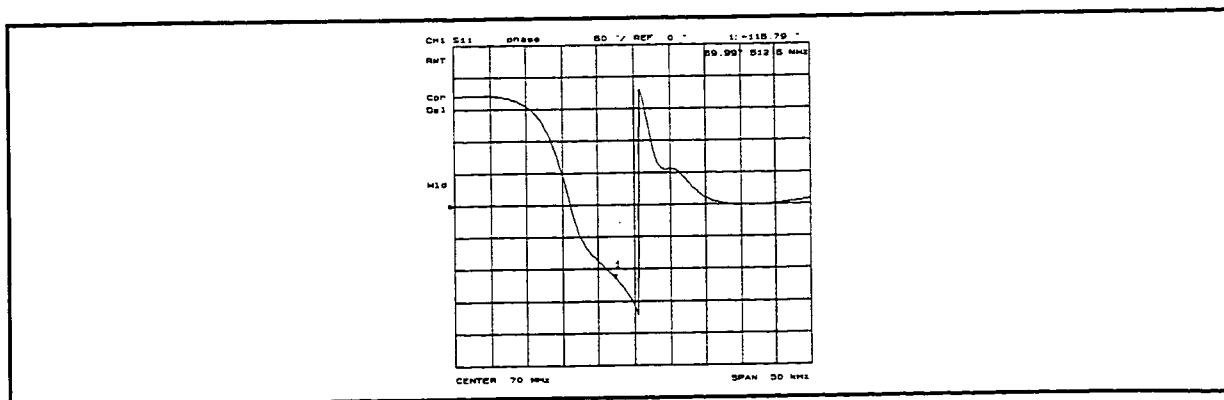

Figure 6-12. Phase Format

FORMAT Key

DELAY (DELA) selects the group delay format. Activated markers give values in seconds. Figure 6-13 shows the bandpass filter response formatted as group delay. When power sweep is selected, this selects the delay format using delta power instead of frequency. Group delay principles are described in the next few pages.

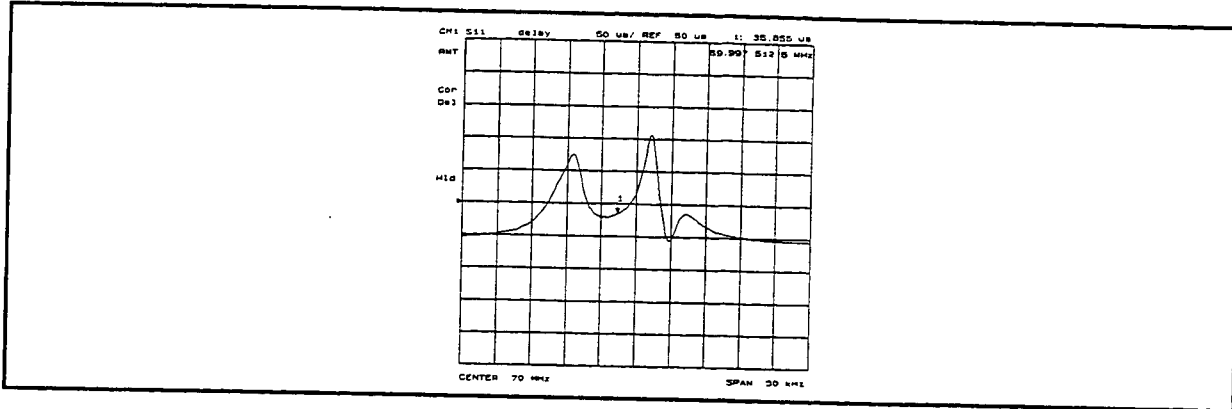

Figure 6-13. Group Delay Format

SMITH CHART (SMIC) displays a Smith chart format (Figure 6-14). This is used in reflection measurements to provide a readout of the data in terms of impedance. The intersecting lines on the Smith chart represent constant resistance and constant reactance values, normalized to the characteristic impedance, Z_0 , of the system. Reactance values in the upper half of the Smith chart circle are positive (inductive) reactance, and in the lower half of the circle are negative (capacitive) reactance. The default marker readout is in units of resistance and reactance ($R+jX$). Additional marker types are available in the Smith marker menu (refer to Chapter 8).

The Smith chart is most easily understood with a full scale value of 1.0. If the scale per division is less than 0.2, the format switches automatically to polar.

If the characteristic impedance of the system is not 50 Ω , modify the impedance value recognized by the analyzer using the **SET Z0** softkey in the calibrate more menu. (Refer to Chapter 7.)

Procedures for measuring impedance are provided in *the User's Guide*.

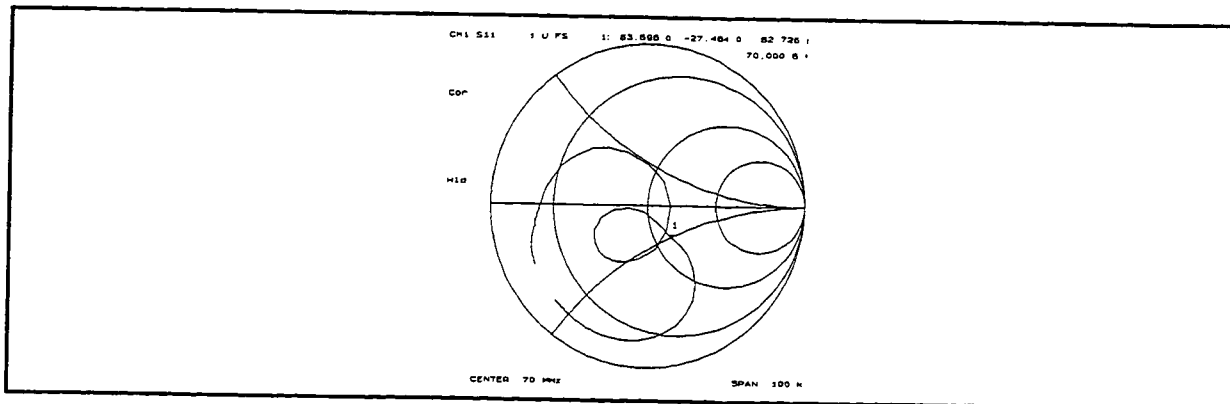

Figure 6-14. Smith Chart Format

POLAR (POLA) displays a polar format (Figure 6-15). Each point on the polar format corresponds to a particular value of both magnitude and phase. Quantities are read vectorally: the magnitude at any point is determined by its displacement from the center (which has zero value), and the phase by the angle counterclockwise from the positive x-axis. Magnitude is scaled in a linear fashion, with the value of the outer circle usually set to a ratio value of 1. Since there is no frequency axis, frequency information is read from the markers.

The default marker readout for the polar format is in linear magnitude and phase. A log magnitude marker and a real/imaginary marker are available in the polar marker menu (refer to Chapter 8).

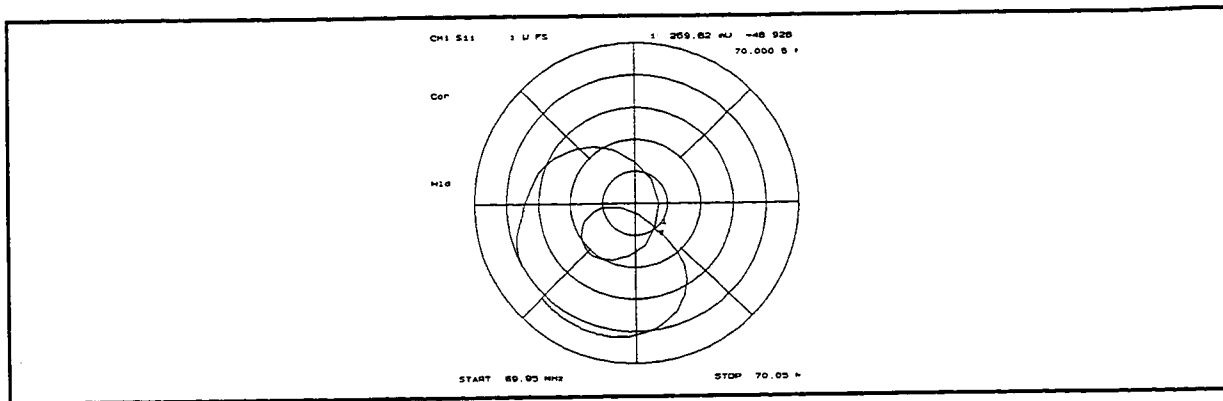

Figure 6-15. Polar Format

LIN MAG (LINM) displays the linear magnitude format (Figure 6-16). This is a Cartesian format used for unitless measurements such as reflection coefficient magnitude ρ or transmission coefficient magnitude τ , and for linear measurement units. It is used for display of conversion parameters.

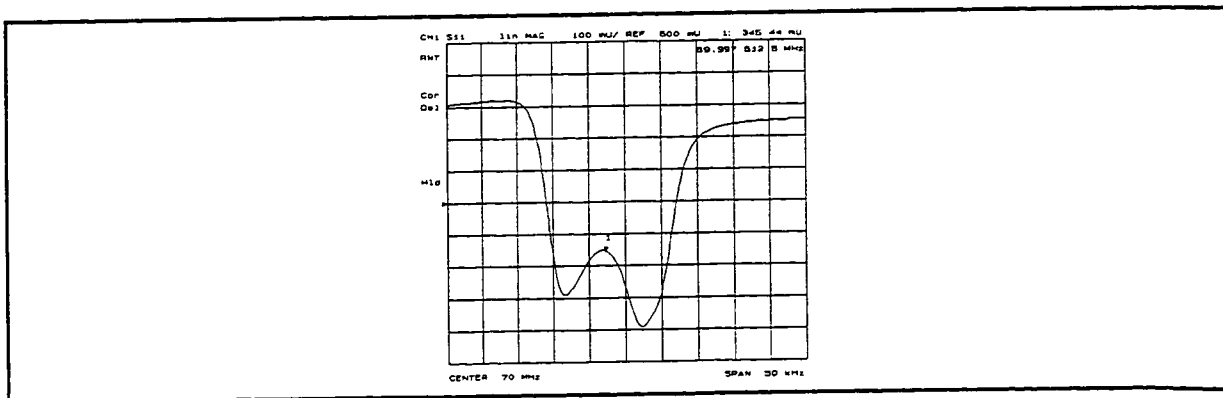

Figure 6-16. Linear Magnitude Format

FORMAT Key

SWR (SWR) reformats a reflection measurement into its equivalent SWR (standing wave ratio) value (Figure 6-17). SWR is equivalent to $(1+|\rho|)/(1-|\rho|)$, where ρ is the reflection coefficient.

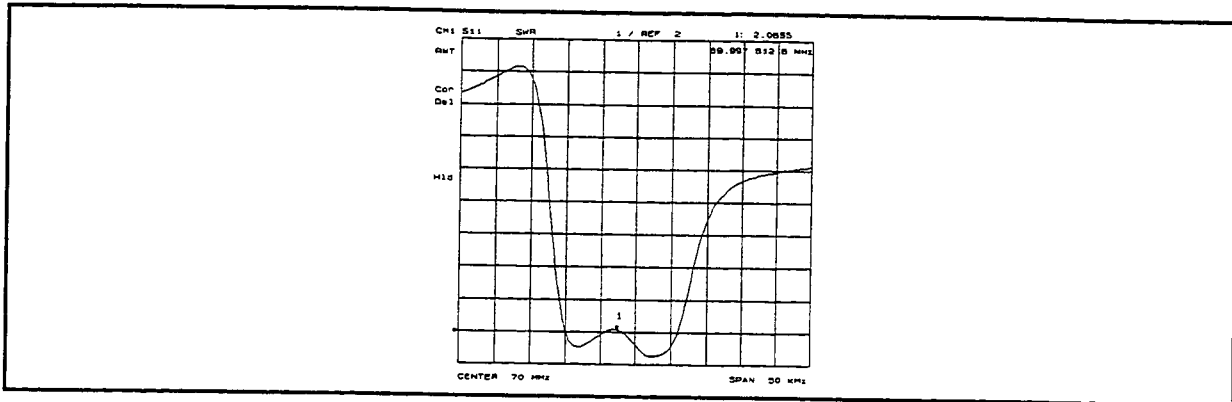

Figure 6-17. Typical SWR Display

MORE provides the format more menu described in the next section.

Format More Menu

This menu provides two additional formatting selections.

REAL (REAL) displays only the real (resistive) portion of the measured data on a Cartesian format (Figure 6-18). This is similar to the linear magnitude format, but can show both positive and negative values. It is primarily used to display a Bdc input voltage signal.

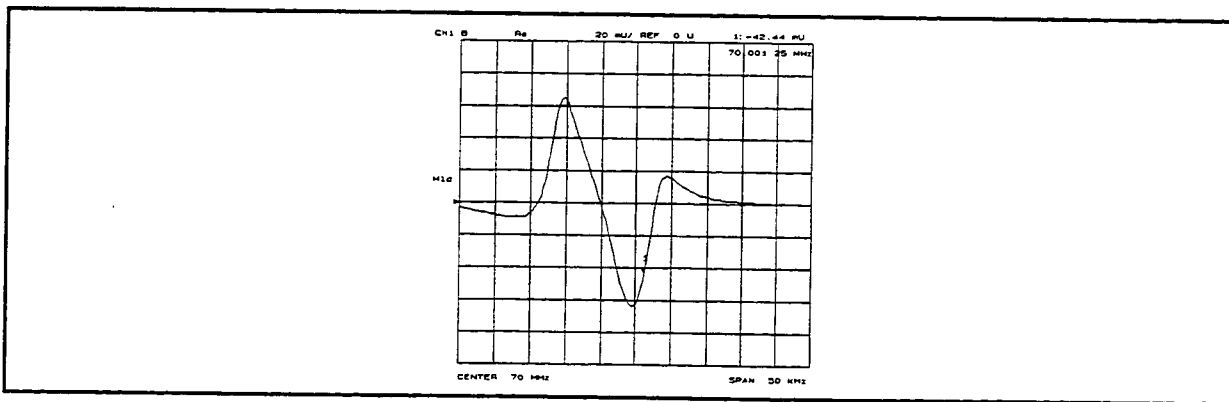

Figure 6-18. Real Format

IMAGINARY (IMAG) displays only the imaginary (reactive) portion of the measured data on a Cartesian format. This format is similar to the real format except that reactance data is displayed on the trace instead of impedance data.

EXPANDED PHASE (EXPP) displays the phase plot over 360°(Figure 6-19). When this is turned on, the analyzer avoids the phase plot wrap around every 360°.

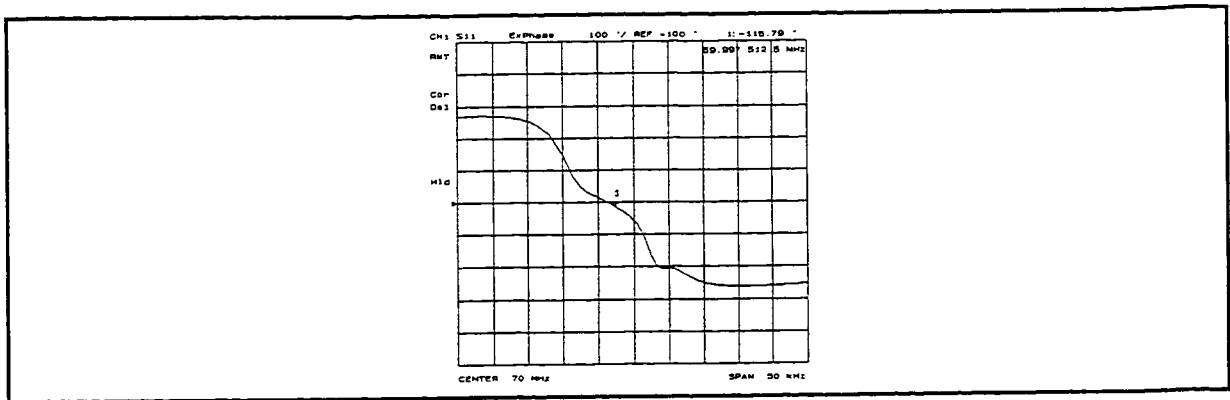

Figure 6-19. Expanded phase Format

INV SMITH CHART (INVSCHAR) displays a inverse Smith chart (admittance Smith chart) format (Figure 6-20). This format is used in reflection measurement to provide a readout of the data in terms of admittance.

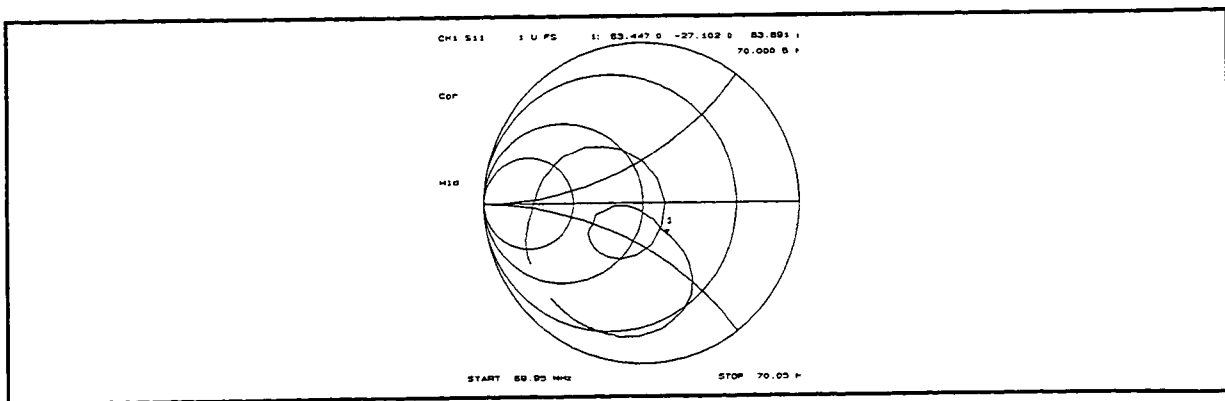

Figure 6-20. Inverse Smith Chart Formats

FORMAT Key

LOG MAG & PHASE (LOGMP) displays log magnitude trace and phase trace for the active channel simultaneously. When this softkey is turned on, some other softkeys will denote the log magnitude trace and the phase as "DATA" and "MEMORY", respectively.

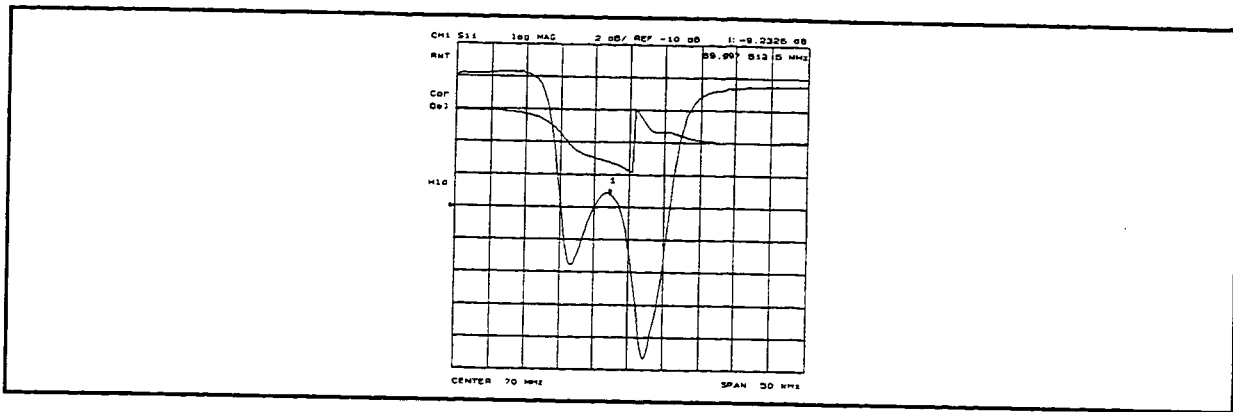

Figure 6-21. Log Magnitude and Phase Format

LOG MAG & DELAY (LOGMD) displays log magnitude trace and delay trace for the active channel simultaneously. When this softkey is turned on, some other softkeys will denote the log magnitude trace and the delay as "DATA" and "MEMORY", respectively.

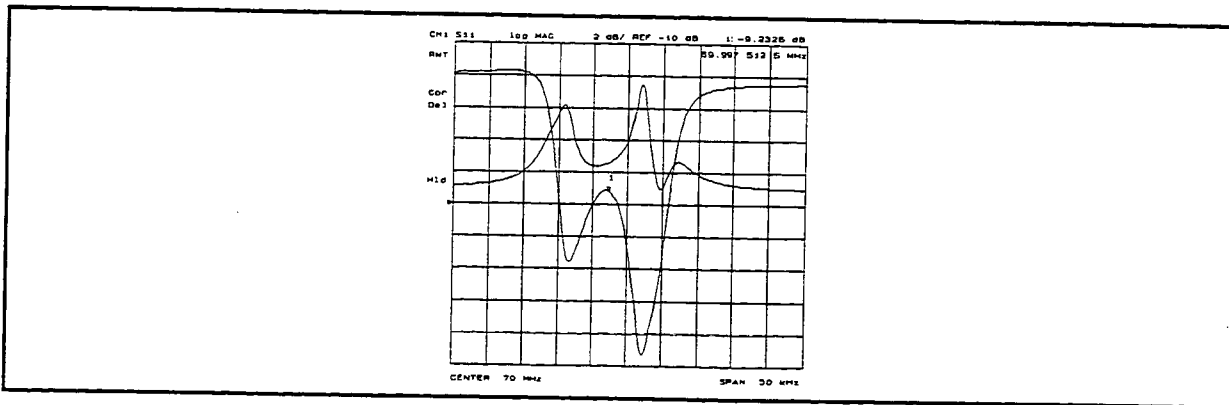

Figure 6-22. Log magnitude and Delay Format

RETURN goes back to the format menu.

GROUP DELAY PRINCIPLES

For many networks, the amount of insertion phase is not as important as the linearity of the phase shift over a range of frequencies.

The analyzer can measure this linearity and express it in two different ways: directly, as deviation from linear phase, or as group delay, a derived value. Refer to **SCALE REF** key description in this chapter for information on deviation from linear phase.

Group delay is the measurement of signal transmission time through a test device. It is defined as the derivative of the phase characteristic with respect to frequency. Since the derivative is basically the instantaneous slope (or rate of change of phase with frequency), a perfectly linear phase shift results in a constant slope, and therefore a constant group delay (Figure 6-23).

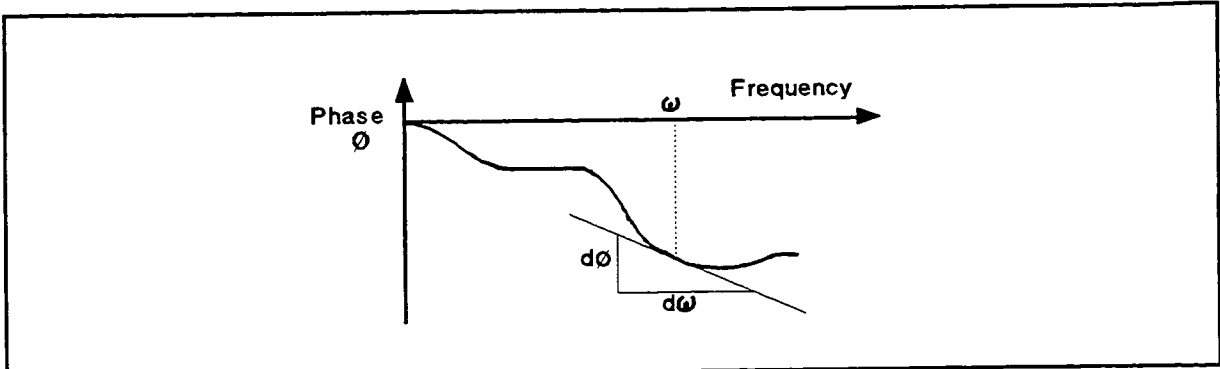

C2006023

Figure 6-23. Constant Group Delay

Note, however, that the phase characteristic typically consists of both linear (first order) and higher order (deviations from linear) components. The linear component can be attributed to the electrical length of the test device, and represents the average signal transit time. The higher order components are interpreted as variations in transit time for different frequencies, and represent a source of signal distortion (Figure 6-24).

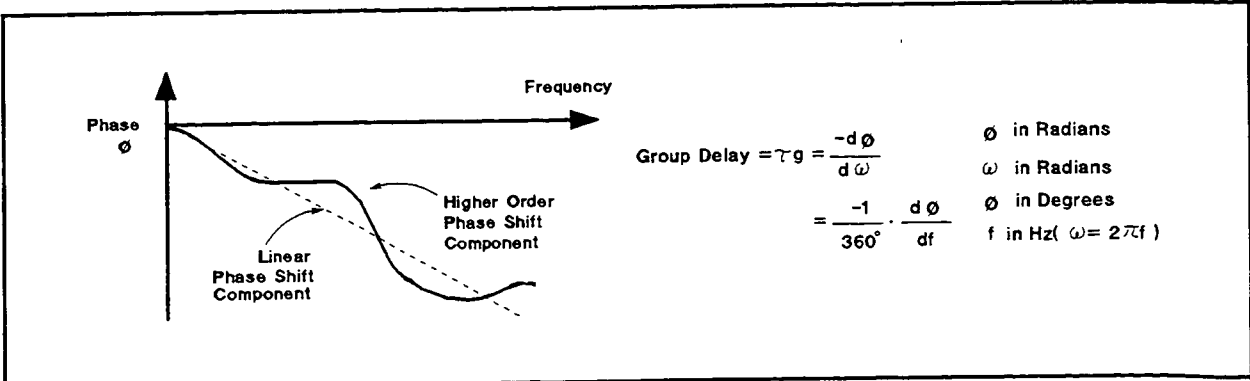

C2006024

Figure 6-24. Higher Order Phase Shift

Group Delay Principles

The analyzer computes group delay from the phase slope. Phase data is used to find the phase deviation, $\Delta\phi$, at the center point of a specified frequency aperture, Δf , to obtain an approximation for the rate of change of phase with frequency (Figure 6-25). This value, τ_g , represents the group delay in seconds assuming linear phase change over Δf .

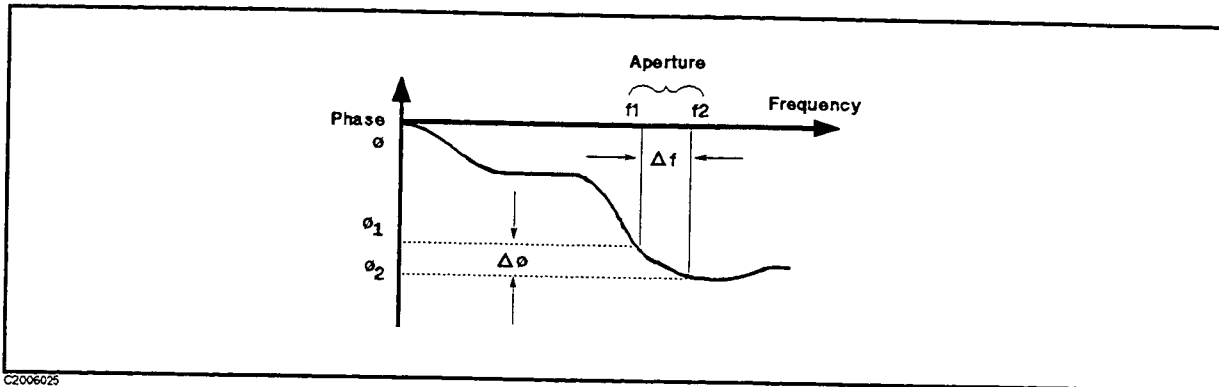

Figure 6-25. Rate of Phase Change Versus Frequency

When deviations from linear phase are present, changing the frequency step can result in different values for group delay. Note that in this case the computed slope varies as the aperture Δf is increased (Figure 6-26). A wider aperture results in loss of the fine grain variations in group delay. This loss of detail is the reason that in any comparison of group delay data it is important to know the aperture used to make the measurement.

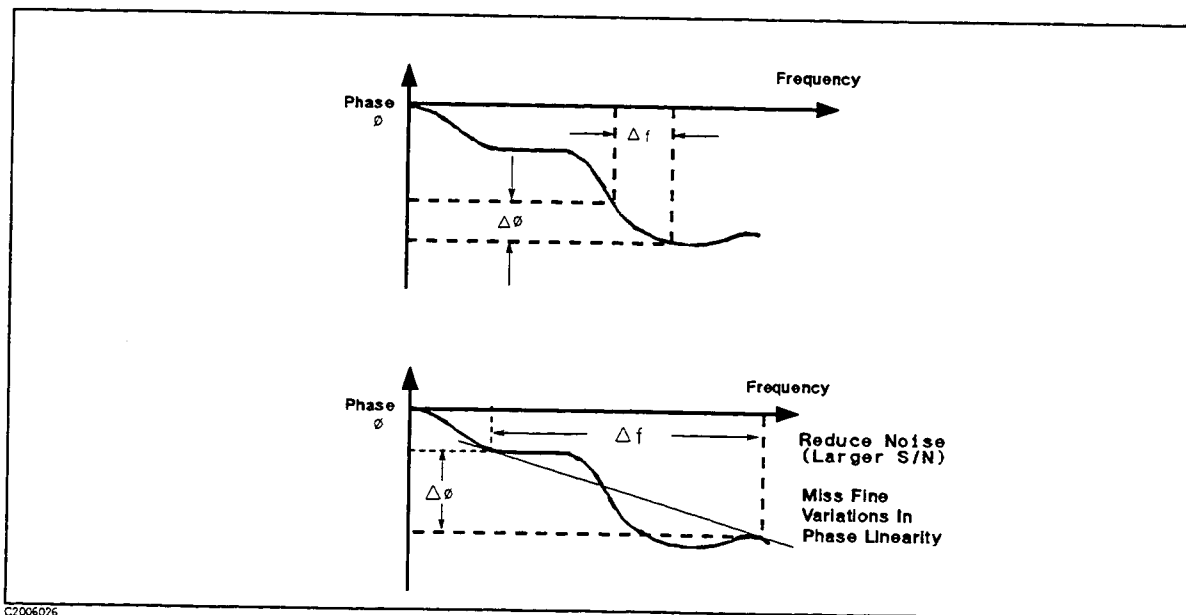

Figure 6-26. Variations in Frequency Aperture

In determining the group delay aperture, there is a tradeoff between resolution of fine detail and the effects of noise. Noise can be reduced by increasing the aperture, but this will tend to smooth out the fine detail. More detail will become visible as the aperture is decreased, but the noise will also increase, possibly to the point of obscuring the detail. A good practice

Group Delay Principles

is to use a smaller aperture to assure that small variations are not missed, then increase the aperture to smooth the trace.

The group delay aperture value will be a percent of the stimulus span swept which is based on the number of points. For example, the default value of 1% means that a group delay at a certain point is calculated using adjacent measurement points on both sides, if the number of points is 201.

Group delay measurements can be made on linear frequency, log frequency, or list frequency sweep types (avoid the use of the power sweep, it will be meaningless). Group delay aperture varies depending on the frequency spacing and point density, therefore the aperture is not constant in log and list frequency sweep modes.

To obtain a readout of aperture values at different points on the trace, move the marker to a desired point. Then press **AVG** **GROUP DELY APERTURE**. Group delay aperture becomes the active function, and as the aperture is varied its value in Hz is displayed below the active entry area.

A group delay measurement procedure is provided in *the User's Guide*.

SCALE REF Key

SCALE REF KEY

The HP-IB programming command is shown in parenthesis following the key or softkey.

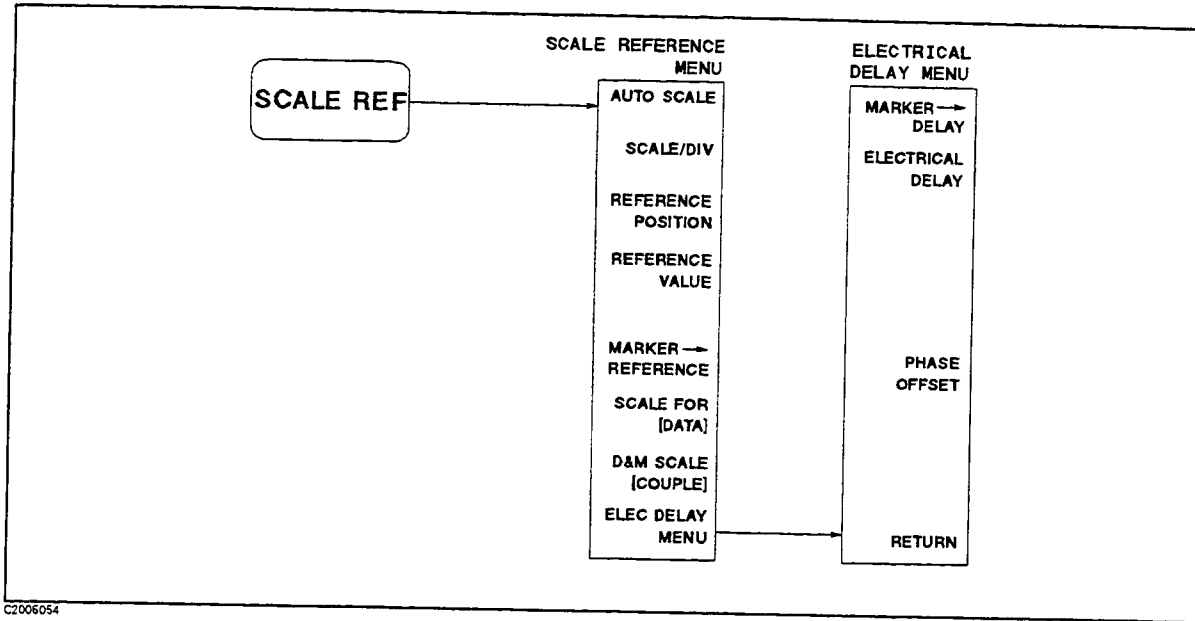

Figure 6-27. Softkey Menus Accessed from the **SCALE REF** Key

Scale Reference Menu

The **SCALE REF** key makes scale per division the active function. A menu is displayed that modifies the vertical axis scale and the reference line value and position. In addition this menu provides phase offset capabilities for adding or subtracting a phase offset, that is constant with frequency, and electrical delay capability for adding or subtracting linear phase to maintain phase linearity.

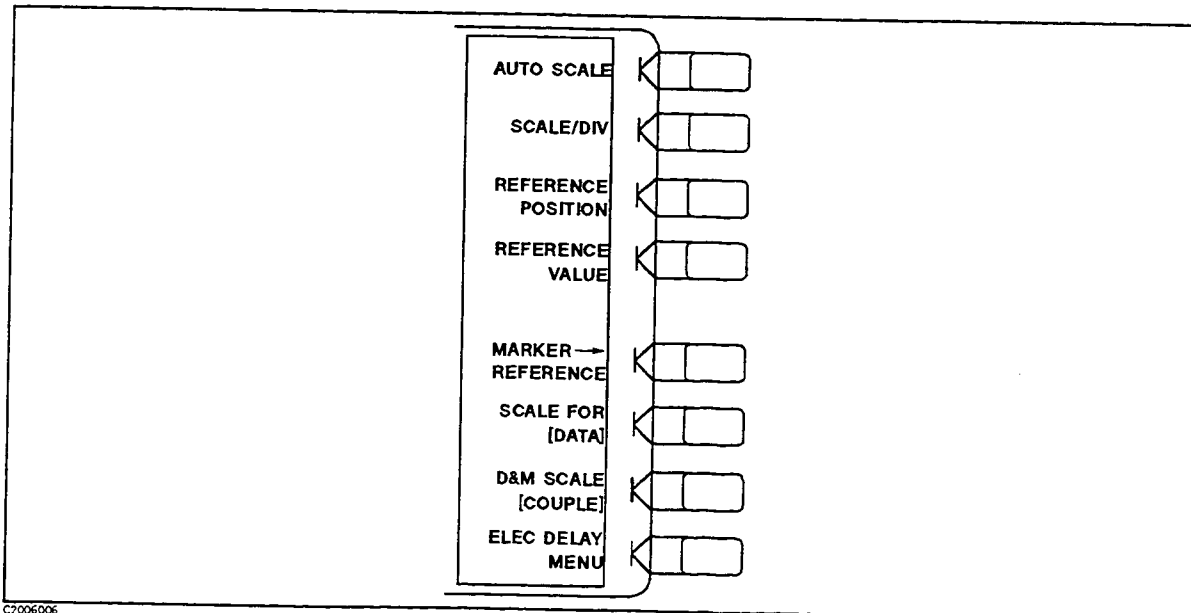

Figure 6-28. Scale Reference Menu

AUTO SCALE (AUTO) brings the trace data, defined by the **SCALE FOR** key, in view on the display with one keystroke. Stimulus values are not affected, only scale and reference values. The analyzer determines the smallest possible scale factor that will put all displayed data onto the vertical graticule. The reference value is chosen to put the trace in center screen, then rounded to an integer multiple with 1-2-5 step of the scale factor.

SCALE/DIV (SCAL) changes the response value scale per division of the displayed trace. In polar and Smith chart formats, this refers to the full scale value at the outer circumference, and is identical to the reference value.

REFERENCE POSITION (REFP) sets the position of the reference line on the graticule of a Cartesian display, with 0 at the bottom line of the graticule and 10 at the top line. It has no effect on a polar or Smith display. The reference position is indicated with a small triangle just outside the graticule, on the left.

REFERENCE VALUE (REFV) changes the value of the reference line, moving the measurement trace correspondingly. In polar and Smith chart formats, the reference value is the same as the scale, and is the value of the outer circle.

MARKER → REFERENCE (MARKREF) makes the reference value equal to the active marker's absolute value (regardless of the delta marker value). The marker is effectively moved to the reference line position. This softkey also appears in the marker function menu accessed from the **MKR FCTN** key. In polar and Smith chart formats this function makes the full scale value at the outer circle equal to the active marker response value.

SCALE FOR (SCAFDATA for data, SCAFMEMO for memory) selects one of "DATA" and "MEMORY" traces to be scaled by prior functions in this menu, when the format is selected anyone except "LOG MAG & PHASE" and "LOG MAG & DELAY". When "LOG MAG & PHASE" or "LOG MAG & DELAY" format is selected, **SCALE FOR** selects one of "LOG MAG" and "PHASE"(for LOGMAG and PHASE) or "DELAY"(for LOGMAG and DELAY) to be scaled.

The "DATA" AND "MEMORY" traces will be available using the "Trace Math Menu" accessed from the **DISPLAY** key. The "LOG MAG & PHASE" and "LOG MAG & DELAY" format will be available using the "FORMAT MORE MENU" accessed from the **FORMAT** key.

D&M SCALE (SCAC for coupling, SCAU for uncoupling) couples or uncouples the "DATA" and "MEMORY" traces to be scaled by prior functions in this menu. This is valid only for those traces obtained by the "Trace Math Menu" accessed from the **DISPLAY** key. The "LOG MAG & PHASE" or "LOG MAG & DELAY" traces are not valid.

ELEC DELAY MENU provides "Electrical Delay Menu", which adds or subtracts a linear phase slope relative to frequency or a constant phase.

Electrical Delay Menu

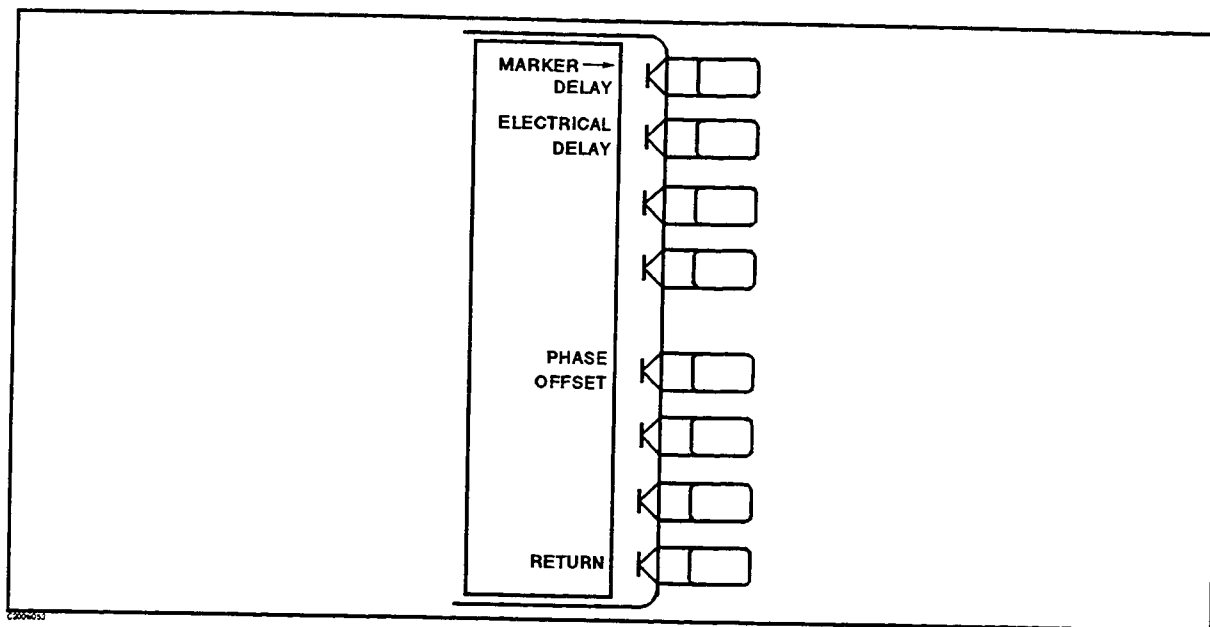

Figure 6-29. Electrical Delay Menu

MARKER → DELAY (MARKDELA) enters the group delay at the active marker point of a fixed frequency aperture, 20 % of the span, to the electrical delay to balance the phase of the DUT. This effectively flattens the phase trace around the active marker, and can measure electrical length or deviation from linear phase. Additional electrical delay adjustment is required for DUTs without constant group delay over the measured frequency span. Since this feature adds phase to a variation in phase versus frequency, it is applicable only for ratioed input.

ELECTRICAL DELAY (ELED) adjusts the electrical delay to balance the phase shift of the DUT. It simulates a variable length lossless transmission line, which can be added to or removed from a receiver input to compensate for interconnecting cables, etc. This function is similar to the mechanical or analog “line stretchers” of other network analyzers. Delay is annotated in units of time with secondary labeling in distance for the current velocity factor.

With this feature, and with **MARKER → DELAY**, an equivalent length of air is added or subtracted according to the following formula:

$$\text{Length (meters)} = \frac{\phi}{\text{Frequency (MHz)} \times 1.20083}$$

Once the linear portion of the DUT's phase has been removed, the equivalent length of air can be read out in the active entry area. If the average relative permittivity (ϵ_r) of the DUT is known over the frequency span, the length calculation can be adjusted to indicated the actual length of the DUT more closely. This can be done by entering the relative velocity factor for the DUT using the calibrate more menu. The relative velocity factor for a given dielectric can be calculated by:

$$\text{Velocity factor} = \frac{1}{\sqrt{\epsilon_r}}$$

assuming a relative permeability of 1.

A procedure for measuring electrical length or deviation from linear phase using the **MARKER → DELAY** or **ELECTRICAL DELAY** features is provided in the *User's Guide*.

PHASE OFFSET (PHAO) adds or subtracts a phase offset that is constant with frequency (rather than linear). The allowable range is -360° to $+360^\circ$. This is independent of **MARKER → DELAY** and **ELECTRICAL DELAY**.

RETURN goes back to the scale reference menu.

DISPLAY Key

DISPLAY KEY

The HP-IB programming command is shown in parenthesis following the key or softkey.

The **DISPLAY** key provides access to the trace math functions, and other display functions including dual channel display, active channel display title, frequency blanking, display intensity, background intensity, color selection, and conjugate matching function.

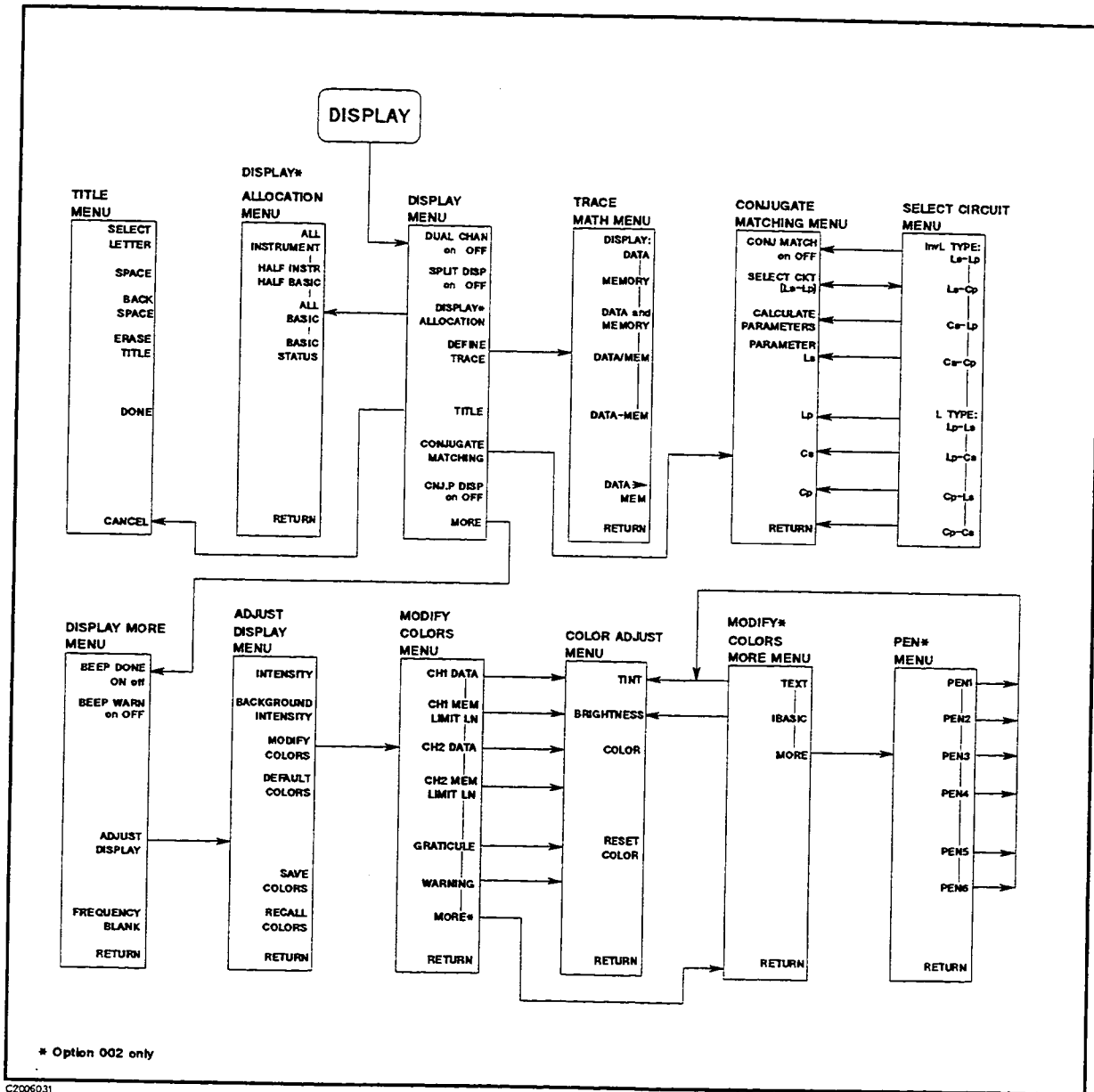

Figure 6-30. Softkey Menus Accessed from the **DISPLAY** Key

Display Menu

This menu provides the capability of displaying both channels simultaneously, either overlaid or split.

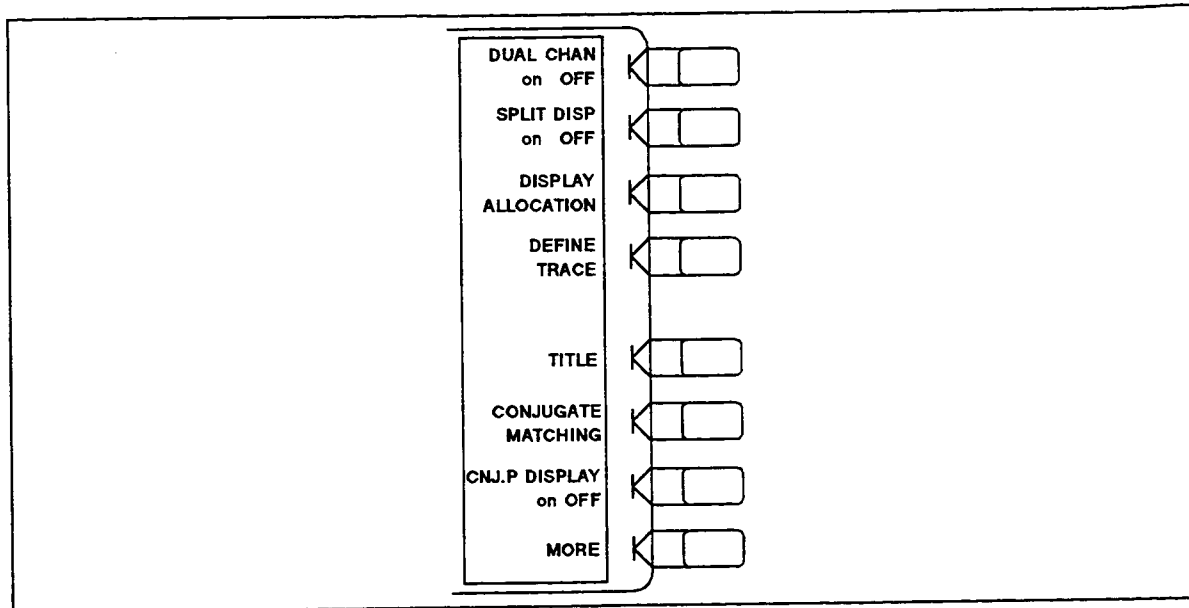

Figure 6-31. Display Menu

DUAL CHAN on OFF (DUACON, DUACOFF) toggles between display of both measurement channels or the active channel only. This is used in conjunction with **SPLIT DISP ON off** to display both channels.

Problems with Dual Channel Mode

If you are using dual channel, there are two measurement configurations which may not appear to function “properly”.

The three configurations, shown below, would cause repeated switching the output power switch and the test port transfer switch. To avoid premature wearing out of these mechanical devices, the test set will not allow these measurements to occur without direct intervention by the operator:

Channel 1 is driving one test port and channel 2 is driving the other. For example, you are making an S_{21} measurement on channel 1 and an S_{12} measurement on channel 2. This configuration, if allowed unchecked, would cause the test port transfer switch to continually cycle.

Channel 1 requires one output power level, and channel 2 requires a different value.

If the HP 85046A,B S-parameter test set is used, in a test set with internal attenuator, channel 1 requires one attenuation value, and channel 2 requires a different value. Since one attenuator is used for both test ports, this would cause the attenuator to continuously switch settings.

DISPLAY Key

If one of the above conditions exist, the test set hold mode will engage, and the status notation "msH" will appear on the left side of the screen. The hold mode may be over-ridden by either the **MEASURE RESTART** or **NUMBER of GROUPS** softkeys under the **MENU** key, as described in Chapter 5. For more information, refer to "MECHANICAL SWITCH HOLD" in Chapter 5.

SPLIT DISP on OFF (SPLDON, SPLDOFF) toggles between a full-screen single graticule display of one or both channels, and a split display with two half-screen graticules one above the other. Both displays are illustrated in Figure 6-32. The split display can be used in conjunction with **DUAL CHAN ON** to show the measured data of each channel simultaneously on separate graticules. In addition, the stimulus functions of the two channels can be controlled independently using **COUPLED CH OFF** in the stimulus menu. The markers can also be controlled independently for each channel using **MARKERS: UNCOUPLED** in the marker mode menu.

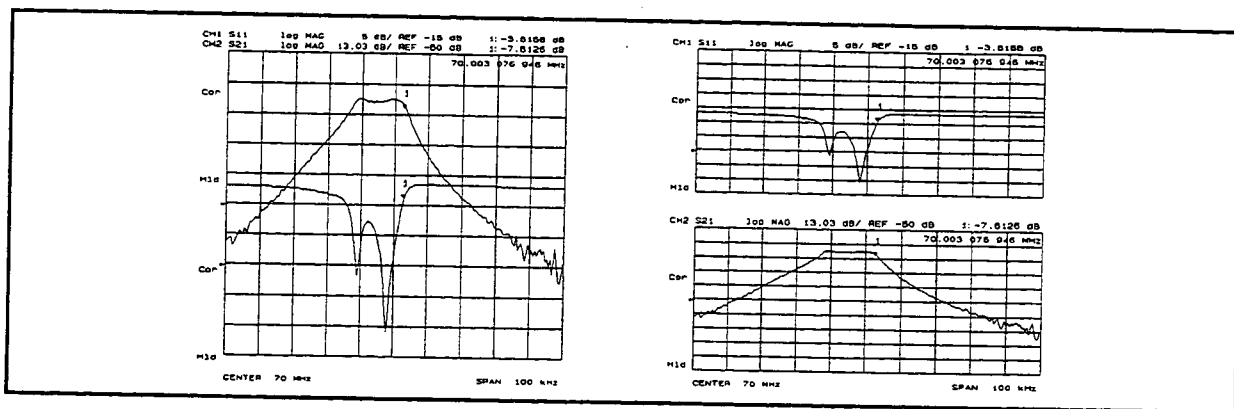

Figure 6-32. Full-screen and Split Display

DISPLAY ALLOCATION appears only when the analyzer is equipped with Instrument BASIC (Option 002). This brings up the allocation menu which selects a full-screen display of measured data or the Instrument BASIC display, and a split display with two half-screens, one graticule display above the Instrument BASIC display.

DEFINE TRACE leads to the trace math menu, which defines a trace from measurement data and memory data.

TITLE (TITL) presents the title menu in the softkey labels area and the character set in the active entry area. These label the active channel display.

CONJUGATE MATCHING presents the conjugate matching menu, which select a proper matching circuit and calculate the device parameters, to match the system characteristic impedance. Simulation is also provided using the matching circuit.

CNJ P DISP on OFF (CONPDISPON, CONPDISPOFF) toggles the indicator of the conjugate matching circuit parameters ON or OFF on the display. This is useful when making a hard copy of the conjugate matched DUT's trace.

MORE leads to the display more menu.

Display More Menu

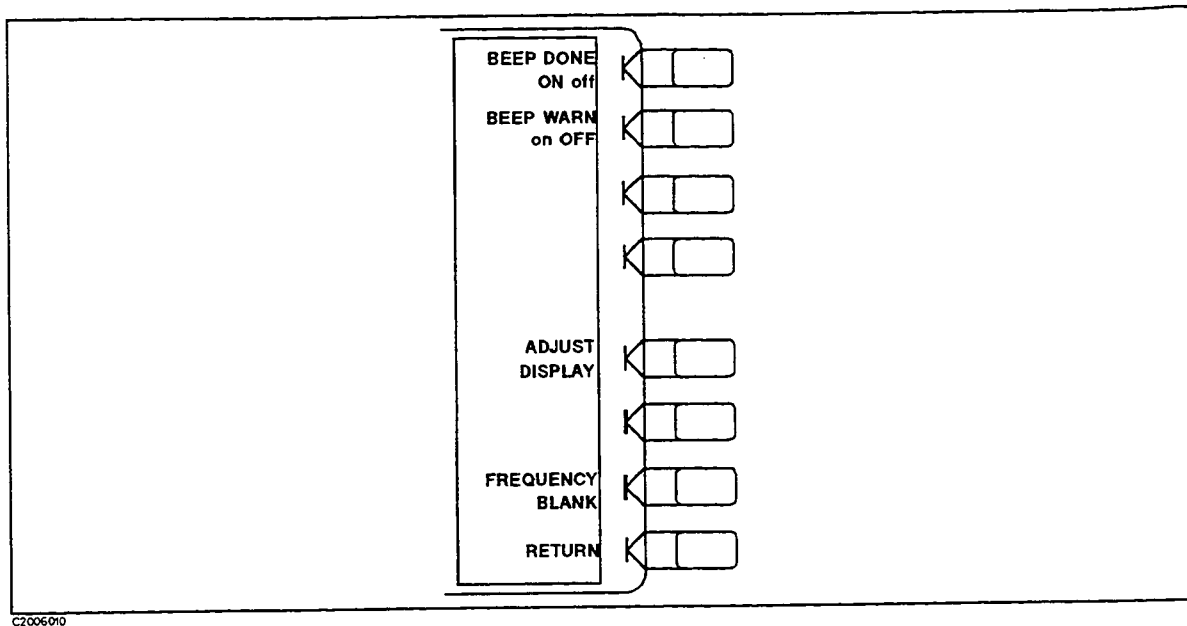

Figure 6-33. Display More Menu

BEEP DONE ON off (BEEPDONEON, BEEPDONEOFF) toggles an annunciator which sounds to indicate completion of certain operations such as calibration or instrument state save.

BEEP WARN on OFF (BEEPWARNON, BEEPWARNOFF) toggles the warning annunciator. When the annunciator is ON it sounds a warning when a cautionary message is displayed.

ADJUST DISPLAY provides a menu for adjusting display intensity, colors, and accessing save and recall functions for modified display color sets.

FREQUENCY BLANK (FREO) blanks the displayed frequency notation for security purposes. Frequency labels cannot be restored except by instrument preset or turning the power off and then on.

RETURN goes back to the display menu.

Display Allocation Menu

Note

This menu will be available for the analyzer equipped with Instrument BASIC (Opt. 002). Otherwise, this will not be provided.



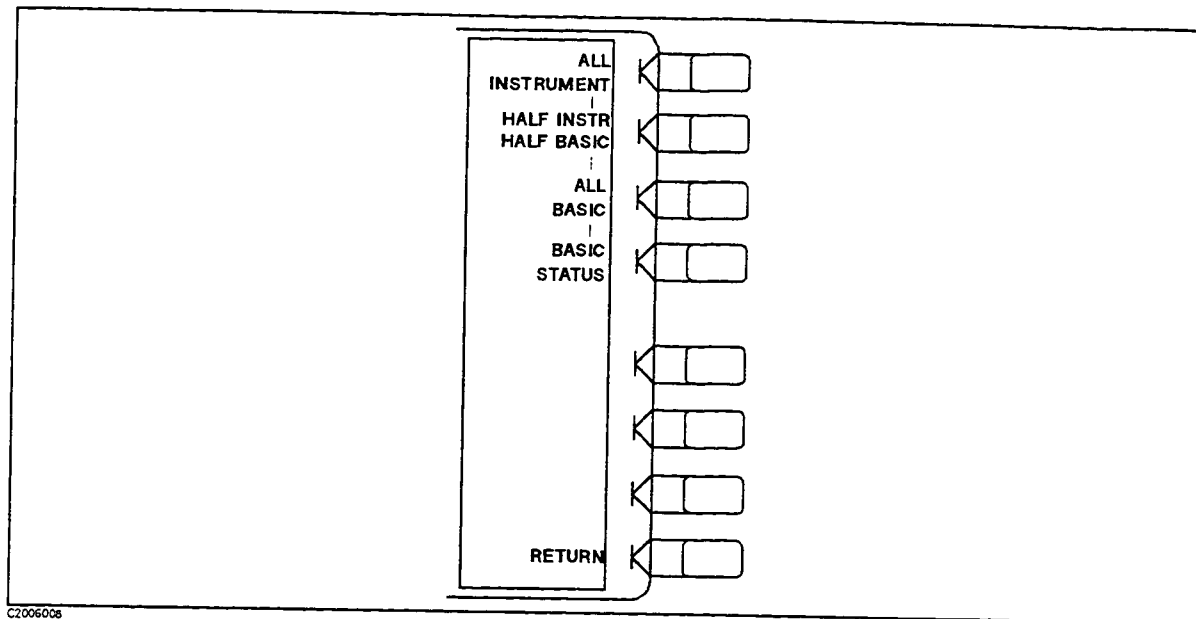

Figure 6-34. Display Allocation Menu

ALL INSTRUMENT (DISAALLI) selects a full screen single screen or two half-screen graticules.

HALF INSTR HALF BASIC (DISAHIHB) selects two half-screens, one graticule display above the Instrument BASIC display.

ALL BASIC (DISAALLB) selects a full screen single Instrument BASIC display.

BASIC STATUS (DISABASS) selects a full screen graticule and three status lines for Instrument BASIC under the graticule.

RETURN goes back to the display menu.

Trace Math Menu

The analyzer has two available memory traces, one per channel. Memory traces are totally channel dependent: channel 1 cannot access the channel 2 memory trace or vice versa. Memory traces can be saved with the built-in FDD: one memory trace can be saved per channel per saved file on a disk. The memory data is stored as double precision, complex data. Refer to Chapter 11.

Two trace math operations are available, data/memory and data-memory. (Note that normalization is data/memory not data-memory.) Trace math is done immediately after error correction. This means that any data processing done after error correction, including parameter conversion, scaling, etc., can be performed on the memory trace. (Refer to "DATA PROCESSING" in Chapter 1.) Trace math can also be used as a simple means of error correction, although that is not its main purpose.

The memory trace is cleared on instrument preset, power on, or instrument state recall.

If sweep mode, sweep range or number of points is different between the data and memory traces, trace math is allowed, and no warning message is displayed.

If trace math or display memory is requested and no memory trace exists, the message "CAUTION: NO VALID MEMORY TRACE" is displayed.

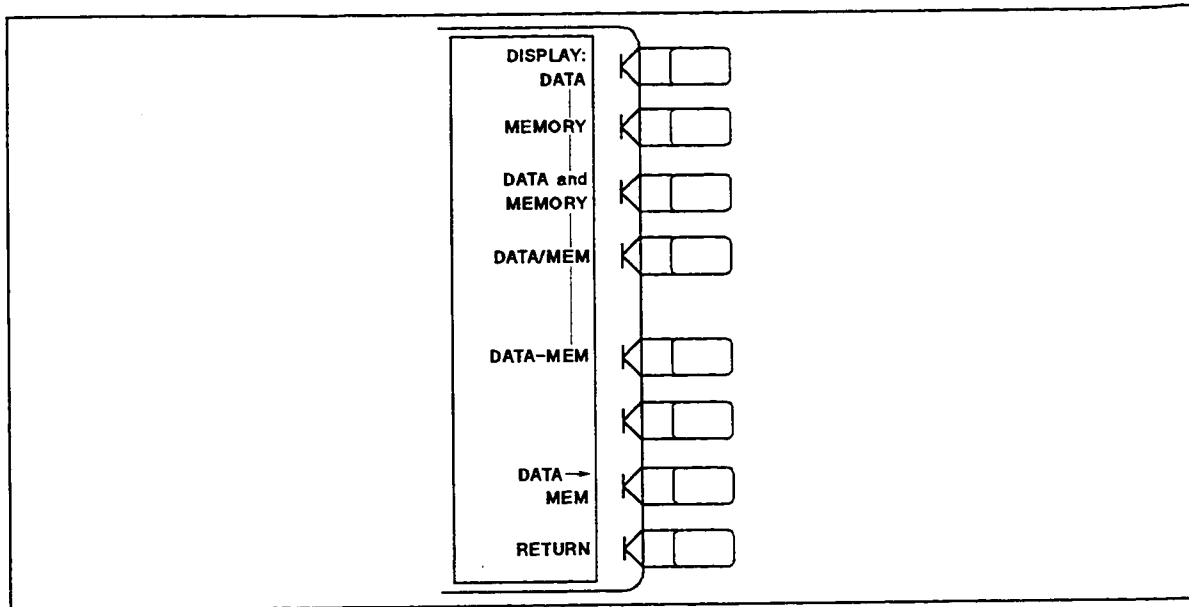

CZ006009

Figure 6-35. Trace Math Menu

DISPLAY: DATA (DISPDATA) displays the current measurement data trace for the active channel.

MEMORY (DISPMEMO) displays the trace memory for the active channel. If no data has been stored in memory for this channel, a warning message is displayed.

DATA and MEMORY (DISPDATM) displays both the current data and the memory traces.

DATA/MEM (DISPDMM) divides the data by the memory, normalizing the data to the memory, and displays the result. This is useful for ratio comparison of two traces, for instance in measurements of gain or attenuation.

DATA-MEM (DISPDMM) subtracts the memory from the data. The vector subtraction is performed on the complex data. This is appropriate for storing a measured vector error, for example directivity, and later subtracting it from the device measurement.

DATA → MEM (DATI) stores the current active measurement data in the memory of the active channel. It then becomes the memory trace, for use in subsequent math manipulations or display.

RETURN goes back to the display menu.

Title Menu

Use this menu to specify a title for the active channel. The title identifies the display regardless of stimulus or response changes, and is printed or plotted with the data.

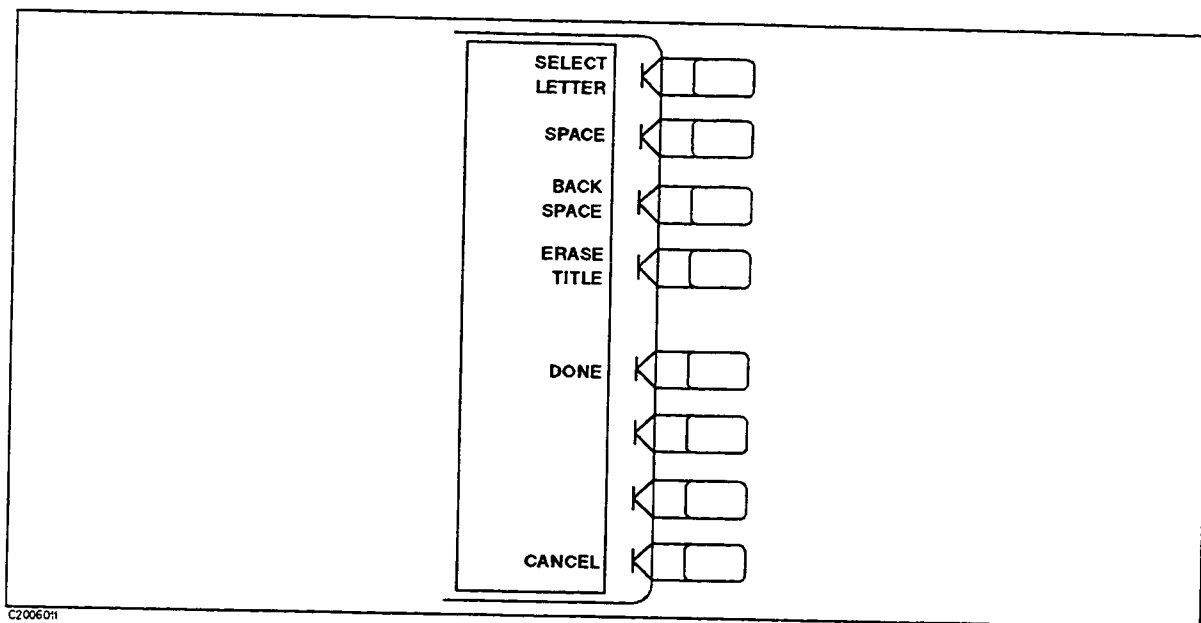



Figure 6-36. Title Menu

SELECT LETTER The active entry area displays the letters of the alphabet, digits 0 through 9, and some special characters including mathematical symbols. Three sets of letters can be scrolled using the step keys,  and . To define a title, press step keys for the desired letter set, rotate the knob until the arrow “↑” points at the first letter, then press **SELECT LETTER**. As each letter is selected, it is appended to the title at the top of the graticule. Repeat this until the complete title is defined, a maximum of 53 letters. It is also possible to input the letters from the keyboard provided with Instrument BASIC (Option 002).

SPACE inserts a space in the title.

BACK SPACE deletes the last character entered.

ERASE TITLE deletes the entire title.

DONE terminates the title entry, and returns to the display more menu.

CANCEL cancels the title entry and returns to the display more menu without any change.

Conjugate Matching Menu

This menu selects a proper matching circuit and calculates the device parameters in the selected matching circuit.

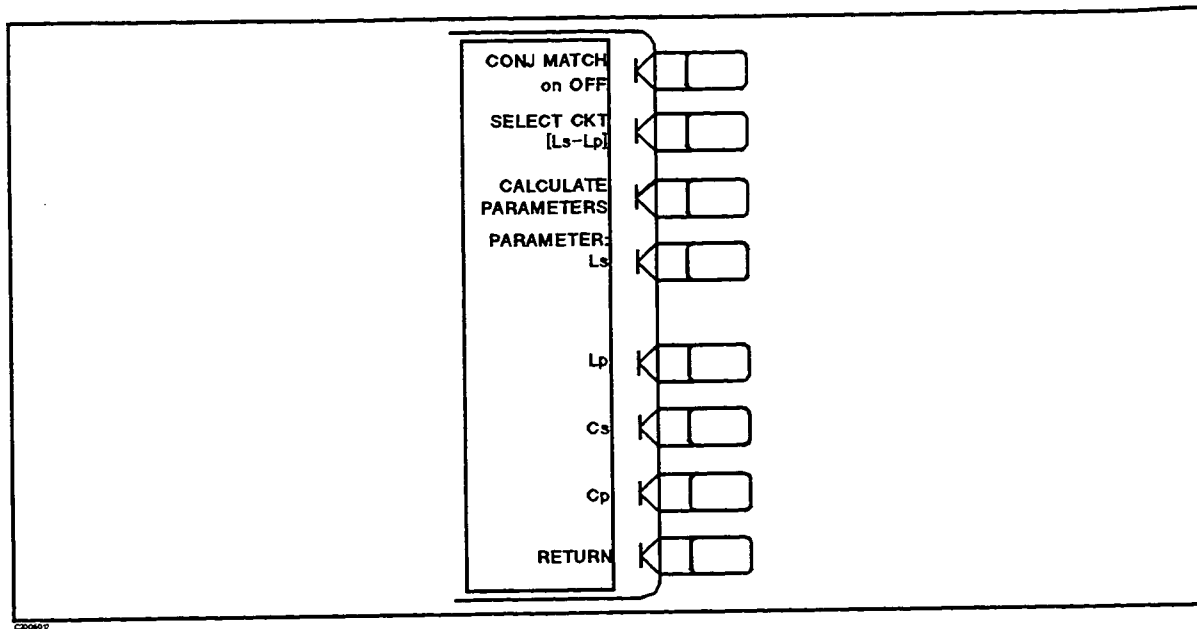

Figure 6-37. Conjugate Matching Menu

The conjugate matching function is useful for obtaining optimum power transfer, in other words, maximum return loss, at a specific frequency point.

According to the DUT's reflection characteristics at the active marker frequency on the Smith chart, a matching (conjugate) circuit is selected from among the eight provided circuit types shown in Figure 6-38, and the device parameters of this circuit is calculated. This two-element matching circuit matches the DUT's input impedance to the system impedance Z_0 (for example 50Ω). The reflection characteristics for the matched DUT is simulated and displayed.

Other possible circuits can also be selected and the parameters calculated.

In addition, the calculated parameters can be modified for commercially available values for example and the respective characteristics are calculated and displayed automatically.

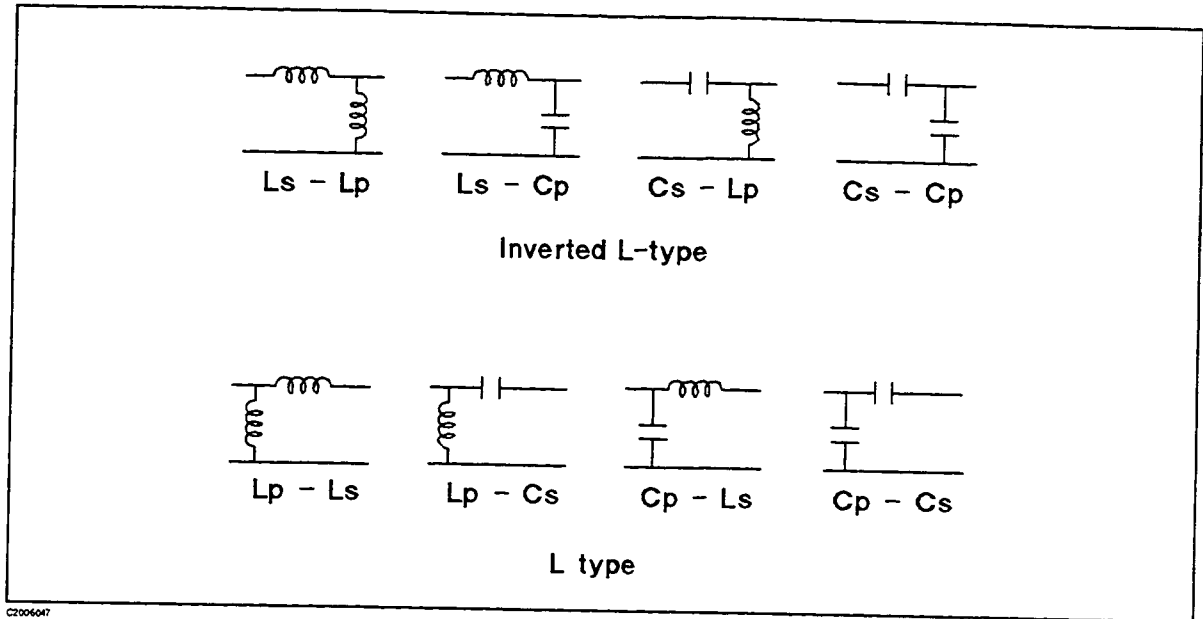

Figure 6-38. Matching Circuits

CONJ MATCH on OFF (COMMON, CONMOFF) toggles the conjugate matching ON or OFF.

SELECT CKT [Ls-Lp] (SELEC) brings up the select circuit menu to select a current matching circuit for conjugate matching.

CALCULATE PARAMETERS (CALP) calculates the parameters of the selected matching circuit. Make sure the display format is the Smith chart when pressing this softkey.

PARAMETER:Ls (CONPLS) displays or changes the parameter value "Ls" for the selected matching circuit.

Lp (CONPLP) displays or changes the parameter value "Lp" for the selected matching circuit.

Cs (CONPCS) displays or changes the parameter value "Cs" for the selected matching circuit.

Cp (CONPCP) displays or changes the parameter value "Cp" for the selected matching circuit.

RETURN goes back to the display more menu.

Select Circuit Menu

This selects the matching circuit from among the eight circuit types. A "*" is displayed on the left side of the softkeys of circuits which can match the impedance at the frequency position of the active marker.

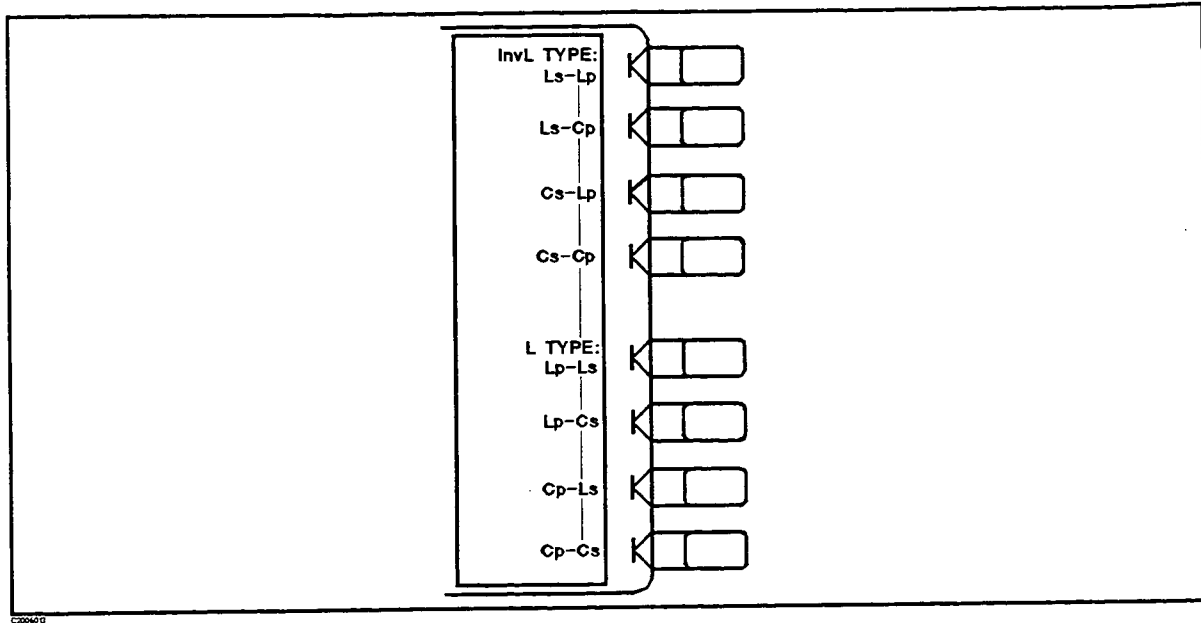

Figure 6-39. Select Circuit Menu

InvL TYPE: Ls-Lp (SELCLS \overline{L} P) selects the "Ls-Lp" circuit for the conjugate matching.

Ls-Cp (SELECLSCP) selects the "Ls-Cp" circuit for the conjugate matching.

Cs-Lp (SELECCSLP) selects the "Cs-Lp" circuit for the conjugate matching.

Cs-Cp (SELECCSCP) selects the "Cs-Cp" circuit for the conjugate matching.

L TYPE: Lp-Ls (SELECLPLS) selects the "Lp-Ls" circuit for the conjugate matching.

Lp-Cs (SELECLPCS) selects the "Lp-Cs" circuit for the conjugate matching.

Cp-Ls (SELECCPLS) selects the "Cp-Ls" circuit for the conjugate matching.

Cp-Cs (SELECCPCS) selects the "Cp-Cs" circuit for the conjugate matching.

Adjust Display Menu

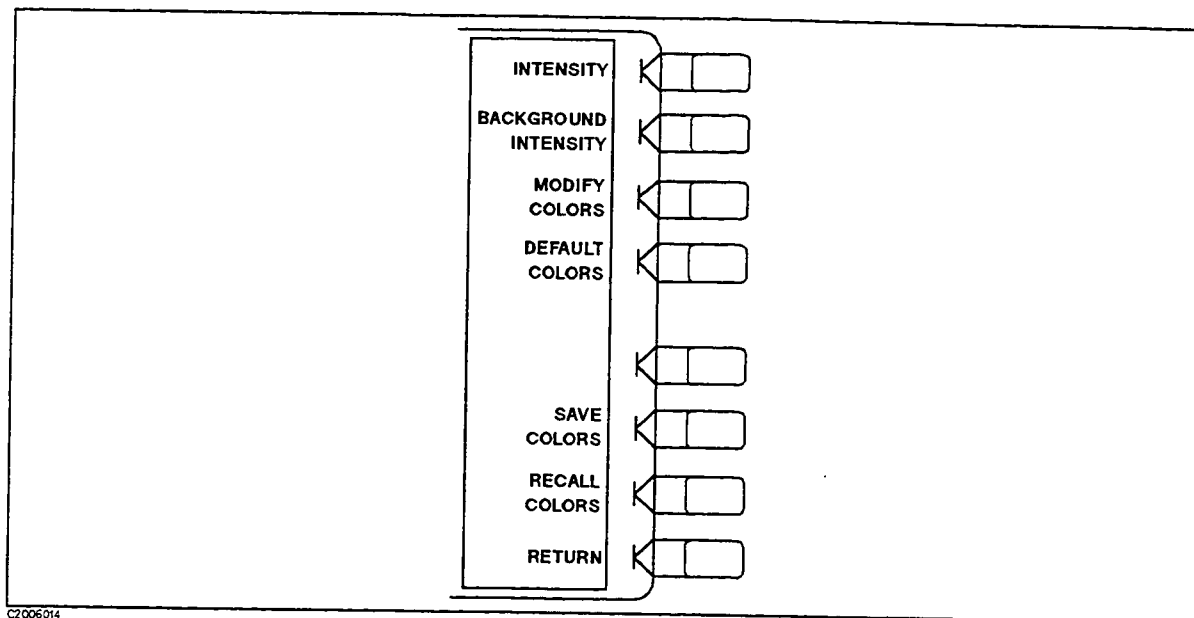

Figure 6-40. Adjust Display Menu

INTENSITY (INTE) sets the display intensity as a percent of the brightest setting.

BACKGROUND INTENSITY (BACI) sets the background intensity of the display as a percent of the white level.

MODIFY COLORS present the modify colors menu for color modification of display elements. Refer to Adjusting Color later in this chapter for information on modifying display elements.

DEFAULT COLORS (DEFC) returns all the color settings back to the factory-set default values.

SAVE COLORS (SVC0) saves the modified version of the color set to the non-volatile memory.

RECALL COLORS (RECC) recalls the previously saved modified version of the color set from the non-volatile memory. This key appears only when a color set has been saved.

RETURN goes back to the display more menu.

Modify Colors Menu

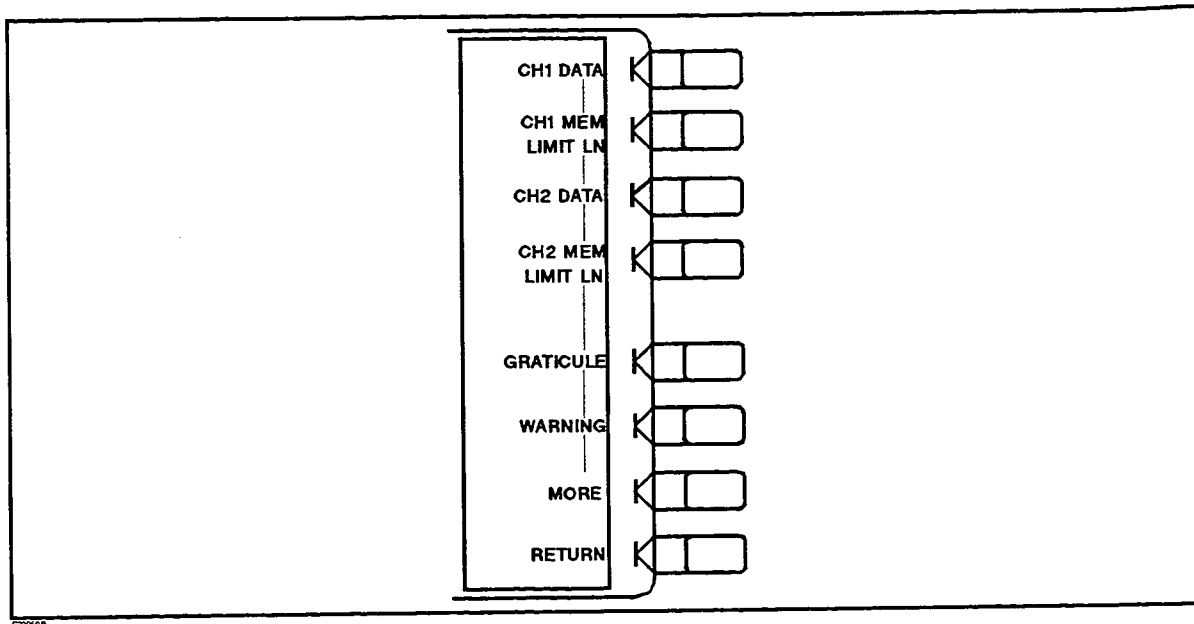

Figure 6-41. Modify Colors Menu

CH1 DATA (COLOCH1D) selects channel 1 data trace for color modification.

CH1 MEM LIMIT LN (COLOCH1M) selects channel 1 memory trace and limit line for color modification.

CH2 DATA (COLOCH2D) selects channel 2 data trace for color modification.

CH2 MEM LIMIT LN (COLOCH2M) selects channel 2 memory and the reference line and limit line for color modification.

GRATICULE (COLOGRAT) selects the graticule and a portion of softkey text (where there is a choice of a feature being ON or OFF) for color modification.

WARNING (COLOWARN) selects the warning annotation for color modification.

MORE leads to the Modify Colors More menu. This softkey is for Option 002 only. If Option 002 is not installed in the analyzer, the **TEXT** softkey is displayed instead of the **MORE** softkey. The **TEXT** softkey is explained in Modify Colors More menu.

RETURN goes back to the adjust display menu.

Modify Colors More Menu (Option 002 only)

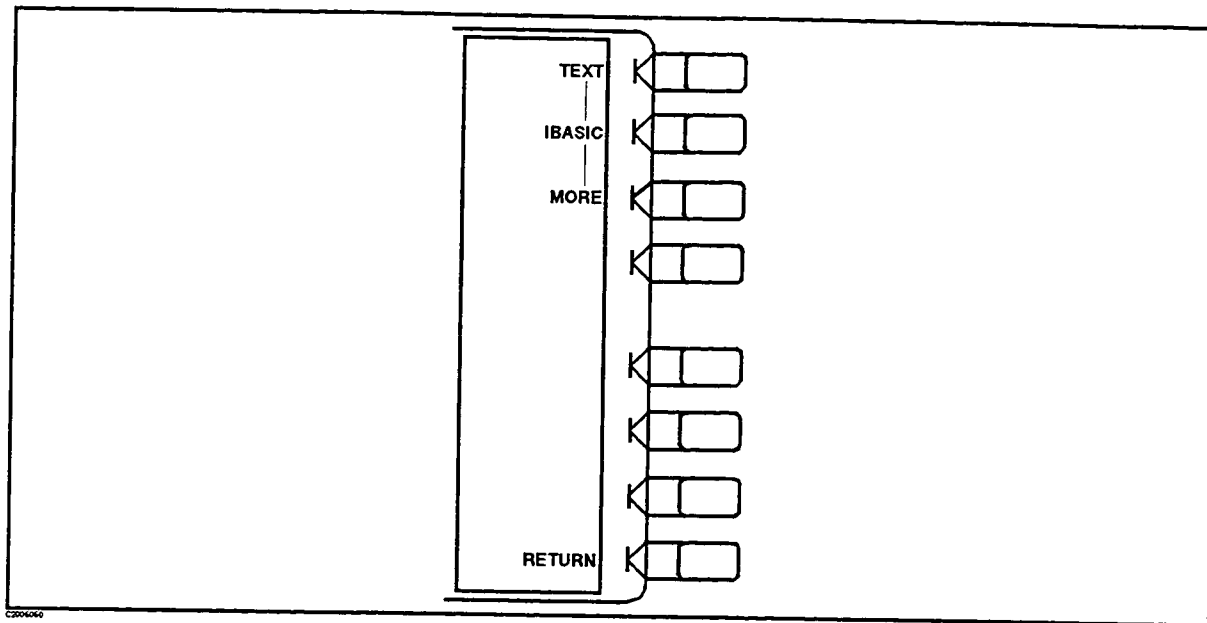

Figure 6-42. Modify Colors More Menu

TEXT (COLOTEXT) selects all the non-data text for color modification. For example: softkey labels. If Option 002 is not installed in the analyzer, the **TEXT** softkey is displayed in the Modify Colors Menu instead of the **MORE** softkey.

IBASIC (COLOIBT) selects the text on the BASIC screen for color modification.

MORE leads to the Pen menu.

Pen Menu (Option 002 only)

This selects a numbered pen for color modification. The pens are used by the HP Instrument BASIC graphic commands.

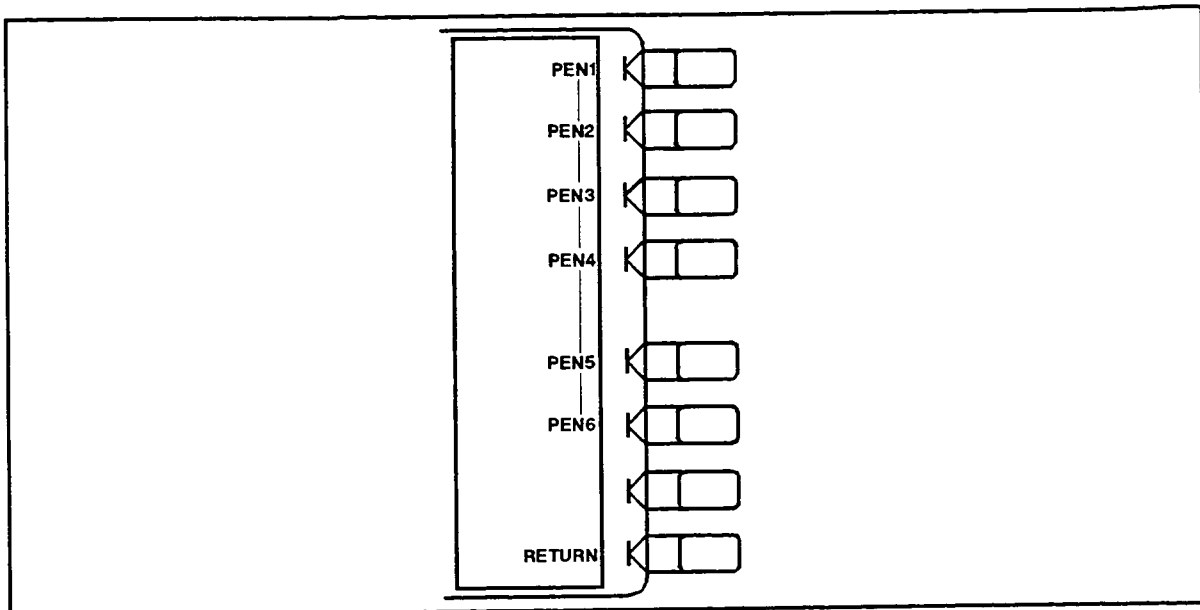

Figure 6-43. Pen Menu

PEN1 (COLOPEN1) selects pen 1 for color modification.

PEN2 (COLOPEN2) selects pen 2 for color modification.

PEN3 (COLOPEN3) selects pen 3 for color modification.

PEN4 (COLOPEN4) selects pen 4 for color modification.

PEN5 (COLOPEN5) selects pen 5 for color modification.

PEN6 (COLOPEN6) selects pen 6 for color modification.

RETURN goes back to the Adjust Display menu.

Color Adjust Menu

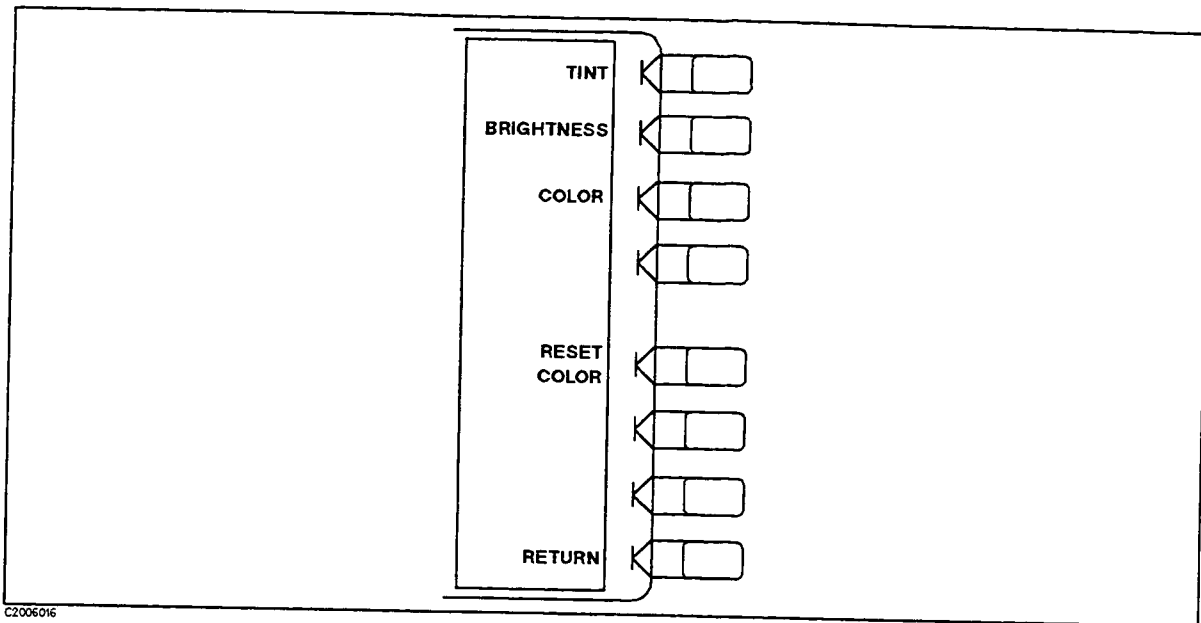

Figure 6-44. Color Adjust Menu

TINT (TINT) adjusts the hue of the chosen attribute. See Adjusting Color for an explanation of using this softkey for color modification of display attributes.

BRIGHTNESS (CBRI) adjusts the brightness of the color being modified. See Adjusting Color for an explanation of using this softkey for color modification of display attributes.

COLOR adjusts the degree of whiteness of the color being modified. See Adjusting Color for an explanation of using this softkey for color modification of display attributes.

RESET COLOR (RSC0) resets the color being modified to the default color.

RETURN goes back to the modify colors menu.

Adjusting Color

This procedure explains how to adjust the colors on the analyzer display. The default colors in this instrument have been scientifically chosen to maximize your ability to discern the difference between the colors, and to comfortably and effectively view the colors. These colors are recommended for normal use because they will provide a suitable contrast that is easy to view for long period of time.

You may want to change colors to suit environmental needs, individual preferences, or to accommodate color deficient vision. You can use any of the available colors for any of the nine display elements listed by the softkey names below:

- CH1 DATA
- CH1 MEM LIMIT LN
- CH2 DATA

- CH2 MEM LIMIT LN
- GRATICULE
- WARNING
- TEXT
- IBASIC
- PEN

To change the color of a display element, press the softkey for that element (such as CH1 DATA). Then press TINT and turn the knob until the desired color appears. The step keys or numeric keypad can also be used.

Color is comprised of three parameters:

Tint The continuum of hues on the color wheel, ranging from red through green and blue, and back to red.

Brightness A measure of the brightness of the color.

Color The degree of whiteness of the color. A scale from white to pure color.

The most frequently occurring color deficiency is the inability to distinguish red, yellow, and green from one another. Confusion between these colors can usually be eliminated by increasing the brightness between the colors. To do this, press the BRIGHTNESS softkey and turn the knob. If adjustment is needed, vary the degree of whiteness of the color. To do this, press the COLOR softkey and turn the knob.

Note  Color changes and adjustments remain in effect until changed again in these menus or the analyzer is turned off. Preset and instrument state recall do not affect the selected colors.

Setting Default Colors

To set all the display elements to the factory-defined default colors, press:

DISPLAY MORE ADJUST DISPLAY DEFAULT COLORS

Saving Modified Colors

To save the modified color set to the non-volatile memory, press:

DISPLAY MORE ADJUST DISPLAY SAVE COLORS

Modified colors are not part of a saved instrument state and are lost unless saved using these softkeys.

Recalling Modified Colors

To recall the previously saved color set from the non-volatile memory, press:

DISPLAY MORE ADJUST DISPLAY RECALL COLORS

AVG Key

AVG KEY

The HP-IB programming command is shown in parenthesis following the key or softkey.

The **AVG** key accesses four different noise reduction techniques: sweep-to-sweep averaging, display smoothing, variable IF bandwidth, and group delay aperture for group delay measurement. Any or all of these can be used simultaneously. Averaging, smoothing and group delay aperture can be set independently for each channel, and the IF bandwidth can be set independently if the stimulus is uncoupled.

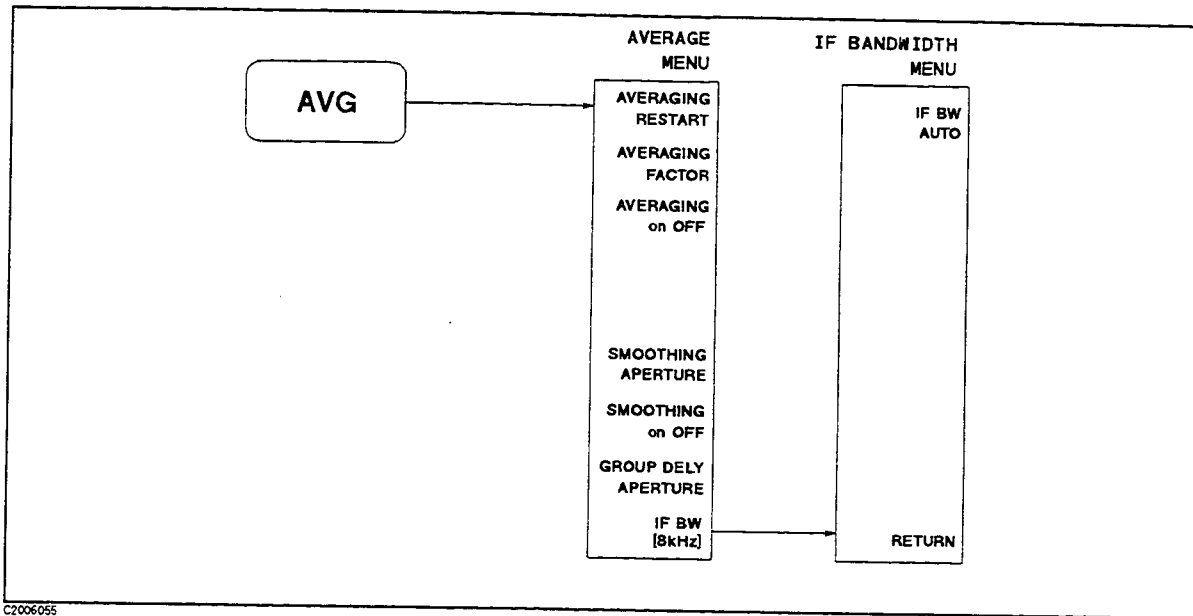

Figure 6-45. Softkey Menus Accessed from the **AVG** Key

Averaging

Averaging computes each data point based on an exponential average of consecutive sweeps weighted by a user-specified averaging factor. Each new sweep is averaged into the trace until the total number of sweeps is equal to the averaging factor, for a fully averaged trace. Each point on the trace is the vector sum of the current trace data and the data from the previous sweep. A high averaging factor gives the best signal-to-noise ratio, but slows the trace update time. Doubling the averaging factor reduces the noise by 3 dB. Figure 6-46 illustrates the effect of averaging on a log magnitude format trace.

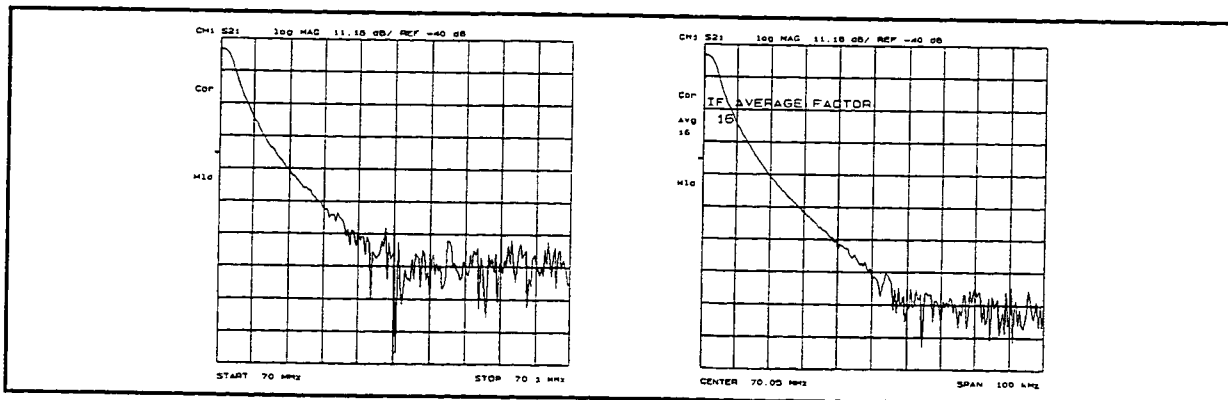

Figure 6-46. Effect of Averaging on a Trace

Smoothing

Smoothing (similar to video filtering) averages the formatted active channel data over a portion of the displayed trace. Smoothing computes each displayed data point based on one sweep only, using a moving average of several adjacent data points for the current sweep. The smoothing aperture is a percent of the stimulus span swept, up to a maximum of 100%.

Rather than lowering the noise floor, smoothing finds the mid-value of the data. Use it to reduce relatively small peak-to-peak noise values on broadband measured data. Use a sufficiently high number of display points to avoid misleading results. Do not use smoothing for measurements of high Q resonant devices or other devices with wide variations in the trace, as it will introduce errors into the measurement.

In polar display format, large phase shifts over the smoothing aperture will cause shifts in amplitude, since a vector average is being computed. Figure 6-47 illustrates the effect of smoothing on a log magnitude format trace.

If data and memory traces are displayed, smoothing is performed on both of them.

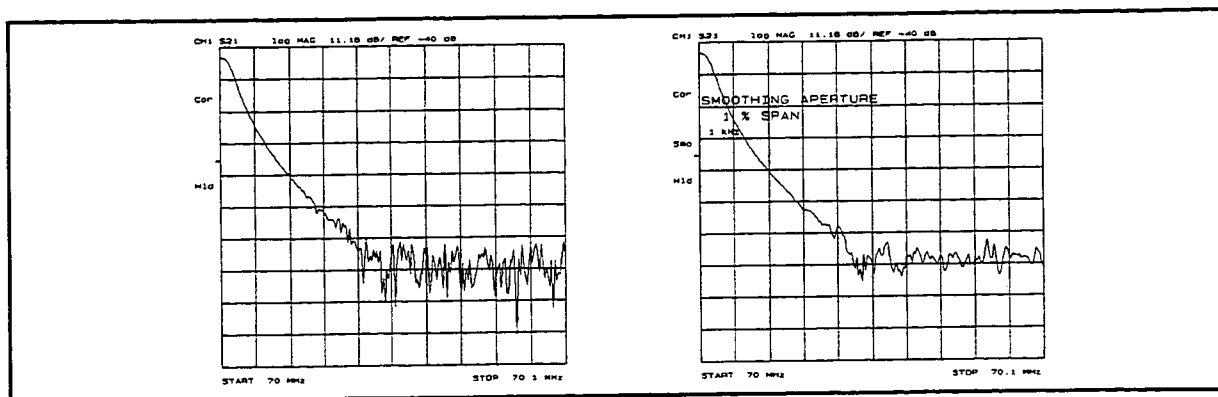

Figure 6-47. Effect of Smoothing on a Trace

IF Bandwidth Reduction

IF Bandwidth Reduction lowers the noise floor by reducing the receiver input bandwidth. It has an advantage over averaging in reliably filtering out unwanted responses such as spurs, odd harmonics, higher frequency spectral noise, and line-related noise. Sweep-to-sweep averaging, however, is better at filtering out very low frequency noise. A tenfold reduction in IF bandwidth (from 200 Hz to 20 Hz, for example) lowers the measurement noise floor by about 10 dB.

Another difference between sweep-to-sweep averaging and variable IF bandwidth is the sweep time. Averaging displays the first complete trace faster but takes several sweeps to reach a fully averaged trace. IF bandwidth reduction lowers the noise floor in one sweep, but the sweep time may be slower. Figure 6-48 illustrates the difference in noise floor between a trace measured with a 1 kHz IF bandwidth and with a 2 Hz IF bandwidth.

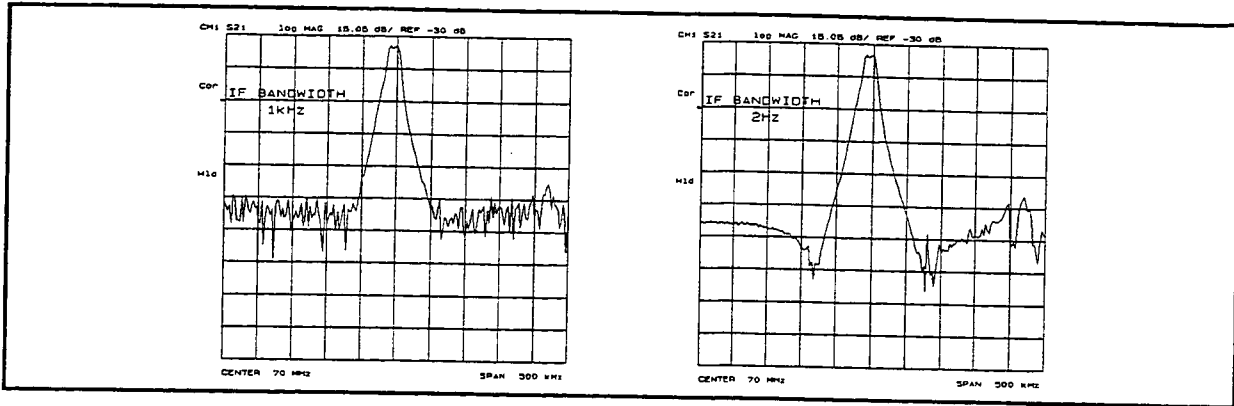

Figure 6-48. IF Bandwidth Reduction

Group Delay Aperture

Changing group delay aperture will lower the noise on the group delay trace. Refer to Group Delay Principles earlier in this chapter.

Another capability that can be used for effective noise reduction is the marker statistics function, which computes the average value of part or all of the formatted trace. Refer to Chapter 8.

Average Menu

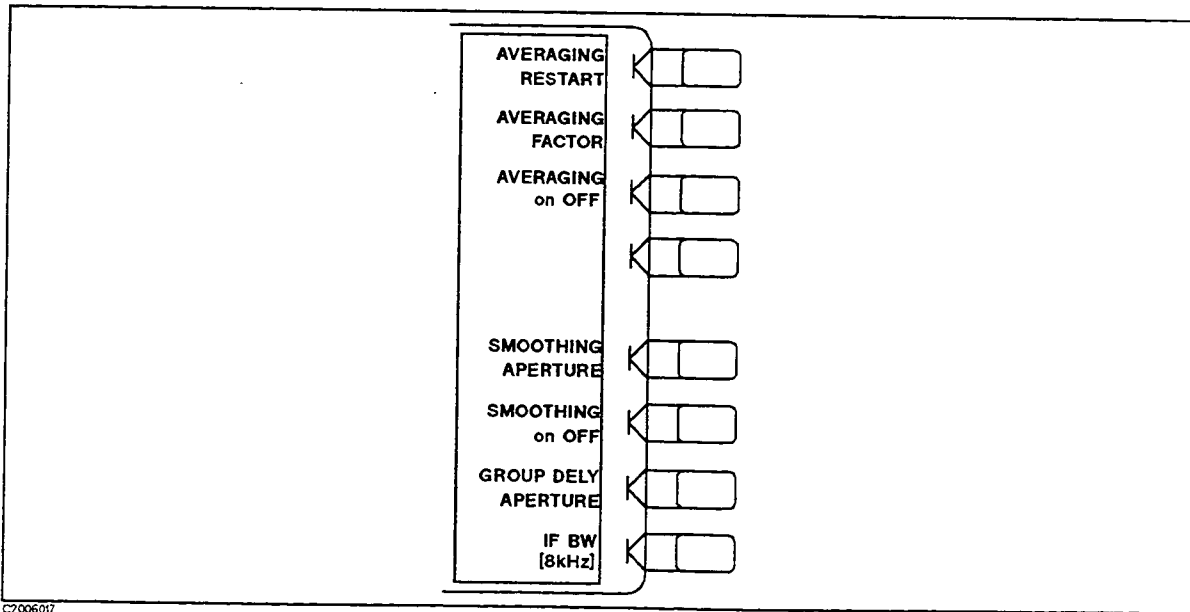

Figure 6-49. Average Menu

AVERAGING RESTART (AVERREST) resets the sweep-to-sweep averaging and restarts the sweep count at 1 at the beginning of the next sweep. The sweep count for averaging is displayed at the left of the display.

AVERAGING FACTOR (AVERFACT) makes averaging factor the active function. Any value up to 999 can be used. The algorithm used for averaging is:

$$A_{(n)} = \frac{S_{(n)}}{F} + \left(1 - \frac{1}{F}\right) \times A_{(n-1)}$$

where

A(n) = current average

S(n) = current measurement

F = average factor

AVERAGING on OFF (AVERON, AVEROFF) turns the averaging function ON or OFF for the active channel. "Avg" is displayed in the status notations area at the left of the display, together with the sweep count for the averaging factor, when averaging is ON. The sweep count for averaging is reset to 1 whenever an instrument state change affecting the measured data is made.

At the start of averaging or following **AVERAGING RESTART**, averaging starts at 1 and averages each new sweep into the trace until it reaches the specified averaging factor. The sweep count is displayed in the status notations area below "Avg" and updated every sweep as it increments. When the specified averaging factor is reached, the trace data continues to be updated, weighted by that averaging factor.

SMOOTHING APERTURE (SMOOPER) lets you change the value of the smoothing aperture as a percent of the span. When smoothing aperture is the active function, its value in stimulus units is displayed below its percent value in the active entry area. Allowed range is 0.05 through 100 % of span and resolution is 0.001%.

SMOOTHING on OFF (SMOON, SMOOFF) turns the smoothing function ON or OFF for the active channel. When smoothing is ON, the annotation "Smo" is displayed in the status notations area. The algorithm used for smoothing is:

$$S_{m(n)} = \frac{D_{(n-m)} + \dots + D_{(n)} + \dots + D_{(n+m)}}{2m + 1}$$

where

Sm(n) = smoothed data

D(n) = unsmoothed data

m : decided from smoothing aperture

GROUP DELAY APERTURE (GRODAPER) sets the aperture for group delay measurements as a percent of the span (refer to Group Delay Principles earlier in this chapter). A frequency aperture Δf at the active marker is displayed under the percent value when the format is DELAY.

IF BW (IFBW) selects the bandwidth value for IF bandwidth reduction. Allowed values (in Hz) are 4 k, 1 k, 200, 20, and 2. Any other value will default to the closest allowed value. A narrow bandwidth slows the sweep speed but provides better signal-to-noise ratio. The selected bandwidth value is shown in brackets in the softkey label.

IF Bandwidth Menu

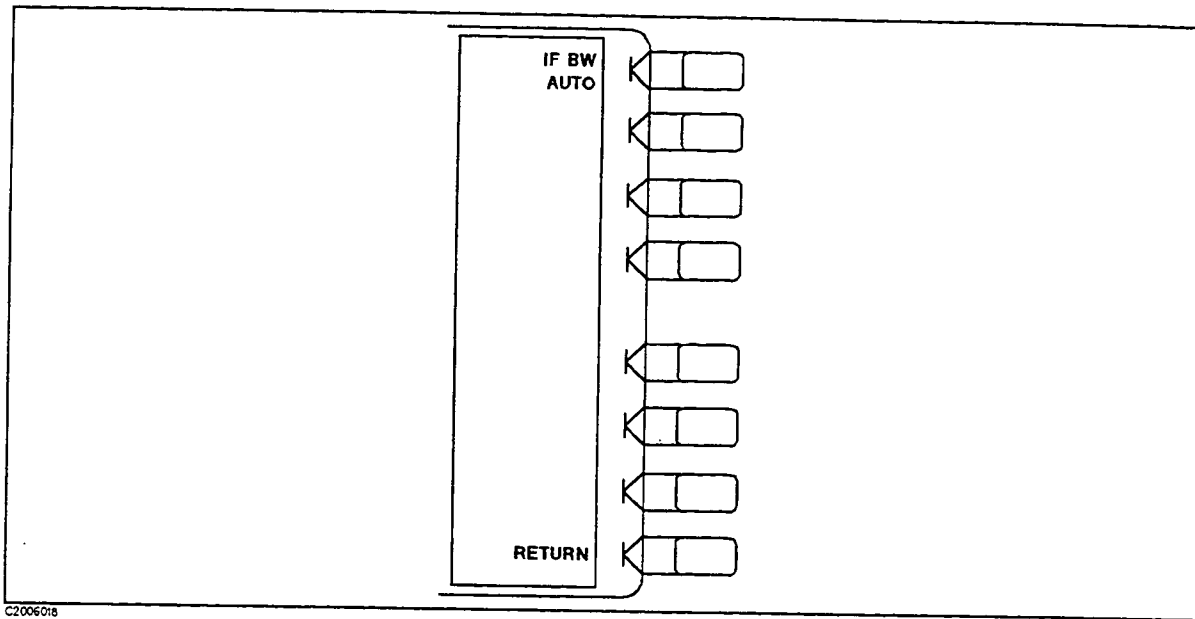

Figure 6-50. IF Bandwidth Menu

IF BW AUTO (IFBWAUTO) selects the proper IF bandwidth automatically for each measurement point while the measuring frequency is swept. This is convenient for getting fast and good performance when the log frequency sweep type is selected.

The best bandwidth depends on the measuring frequency. The relations between measuring frequency and IF bandwidth are as follows:

Table 6-1. IF Bandwidth in AUTO mode

Frequency	IF Bandwidth
5 Hz to 199.999 Hz	2 Hz
200 Hz to 1.999 999 kHz	20 Hz
2 kHz to 99.999 999 kHz	200 Hz
100 kHz to 999.999 999 kHz	1 kHz
1 MHz to 500 MHz	4 kHz

RETURN goes back to the average menu.

ATTEN KEY

This key provides the attenuator menu which selects the analyzer's three internal attenuator values, 0 or 20 dB, for inputs A, B, and R.

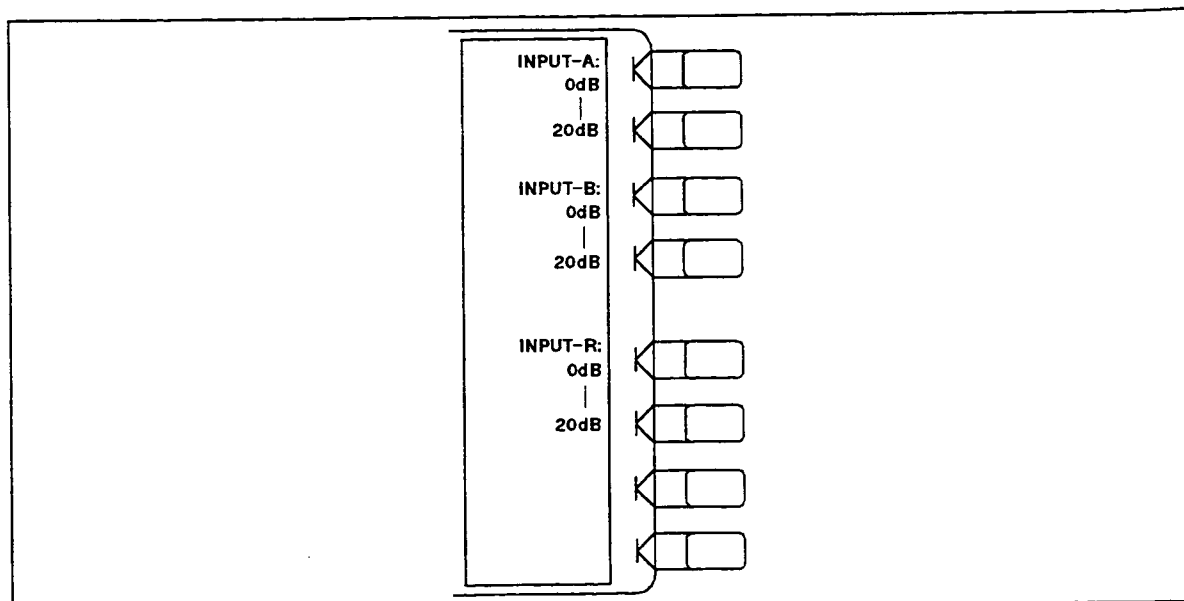
Attenuator Menu

C2006019

Figure 6-51. Attenuator Menu

INPUT-A: 0dB (ATTIA0DB) sets the attenuator in input A to 0 dB.

20dB (ATTIA20DB) sets the attenuator in input A to 20 dB.

INPUT-B: 0dB (ATTIB0DB) sets the attenuator in input B to 0 dB.

20dB (ATTIB20DB) sets the attenuator in input B to 20 dB.

INPUT-R: 0dB (ATTIRODB) sets the attenuator in input R to 0 dB.

20dB (ATTIR20DB) sets the attenuator in input R to 20 dB.

Measurement Calibration

INTRODUCTION

Measurement calibration is an accuracy enhancement procedure that effectively reduces the system errors that cause uncertainty in measuring a device under test. It measures known standard devices, and uses the results of these measurements to characterize the system.

This chapter explains the theoretical fundamentals of accuracy enhancement and the sources of measurement errors. It describes the different measurement calibration procedures available in the analyzer, which errors they correct, and the measurements for which each should be used. An appendix at the end of this chapter provides further information on characterizing systematic errors and using error models to analyze overall measurement performance.

ACCURACY ENHANCEMENT

If it were possible for a perfect measurement system to exist, it would have infinite dynamic range, isolation, and directivity characteristics, no impedance mismatches in any part of the test setup, and flat frequency response. Vector accuracy enhancement, also known as measurement calibration or error correction, provides the means to simulate a perfect measurement system.

In any high frequency measurement, there are measurement errors associated with the system that contribute uncertainty to the results. Parts of the measurement setup such as interconnecting cables and signal separation devices (as well as the analyzer itself) all introduce variations in magnitude and phase that can mask the actual performance of the device under test.

For example, crosstalk due to the channel isolation characteristics of the analyzer can contribute an error equal to the transmission signal of a high-loss test device. For reflection measurements, the primary limitation of dynamic range is the directivity of the test setup. The measurement system cannot distinguish the true value of the signal reflected by the device under test from the signal arriving at the receiver input due to leakage in the system. For both transmission and reflection measurements, impedance mismatches within the test setup cause measurement uncertainties that appear as ripples superimposed on the measured data.

Measurement calibration simulates a perfect analyzer system. It measures the magnitude and phase responses of known standard devices, and compares the measurement with actual device data. It uses the results to characterize the system and effectively remove the system errors from the measurement data of a test device, using vector math capabilities internal to the analyzer.

Sources of Measurement Errors

When measurement calibration is used, the dynamic range and accuracy of the measurement are limited only by system noise and stability, connector repeatability, and the accuracy to which the characteristics of the calibration standards are known.

SOURCES OF MEASUREMENT ERRORS

Network analysis measurement errors can be separated into systematic, random, and drift errors.

Correctable systematic errors are the repeatable errors that the system can measure. These are errors due to mismatch and leakage in the test setup, isolation between the reference and test signal paths, and system frequency response.

The system cannot measure and correct for the non-repeatable random and drift errors. These errors affect both reflection and transmission measurements. Random errors are measurement variations due to noise and connector repeatability. Drift errors include frequency drift, temperature drift, and other physical changes in the test setup between calibration and measurement.

The resulting measurement is the vector sum of the device under test response plus all error terms. The precise effect of each error term depends upon its magnitude and phase relationship to the actual test device response.

In most high frequency measurements the systematic errors are the most significant source of measurement uncertainty. Since each of these errors can be characterized, their effects can be effectively removed to obtain a corrected value for the test device response. For the purpose of vector accuracy enhancement these uncertainties are quantified as directivity, source match, load match, isolation (crosstalk), and frequency response (tracking). Each of these systematic errors is described below.

Random and drift errors cannot be precisely quantified, so they must be treated as producing a cumulative uncertainty in the measured data.

Directivity

Normally a device that can separate the reverse from the forward traveling waves (a directional bridge or coupler) detects the signal reflected from the device under test. Ideally the coupler would completely separate the incident and reflected signals, and only the reflected signal would appear at the coupled output, as illustrated in Figure 7-1-a.

Sources of Measurement Errors

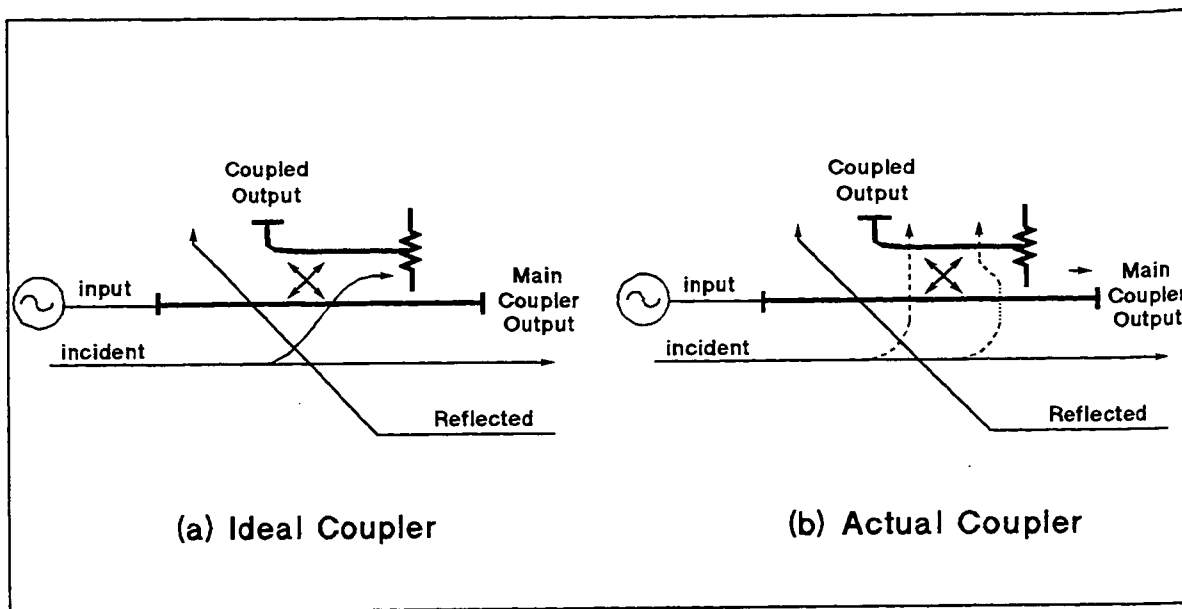

Figure 7-1. Directivity

However, an actual coupler is not perfect, as illustrated in Figure 7-1-b. A small amount of the incident signal appears at the coupled output due to leakage as well as to reflection from the termination in the coupled arm. Also, reflections from the main coupler output connector appear at the coupled output, adding uncertainty to the signal reflected from the device. The figure of merit for how well a coupler separates forward and reverse waves is directivity. The greater the directivity of the device, the better the signal separation. Directivity is the vector sum of all leakage signals appearing at the analyzer receiver input due to the inability of the signal separation device to absolutely separate incident and reflected waves, and to residual reflection effects of test cables and adapters between the signal separation device and the measurement plane. The error contributed by directivity is independent of the characteristics of the test device and it usually produces the major ambiguity in measurements of low reflection devices.

Source Match

Source match is defined as the vector sum of signals appearing at the analyzer receiver input due to the impedance mismatch at the test device looking back into the source. Source match is degraded by adapters and extra cables. A non-perfect source match leads to mismatch uncertainties that affect both transmission and reflection measurements. Source match is most often given in terms of return loss in dB: thus the larger the number, the smaller the error.

- In a reflection measurement, the source match error signal is caused by some of the reflected signal from the DUT being reflected from the source back toward the DUT and re-reflected from the DUT (Figure 7-2).
- In a transmission measurement, the source match error signal is caused by reflection from the test device that is re-reflected from the source.

Sources of Measurement Errors

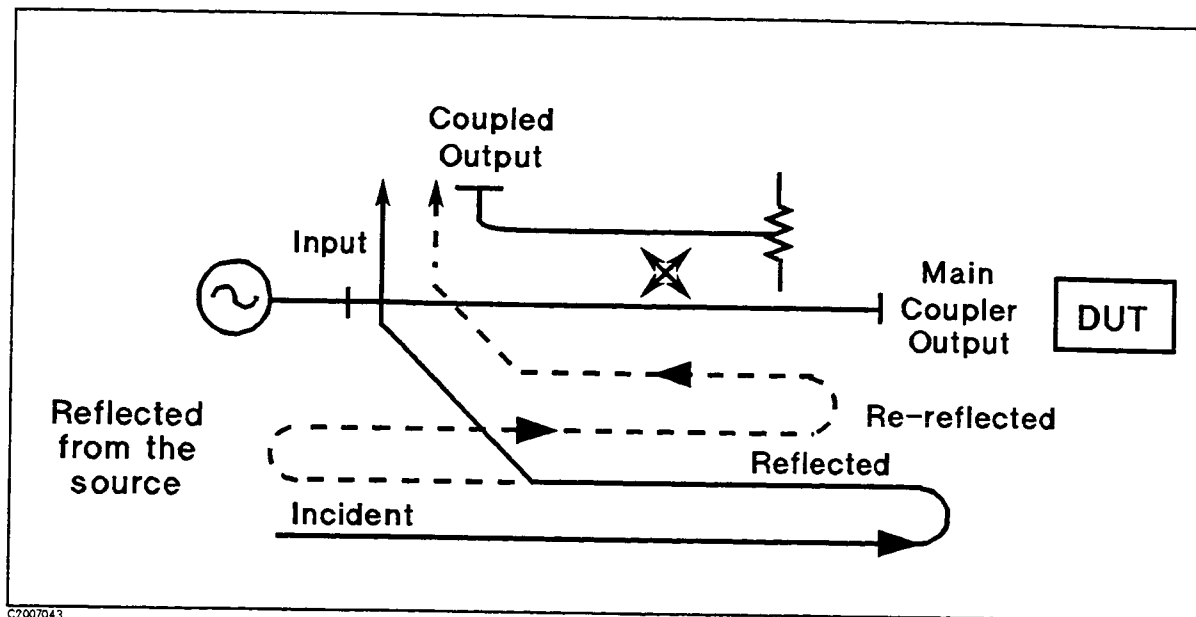

Figure 7-2. Source Match

The error contributed by source match is a mismatch error caused by the relationship between the actual input impedance of the test device and the equivalent match of the source. It is a factor in both transmission and reflection measurements. Mismatch uncertainty is particularly a problem in measurements where there is a large impedance mismatch at the measurement plane.

Load Match

Load match error results from an imperfect match at the output of the test device. It is caused by impedance mismatches between the test device output port and port 2 of the measurement system. As illustrated in Figure 7-3, some of the transmitted signal is reflected from port 2 back to the test device. A portion of this wave may be re-reflected to port 2, or part may be transmitted through the device in the reverse direction to appear at port 1. If the DUT has low insertion loss (for example a transmission line), the signal reflected from port 2 and re-reflected from the source causes a significant error because the DUT does not attenuate the signal significantly on each reflection. Load match is usually given in terms of return loss in dB: thus the larger the number, the smaller the error.

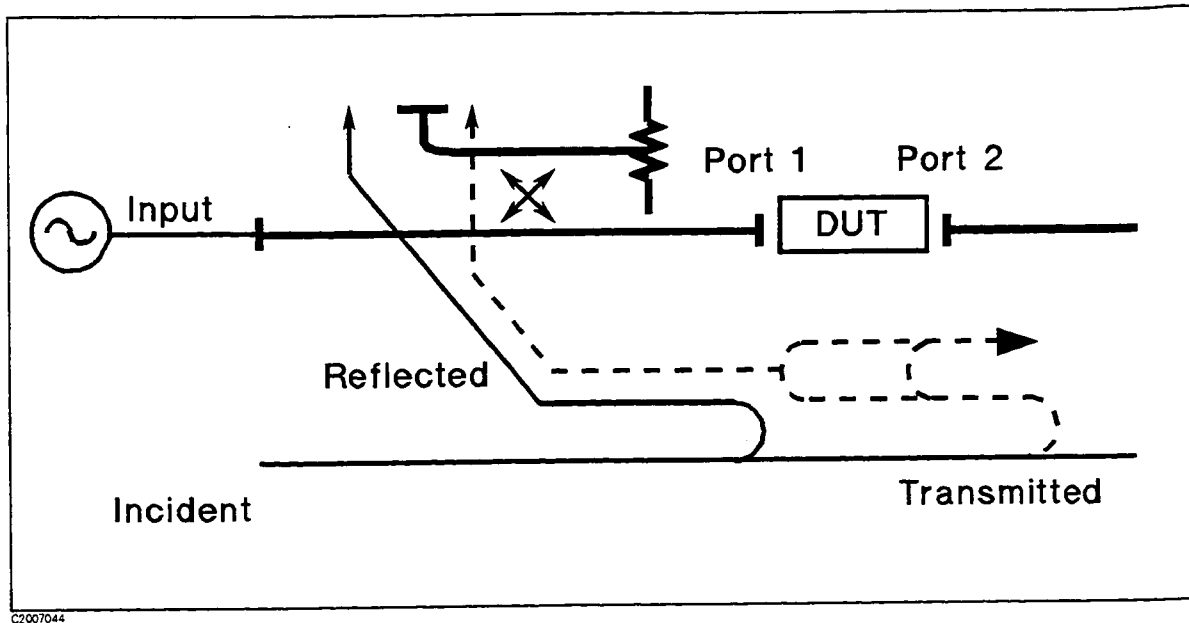

Figure 7-3. Load Match

The error contributed by load match depends on the relationship between the actual output impedance of the test device and the effective match of the return port (port 2). It is a factor in all transmission measurements and in reflection measurements of two-port devices. Load match and source match are usually ignored when the test device insertion loss is greater than about 6 dB, because the error signal is greatly attenuated each time it passes through the DUT. However, load match effects produce major transmission measurement errors for a test device with a highly reflective output port.

Isolation (Crosstalk)

Leakage of energy between analyzer signal paths contributes to error in a transmission measurement much like directivity does in a reflection measurement. Isolation is the vector sum of signals appearing at the analyzer receivers due to crosstalk between the reference and test signal paths, including signal leakage within the test set and in both the RF and IF sections of the receiver.

The error contributed by isolation depends on the characteristics of the device under test. Isolation is a factor in high-loss transmission measurements. However, analyzer system isolation is more than sufficient for most measurements, and correction for it may be unnecessary. For measuring devices with high dynamic range, accuracy enhancement can provide improvements in isolation that are limited only by the noise floor.

Correcting for Measurement Errors

Frequency Response (Tracking)

This is the vector sum of all test setup variations in which magnitude and phase change as a function of frequency. This includes variations contributed by signal separation devices, test cables, and adapters, and variations between the reference and test signal paths. This error is a factor in both transmission and reflection measurements.

For further explanation of systematic error terms and the way they are combined and represented graphically in error models, refer to the appendix at the end of this chapter, titled Accuracy Enhancement Fundamentals - Characterizing Systematic Errors.

CORRECTING FOR MEASUREMENT ERRORS

There are twelve different error terms for a two-port measurement that can be corrected by accuracy enhancement in the analyzer. These are directivity, source match, load match, isolation, reflection tracking, and transmission tracking, each in both the forward and reverse direction. The analyzer has several different measurement calibration routines to characterize one or more of the systematic error terms and remove their effects from the measured data. The procedures range from a simple frequency response calibration to a full two-port calibration that effectively removes all twelve error terms.

The **Response Calibration** effectively reduces the frequency response errors of the test setup for reflection or transmission measurements. This calibration procedure may be adequate for measurement of well matched low-loss devices. This is the simplest error correction to perform, and should be used when extreme measurement accuracy is not required.

The **Response and Isolation Calibration** effectively removes frequency response and crosstalk errors in transmission measurements, or frequency response and directivity errors in reflection measurements. This procedure may be adequate for measurement of well matched high-loss devices.

The **S₁₁ and S₂₂ One-Port Calibration** procedures provide directivity, source match, and frequency response vector error correction for reflection measurements. These procedures provide high accuracy reflection measurements of one-port devices or properly terminated two-port devices.

The **Full Two-Port Calibration** provides directivity, source match, load match, isolation, and frequency response vector error correction, in both forward and reverse directions, for transmission and reflection measurements of two-port devices. This calibration provides the best magnitude and phase measurement accuracy for both transmission and reflection measurements of two-port devices, and requires an S-parameter test set.

The **One-Path Two-Port Calibration** provides directivity, source match, load match, isolation, and frequency response vector error correction in one direction. It is used for high accuracy transmission and reflection measurements using a transmission/reflection test kit, such as the HP 87512A, B. (The device under test must be manually reversed between sweeps to accomplish measurements in both the forward and reverse directions.)

All the calibration procedures described above are accessed from the **CAL** key and are described in the following pages.

The uncorrected performance of the analyzer is sufficient for many measurements. However, the vector accuracy enhancement techniques described in this chapter will provide a much

Correcting for Measurement Errors

higher level of accuracy. Figure 7-4, and Figure 7-5 illustrate the improvements that can be made in measurement accuracy by using a more complete calibration routine. Figure 7-4 shows a measurement in log magnitude format with a response calibration only, and the improvement in the same measurement using an S_{11} one-port calibration.

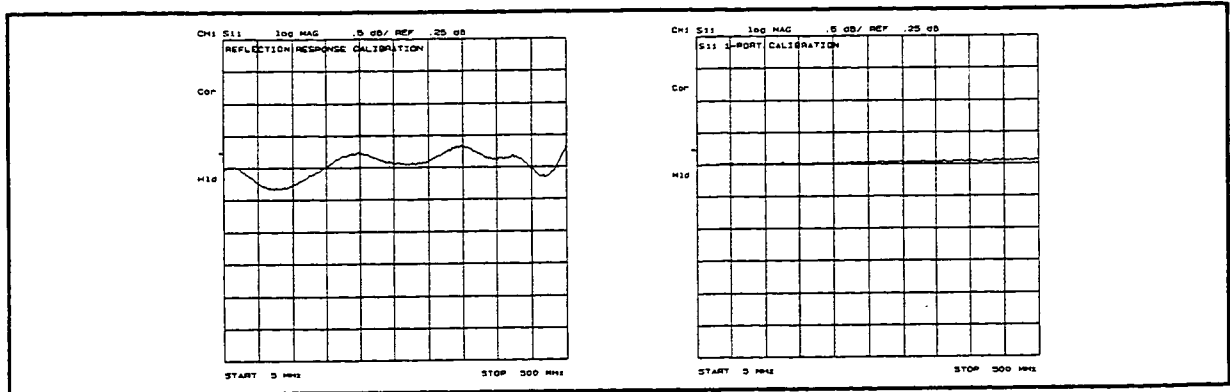

Figure 7-4. Response vs. S_{11} 1-Port Calibration on Log Magnitude Format

Figure 7-5 shows the response of a low-loss device in a log magnitude format, using a response calibration and a full two-port calibration.

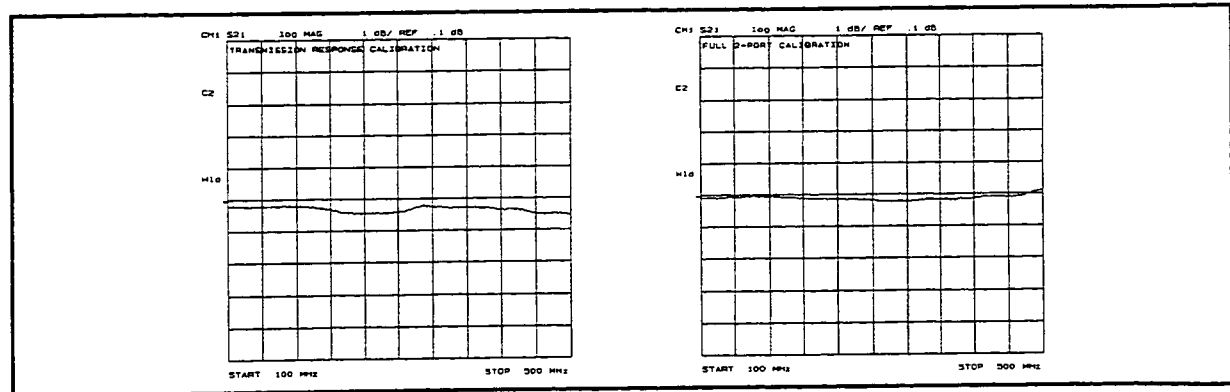

Figure 7-5. Response vs. Full Two-Port Calibration

After the correctable systematic errors are effectively removed using accuracy enhancement, residual uncertainties remain. In addition to random and drift errors, these include residual systematic errors resulting from imperfections in the calibration standards, the connector interface, the interconnecting cables, and the instrumentation.

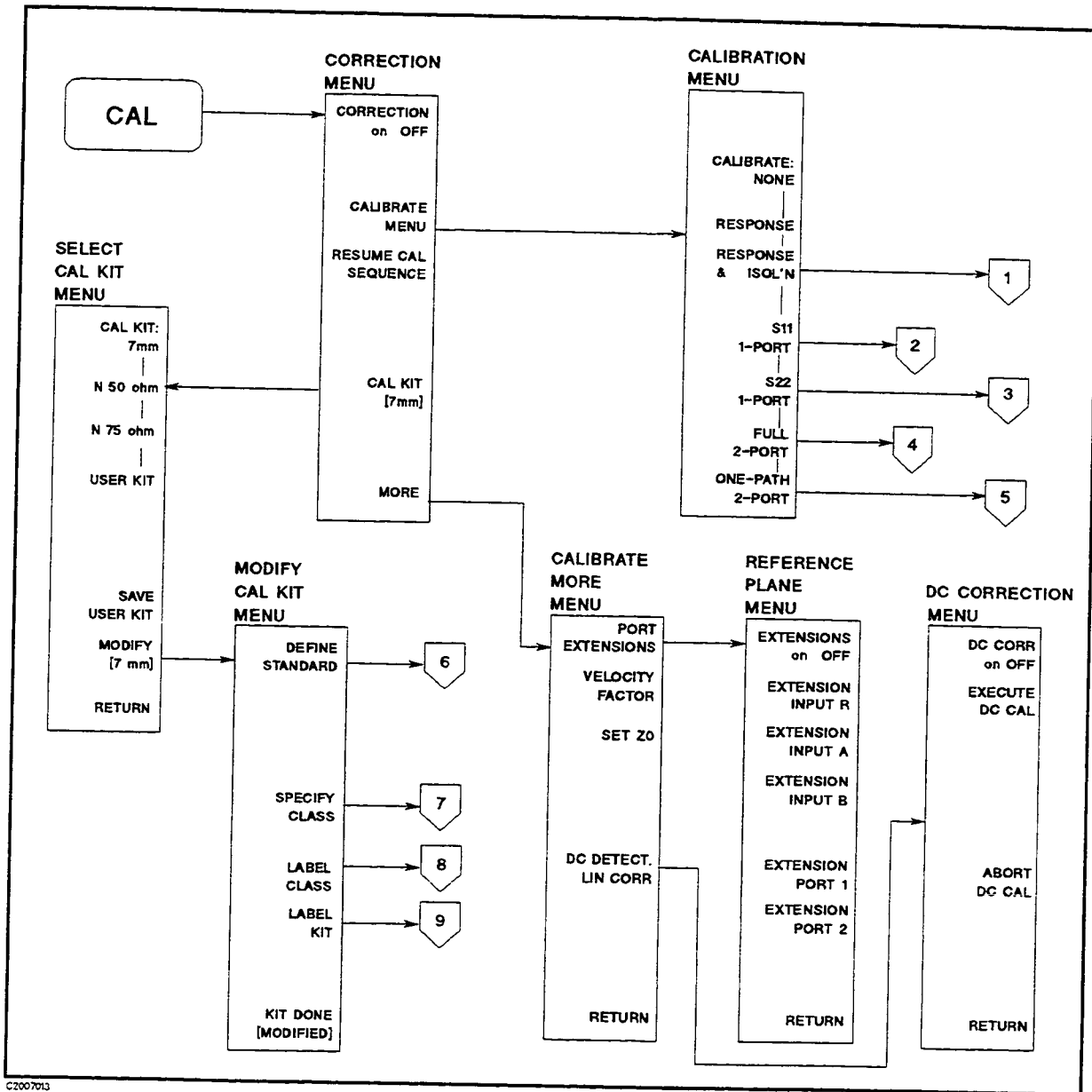

Figure 7-6. Softkey Menus Accessed from the **CAL** Key

The HP-IB programming command is shown in parenthesis following the key or softkey. The **CAL** (KEY 15) key leads to a series of menus that implement the accuracy enhancement procedures described in the preceding pages (see Figure 7-6). Accuracy enhancement (error correction) is performed as a calibration step before measurement of a test device. The analyzer uses one of several different procedures to measure the systematic (repeatable) errors of the system and remove their effects from the measured data. The calibration menus and procedures are described and illustrated in the following pages. Each procedure compensates for one or more of the systematic error terms. These range from a simple response calibration that removes the frequency response errors of the test setup to a full two-port vector

calibration that removes all twelve error terms. Measurements of standard devices solve for the error terms.

Standard Devices

The standard devices required for system calibration are available in compatible calibration kits with different connector types. The model numbers and contents of these calibration kits are listed in the General Information and Specifications section. Each kit contains at least one SHORT, one OPEN, and two impedance-matched LOADs. In kits that require adapters for interface to the test set ports, the adapters are phase-matched for calibration prior to measurement of non-insertable and non-reversible devices. Other standard devices can be used by specifying their characteristics in a user-defined kit, as described later in this chapter under "MODIFYING CALIBRATION KITS".

The accuracy improvement of the correction is limited by the quality of the standard devices, and by the connection techniques used. For information about connector care and connection techniques, refer to *Application Note 326 Principles of Microwave Connector Care*. When possible, use a torque wrench for final connections. The techniques for torquing connections and the part numbers for torque wrenches recommended for different connector types are provided in the connector care documents mentioned above.

Interpolated Error Correction

The interpolated error correction feature allows the operator to change sweep range, or sweep type, without recalibration. Interpolation is activated automatically when one or more of these stimulus parameters is changed as listed in the following table.

- Sweep range is changed to fall inside of the calibrated range.
- Sweep type is changed.
- Number of points is changed.

When interpolation is ON, the system errors for the newly selected frequencies are calculated from the system errors of the original calibration.

Note

There is no softkey to turn off interpolation.



Interpolated error correction functions in all sweep modes: linear frequency, log frequency, power sweep, and list sweep.

Channel Coupling

Up to four sets of measurement calibration data can be defined for each instrument state, one for each channel and each input port. (If two port full calibration is used, up to two sets of measurement calibration data can be defined, one for each channel.) If the two channels are stimulus coupled and the input ports are the same for both channels, they share the same calibration data. If the two channel inputs are different, they can have different calibration data. If the two channels are stimulus uncoupled, the measurement calibration applies to only one channel. For information on stimulus coupling, refer to Chapter 5.

CAL Key

Measurement Parameters

Calibration procedures are parameter-specific, rather than channel-specific. When a parameter is selected, the instrument checks the available calibration data, and uses the data found for that parameter. For example, if a transmission response calibration is performed for B/R, and an S_{11} 1-port calibration for A/R, the analyzer retains both calibration sets and corrects whichever parameter is displayed. Once a calibration has been performed for a specific parameter or input, measurements of that parameter remain calibrated in either channel (as long as the stimulus values are coupled). In the response and response and isolation calibrations, the parameter must be selected before calibration: other correction procedures select parameters automatically. Changing channels during a calibration procedure invalidates the part of the procedure already performed.

Device Measurements

In procedures that require measurement of several different devices, for example a SHORT, an OPEN, and a LOAD, the order in which the devices are measured is not critical. Any standard can be re-measured, until the **DONE** key is pressed. The change in trace during measurement of a standard is normal.

Response and response and isolation calibrations require measurement of only one standard device. If more than one device is measured, only the data for the last device is retained.

Omitting Isolation Calibration

Isolation calibration can be omitted for most measurements, except where wide dynamic range is a consideration. Use the following guidelines. When the measurement requires a dynamic range of:

- under 80 dB: Omit isolation calibration for most measurements.
- 80 to 100 dB: Isolation calibration is recommended with approximately 0 dBm into the R input.
- over 100 dB: Averaging should be ON with an averaging factor ≥ 16 , both for isolation calibration and for measurement after calibration.

Stopping During the Calibration Procedure

You can stop at any point during a calibration procedure, without losing the steps you have already performed. No special steps are necessary to leave; just do whatever task you want. To continue the calibration where you left off, press **CAL** **RESUME CAL SEQUENCE**.

Saving Calibration Data

It is recommended that calibration data be saved on a built-in disk. Refer to Chapter 11. If a calibration is not saved, it will be lost if another calibration procedure is selected for the same channel. Instrument preset, power on, and instrument state recall will also clear the calibration data.

Specifying Calibration Kits

In addition to the menus for the different calibration procedures, the **CAL** key provides access to a series of menus used to specify the characteristics of the calibration standards used. Hewlett-Packard calibration kits are predefined, or the definitions can be modified to any set of standards used.

Correction Menu

The correction menu is the first menu presented by the **CAL** key, and it provides access to numerous menus of additional calibration features.

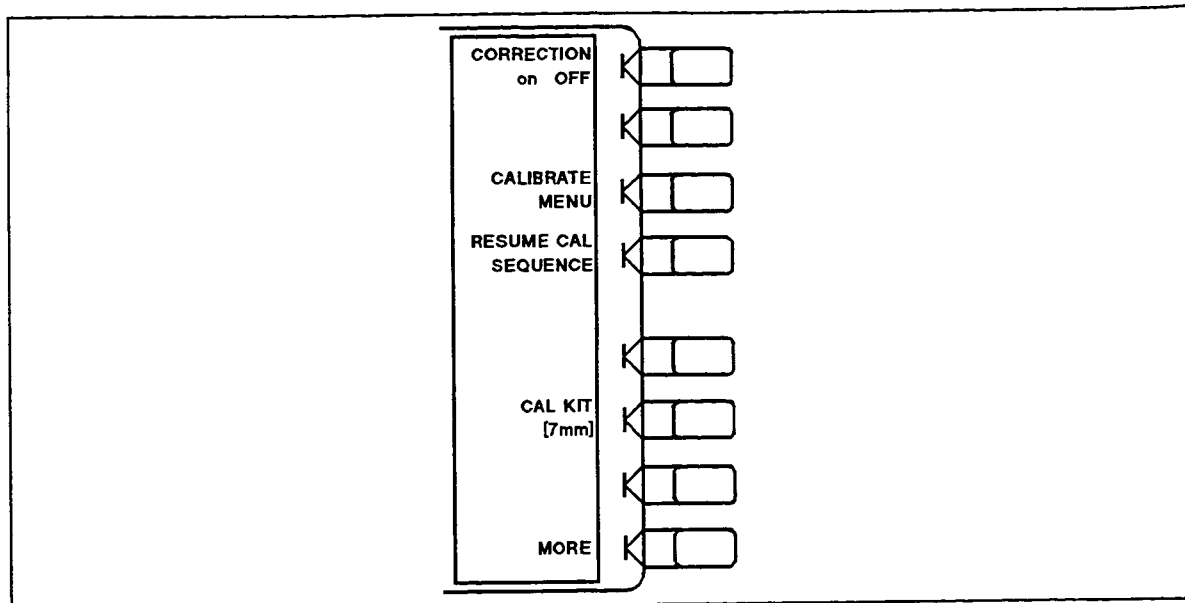

C2007001

Figure 7-7. Correction Menu

CORRECTION on OFF (CORRON, CORROFF) turns error correction ON or OFF. The analyzer uses the most recent calibration data for the displayed parameter.

If one of the next stimulus parameters has been changed, correction is automatically turned OFF.

- Input measurement port is changed.
- Calibration type is changed.

If one of the next stimulus parameters has been changed, interpolated correction is automatically turned on and the status notation is changed to "C?" or "C2?" (refer to "CRT DISPLAY" in Chapter 2).

- Sweep range is changed to fall inside of the calibrated range.
- Sweep type is changed.
- Number of Point is changed.

If one of the next stimulus parameters has been changed, the status notation is changed to "C!" or "C2!" (refer to "CRT DISPLAY" in Chapter 2). In this status, error corrections at a stimulus point will be done using calibration coefficient at the nearest calibrated frequency point, or the CW frequency.

- Sweep range is changed so both start and stop, or one of the start and stop stimulus value are/is out the calibrated range.
- Sweep type is changed to or from power sweep. (If span is zero and measurement frequency is equal to CW frequency of power sweep, the status is not changed.)

CAL Key

A calibration must be performed before correction can be turned ON. If no valid calibration exists, the message "CALIBRATION REQUIRED" is displayed on the display.

It is recommended that calibration data be saved on the built-in disk, using the capabilities described in Chapter 11.

CALIBRATE MENU leads to the calibration menu, which provides several accuracy enhancement procedures ranging from a simple frequency response calibration to a full two-port calibration. At the completion of a calibration procedure, correction is automatically turned ON, and the notation "Cor" or "C2" is displayed at the left of the screen.

RESUME CAL SEQUENCE (RESC) eliminates the need to restart a calibration sequence that was interrupted to access some other menu. This softkey goes back to the point where the calibration sequence was interrupted.

CAL KIT leads to the select cal kit menu, which selects one of the default calibration kits available for different connector types. This in turn leads to additional menus used to define calibration standards other than those in the default kits (refer to "MODIFYING CALIBRATION KITS", later in this chapter). When a calibration kit has been specified, its connector type is displayed in brackets in the softkey label.

MORE provides access to the calibrate more menu, which extends the test port reference plane, to specify the characteristic impedance of the system, the relative propagation velocity factor, and DC linearity correction.

Select Cal Kit Menu

This selects the calibration kit for a measurement calibration. Selecting a cal kit chooses the model that mathematically describes the standard devices actually used. Refer to the beginning of this chapter, and the appendix at the end of this chapter, for more background on measurement calibrations and error correction.

The analyzer has the capability to calibrate with three predefined cal kits in four different connector types. The models for these cal kits correspond to the standard calibration kits available as accessories:

7 mm	HP 85031B 7 mm calibration kit
50 Ω Type-N	HP 85032B 50 Ω type-N calibration kit
75 Ω Type-N	HP 85036B 75 Ω type-N calibration kit

Cal kits other than those listed can be used. For example: The errors introduced by using the internal 7 mm model with a Hewlett-Packard 7 mm cal kit other than the HP 85031B are very small. For the highest accuracy, the more closely the model matches the device, the better.

In addition to the three predefined cal kits, a fourth choice is a "user kit" that is defined or modified by the user. This is described under "MODIFYING CALIBRATION KITS" later in this chapter.

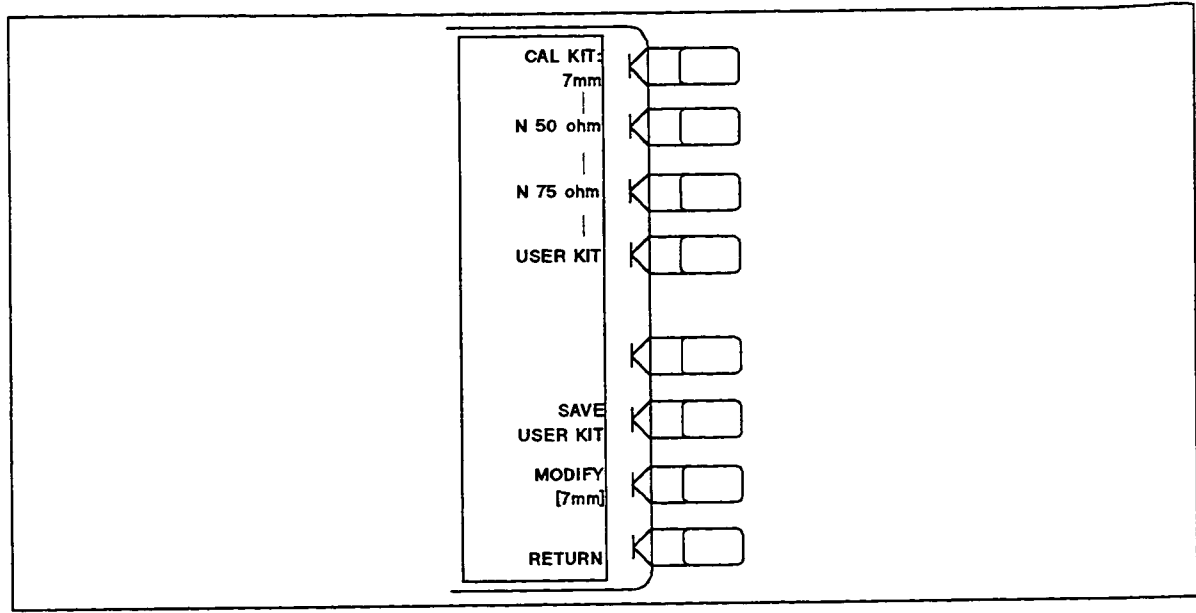

Figure 7-8. Select Cal Kit Menu

CAL KIT: 7mm (CALK7MM) selects the 7 mm cal kit model.

N 50Ω (CALKN50) selects the 50 Ω type-N model.

N 75Ω (CALKN75) selects the 75 Ω type-N model.

Note



If **N 50Ω** or **N 75Ω** is selected, additional menus are provided during calibration procedures to select the connector sex. This is the connector sex of the input port, not the actual calibration standard.

USER KIT (CALKUSED) selects a cal kit model defined or modified by the user. For information, refer to “MODIFYING CALIBRATION KITS”, later in this chapter.

SAVE USER KIT (SAVEUSEK) stores the user-modified or user-defined kit into memory, after it has been modified.

MODIFY (MODI1) leads to the modify cal kit menu, where a default cal kit can be user-modified.

RETURN returns to the correction menu.

Calibrate More Menu

This menu extends the test port reference plane, specifies the characteristic impedance of the system, and specifies the relative propagation velocity factor.

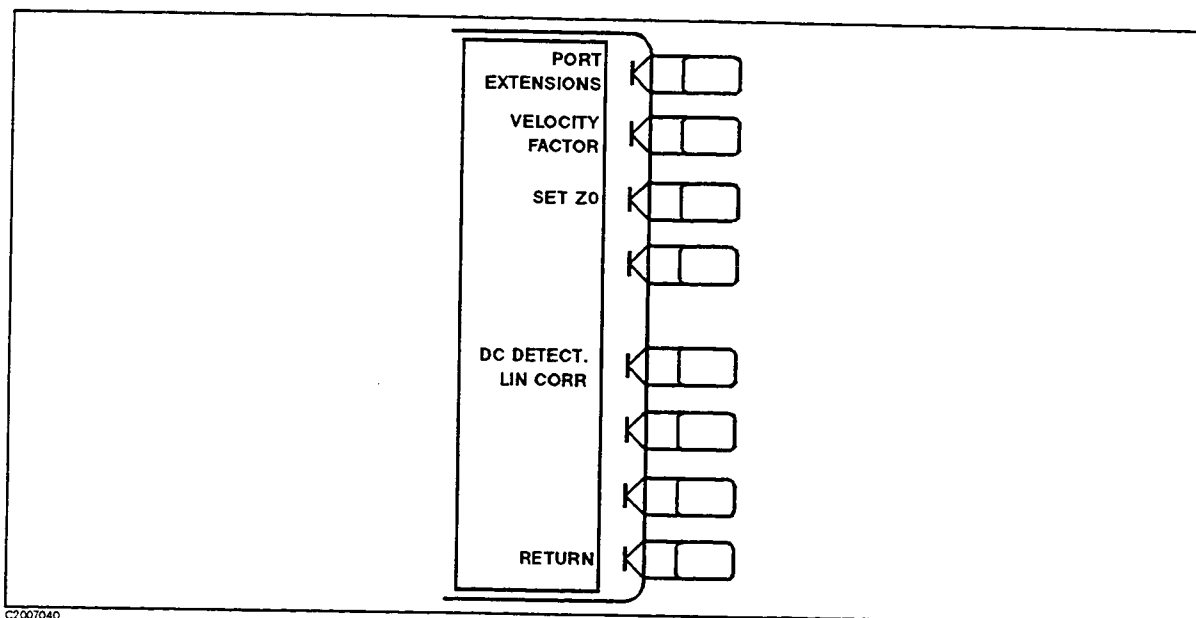

Figure 7-9. Calibrate More Menu

PORT EXTENSIONS goes to the reference plane menu, which extends the apparent location of the measurement reference plane or input.

The differences between the **PORT EXTENSIONS** and **ELECTRICAL DELAY** functions are described in the following table.

Table 7-1. Differences between PORT EXTENSIONS and ELECTRICAL DELAY

	PORT EXTENSIONS	ELECTRICAL DELAY
Main Effect	The end of a cable becomes the test port plane for all S-parameter measurements.	Compensates for the electrical length of a cable for the current type of measurement only. Reflection = 2 times cable's electrical length. Transmission = 1 times cable's electrical length.
Measurements Affected	All S-parameters.	Only the currently selected measurement parameter.
Electrical Compensation	Intelligently compensates for 1 times or 2 times the cable's electrical delay, depending on which S-parameter is computed.	Only compensates as necessary for the currently selected measurement parameter.

VELOCITY FACTOR (VELOFACT) enters the velocity factor used by the analyzer to calculate equivalent electrical length. Values entered should be less than 1. For example, the velocity factor of Teflon is:

$$V_f = \frac{1}{\sqrt{\epsilon_R}}$$

$$= 0.666$$

SET Z0 (SETZ) sets the characteristic impedance used by the analyzer in calculating measured impedance with Smith chart markers and conversion parameters. If the test set used is an HP 87511B S-parameter test set or an HP 87512B Transmission/Reflection Test Kit, set Z₀ to 75 Ω. Characteristic impedance must be set correctly before calibration procedures are performed.

DC DETECT LIN CORR provides the DC correction menu, which calibrates an external DC voltage detector in the Bdc or Bdc/R measurements.

RETURN goes back to the correction menu.

Reference Plane Menu

This adds electrical delay in seconds to the measurement ports to extend the apparent location of the measurement reference plane to the ends of the cables. This is equivalent to adding a length of perfect air line, and makes it possible to measure the delay response of the DUT only, instead of the DUT plus the adapter, cable, or other incidental device. Read the previous description of Port Extension for more information.

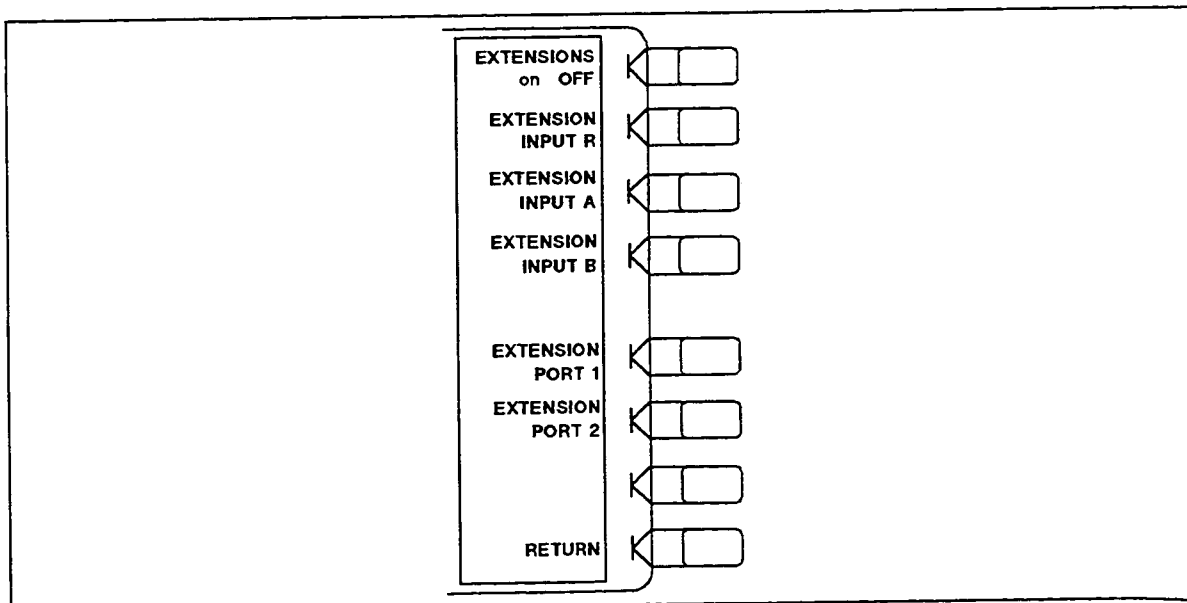

C2007041

Figure 7-10. Reference Plane Menu

EXTENSIONS on OFF (POREON, POREOFF) toggles the reference plane extension mode. When this function is ON, all extensions defined below are enabled; when OFF, none of the extensions are enabled.

CAL Key

EXTENSION INPUT R (PORTR) adds electrical delay in seconds to extend the reference plane at input R to the end of the cable. This is used for any R input measurements including S-parameters.

EXTENSION INPUT A (PORTA) adds electrical delay to the input A reference plan for any A input measurements including S-parameters.

EXTENSION INPUT B (PORTB) adds electrical delay to the input B reference plane for any B input measurements including S-parameters.

EXTENSION PORT 1 (PORT1) extends the reference plane for measurements of S_{11} , S_{21} , and S_{12} .

EXTENSION PORT 2 (PORT2) extends the reference plane for measurements of S_{22} , S_{12} , and S_{21} .

RETURN goes back to the calibrate more menu.

DC Correction Menu

This calibrates an external DC detector's output voltage linearity for the Bdc or Bdc/R measurements. When the calibration starts, the analyzer sweeps its output power from -50 dBm to +15 dBm to obtain the detector's response. After the sweep ends, the calibration data for the detector's non-linearity is calculated and stored to non volatile memory.

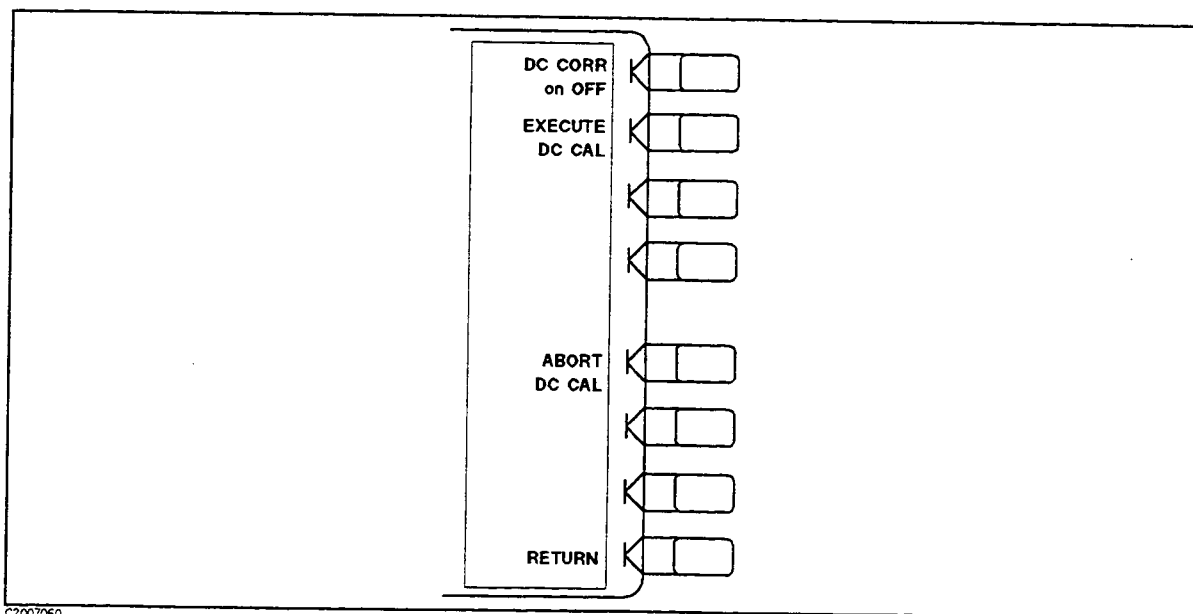

Figure 7-11. DC Correction Menu

DC CORR on OFF (DCCORON, DCCOROFF) turns error correction ON or OFF. The analyzer uses the most recent calibration data.

EXECUTE DC CAL (EXEDCALI) starts calibration. The calibration is performed by sweeping the output power from -50 dBm to +15 dBm. The swept signal's frequency is set by the **CW FREQ** described in "Stimulus Menu" in Chapter 5.

Note Any frequency response of the detector can be calibrated.



Caution Make sure the detector is capable of +15 dBm input at the calibrating frequency.



After the calibration is done, the calibration data is calculated and stored. The sweep parameter will be the power sweep, regardless of the prior sweep parameter.

ABORT DC CAL (ABODCALI) aborts the calibration.

RETURN returns to the Calibrate More Menu.

Calibration Menu

This selects the type of measurement calibration you wish to perform. Six different calibration routines are available, each of which effectively removes from one to twelve systematic errors from the measurement data. Each calibration procedure features display prompts to guide you through the calibration sequence. The available calibrations are described below, and a comparative summary is provided in Table 7-2. Procedures for performing each of the calibrations are provided in the following pages, together with illustrations of the corresponding menus.

Note that all instrument parameters should be established before a calibration procedure is started, including stimulus values, calibration kit, and system characteristic impedance Z_0 (To modify the characteristic impedance, refer to “Calibrate More Menu”). You may choose a subset of the full frequency range, or a different sweep type, using the interpolated error correction, after the system has been calibrated. (Refer to “Interpolated Error Correction” and “Correction Menu” in this Chapter.) The performance of interpolated error correction is not specified.

Note By convention, when the connector sex is provided in parentheses for a calibration standard, it refers to the sex of the test port connector, not the sex of the standard. For example, “SHORT [m]” indicates that the test port connector is male, not the SHORT connector.



Note The compatible type-N calibration kits for the analyzer provide OPENs with center conductor extenders. For maximum accuracy in calibration with these devices, follow these steps:



1. Connect the outer conductor by hand and tighten with a torque wrench.
2. Insert the center conductor extender into the outer conductor. The fit should be snug but free.
3. Push gently until the center conductors mate.

For measurement of test devices following calibration, refer to *the User's Guide*.

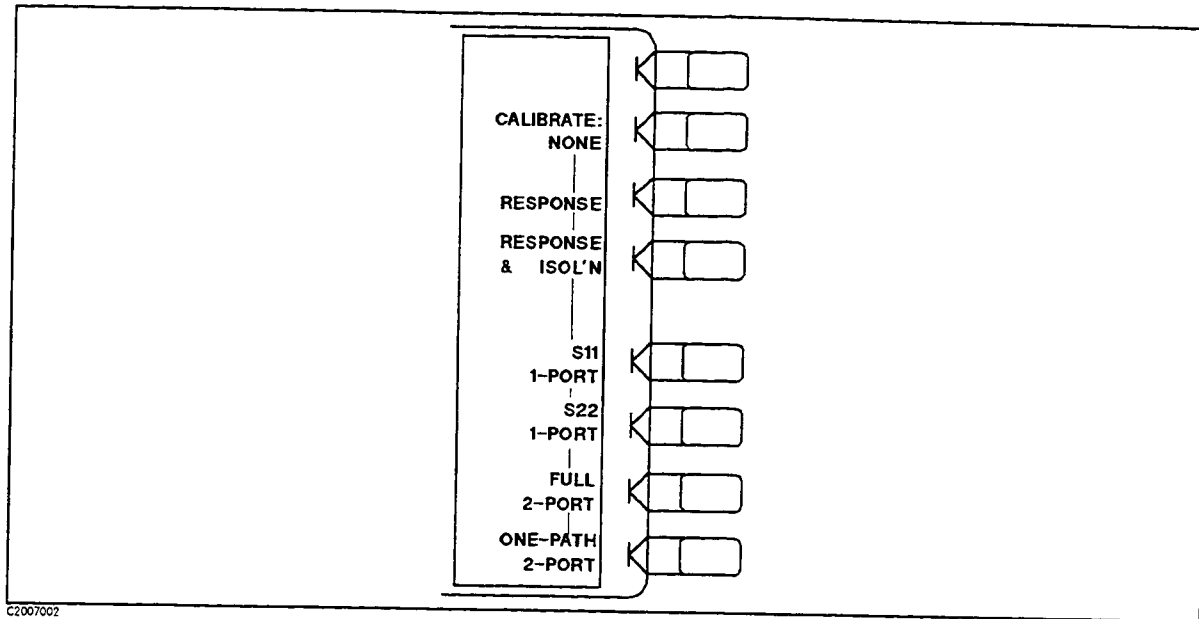

Figure 7-12. Calibration Menu

CALIBRATE: NONE (CALN) is underlined if no calibration has been performed or if the calibration data has been cleared. Unless a calibration is saved on the internal disk, the calibration data is lost on instrument preset, power ON, or instrument state recall.

RESPONSE (CALIRESP) leads to the frequency response calibration. This is the simplest and fastest accuracy enhancement procedure, but should be used when extreme accuracy is not required. It effectively removes the frequency response errors of the test setup for reflection or transmission measurements.

For transmission-only measurements or reflection-only measurements, only a single calibration standard is required with this procedure. The standard for transmission measurements is a THRU, and for reflection measurements can be either an OPEN or a SHORT. If more than one device is measured, only the data for the last device is retained. The procedures for response calibration for a reflection measurement and a transmission measurement are described in the following pages.

RESPONSE & ISOL'N (CALIRAI) leads to the menus used to perform a response and isolation measurement calibration, for measurement of devices with wide dynamic range. This procedure effectively reduces the same errors as the response calibration. In addition, it effectively reduces the isolation (crosstalk) error in transmission measurements or the directivity error in reflection measurements. As well as the devices required for a simple response calibration, an isolation standard is required. The standard normally used to correct for isolation is an impedance-matched LOAD (usually 50 or 75 Ω). Response and directivity calibration procedures for reflection and transmission measurements are provided in the following pages.

S11 1-PORT (CALIS111) provides a measurement calibration for reflection-only measurements of one-port devices or properly terminated two-port devices, at port 1 of an S-parameter test set or the test port of a transmission/reflection test kit. This procedure effectively reduces the directivity, source match, and frequency response errors of the test setup, and provides a higher level of measurement accuracy than the response and isolation calibration. It is the

most accurate calibration procedure for reflection-only measurements. Three standard devices are required: a SHORT, an OPEN, and an impedance-matched LOAD. The procedure for performing an S_{11} one-port calibration is described in the following pages.

S22 1-PORT (CALIS221) is similar to **S11 1-PORT**. It is used for reflection-only measurements of one-port devices or properly terminated two-port devices in the reverse direction: that is, for devices connected to port 2 of the S-parameter test set.

FULL 2-PORT (CALIFUL2) leads to the series of menus used to perform a complete calibration for measurement of all four S-parameters of a two-port device. This is the most accurate calibration for measurements of two-port devices. It effectively reduces all correctable systematic errors (directivity, source match, load match, isolation, reflection tracking, and transmission tracking) in both the forward and the reverse direction. Isolation correction can be omitted for measurements of devices with limited dynamic range.

The standards for this procedure are a SHORT, an OPEN, a THRU, and an impedance-matched LOAD (two LOADs if isolation correction is required). An S-parameter test set is required. The procedure is described in the following pages.

ONE-PATH 2-PORT (CALIONE2) leads to the series of menus used to perform a high-accuracy two-port calibration without an S-parameter test set. This calibration procedure effectively reduces directivity, source match, load match, isolation, reflection tracking, and transmission tracking errors in one direction only. Isolation correction can be omitted for measurements of devices with limited dynamic range. (The device under test must be manually reversed between sweeps to accomplish measurement of both input and output responses.) The required standards are a SHORT, an OPEN, a THRU, and an impedance-matched LOAD. The procedure for performing a one-path 2-port calibration is described in the following pages.

Table 7-2. Purpose and Use of Different Calibration Procedures

Calibration Procedure	Corresponding Measurement	Errors Reduced	Standard Devices
Response	Transmission or reflection measurement when the highest accuracy is not required.	Freq. response	THRU for trans., OPEN or SHORT for reflection
Response & isolation	Transmission of high insertion loss devices or reflection of high return loss devices. Not as accurate as 1-port or 2-port calibration.	Freq. response plus isolation in transmission or directivity in reflection	Same as response plus isolation std (LOAD)
S_{11} 1-port	Reflection of any one-port device or well terminated two-port device.	Directivity, source match, freq. response.	SHORT and OPEN and LOAD
S_{22} 1-port	Reflection of any one-port device or well terminated two-port device.	Directivity, source match, freq. response.	SHORT and OPEN and LOAD
Full 2-port	Transmission or reflection of highest accuracy for two-port devices. HP 87511A, B S-parameter Test Set is required.	Directivity, source match, load match, isolation, freq. response, forward and reverse.	SHORT and OPEN and LOAD and THRU (2 LOADs for isolation)
One-path 2-port	Transmission or reflection of highest accuracy for two-port devices. (Reverse test device between forward and reverse measurements.)	Directivity, source match, load match, isolation, freq. response, forward direction only.	SHORT and OPEN and LOAD and THRU

Response Calibration for Reflection Measurements

This performs a frequency response only calibration with an S-parameter test set for a measurement of S_{11} . (Refer to Figure 7-13.) It can also be used for S_{22} by substituting the corresponding softkey in the S-parameters menu.

A similar procedure can be performed with a transmission/reflection test kit, using the input ports menu instead of the S-parameters menu (described in Chapter 6).

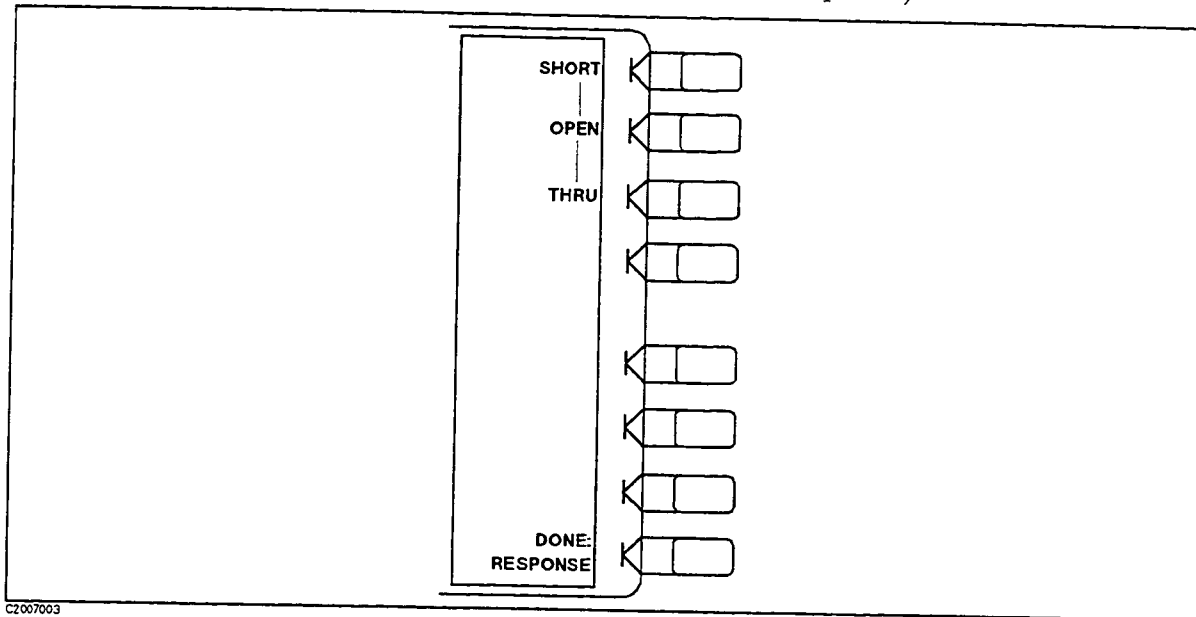

Figure 7-13. Response Cal Menu

Procedure

1. Press **MEAS** Refl: FWD S11 A/R.
2. Press **CAL**.
3. Select the proper calibration kit. If the connector type or cal kit name shown in the **CAL KIT** softkey label is not the same as the calibration kit to be used, refer to "Select Cal Kit Menu".
4. Press **CALIBRATE MENU RESPONSE**.
5. At port 1, connect either a **SHORT** or a shielded **OPEN**.
6. When the trace settles, press **SHORT** or **OPEN**, depending on the standard used. If more than one device is measured, only the data for the last device is retained.
7. The message "WAIT - MEASURING CAL STANDARD" is displayed while the data is measured. The softkey label **SHORT** or **OPEN** is then underlined.
8. Press **DONE: RESPONSE** to complete the calibration. The error coefficients are computed and stored. The correction menu is displayed with **CORRECTION ON**. A corrected trace is displayed.

Now the test device can be connected and measured. It is recommended that calibration data be saved using the built-in disk drive. Refer to Chapter 11.

Response Calibration for Transmission Measurements

This performs a frequency response only calibration with an S-parameter test set for a measurement of S_{21} . (Refer to Figure 7-13.) To calibrate for a combined transmission and reflection measurement, perform the transmission calibration on one channel and the reflection calibration described above on the other channel.

A similar procedure can be performed with a transmission/reflection test kit, using the input ports menu instead of the S-parameters menu (see Chapter 6).

Procedure

1. Press **MEAS** **Trans: FWD S21 B/R**.
2. Press **CAL**.
3. Select the proper calibration kit. If the connector type or cal kit name shown in the **CAL KIT** softkey label is not the same as the calibration kit to be used, refer to "Select Cal Kit Menu".
4. Press **CALIBRATE MENU RESPONSE**.
5. Connect a THRU (connect together the points at which the test device will be connected).
6. When the trace settles, press **THRU**.
7. The message "WAIT - MEASURING CAL STANDARD" is displayed while the S_{21} data is measured. The softkey label **THRU** is then underlined.
8. Press **DONE: RESPONSE** to complete the calibration. The error coefficients are computed and stored. The correction menu is displayed with **CORRECTION ON**. Corrected S_{21} data is displayed.

Now the test device can be connected and measured. It is recommended that calibration data be saved using the built-in disk drive. Refer to Chapter 11.

Response and Isolation Calibration for Reflection Measurements

This effectively reduces the frequency response and directivity errors for reflection measurements. The menus illustrated in Figure 7-14 perform a calibration with an S-parameter test set for a measurement of S_{11} . It can also be used for S_{22} by substituting the corresponding softkey in the S-parameters menu.

A similar procedure can be performed with a transmission/reflection test kit, using the input ports menu instead of the S-parameters menu (described in Chapter 6).

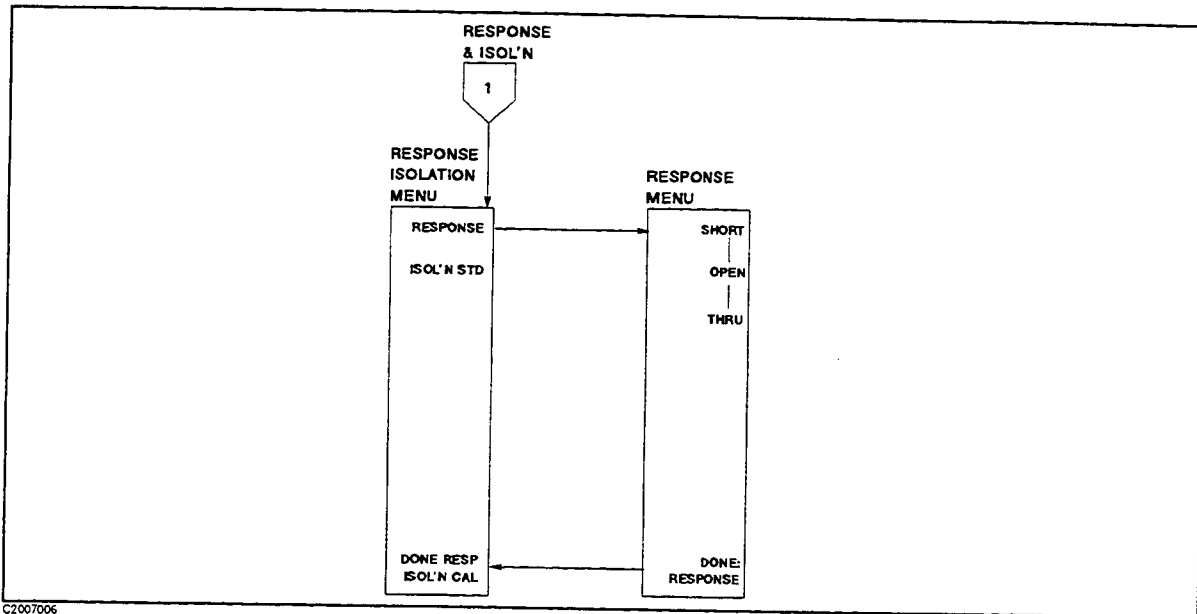

Figure 7-14. Response and Isolation Cal Menu and Response Cal Menu

Procedure

1. Press **MEAS** Refl: FWD S11 A/R.
2. Press **CAL**.
3. Select the proper calibration kit. If the connector type or cal kit name shown in the **CAL KIT** softkey label is not the same as the calibration kit to be used, refer to "Select Cal Kit Menu".
4. Press **CALIBRATE MENU** **RESPONSE & ISOL'N** **RESPONSE**.
5. At port 1, connect either a SHORT or a shielded OPEN.
6. When the trace settles, press **SHORT** or **OPEN**, depending on the standard used. If more than one standard is measured, only the data for the last device is retained.
7. The message "WAIT - MEASURING CAL STANDARD" is displayed while the response data is measured. The softkey label **SHORT** or **OPEN** is then underlined.
8. Press **DONE: RESPONSE**. The error coefficients are computed and stored. The response and isolation menu is displayed.
9. Connect the isolation standard to port 1. This is an impedance-matched LOAD (usually 50 or 75 Ω).

CAL Key

10. Press ISOL'N STD. The S_{11} isolation data is measured. The softkey label is underlined.
11. Press DONE RESP ISOL'N CAL to complete the calibration. The directivity error coefficients are computed and stored. The correction menu is displayed with CORRECTION ON. A corrected trace is displayed.

Now the test device can be connected and measured. It is recommended that calibration data be saved on a built-in disk. Refer to Chapter 11.

Response and Isolation Calibration for Transmission Measurements

This effectively reduces the frequency response and isolation errors for transmission measurements of devices with wide dynamic range, using the menus illustrated in Figure 7-14. To calibrate for a combined transmission and reflection measurement, perform the transmission calibration on one channel and the reflection calibration described above on the other channel.

This procedure uses an S-parameter test set. A similar procedure can be performed with a transmission/reflection test kit, using the input ports menu instead of the S-parameters menu (see Chapter 6).

Procedure

1. Press **MEAS** **Trans: FWD S21 B/R**.
2. Press **CAL**.
3. Select the proper calibration kit. If the connector type or cal kit name shown in the **CAL KIT** softkey label is not the same as the calibration kit to be used, refer to "Select Cal Kit Menu".
4. Press **CALIBRATE MENU RESPONSE & ISOL'N RESPONSE**.
5. Connect a THRU between port 1 and port 2 at the points where the test device will be connected.
6. When the trace has settled, press **THRU**. S_{21} response data is measured. The softkey label **THRU** is underlined.
7. Press **DONE: RESPONSE**.
8. Connect impedance-matched LOADs to port 1 and port 2. Press **ISOL'N STD**. The S_{21} isolation data is measured. The softkey label is underlined.
9. Press **DONE RESP ISOL'N CAL** to complete the calibration. The S_{21} error coefficients are computed and stored. The correction menu is displayed with **CORRECTION ON**. Corrected S_{21} data is displayed and the notation "Cor" at the left of the screen indicates that correction is ON for this channel.

A similar procedure calibrates for measurement of S_{12} , using the **Trans: REV S12 B/R** softkey in the S-parameters menu.

It is recommended that calibration data be saved on a built-in disk. Refer to Chapter 11.

S₁₁ 1-Port Calibration for Reflection Measurements

This performs a complete vector error correction for reflection measurements of one-port devices or properly terminated two-port devices. (Refer to Figure 7-15.) This is a high-accuracy calibration that effectively reduces the directivity, source match, and frequency response errors from the measured data. The calibration described here uses an S-parameter test set: a similar procedure can be performed with a transmission/reflection test kit, using the input ports menu instead of the S-parameters menu described in Chapter 6.

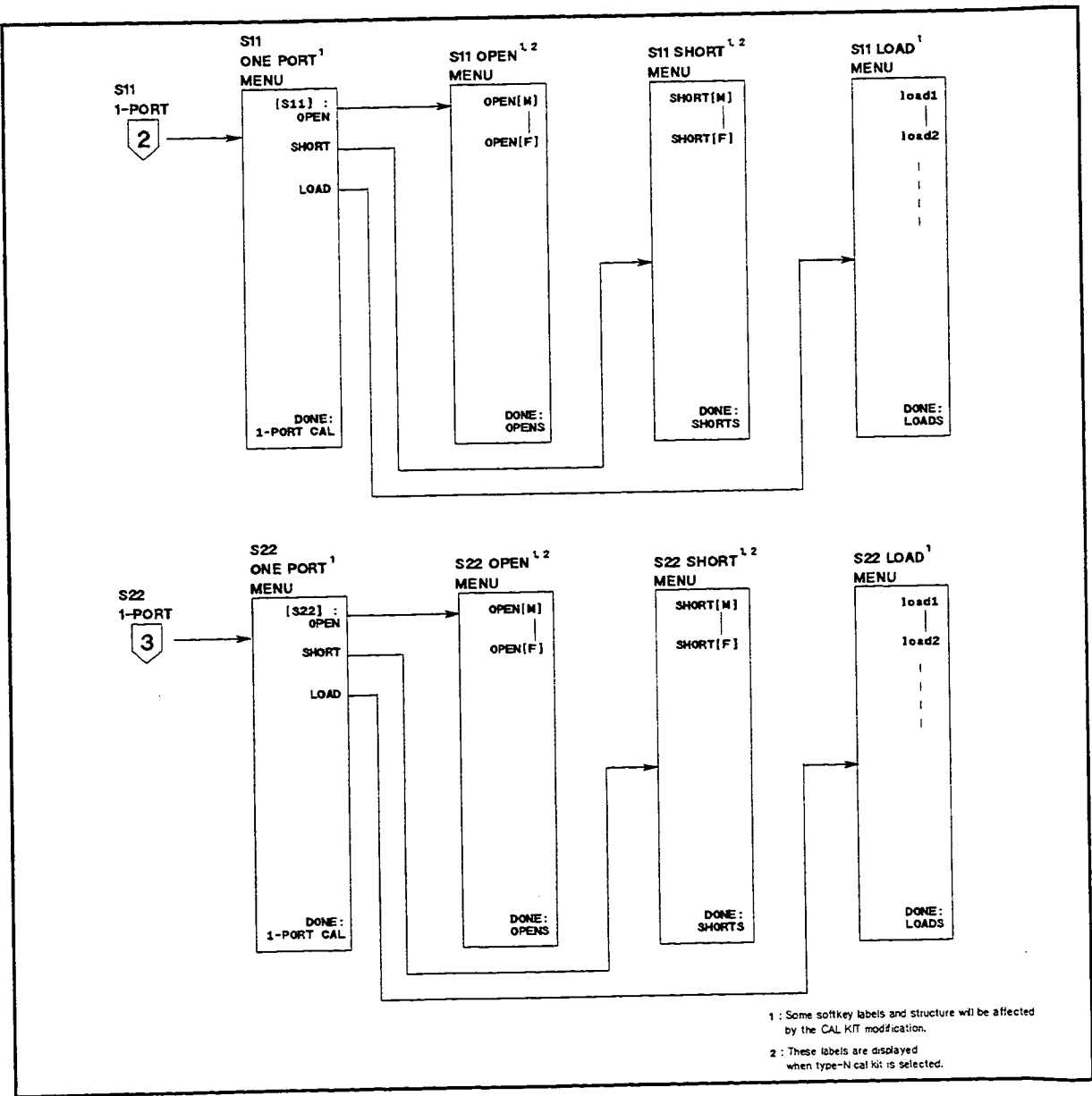

C2007007

Figure 7-15. S₁₁ and S₂₂ 1-Port Cal Menus

CAL Key

Procedure

1. Press **CAL**.
2. Select the proper calibration kit. If the connector type or cal kit name shown in the **CAL KIT** softkey label is not the same as the calibration kit to be used, refer to "Select Cal Kit Menu".
3. Press **CALIBRATE MENU S11 1-PORT**.
4. Connect a shielded OPEN to port 1.
5. When the trace settles, press **(S11):OPEN** (for the 7 mm cal kit) or **(S11):OPENS** (for the type-N cal kit).
6. When the 7 mm cal kit is selected in step 2, the message "WAIT - MEASURING CAL STANDARD" is displayed while the OPEN data is measured. The softkey label **OPEN** is then underlined.

When the type-N cal kit is selected in step 2, the **OPEN [M]** and **OPEN [F]** softkeys are displayed. Press **OPEN [M]** (for male port connector) or press **OPEN [F]** (for female port connector). The message "WAIT - MEASURING CAL STANDARD" is displayed while the OPEN data is measured. The softkey label is then underlined.
7. Disconnect the OPEN, and connect a SHORT to port 1.
8. When the trace settles, press **SHORT** (for the 7 mm cal kit) or **SHORTS** (for the type-N cal kit).
9. When the 7 mm cal kit is selected in step 2, the SHORT data is measured and the softkey label is underlined.

When the type-N cal kit is selected in step 2, the **SHORT [M]** and **SHORT [F]** softkeys are displayed. Press **SHORT [M]** (for male port connector) or press **SHORT [F]** (for female port connector). The SHORT data is measured and the softkey label is then underlined.
10. Disconnect the SHORT, and connect an impedance-matched LOAD (usually 50 or 75 Ω) at port 1.
11. When the trace settles, press **LOAD**. The LOAD data is measured and the softkey label is underlined.
12. Press **DONE 1-PORT CAL** to complete the calibration. (If you press **DONE** without measuring all the required standards, the message "CAUTION: ADDITIONAL STANDARDS NEEDED" will be displayed.) The error coefficients are computed, and the correction menu is returned to the screen with **CORRECTION ON**. A corrected S₁₁ trace is displayed, and the notation "Cor" appears at the left side of the screen.

The test device can now be connected and measured. It is recommended that calibration data be saved on a built-in disk. Refer to Chapter 11.

S₂₂ 1-Port Calibration

This performs a complete vector error correction for a reverse reflection measurement of a one-port device or a properly terminated two-port device. It is similar to the S₁₁ 1-port calibration except that S₂₂ is selected automatically.

This calibration is used only with an S-parameter test set. For S-parameter measurements in the reverse direction with a transmission/reflection test kit use the S₁₁ 1-port or one-path 2-port calibration and reverse the device under test between measurement sweeps.

Full 2-Port Calibration for Reflection and Transmission Measurements

This performs complete vector error correction for measurement of all four S-parameters. (Refer to Figure 7-16.) This is the most accurate calibration for measurements of two-port devices, and effectively reduces all correctable systematic errors in both the forward and reverse directions.

An S-parameter test set is required for this calibration. The procedure automatically switches the test set to select the appropriate S-parameter at each step. A similar two-port procedure can be performed with a transmission/reflection test kit using the one-path 2-port calibration.

To extend the life of the mechanical transfer switch in the HP 87511A, B S-parameter Test Sets, switching occurs only once in a measurement sequence using full two-port error correction. On the first sweep all four S-parameters are measured. On subsequent sweeps, the assumption is made that the reverse parameters have not changed, and only the forward parameters are measured. It is possible to override this protection feature for applications where extreme accuracy is required or in cases where the data changes significantly. To perform an override, use **MEASURE RESTART** in the stimulus menu, or for repeated update of all four S-parameters set an appropriate number of groups using the **NUMBER of GROUPS** softkey. These menus are described in Chapter 5.

Isolation calibration can be omitted for most measurements, except where wide dynamic range is a consideration. Refer to the explanation under "**CAL** Key".

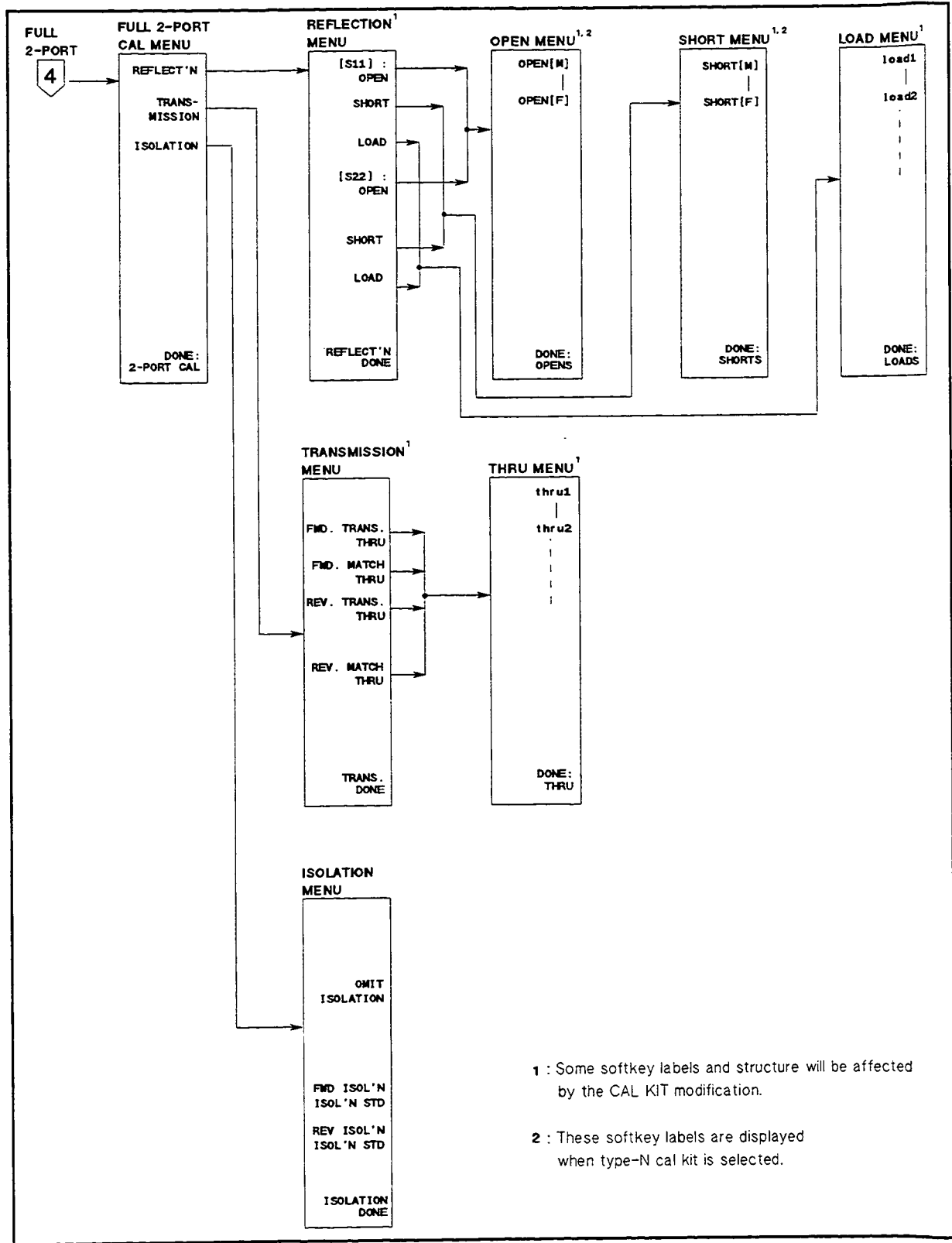

C2007008

Figure 7-16. Full 2-Port Cal Menu

CAL Key

Procedure for Full 2-Port Calibration

1. Press **CAL**.
2. Select the proper calibration kit. If the connector type or cal kit name shown in the **CAL KIT** softkey label is not the same as the calibration kit to be used, refer to "Select Cal Kit Menu".
3. Press **CALIBRATE MENU FULL 2-PORT REFLECT'N**.
4. Connect a shielded OPEN to port 1.
5. When the trace settles, press **(S₁₁): OPEN** (for the 7 mm cal kit) or **(S₁₁): OPENS** (for the type-N cal kit).
6. When the 7 mm cal kit is selected in step 2, the OPEN data is measured, and the softkey label **OPEN** is underlined.

When the type-N cal kit is selected in step 2, the **OPEN [M]** and **OPEN [F]** softkeys are displayed. Press **OPEN [M]** (for male port connector) or press **OPEN [F]** (for female port connector). The OPEN data is measured. The softkey label is then underlined.
7. Disconnect the OPEN, and connect a SHORT to port 1.
8. When the trace settles, press **(S₁₁): SHORT** (for the 7 mm cal kit) or **(S₁₁): SHORT** (for the type-N cal kit).
9. When 7 mm cal kit is selected in step 2, the SHORT data is measured and the softkey label **SHORT** is underlined.

When the type-N cal kit is selected in step 2, the **SHORT [M]** and **SHORT [F]** softkeys are displayed. Press **SHORT [M]** (for male port connector) or press **SHORT [F]** (for female port connector). The SHORT data is measured and the softkey label is then underlined.
10. Disconnect the SHORT, and connect an impedance-matched LOAD (usually 50 or 75 Ω) at port 1.
11. When the trace settles, press **(S₁₁): LOAD**. The LOAD data is measured, and the softkey label **LOAD** is underlined.
12. Repeat the OPEN-SHORT-LOAD measurements described above, connecting the devices in turn to port 2 and using the **(S₂₂)** softkeys.
13. Press **REFLECT'N DONE**. (If you press **DONE** without measuring all the required standards, the message "CAUTION: ADDITIONAL STANDARDS NEEDED" will be displayed.)
14. The reflection calibration coefficients are computed and stored. The two-port cal menu is displayed, with the **REFLECT'N** softkey underlined.
15. Press **TRANSMISSION**.
16. Connect a THRU connection between port 1 and port 2 at the points where the test device will be connected.
17. When the trace settles, press **FWD. TRANS. THRU**. S₂₁ frequency response is measured, and the softkey is underlined.
18. Press **FWD. MATCH THRU**. S₁₁ load match is measured, and the softkey is underlined.

CAL Key

19. Press **REV** **TRANS** **THRU**. S_{12} frequency response is measured, and the softkey is underlined.
20. Press **REV** **MATCH THRU**. S_{22} load match is measured, and the softkey is underlined.
21. Press **TRANS** **DONE**. The transmission coefficients are computed and stored. The two-port cal menu is displayed, with the **TRANSMISSION** softkey underlined.
22. If correction for isolation is not required, press **ISOLATION OMIT ISOLATION** **ISOLATION DONE**.
23. If correction for isolation is required, connect impedance-matched LOADs to port 1 and port 2.
24. Press **FWD ISOL'N ISOL'N STD**. S_{21} isolation is measured, and the softkey label is underlined.
25. Press **REV ISOL'N ISOL'N STD**. S_{12} isolation is measured, and the softkey label is underlined.
26. Press **ISOLATION DONE**. The isolation error coefficients are stored. The two-port cal menu is displayed, with the **ISOLATION** softkey underlined.
27. Press **DONE 2-PORT CAL** to complete the calibration. The error coefficients are computed and stored. The correction menu is displayed with **CORRECTION ON**. A corrected trace is displayed, and the notation "C2" at the left of the screen indicates that two-port error correction is ON.

Now the test device can be connected and measured. It is recommended that the calibration data be saved using the built-in disk drive. Refer to Chapter 11.

CAL Key

One-Path 2-Port Calibration for Reflection and Transmission Measurements

This performs a two-port calibration without an S-parameter test set, using the series of menus illustrated in Figure 7-17. This is a highly accurate calibration for measurements of two-port devices, and effectively reduces all correctable systematic errors in one direction only.

Isolation calibration can be omitted for most measurements, except where wide dynamic range is a consideration. Refer to the explanation under “**CAL Key**”.

For measurements of all four S-parameters, the device under test must be reversed between sweeps. The analyzer compatible calibration kits contain sets of phase-matched adapters that can be interchanged for measurements of non-insertable, non-reversible devices.

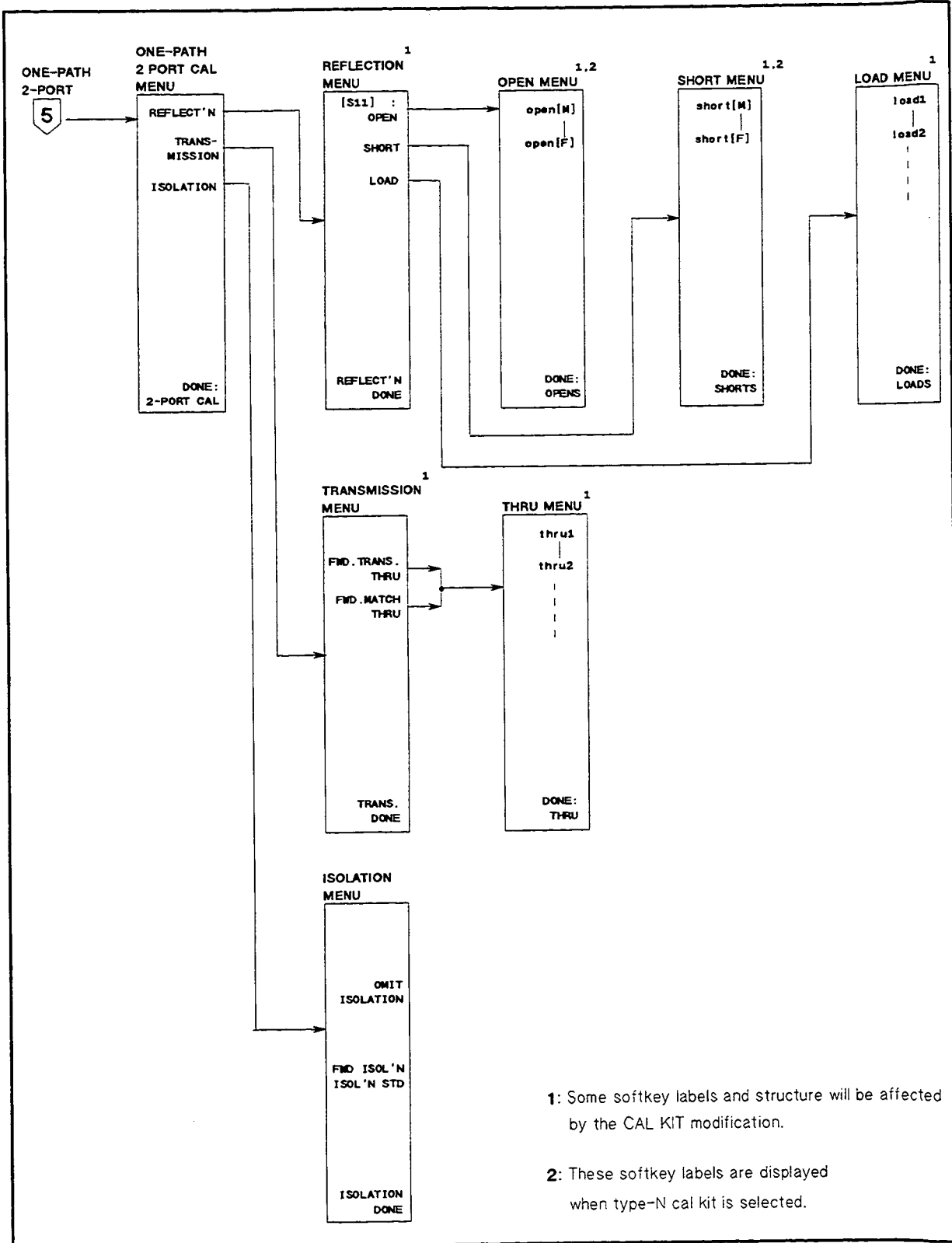

C2007009

Figure 7-17. One-Path 2-Port Cal Menu

CAL Key

One-Path 2-Port Calibration for Reflection and Transmission Measurements

1. Press **CAL**.
2. Select the proper calibration kit. If the connector type or cal kit name shown in the **CAL KIT** softkey label is not the same as the calibration kit to be used, refer to "Select Cal Kit Menu".
3. Press **CALIBRATE MENU ONE-PATH 2-PORT REFLECT'N**.
4. Connect a shielded OPEN to the test port.
5. When the trace settles, press **(S₁₁): OPEN** (for the 7 m cal kit) or **(S₁₁): OPENS** (for the type-N cal kit). The OPEN data is measured, and the softkey label **OPEN** is underlined.

When the type-N cal kit is selected in step 2, the **OPEN [M]** and **OPEN [F]** softkeys are displayed. Press **OPEN [M]** (for male port connector) or press **OPEN [F]** (for female port connector). The OPEN data is measured. The softkey label is then underlined.
6. Disconnect the OPEN, and connect a SHORT to the test port.
7. When the trace settles, press **SHORT** (for the 7 mm cal kit) or **SHORTS** (for the type-N cal kit).
8. When the 7 mm cal kit is selected in step 2, the SHORT data is measured and the softkey label **SHORT** is underlined.

When the type-N cal kit is selected in step 2, the **SHORT [M]** and **SHORT [F]** softkeys are displayed. Press **SHORT [M]** (for male port connector) or press **SHORT [F]** (for female port connector). The SHORT data is measured and the softkey label is then underlined.
9. Disconnect the SHORT, and connect an impedance-matched LOAD (50 or 75 Ω) to the test port.
10. When the trace settles, press **LOAD**. The LOAD data is measured, and the softkey label **LOAD** is underlined.
11. Press **REFLECT'N DONE**. (If you press **DONE** without measuring all the required standards, the message "CAUTION: ADDITIONAL STANDARDS NEEDED" will be displayed.)
12. The reflection calibration coefficients are computed and stored. The two-port cal menu is displayed, with the **REFLECT'N** softkey underlined.
13. Connect a THRU between the test port and the return cable to the analyzer (connect the points at which the test device will be connected). Press **TRANSMISSION**.
14. When the trace settles, press **FWD. TRANS. THRU**. S₂₁ frequency response is measured, and the softkey is underlined.
15. Press **FWD. MATCH THRU**. S₁₁ load match is measured, and the softkey is underlined.
16. Press **TRANS. DONE**. The transmission coefficients are computed and stored. The two-port cal menu is displayed, with the **TRANSMISSION** softkey underlined.
17. If correction for isolation is not required, press **ISOLATION OMIT ISOLATION ISOLATION DONE**.

CAL Key

18. If correction for isolation is required, connect impedance-matched LOADs to the test port (of Transmission/Reflection test set) and the return port (Input B of the analyzer).
19. Press **FWD ISOL'N ISOL'N STD**. S_{21} isolation is measured, and the softkey label is underlined.
20. Press **ISOLATION DONE**. The isolation error coefficients are stored. The two-port cal menu is displayed, with the **ISOLATION** softkey underlined.
21. Press **DONE 2-PORT CAL** to complete the calibration. The error coefficients are computed and stored. The correction menu is displayed with **CORRECTION ON**. A corrected trace is displayed, and the notation "C2" at the left of the screen indicates that 2-port error correction is ON.

Now the test device can be connected and measured in the forward direction. When forward measurement is complete, disconnect the test device and manually reverse it, then press the **PRESS to CONTINUE** key.

It is recommended that calibration data be saved on a disk. Refer to Chapter 11.

MODIFYING CALIBRATION KITS

Note



Hewlett-Packard strongly recommends that you read application note 8510-5A before attempting to view or modify calibration standard definitions. The part number of this application note is 5956-4352. Although the application note is written for the HP 8510 family of network analyzers, it also applies to the HP 8751A. This portion of the calibration chapter provides a summary of the information in the application note, as well as HP 8751A menu-specific information.

For most applications, use the default cal kit models provided in the select cal kit menu described earlier in this chapter. Modifying calibration kits is necessary only if unusual standards are used or the very highest accuracy is required. Unless a cal kit model is provided with the calibration devices used, a solid understanding of error correction and the system error model are absolutely essential to making modifications. Read the introductory part of this chapter for more information, and refer to the Appendix to Chapter 7.

Note



Numerical data for most Hewlett-Packard calibration kits is provided in the calibration kit manuals.

During measurement calibration, the analyzer measures actual, well-defined standards and mathematically compares the results with ideal “models” of those standards. The differences are separated into error terms which are later reduced during error correction. Most of the differences are due to systematic errors - repeatable errors introduced by the analyzer, test set, and cables - which are correctable. However, the difference between the standard’s mathematical *model* and its *actual performance* has an adverse affect; it reduces the system’s ability to remove systematic errors, and thus degrades error-corrected accuracy. Therefore, in addition to the default cal kit models, a “user kit” is provided that can be modified to an alternate calibration standards model.

Several situations exist that may require a user-defined cal kit:

- You use a connector interface different from the three built-in cal kits. (Examples: SMA, or BNC.)
- You are using standards (or combinations of standards) that are different from the predefined cal kits. (Example: Using three offset SHORTs instead of OPEN, SHORT, and LOAD to perform a 1-port calibration.)
- You want to improve the built-in standard models for predefined kits. Remember that the more closely the model describes the actual performance of the standard, the better the calibration. (Example: The 7 mm LOAD is determined to be 50.4 Ω instead of 50.0 Ω .)
- Unused standards for a given cal type can be eliminated from the default set, to eliminate possible confusion during calibration. (Example: A certain application requires calibrating a male test port. The standards used to calibrate a female test port can be eliminated from the set, and will not be displayed during calibration.)

Definitions

The following are definitions of terms:

- A **standard** is a specific, well-defined, physical device used to determine systematic errors.
- A **standard type** is one of five basic types that define the form or structure of the model to be used with that standard (e.g. SHORT or LOAD).
- Standard **coefficients** are numerical characteristics of the standards used in the model selected.
- A **standard class** is a grouping of one or more standards that determines which standards are used in a particular calibration procedure.

Procedure

The following steps are used to modify or define a user kit:

1. Select the predefined kit to be modified. This is not necessary for defining a new cal kit.
2. Define the standards. For each standard, define which *type* of standard it is and its electrical characteristics.
3. Specify the *class* where the standard is to be assigned.
4. Store the modified cal kit.

The standard definitions of predefined calibration kits are shown in Appendix A.

Modify Cal Kit Menu

This menu is accessed from **CAL** **CAL KIT** **MODIFY** (refer to Figure 7-6), and leads to additional menus associated with modifying cal kits. The analyzer directly supports 7 mm, 50Ω type-N, and 75Ω type-N connector types.

For other connector types, you must modify the existing standards definitions. This menu provides access to the default calibration standards definitions. A “User Kit” is provided for convenience. It can be redefined without affecting the definitions.

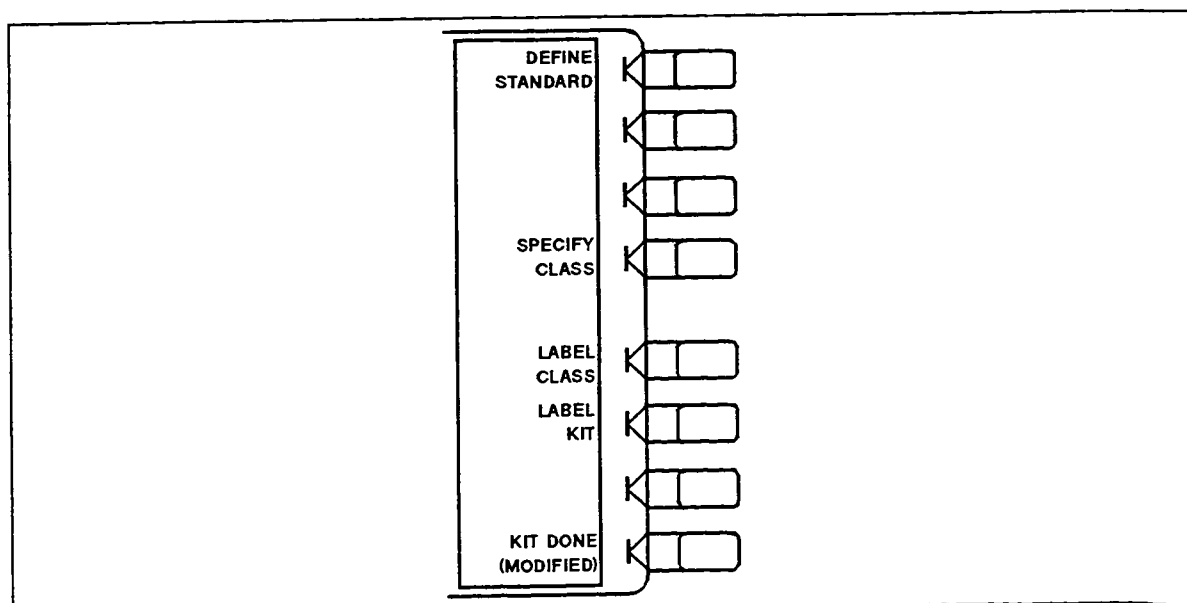

C2007027

Figure 7-18. Modify Cal Kit Menu

Modifying Calibration Kits

DEFINE STANDARD (DEFS) makes the standard number the active function, and brings up the define standard number menus. The standard number (1 to 8) is an arbitrary reference number used to reference standards while specifying a class. Each number is similar to a register, in that it holds certain information. Each contains the selected type of device (OPEN, SHORT, or THRU) and the electrical model for that device. The standard numbers for the predefined calibration kits are as follows:

1 SHORT	5 LOAD
2 OPEN	6 LOAD
3 LOAD	7 SHORT
4 DEL/THRU	8 OPEN

SPECIFY CLASS leads to the specify class menu. After the standards are modified, use this key to specify a class to consist of certain standards.

LABEL CLASS leads to the label class menu, to give the class a meaningful label for future reference.

LABEL KIT (LABK) leads to a menu for constructing a label for the user-modified cal kit. If a label is supplied, it will appear as one of the five softkey choices in the select cal kit menu. The approach is similar to defining a display title, except that the kit label is limited to ten characters. Refer to **DISPLAY** Key, Title Menu in Chapter 6 for details.

KIT DONE (KITD) terminates the cal kit modification process, after all standards are defined and all classes are specified. Be sure to save the kit with the **SAVE USER KIT** softkey, if it is to be used later.

Define Standard Number Menu

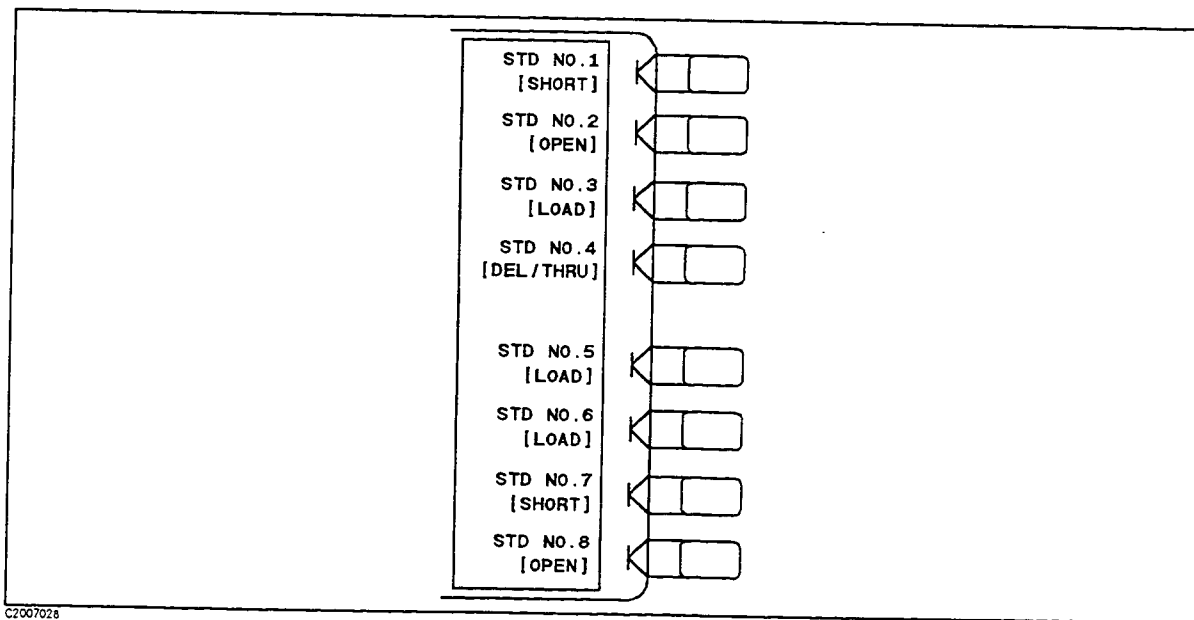

Figure 7-19. Define Standard Number Menu

STD NO. 1 selects standard No.1 as the standard definition.

STD NO. 2 selects standard No.2 as the standard definition.

STD NO. 3 selects standard No.3 as the standard definition.

Modifying Calibration Kits

- STD NO. 4** selects standard No.4 as the standard definition.
STD NO. 5 selects standard No.5 as the standard definition.
STD NO. 6 selects standard No.6 as the standard definition.
STD NO. 7 selects standard No.7 as the standard definition.
STD NO. 8 selects standard No.8 as the standard definition.

Define Standard Menus

Standard definition is the process of mathematically modeling the electrical characteristics (delay, attenuation, and impedance) of each calibration standard. These electrical characteristics (coefficients) can be mathematically derived from the physical dimensions and material of each calibration standard, or from its actual measured response. The parameters of the standards can be listed in Standards Definitions, Table 7-3. The menus illustrated in Figure 7-20 specify the type and characteristics for each user-defined standard.

Table 7-3. Standard Definitions

NO.	STANDARD TYPE	C0 $\times 10^{-15} \text{ F}$	C1 $\times 10^{-27} \text{ F/Hz}$	C2 $\times 10^{-36} \text{ F/Hz}^2$	OFFSET DELAY ps	OFFSET LOSS M Ω /s	OFFSET Z ₀ Ω	STANDARD LABEL
1								
2								
3								
4								
5								
6								
7								
8								

Each standard must be identified as one of five “types”: OPEN, SHORT, LOAD, DELAY/THRU, or arbitrary impedance.

After a standard number is entered, selection of the standard type will present one of five menus for entering the electrical characteristics (model coefficients) corresponding to that standard type. These menus are tailored to the current type, so that only characteristics applicable to the standard type can be modified.

Any standard type can be further defined with offsets in delay, loss, and standard impedance (Z₀). Press the **SPECIFY OFFSET** key, and refer to the specify offset menu.

A distinct label can be defined and assigned to each standard, so that the analyzer can prompt the user with explicit standard labels during calibration (e.g. “SHORT”). Press the **LABEL STD** softkey. The function is similar to defining a display title, except that the label is limited to ten characters. Refer to **DISPLAY** Key, “Title Menu” in Chapter 6 for details.

After each standard is defined, including offsets, press **STD DONE (DEFINED)** to terminate the standard definition.

The standard definitions can be listed on screen and printed using COPY function. (Refer to Chapter 10.)

Modifying Calibration Kits

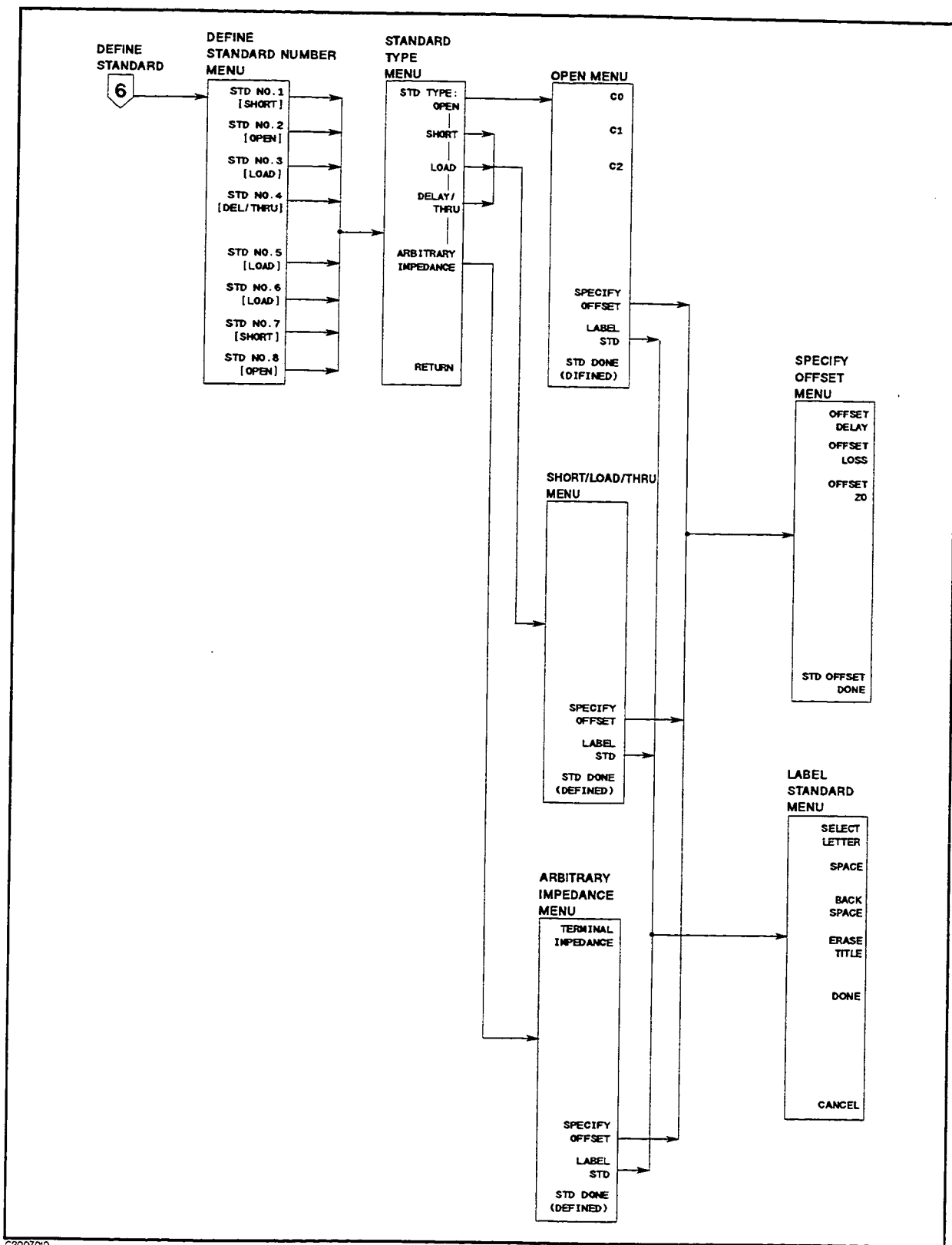

C2007010

Figure 7-20. Define Standard Menus

Modifying Calibration Kits

OPEN (STDTOPEN) defines the standard type as an OPEN, used for calibrating reflection measurements. OPENs are assigned a terminal impedance of infinite ohms, but delay and loss offsets may still be added. Pressing this key also brings up a menu for defining the OPEN, including its capacitance.

As a reflection standard, an OPEN offers the advantage of broadband frequency coverage. However, an OPEN rarely has perfect reflection characteristics because fringing (capacitance) effects cause phase shift that varies with frequency. This can be observed in measuring an OPEN termination after calibration, when an arc in the lower right circumference of the Smith chart indicates capacitive reactance. These effects are impossible to eliminate, but the calibration kit models include the OPEN termination capacitance at all frequencies for compatible calibration kits. The capacitance model is a second order polynomial (squared term), as a function of frequency, where the polynomial coefficients are user-definable. The capacitance model equation is:

$$C = C_0 + C_1 \times F + C_2 \times F^2$$

where F is the measurement frequency.

The terms in the equation are defined with the specify open menu as follows:

C0 (C0) enters the C_0 term, which is the constant term of the quadratic equation and is scaled by 10^{-15} Farads.

C1 (C1) enters the C_1 term, expressed in F/Hz (Farads/Hz) and scaled by 10^{-27} .

C2 (C2) enters the C_2 term, expressed in F/Hz² and scaled by 10^{-36} .

SHORT (STDTSHOR) defines the standard type as a SHORT, for calibrating reflection measurements. SHORTs are assigned a terminal impedance of 0 Ω , but delay and loss offsets may still be added.

LOAD (STDTLOAD) defines the standard type as a LOAD (termination). LOADs are assigned a terminal impedance equal to the system characteristic impedance Z_0 , but delay and loss offsets may still be added. If the LOAD impedance is not Z_0 , use the arbitrary impedance standard definition.

DELAY/THRU (STDTDELA) defines the standard type as a transmission line of specified length, for calibrating transmission measurements.

ARBITRARY IMPEDANCE (STDTARBI) defines the standard type to be a LOAD, but with an arbitrary impedance (different from system Z_0).

TERMINAL IMPEDANCE (TERI) specifies the (arbitrary) impedance of the standard, in ohms.

STD DONE(DEFINED) terminates the standard definition. Press this after each standard defined, including offsets.

Specify Offset Menu

The specify offset menu allows additional specifications for a user-defined standard. Features specified in this menu are common to all five types of standards.

Offsets may be specified with any standard type. This means defining a uniform length of transmission line to exist between the standard being defined and the actual measurement plane. For reflection standards, the offset is assumed to be between the measurement plane and the standard (one-way only). For transmission standards, the offset is assumed to exist between the two reference planes (in effect, the offset is the THRU). Three characteristics of the offset can be defined: its delay (length), loss, and impedance.

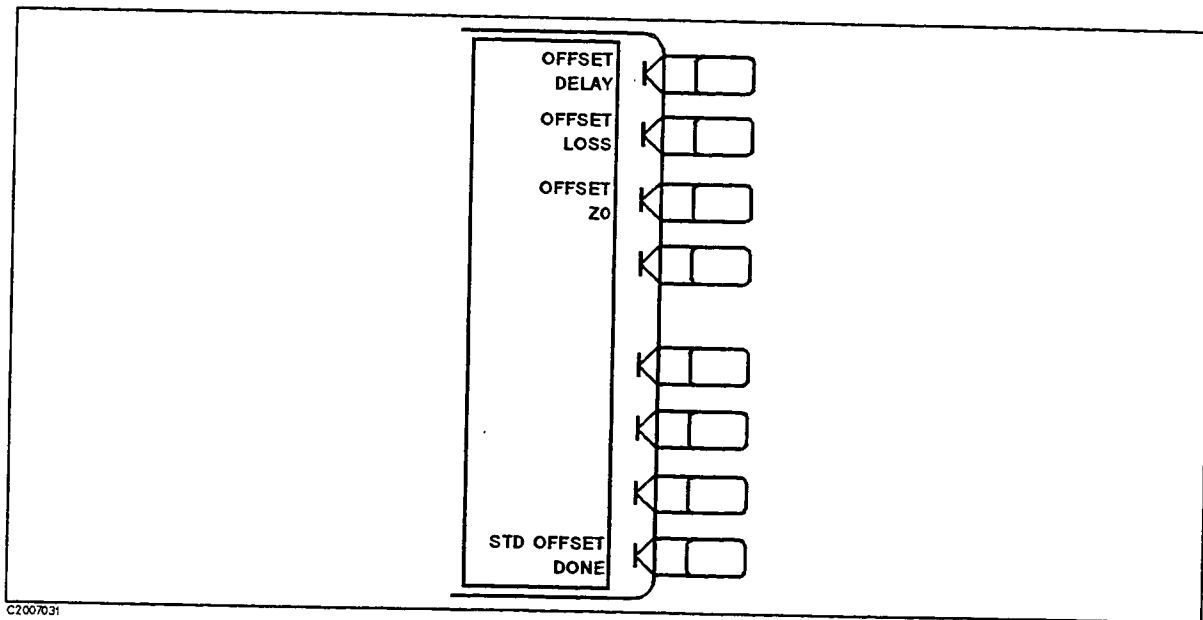

Figure 7-21. Specify Offset Menu

OFFSET DELAY (OFSD) specifies the one-way electrical delay from the measurement (reference) plane to the standard, in seconds (s). (In a transmission standard, offset delay is the delay from plane to plane.) Delay can be calculated from the precise physical length of the offset, the permittivity constant of the medium, and the speed of light.

OFFSET LOSS (OFSL) specifies energy loss, due to skin effect, along a one-way length of coaxial cable offset. The value of loss is entered as ohms/nanosecond (or Giga ohms/second) at 1 GHz.

OFFSET Z0 (OFSZ) specifies the characteristic impedance of the coaxial cable offset.

Note This is not the impedance of the standard itself.



Modifying Calibration Kits

Label Standard Menu

This menu labels (reference) individual standards during the menu-driven measurement calibration sequence. The labels are user-definable using a character set displayed on the display that includes letters, numbers, and some symbols, and they may be up to ten characters long. The analyzer will prompt you to connect standards using these labels, so they should be meaningful to you, and distinct for each standard.

By convention, when sexed connector standards are labeled male (m) or female (f), the designation refers to the test port connector sex, not the connector sex of the standard.

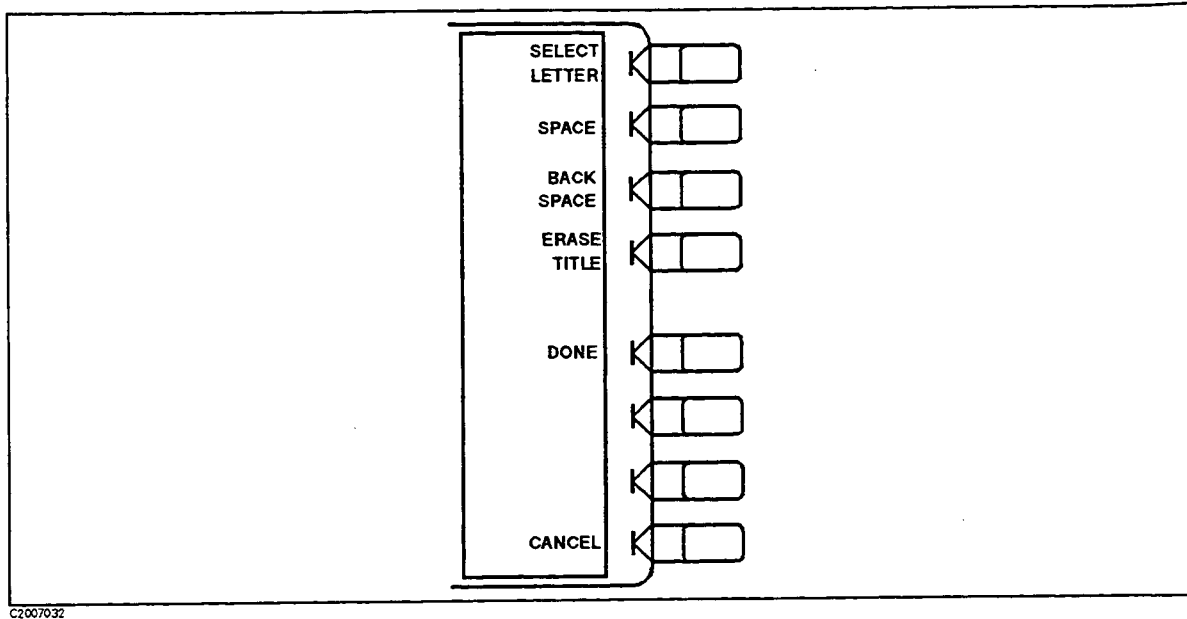

Figure 7-22. Label Standard Menu

Standard labels are created in the same way as titles. Refer to “**DISPLAY** KEY” in Chapter 6, “Title Menu” in Chapter 6.

Modifying Calibration Kits

Specify Class Menus

Once a standard is specified, it must be assigned to a standard *class*. This is a group of from one to seven standards that is required to calibrate for a single error term. The standards within a single class are assigned to locations A through G as listed on the Standard Class Assignments Table (Table 7-4). A class often consists of a single standard, but may be composed of more than one standard.

The standard class assignments of predefined standard kits are shown in Appendix A.

Table 7-4. Standard Class Assignments Table

CLASS	A	B	C	D	E	F	G	STANDARD CLASS LABEL
S _{11A}								
S _{11B}								
S _{11C}								
S _{22A}								
S _{22B}								
S _{22C}								
Forward Transmission								
Reverse Transmission								
Forward Match								
Reverse Match								
Response								
Response & Isolation								

The number of standard classes required depends on the type of calibration being performed, and is identical to the number of error terms corrected. (Examples: A response cal requires only one class, and the standards for that class may include an OPEN, or SHORT, or THRU. A 1-port cal requires three classes. A full 2-port cal requires 10 classes, not including two for isolation.)

The number of standards that can be assigned to a given class may vary from none (class not used) to one (simplest class) to seven. When a certain class of standards is required during calibration, the analyzer will display the labels for all the standards in that class (except when the class consists of a single standard). This does not, however, mean that all standards in a class must be measured during calibration. Only a single standard per class is required. Note that it is often simpler to keep the number of standards per class to the bare minimum needed (often one) to avoid confusion during calibration.

Standards are assigned to a class simply by entering the standard's reference number (established while defining a standard) under a particular class.

Each class can be given a user-definable label as described under "Label Class Menus".

Modifying Calibration Kits

The class assignments table can be displayed on screen and printed using COPY function. (Refer to Chapter 10.)

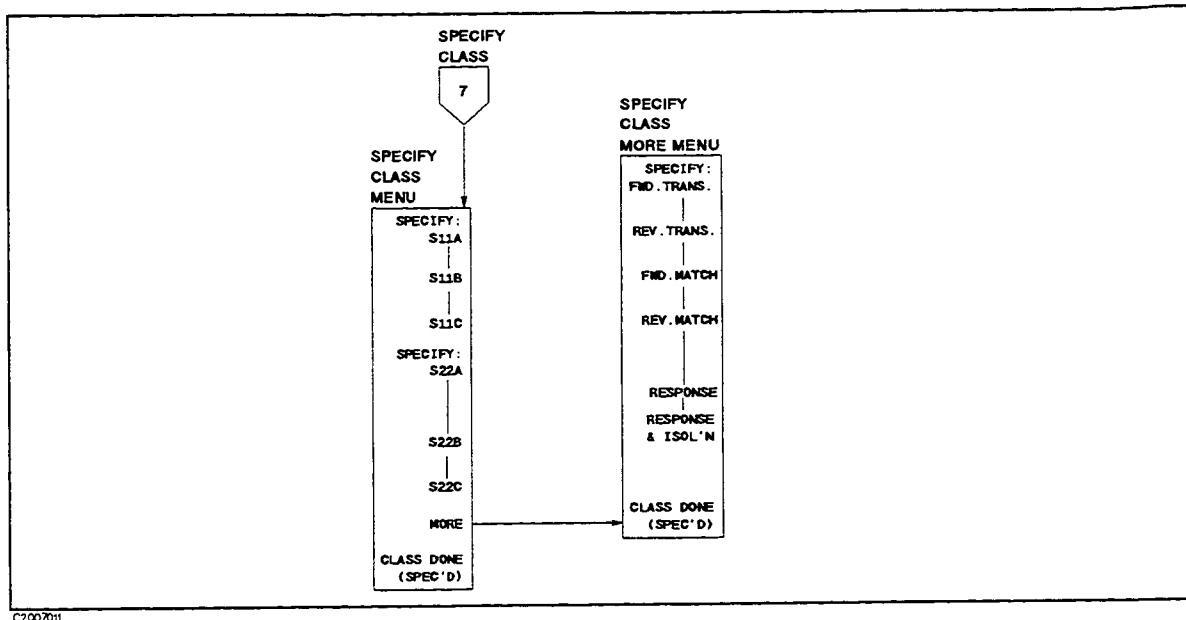

Figure 7-23. Specify Class Menus

SPECIFY: S11A (SPECS11A) enters the standard numbers for the first class required for an S_{11} 1-port calibration. (For predefined cal kits, this is OPEN (for the 7 mm) or OPENS (for type-N).)

S11B (SPECS11B) enters the standard numbers for the second class required for an S_{11} 1-port calibration. (For predefined cal kits, this is SHORT (for the 7 mm) or SHORTS (for the type-N).)

S11C (SPECS11C) enters the standard numbers for the third class required for an S_{11} 1-port calibration. (For predefined kits, this is the LOAD.)

SPECIFY: S22A (SPECS22A) enters the standard numbers for the first class required for an S_{22} 1-port calibration. (For predefined cal kits, this is OPEN (for the 7 mm) or OPENS (for the type-N).)

S22B (SPECS22B) enters the standard numbers for the second class required for an S_{22} 1-port calibration. (For predefined cal kits, this is SHORT (for the 7 mm) or SHORTS (for the type-N).)

S22C (SPECS22C) enters the standard numbers for the third class required for an S_{22} 1-port calibration. (For predefined kits, this is the LOAD.)

MORE leads to the following softkeys.

FWD. TRANS. (SPECFWDT) enters the standard numbers for the forward transmission (THRU) calibration. (For predefined kits, this is the THRU.)

REV. TRANS. (SPECREVT) enters the standard numbers for the reverse transmission (THRU) calibration. (For predefined kits, this is the THRU.)

Modifying Calibration Kits

FWD.MATCH (SPECFWD) enters the standard numbers for the forward match (THRU) calibration. (For predefined kits, this is the THRU.)

REV.MATCH (SPECREVM) enters the standard numbers for the reverse match (THRU) calibration. (For predefined kits, this is the THRU.)

RESPONSE (SPECRESP) enters the standard numbers for a response calibration. This calibration corrects for frequency response in either reflection or transmission measurements, depending on the parameter being measured when a calibration is performed. (For predefined kits, the standard is either the OPEN or SHORT for reflection measurements, or the THRU for transmission measurements.)

RESPONSE & ISOL'N (SPECRESI) enters the standard numbers for a response & isolation calibration. This calibration corrects for frequency response and directivity in reflection measurements, or frequency response and isolation in transmission measurements.

Label Class Menus

These define meaningful labels for the calibration classes. These then become softkey labels during a measurement calibration. Labels can be up to ten characters long.

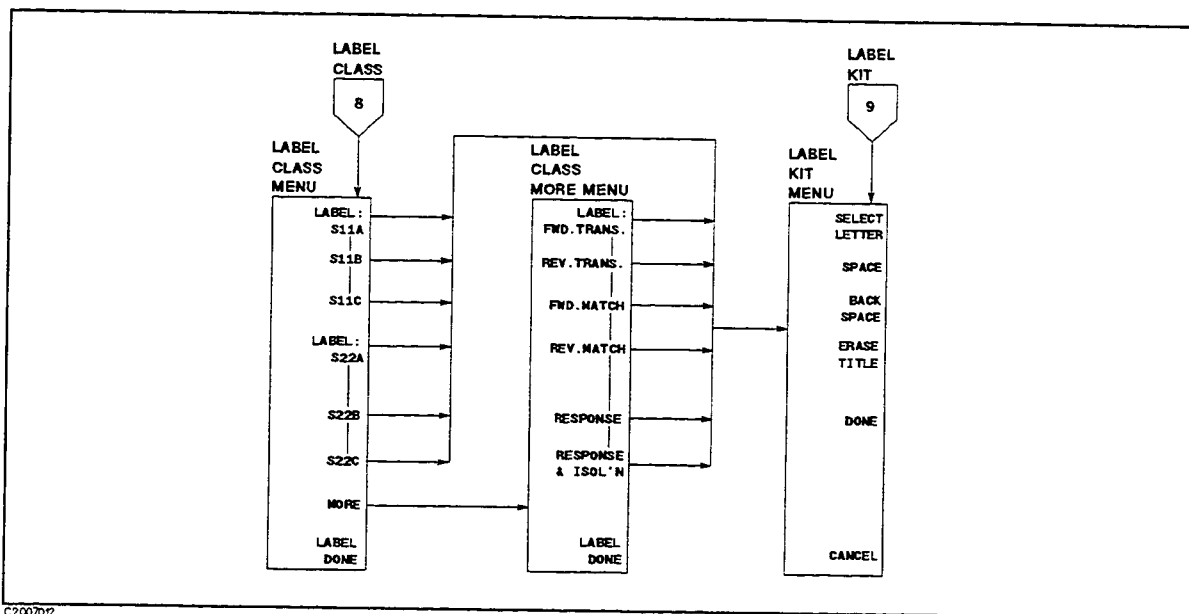

Figure 7-24. Label Class Menus

Labels are created in the same way as display titles. Refer to **DISPLAY** Key, "Title Menu" in Chapter 6.

Modifying Calibration Kits

Label Kit Menu

After a new calibration kit has been defined, be sure to specify a label for it. Choose a label that describes the connector type of the calibration devices. This label will then appear in the **CAL KIT** softkey label in the correction menu and the **MODIFY** label in the select cal kit menu. It will be saved with calibration data.

This menu is accessed with the **LABEL KIT** softkey in the modify cal kit menu, and is identical to the label class menu and the label standard menu described above. It allows definition of a label up to eight characters long.

Verify Performance

Once a measurement calibration has been generated with a user-defined calibration kit, its performance should be checked before making device measurements. To check the accuracy that can be obtained using the new calibration kit, a device with a well-defined frequency response should be measured. The verification device must not be one of the calibration standards: measurement of one of these standards is merely a measure of repeatability.

To achieve more complete verification of a particular measurement calibration, accurately known verification standards with a diverse magnitude and phase response should be used. NIST traceable or HP standards are recommended to achieve verifiable measurement accuracy.

Note



The published specifications for the HP 8751A network analyzer system include accuracy enhancement with compatible calibration kits. Measurement calibrations made with user-defined or modified calibration kits are not subject to the HP 8751A specifications, although a procedure similar to the system verification procedure may be used.

Example Procedure for Specifying a User-Defined Calibration Kit

The following procedure enters the HP 85033C 3.5 mm calibration kit values as a "user kit." This is provided as an example to illustrate the steps required in defining a calibration kit model.

Note



Numerical data for most Hewlett-Packard calibration kits is provided in the calibration kit manuals.

Note



User defined calibration kits are saved to disk when you save ALL. This is a convenient way to save calibration kits for future use.

Parameters of 3.5 mm standard calibration kit are as follows:

Table 7-5. 3.5 mm Standard Cal Kit

NO.	STANDARD TYPE	C0 $\times 10^{-15} \text{ F}$	C1 $\times 10^{-27} \text{ F/Hz}$	C2 $\times 10^{-36} \text{ F/Hz}^2$	OFFSET DELAY ps	OFFSET LOSS M Ω /s	OFFSET Z ₀ Ω	STANDARD LABEL
1	SHORT				16.695	1300	50	SHORT
2	OPEN	53	150	0	14.491	1300	50	OPEN
3	LOAD				0	1300	50	BROADBAND
4	DELAY/THRU				0	1300	50	THRU

To Define Standards

1. The first keystroke sequence enters the values for standard number 1, the SHORT.
 - a. **CAL** CAL KIT MODIFY
 - b. DEFINE STANDARD STD NO.1 [SHORT] SHORT
 - c. SPECIFY OFFSET OFFSET DELAY .016695 **G/n**
 - d. OFFSET LOSS 1300 **M/ μ**
 - e. OFFSET Z₀ 50 **X1**
 - f. STD OFFSET DONE
 - g. LABEL STD
 - h. Use the rotary knob, the **↓**, **↑** keys and softkeys to modify the label to read "SHORT"
 - i. DONE
 - j. STD DONE (DEFINED)
2. The next sequence specifies standard number 2, the OPEN.
 - a. DEFINE STANDARD STD NO.2 [OPEN] OPEN
 - b. C0 53 **X1**
 - c. C1 150 **X1**
 - d. C2 0 **X1**
 - e. SPECIFY OFFSET OFFSET DELAY .014491 **G/n**
 - f. OFFSET LOSS 1300 **M/ μ**
 - g. OFFSET Z₀ 50 **X1**
 - h. STD OFFSET DONE
 - i. LABEL STD
 - j. Use the rotary knob, the **↓**, **↑** keys and softkeys to modify the label to read "OPEN"
 - k. DONE
 - l. STD DONE (DEFINED)
3. The next sequence specifies standard number 3, the LOAD.
 - a. DEFINE STANDARD STD NO.3 [LOAD] LOAD
 - b. SPECIFY OFFSET OFFSET DELAY 0 **G/n**
 - c. OFFSET LOSS 1300 **M/ μ**
 - d. OFFSET Z₀ 50 **X1**
 - e. STD OFFSET DONE

Modifying Calibration Kits

- f. LABEL STD
 - g. Use the rotary knob, the \downarrow , \uparrow keys and softkeys to modify the label to read "BROADBAND"
 - h. DONE
 - i. STD DONE (DEFINED)
4. The next sequence specifies standard number 4, the DELAY/THRU.
- a. DEFINE STANDARD STD NO 4 [DEL/THRU] DEL/THRU
 - b. SPECIFY OFFSET OFFSET DELAY 0 (G/n)
 - c. OFFSET LOSS 1300 (M/ μ)
 - d. OFFSET Z₀ 50 (X1)
 - e. STD OFFSET DONE
 - f. LABEL STD
 - g. Use the rotary knob, the \downarrow , \uparrow keys and softkeys to modify the label to read "THRU"
 - h. DONE
 - i. STD DONE (DEFINED)

To Define Class Assignment

5. The next sequence defines class assignment as shown in Table 7-6

Table 7-6.
Standard Class Assignments Table for User-Defined Calibration Kit

CLASS	A	B	C	D	E	F	G	STANDARD CLASS LABEL
S _{11A}	2							OPEN
S _{11B}	1							SHORT
S _{11C}	3							LOAD
S _{22A}	2							OPEN
S _{22B}	1							SHORT
S _{22C}	3							LOAD
Forward Transmission	4							THRU
Reverse Transmission	4							THRU
Forward Match	4							THRU
Reverse Match	4							THRU
Response	1	2	4					RESPONSE
Response & Isolation	1	2	4					RESPONSE

- a. SPECIFY CLASS
- b. SPECIFY: S_{11A} 2 (X1) S_{11B} 1 (X1) S_{11C} 3 (X1)
- c. S_{22A} 2 (X1) S_{22B} 1 (X1) S_{22C} 3 (X1)
- d. MORE SPECIFY: FWD. TRANS. 4 (X1) REV. TRANS. 4 (X1)
- e. FWD. MATCH 4 (X1) REV. MATCH 4 (X1)
- f. RESPONSE 1 (X1) 2 (X1) 4 (X1)

Modifying Calibration Kits

- g. RESPONSE & ISOL'N 1 X1 2 X1 4 X1
 - h. CLASS DONE (SPEC'D)
6. The next sequence labels the standard class.
- a. LABEL CLASS
 - b. LABEL S11A
 - c. Use the rotary knob, the ↓, ↑ keys and softkeys to modify the label to read "OPEN"
 - d. DONE
 - e. Press S11B, modify the label to read "SHORT" and press DONE
 - f. Press S11C, modify the label to read "LOAD" and press DONE
 - g. Press S22A, modify the label to read "OPEN" and press DONE
 - h. Press S22B, modify the label to read "SHORT" and press DONE
 - i. Press S22C, modify the label to read "LOAD" and press DONE
 - j. Press MORE LABEL FWD TRANS., modify the label to read "THRU" and press DONE
 - k. Press REV TRANS., modify the label to read "THRU" and press DONE
 - l. Press FWD MATCH, modify the label to read "THRU" and press DONE
 - m. Press REV MATCH, modify the label to read "THRU" and press DONE
 - n. Press RESPONSE, modify the label to read "RESPONSE" and press DONE
 - o. Press RESPONSE & ISOL'N, modify the label to read "RESPONSE" and press DONE
 - p. LABEL DONE

To Label and Save Calibration Kit

7. The final sequence labels the kit and saves it in memory.
- a. LABEL KIT
 - b. Use the rotary knob, the ↓, ↑ keys and softkeys to modify the label to read "3.5mmC".
 - c. DONE KIT DONE (MODIFIED)
 - d. CAL KIT [3.5mmC]
 - e. SAVE USER KIT
 - f. USER KIT

The USER KIT softkey is now underlined.

Note



You must press SAVE USER KIT to save your definition after User-Defined Calibration Kit is modified. If you change calibration kit before saving, calibration kit definition is overwritten and the definition modified is lost.

After User-Defined Calibration Kit is defined, you can verify them using Copy function that list standard parameters and class assignment defined.

To Verify Definition of User-Defined Calibration Kit

1. Calibration kit must be specified as **USER KIT** in the Select Cal Kit menu at first.
 - a. **CAL USER KIT**
2. To display the standard parameters defined.
 - a. **COPY MORE CAL KIT DEFINITION**
 - b. Press softkey labeled standard number you want to list parameters defined.
 - c. To make a hardcopy, press **PRINT [STANDARD]**.
 - d. **RESTORE DISPLAY**
3. To display the class assignment defined.
 - a. **CLASS ASSIGNMENT**
 - b. To make a hardcopy, press **PRINT [STANDARD]**.

APPENDIX TO CHAPTER 7

Accuracy Enhancement Fundamentals-Characterizing Systematic Errors

One-Port Error Model

In a measurement of the reflection coefficient (magnitude and phase) of an unknown device, the measured data differs from the actual, no matter how carefully the measurement is made. Directivity, source match, and reflection signal path frequency response (tracking) are the major sources of error (Figure 7-25).

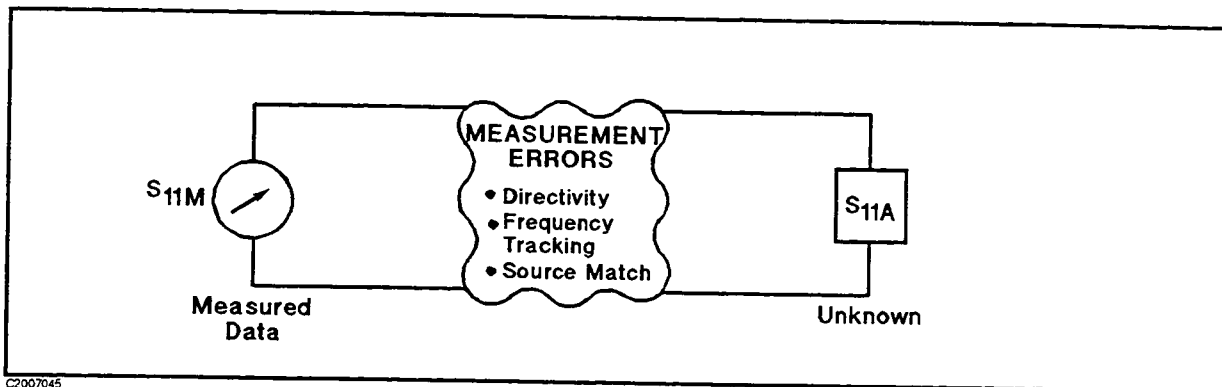

Figure 7-25. Sources of Error in a Reflection Measurement

Measuring reflection coefficient. The reflection coefficient is measured by first separating the incident signal (I) from the reflected signal (R), then taking the ratio of the two values (Figure 7-26). Ideally, (R) consists only of the signal reflected by the test device (S_{11A}).

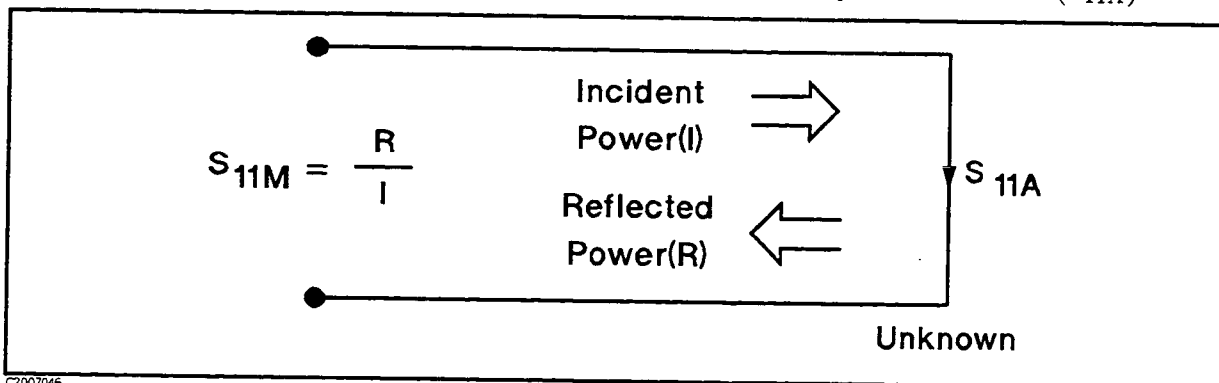
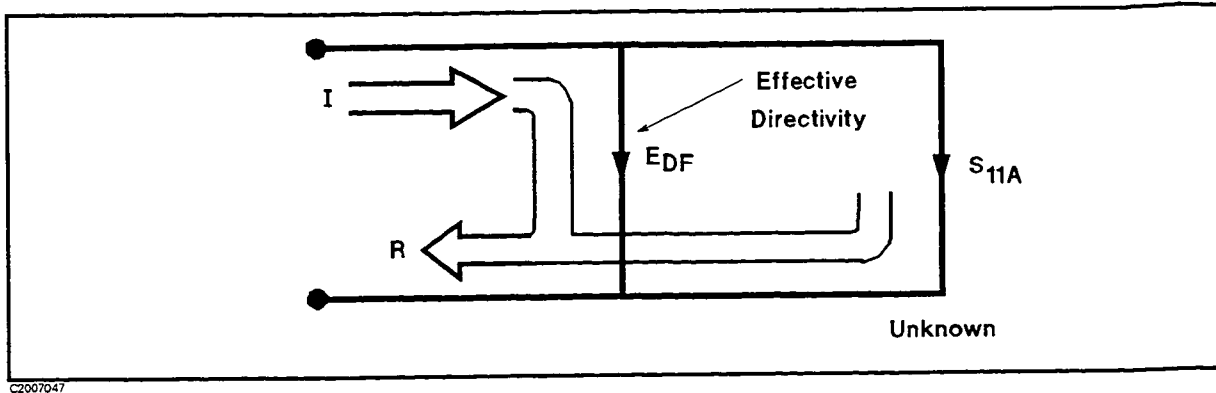

Figure 7-26. Reflection Coefficient

Directivity error. However, all of the incident signal does not always reach the unknown (see Figure 7-27). Some of (I) may appear at the measurement system input due to leakage through the test set or other signal separation device. Also, some of (I) may be reflected by imperfect adapters between signal separation and the measurement plane. The vector sum of the leakage and miscellaneous reflections is directivity, E_{DF} . Understandably, the measurement is distorted when the directivity signal combines vectorally with the actual reflected signal from the unknown, S_{11A} .

Accuracy Enhancement Fundamentals-Characterizing Systematic Errors

Figure 7-27. Effective Directivity E_{DF}

Source match error. Since the measurement system test port is never exactly the characteristic impedance (50Ω or 75Ω), some of the reflected signal is re-reflected off the test port, or other impedance transitions further down the line, and back to the unknown, adding to the original incident signal (I). This effect causes the magnitude and phase of the incident signal to vary as a function of S_{11A} and frequency. Leveling the source to produce constant (I) reduces this error, but since the source cannot be exactly leveled at the test device input, leveling cannot eliminate all power variations. This re-reflection effect and the resultant incident power variation are caused by the source match error, E_{SF} (Figure 7-28).

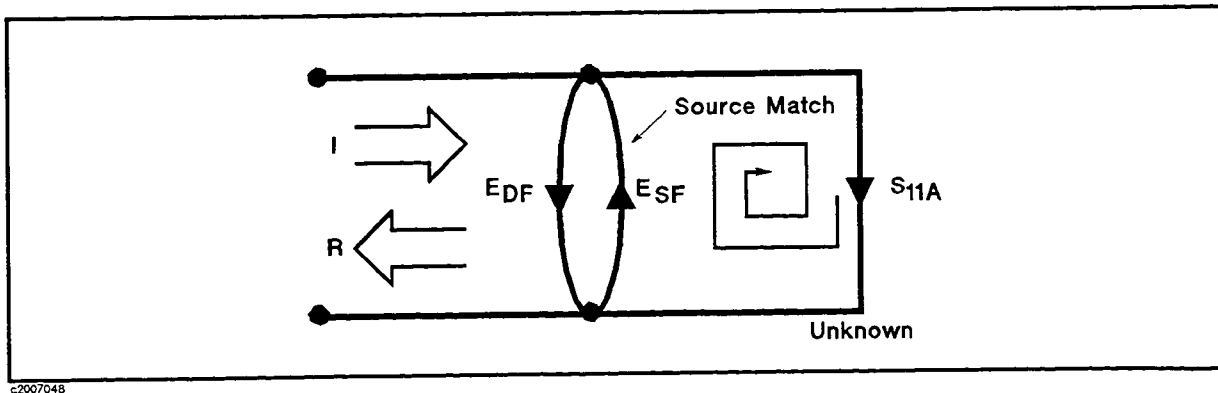
Figure 7-28. Source Match E_{SF}

Frequency response error. Frequency response (tracking) error is caused by variations in magnitude and phase flatness versus frequency between the test and reference signal paths. These are due mainly to imperfectly matched receiver circuits and differences in length and loss between incident and test signal paths. The vector sum of these variations is the reflection signal path tracking error, E_{RF} (Figure 7-29).

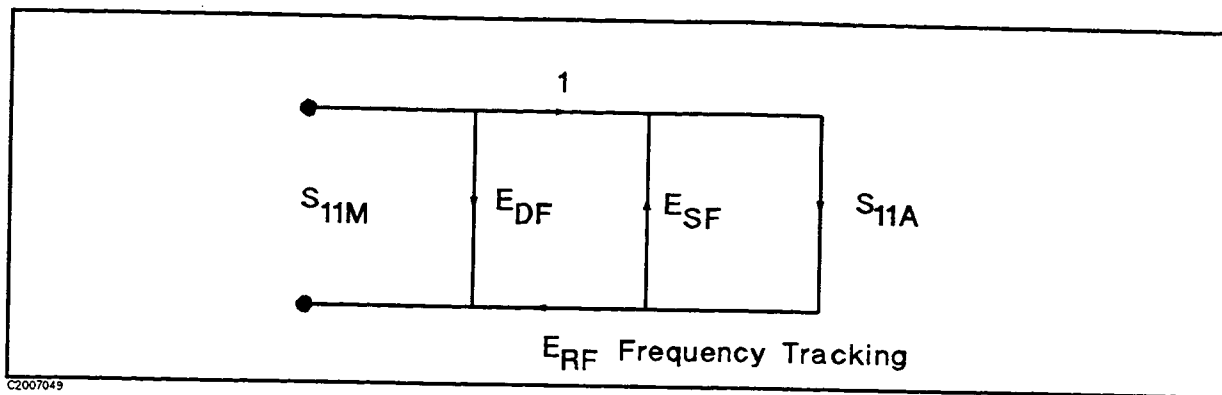

Figure 7-29. Reflection Tracking E_{RF}

How calibration standards are used to quantify these error terms. It can be shown that these three errors are mathematically related to the actual data, S_{11A} , and measured data, S_{11M} , by the following equation:

$$S_{11M} = E_{DF} + \frac{S_{11A}(E_{RF})}{1 - E_{SF}S_{11A}}$$

If the value of these three “E” errors and the measured test device response were known for each frequency, the above equation could be solved for S_{11A} to obtain the actual test device response. Because each of these errors changes with frequency, their values must be known at each test frequency. These values are found by measuring the system at the measurement plane using three independent standards whose S_{11A} is known at all frequencies.

The first standard applied is a “perfect load”, which makes $S_{11A} = 0$ and essentially measures directivity (Figure 7-30). “Perfect load” implies a reflectionless termination at the measurement plane. All incident energy is absorbed. With $S_{11A} = 0$ the equation can be solved for E_{DF} , the directivity term. In practice, of course, the “perfect load” is difficult to achieve, although very good broadband LOADs are available in the HP 8751A compatible calibration kits.

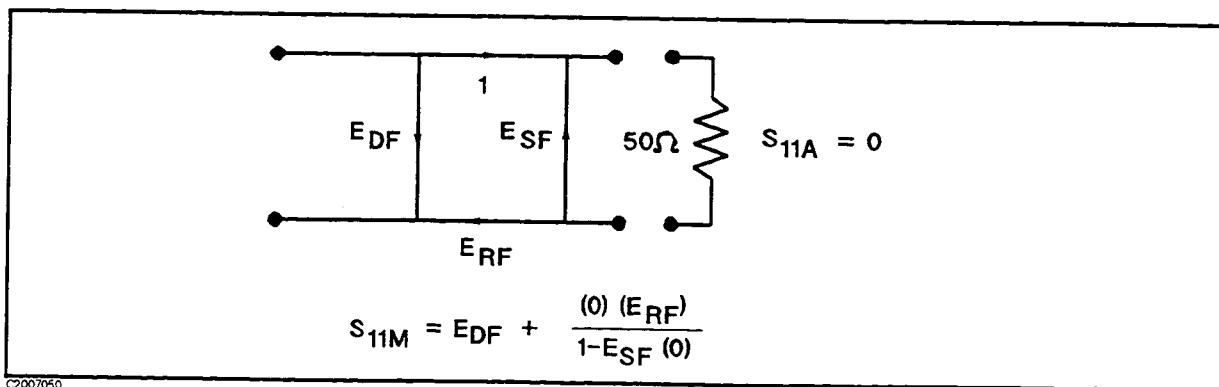
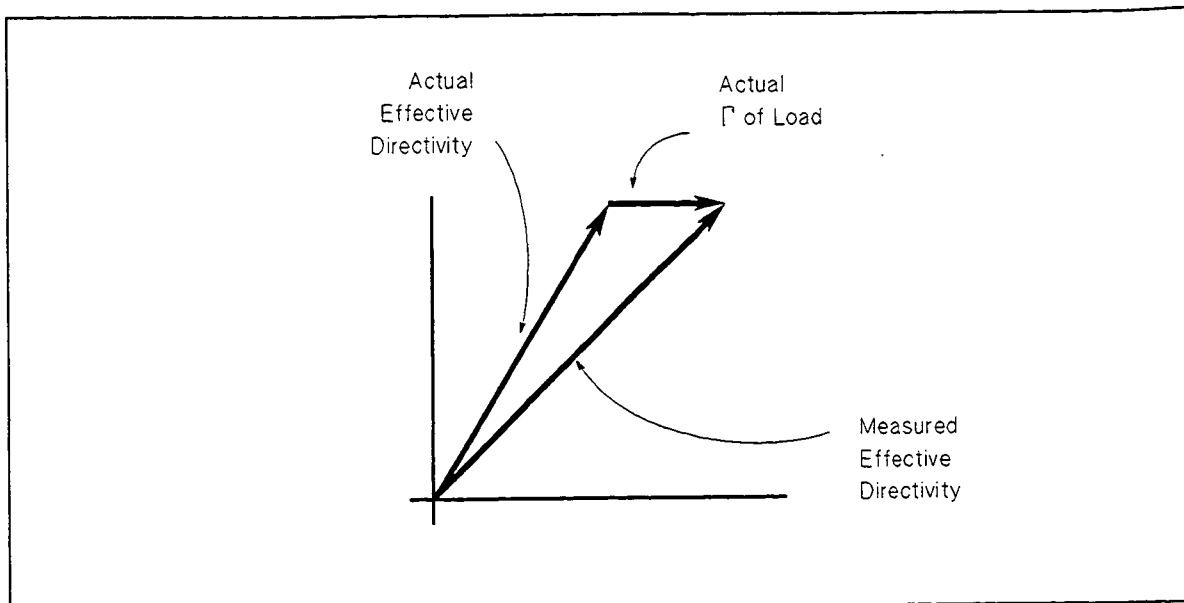

Figure 7-30. “Perfect Load” Termination

Since the measured value for directivity is the vector sum of the actual directivity plus the actual reflection coefficient of the “perfect load”, any reflection from the termination represents an error. System effective directivity becomes the actual reflection coefficient of the “perfect load” (Figure 7-31). In general, any termination having a return loss value greater than the uncorrected system directivity reduces reflection measurement uncertainty.



C2007051

Figure 7-31. Measured Effective Directivity

Next, a SHORT termination whose response is known to a very high degree establishes another condition (Figure 7-32).

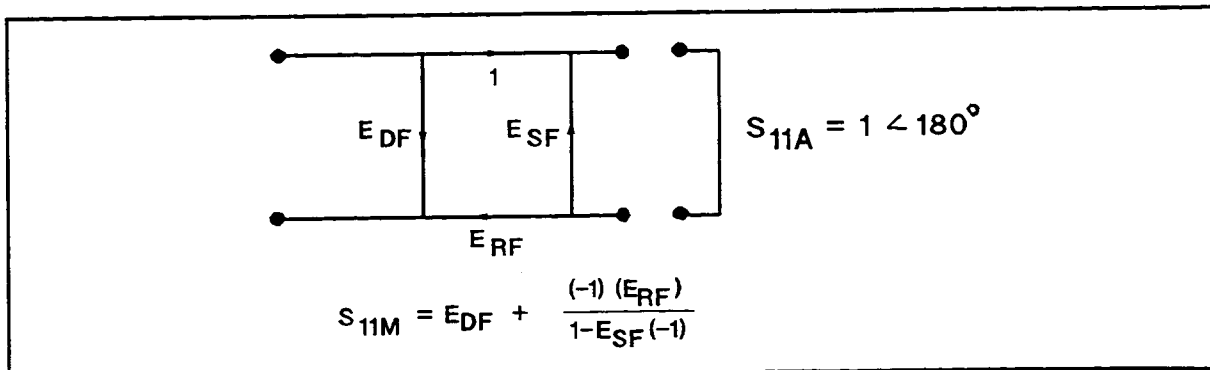

C2007052

Figure 7-32. Short Circuit Termination

The OPEN gives the third independent condition. In order to accurately model the phase variation with frequency due to radiation from the OPEN connector, a specially designed shielded OPEN is used for this step. (The OPEN capacitance is different with each connector type). Now the values for E_{DF} , directivity, E_{SF} , source match, and E_{RF} , reflection frequency response, are computed and stored (Figure 7-33).

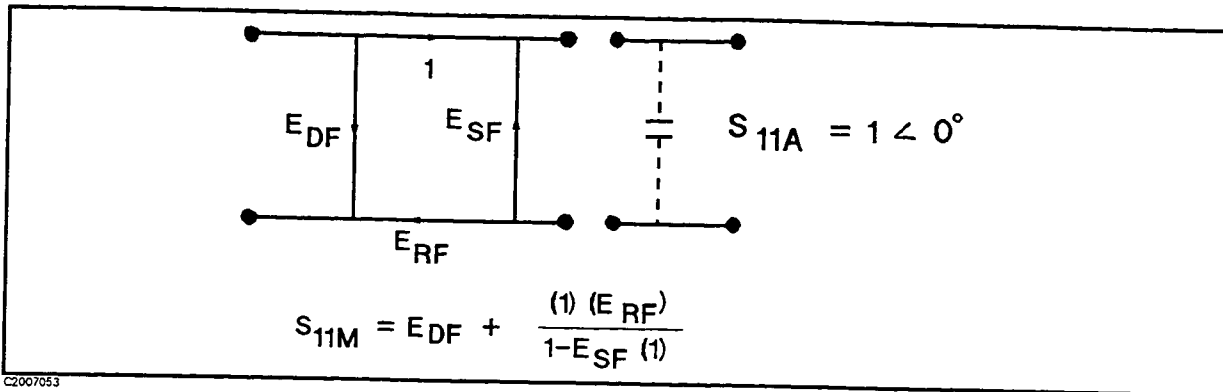

Figure 7-33. Open Circuit Termination

Now the unknown is measured to obtain a value for the measured response, S_{11M} , at each frequency (Figure 7-34).

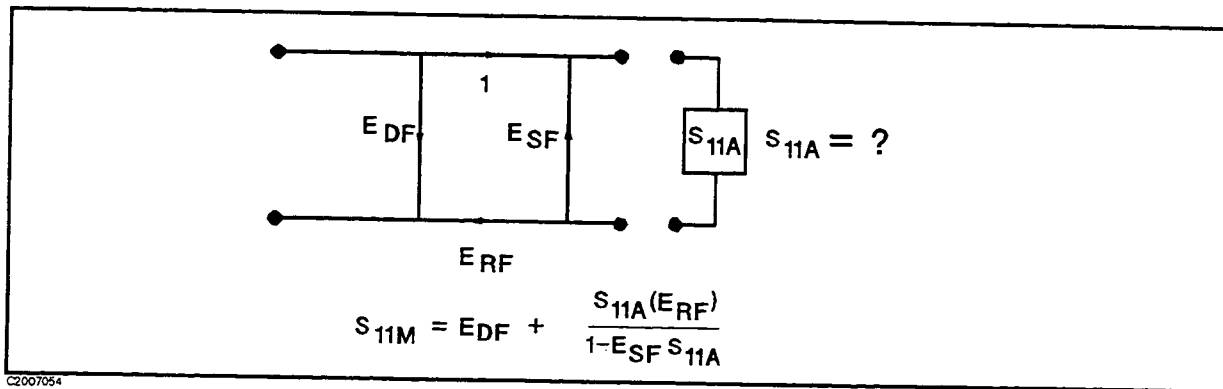

Figure 7-34. Measured S_{11}

This is the one-port error model equation solved for S_{11A} . Since the three errors and S_{11M} are now known for each test frequency, S_{11A} can be computed as follows:

$$S_{11A} = \frac{S_{11M} - E_{DF}}{E_{SF}(S_{11M} - E_{DF}) + E_{RF}}$$

For reflection measurements on two-port devices, the same technique can be applied, but the test device output port must be terminated in the system characteristic impedance. This termination should be at least as good (have as low a reflection coefficient) as the LOAD used to determine directivity. The additional reflection error caused by an improper termination at the test device output port is not incorporated into one-port error model.

Two-Port Error Model

The error model for measurement of the transmission coefficients (magnitude and phase) of a two-port device is derived in a similar manner. The major sources of error are frequency response (tracking), source match, load match, and isolation (Figure 7-35). These errors are effectively removed using the full two-port error model.

Accuracy Enhancement Fundamentals-Characterizing Systematic Errors

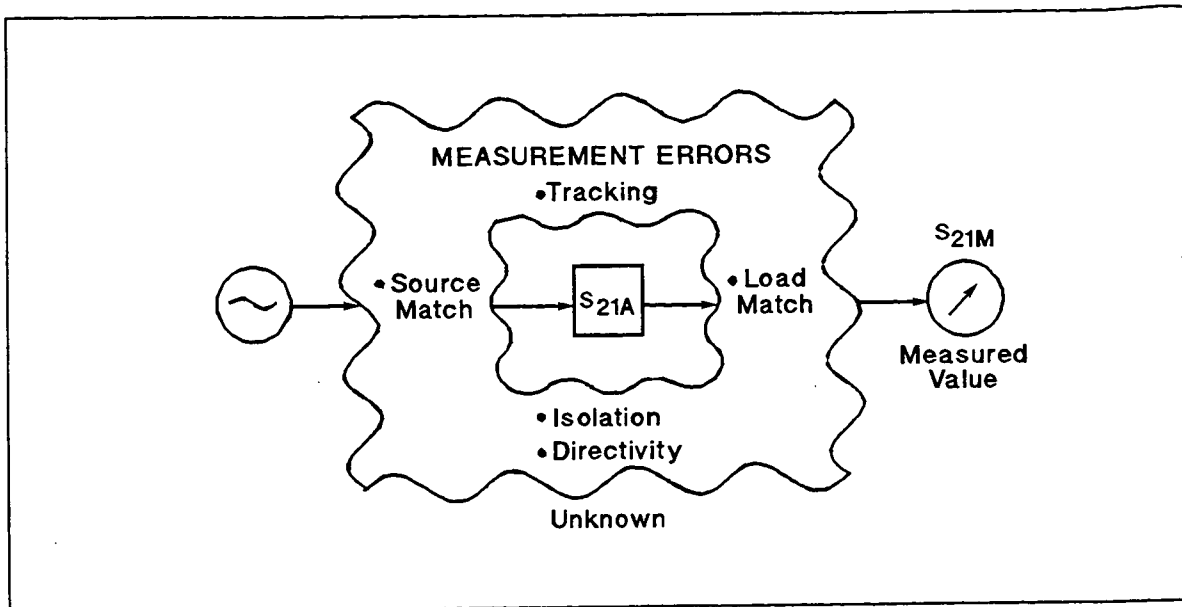

C2007055

Figure 7-35. Major Sources of Error

Measuring Transmission Coefficient. The transmission coefficient is measured by taking the ratio of the incident signal (I) and the transmitted signal (T) (Figure 7-36). Ideally, (I) consists only of power delivered by the source, and (T) consists only of power emerging at the test device output.

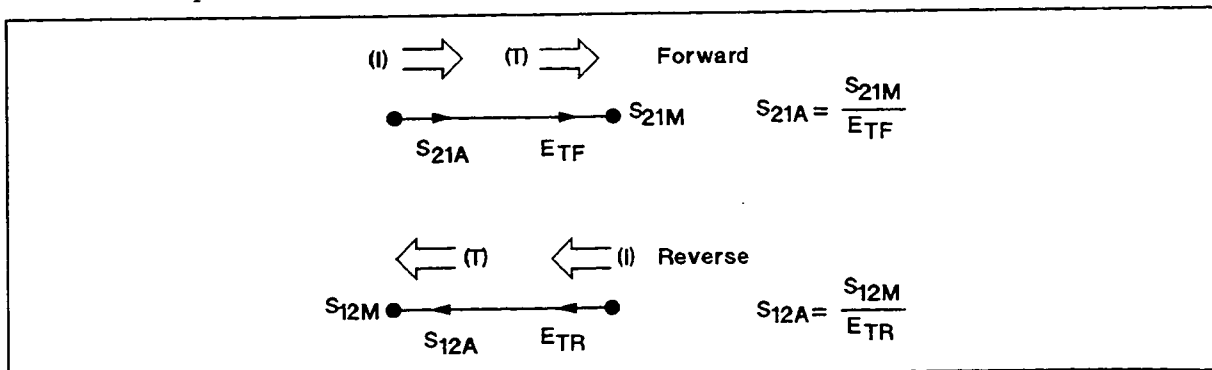

C2007056

Figure 7-36. Transmission Coefficient

Load Match Error. As in the reflection model source match can cause the incident signal to vary as a function of test device S_{11A} . Also, since the test setup transmission return port is never exactly the characteristic impedance, some of the transmitted signal is reflected from the test set port 2, and from other mismatches between the test device output and the receiver input, to return to the test device. A portion of this signal may be re-reflected at port 2, thus affecting S_{21M} , or part may be transmitted through the device in the reverse direction to appear at port 1, thus affecting S_{11M} . This error term, which causes the magnitude and phase of the transmitted signal to vary as a function of S_{22A} , is called load match, E_{LF} (Figure 7-37).

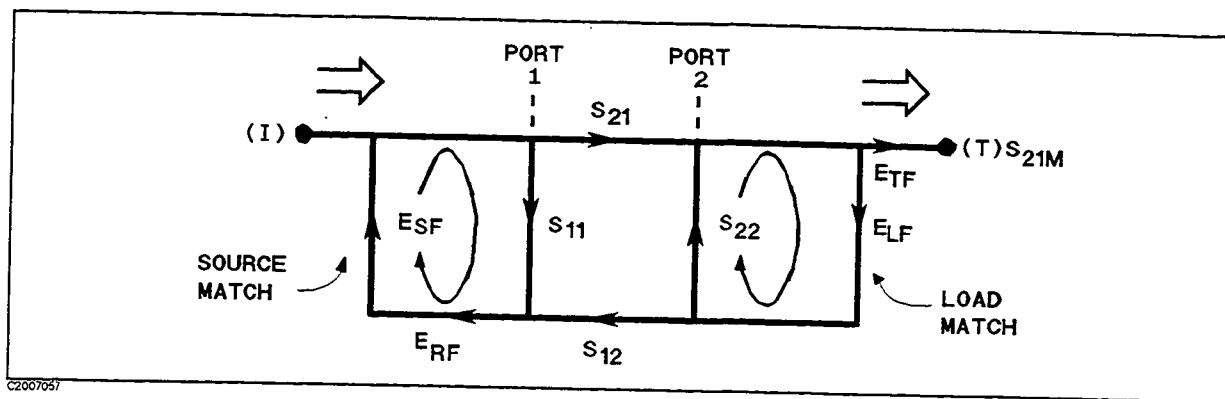

Figure 7-37. Load Match E_{LF}

The measured value, S_{21M} , consists of signal components that vary as a function of the relationship between E_{SF} and S_{11A} as well as E_{LF} and S_{22A} , so the input and output reflection coefficients of the test device must be measured and stored for use in the S_{21A} error correction computation. Thus, the test setup is calibrated as described above for the reflection to establish the directivity, E_{DF} , source match, E_{SF} , and reflection frequency response, E_{RF} , terms for the reflection measurements.

Now, that a calibrated port is available for reflection measurements, the THRU is connected and load match, E_{LF} , is determined by measuring the reflection coefficient of the THRU connection.

Transmission signal path frequency response is then measured with the THRU connected. The data is corrected for source and load match effects, then stored as transmission frequency response, E_{TF} .

Isolation Errors. Isolation, E_{XF} , represents the part of the incident signal that appears at the receiver without actually passing through the test device (Figure 7-38). Isolation is measured with the test set in the transmission configuration and with terminations installed at the points where the test device will be connected.

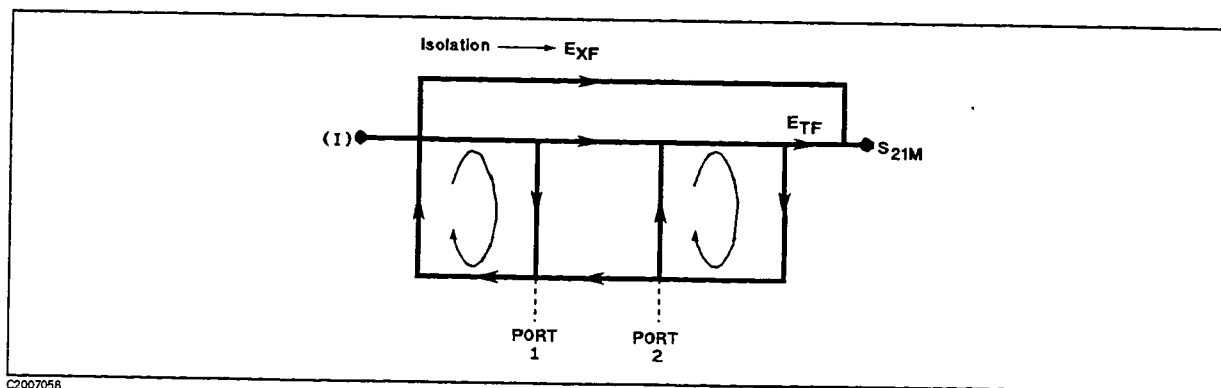

Figure 7-38. Isolation E_{XF}

Error Terms the Analyzer Can Reduce. Thus there are two sets of error terms, forward and reverse, with each set consisting of six error terms, as follows:

- Forward
 - Directivity, E_{DF}
 - Isolation, E_{XF}
 - Source Match, E_{SF}

Accuracy Enhancement Fundamentals-Characterizing Systematic Errors

- Load Match, E_{LF}
- Transmission Tracking, E_{TF}
- Reflection Tracking, E_{RF}
- Reverse
 - Directivity, E_{DR}
 - Isolation, E_{XR}
 - Source Match, E_{SR}
 - Load Match, E_{LR}
 - Transmission Tracking, E_{TR}
 - Reflection Tracking, E_{RR}

The HP 87511A, B S-parameter Test sets can measure both the forward and reverse characteristics of the test device without the need to manually remove and physically reverse it. With these test sets, the full two-port error model illustrated in Figure 7-39 effectively removes both the forward and reverse error terms for transmission and reflection measurements.

The HP 87512A, B Transmission/Reflection Test kits cannot switch between forward and reverse directions, so the reverse error terms cannot be automatically measured. Therefore, with the one-path two-port calibration, the forward error terms are duplicated and used for both forward and reverse measurements by manually reversing the test device.

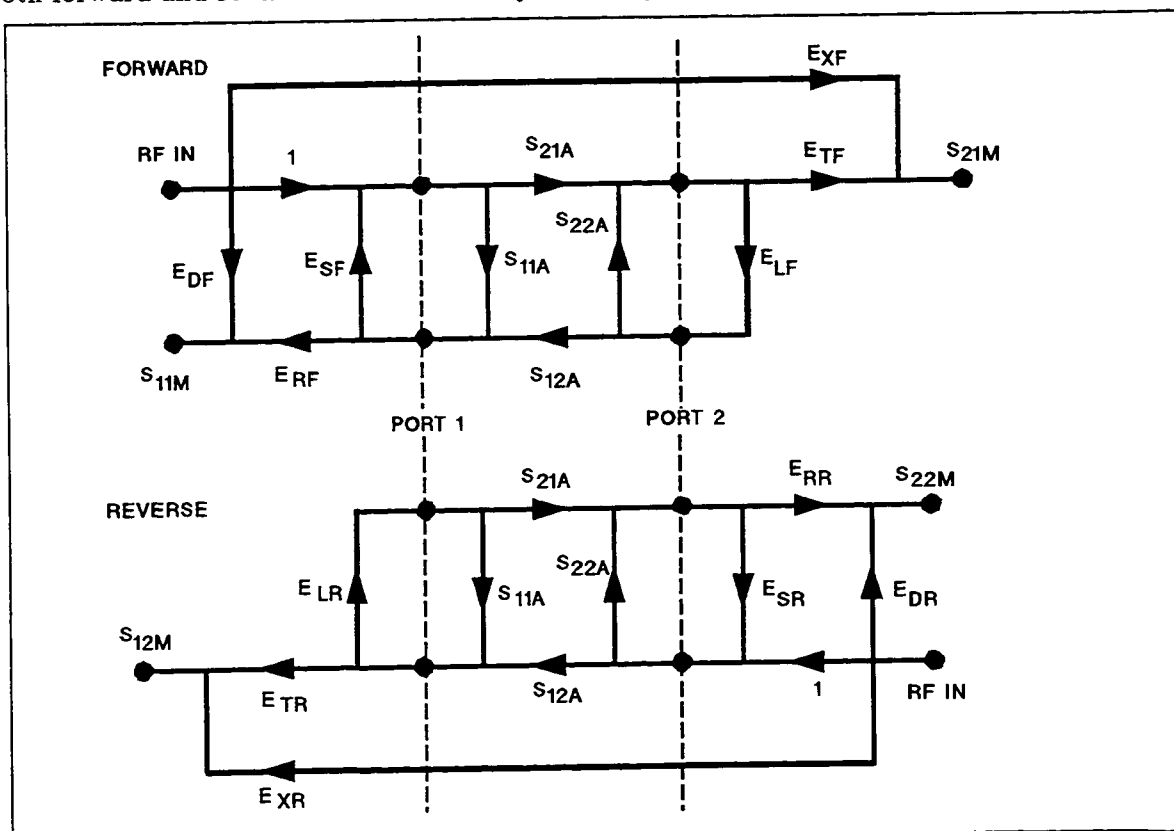

C2007059

Figure 7-39. Full Two-Port Error Model

The following equations show the full two-port error model equations for all four S-parameters of a two-port device. Note that the mathematics for this comprehensive model

Accuracy Enhancement Fundamentals-Characterizing Systematic Errors

use all forward and reverse error terms and measured values. Thus, to perform full error correction for any one parameter, all four S-parameters must be measured.

Applications of these error models are provided in the calibration procedures described in Chapter 7.

$$S_{11A} = \frac{\left[\left(\frac{S_{11M}-E_{DF}}{E_{RF}} \right) \left[1 + \left(\frac{S_{22M}-E_{DR}}{E_{RR}} \right) E_{SR} \right] - \left[\left(\frac{S_{21M}-E_{XF}}{E_{TF}} \right) \left(\frac{S_{12M}-E_{XR}}{E_{TR}} \right) E_{LF} \right] \right]}{\left[1 + \left(\frac{S_{11M}-E_{DF}}{E_{RF}} \right) E_{SF} \right] \left[1 + \left(\frac{S_{22M}-E_{DR}}{E_{RR}} \right) E_{SR} \right] - \left[\left(\frac{S_{21M}-E_{XF}}{E_{TF}} \right) \left(\frac{S_{12M}-E_{XR}}{E_{TR}} \right) E_{LF} E_{LR} \right]}$$

$$S_{21A} = \frac{\left[1 + \left(\frac{S_{22M}-E_{DR}}{E_{RR}} \right) (E_{SR} - E_{LF}) \right] \left(\frac{S_{21M}-E_{XF}}{E_{TF}} \right)}{\left[1 + \left(\frac{S_{11M}-E_{DF}}{E_{RF}} \right) E_{SF} \right] \left[1 + \left(\frac{S_{22M}-E_{DR}}{E_{RR}} \right) E_{SR} \right] - \left[\left(\frac{S_{21M}-E_{XF}}{E_{TF}} \right) \left(\frac{S_{12M}-E_{XR}}{E_{TR}} \right) E_{LF} E_{LR} \right]}$$

$$S_{12A} = \frac{\left[1 + \left(\frac{S_{11M}-E_{DF}}{E_{RF}} \right) (E_{SF} - E_{LR}) \right] \left(\frac{S_{12M}-E_{XR}}{E_{TR}} \right)}{\left[1 + \left(\frac{S_{11M}-E_{DF}}{E_{RF}} \right) E_{SF} \right] \left[1 + \left(\frac{S_{22M}-E_{DR}}{E_{RR}} \right) E_{SR} \right] - \left[\left(\frac{S_{21M}-E_{XF}}{E_{TF}} \right) \left(\frac{S_{12M}-E_{XR}}{E_{TR}} \right) E_{LF} E_{LR} \right]}$$

$$S_{22A} = \frac{\left[\left(\frac{S_{22M}-E_{DR}}{E_{RR}} \right) \left[1 + \left(\frac{S_{11M}-E_{DF}}{E_{RF}} \right) E_{SF} \right] - \left[\left(\frac{S_{21M}-E_{XF}}{E_{TF}} \right) \left(\frac{S_{12M}-E_{XR}}{E_{TR}} \right) E_{LF} \right] \right]}{\left[1 + \left(\frac{S_{11M}-E_{DF}}{E_{RF}} \right) E_{SF} \right] \left[1 + \left(\frac{S_{22M}-E_{DR}}{E_{RR}} \right) E_{SR} \right] - \left[\left(\frac{S_{21M}-E_{XF}}{E_{TF}} \right) \left(\frac{S_{12M}-E_{XR}}{E_{TR}} \right) E_{LF} E_{LR} \right]}$$

In addition to the errors removed by accuracy enhancement, other systematic errors exist due to limitations of dynamic accuracy, test set switch repeatability, and test cable stability. These, combined with random errors, also contribute to total system measurement uncertainty. Therefore, after accuracy enhancement procedures are performed, residual measurement uncertainties remain.

Using Markers

MKR KEY

The HP-IB programming command is shown in parenthesis following the key or softkey.

The **MKR** key displays a movable active marker (∇) on the screen and provides access to a series of menus to control one to eight display markers for each channel (a total of sixteen). Markers obtain numerical readings of measured values. They also provide capabilities for reducing measurement time by changing stimulus parameters, searching the trace for specific values, or statistically analyzing part or all of the trace. Figure 8-1 illustrates the displayed trace with all markers ON and marker 1 the active marker.

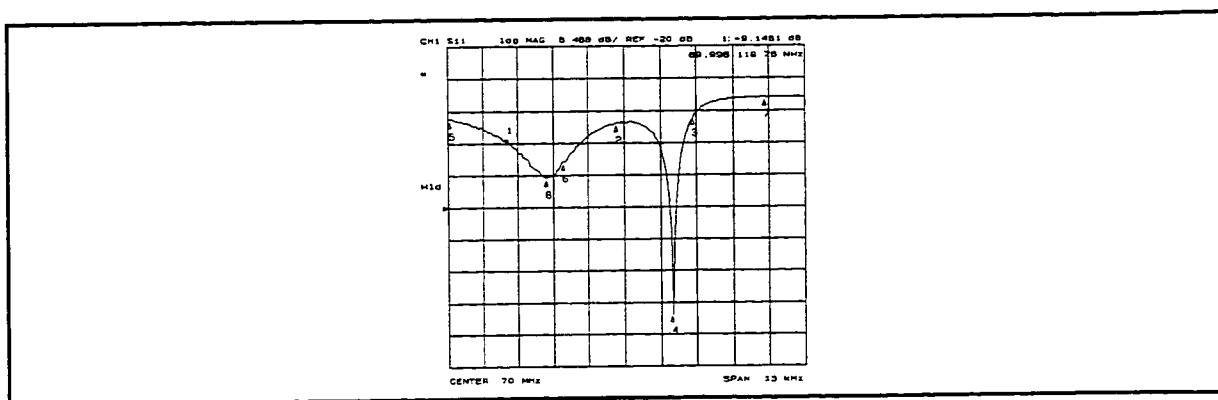

Figure 8-1. Markers on Trace

Markers have a stimulus value (the x-axis value in a Cartesian format) and a response value (the y-axis value in a Cartesian format). In a polar or Smith chart format, the second part of a complex data pair is also provided as an auxiliary response value. When a marker is turned on and no other function is active, its stimulus value is displayed in the active entry area and can be controlled with the knob, the step keys, or the numeric keypad. The active marker can be moved to any point on the trace, and its response and stimulus values are displayed at the top right corner of the graticule for each displayed channel, in units appropriate to the display format. The displayed marker response values are valid even when the measured data is above or below the range displayed on the graticule. When marker list is turned on, stimulus values and response values of all markers are listed on the graticule. When marker time mode is turned on, the x-axis is changed to the time scale, where the start point of the x-axis is 0 seconds and the stop point indicates the sweep time and markers have a time instead of a stimulus value. Marker values are normally continuous: that is, they are interpolated between measured points. Alternatively, they can be set to read only discrete measured points. The markers for the two channels normally have the same stimulus values, or they can be uncoupled so that each channel has independent markers, regardless of whether stimulus values are coupled or dual channel display is ON.

MKR Key

If both data and memory are displayed, you can select which marker values apply to the data trace or the memory trace. If one of data or memory is displayed, the marker values apply to the trace displayed. In a memory math display (data/memory or data-memory), the marker values apply to the trace resulting from the memory math function.

With the use of a reference marker, a delta marker mode is available that displays both the stimulus and response values of the active marker relative to the reference. Any of the eight markers or a fixed point can be designated as the delta reference marker. If the delta reference is one of the eight markers, its stimulus value can be controlled by the user and its response value is the value of the trace at that stimulus value. If the delta reference is a fixed marker, both its stimulus value and its response value can be set arbitrarily by the user anywhere in the display area (not necessarily on the trace). Markers can search for the trace maximum/minimum, mean point, any other point, peak maximum/minimum or peak-to-peak value of all or part of the trace. The eight markers can be used together to search for specified bandwidth cutoff points and calculate the bandwidth. Statistical analysis uses markers to provide a readout of the mean, standard deviation, and peak-to-peak values of all or part of the trace.

Basic marker operations are available in the menus accessed from the **MKR** key. The marker search and statistical functions, together with the capability for quickly changing stimulus parameters with markers, are provided in the menus accessed from the **MKR FCTN** key.

Note



The marker functions are not affected by waveform analysis command execution. For more information on the wave form analysis commands, refer to the *HP 8751A HP-IB Programming Manual*.

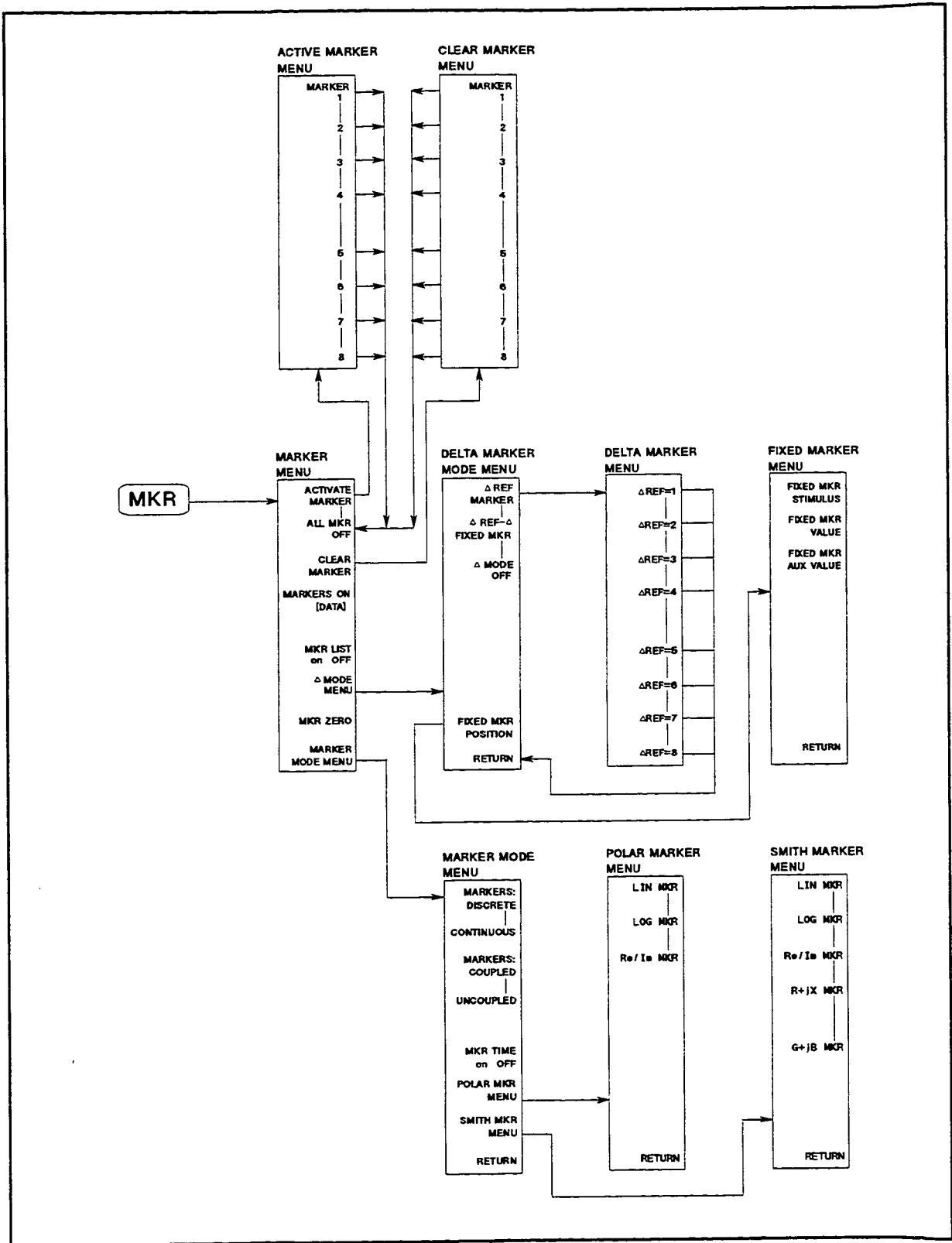

C2008017

Figure 8-2. Menus Accessed from the MKR Key

MKR Key

The menus accessed from the **MKR** key (Figure 8-2) provide several basic marker operations. These include different marker modes for different display formats, and the delta marker mode that displays marker values relative to a specified value.

MARKER MENU

The marker menu (Figure 8-3) goes to the activate marker menu or clear marker menu to turn the display markers ON or OFF, to make markers apply to data trace or memory trace, to list marker values, or to gain access to the marker delta mode and other marker modes and formats.

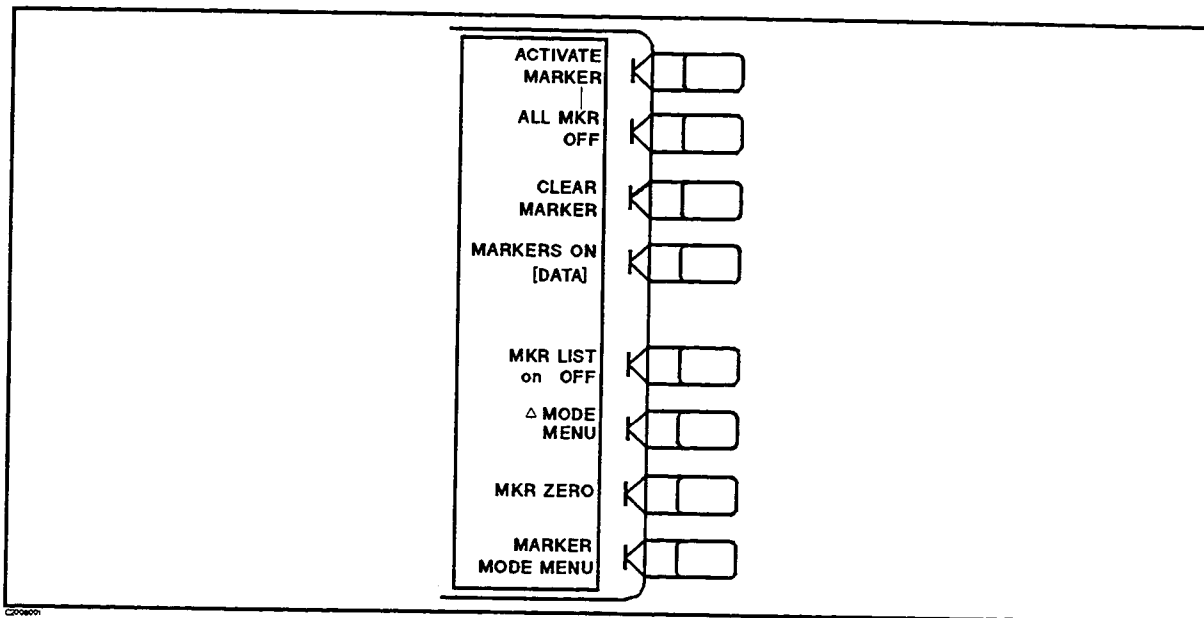

Figure 8-3. Marker Menu

ACTIVATE MARKER goes to the activate marker menu, which turns on a marker and make it the active marker.

ALL MKR OFF (MARKOFF) turns off all the markers and the delta reference marker, as well as the tracking and bandwidth functions that are accessed with the **MKR FCTN** key.

CLEAR MARKER goes to the clear marker menu, which turns off a marker.

MARKERS ON [DATA] (MARKODATA, MARKOMEMO) selects a trace from data or memory to be applied for the marker values. For the LOG MAG & PHASE or LOG MAG & DELAY formats, the data and memory trace denote LOG MAG and PHASE or DELAY, respectively.

MKR LIST on off (MARKLON, MARKLOFF) lists stimulus values and response values of all markers. In Δ mode, this lists all delta markers, and fixed markers.

Δ MODE MENU goes to the delta marker menu, which reads the difference in values between the active marker and a reference marker.

MKR ZERO (MARKZERO) puts a fixed reference marker at the present active marker position, and makes the fixed marker stimulus and response values at that position equal to zero. All subsequent stimulus and response values of the active marker are then read out relative to the fixed marker. The fixed marker is shown on the display as a small triangle "Δ" (delta), smaller than the inactive marker triangles. The softkey label changes from **MKR ZERO** to **MKR ZERO Δ REF = Δ** and the notation "ΔREF=Δ" is displayed at the top right corner of the graticule. Marker zero is canceled by turning delta mode off in the delta marker menu or turning all the markers off with the **ALL MKR OFF** softkey.

MARKER MODE MENU provides access to the marker mode menu, where several marker modes can be selected including special markers for polar and Smith chart formats.

Activate marker menu

This menu (Figure 8-4) turns the display markers on and to designate the active marker.

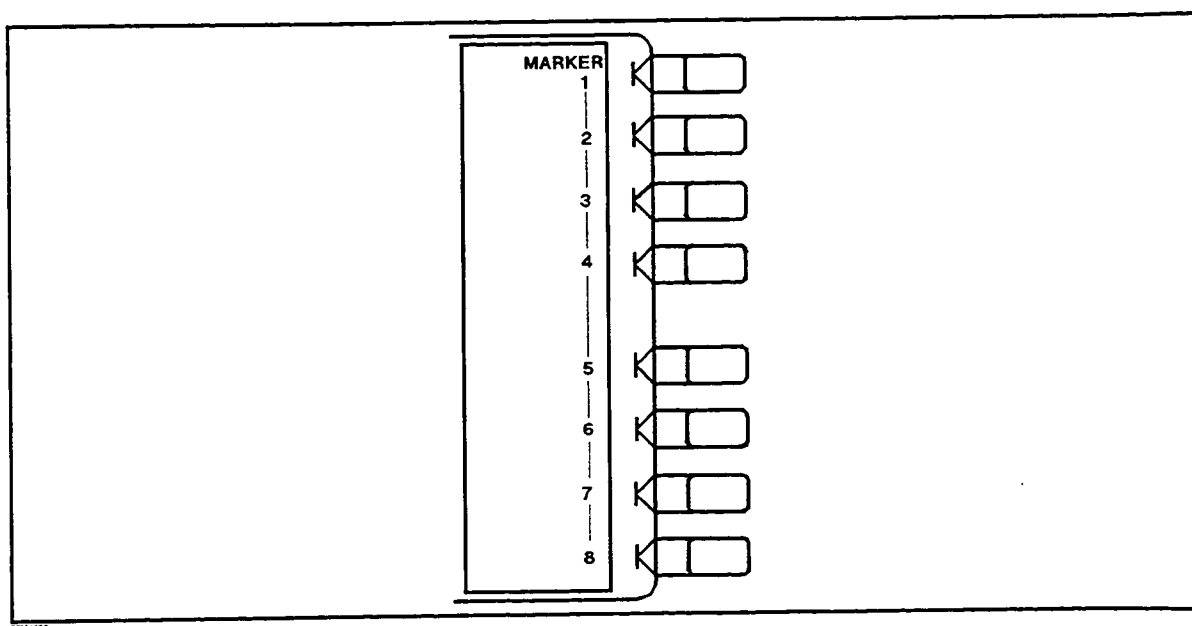

Figure 8-4. Activate Marker Menu

MARKER 1 (MARK1) turns on marker 1 and makes it the active marker. The active marker appears on the display as "▽". The active marker stimulus value is displayed in the active entry area, together with the marker number. If there is a marker turned on, and no other function is active, the stimulus value of the active marker can be controlled with the knob, the step keys, or the numeric keypad. The marker response and stimulus values are displayed in the upper right-hand corner of the screen.

MARKER 2 (MARK2) turns on marker 2 and makes it the active marker. If another marker is present, that marker becomes inactive and is represented on the display as "Δ".

MARKER 3 (MARK3) turns on marker 3 and makes it the active marker.

MARKER 4 (MARK4) turns on marker 4 and makes it the active marker.

MKR Key

MARKER 5 (MARK5) turns on marker 5 and makes it the active marker.

MARKER 6 (MARK6) turns on marker 6 and makes it the active marker.

MARKER 7 (MARK7) turns on marker 7 and makes it the active marker.

MARKER 8 (MARK8) turns on marker 8 and makes it the active marker.

Clear Marker Menu

This menu (Figure 8-5) turns the display markers OFF. If an activated marker is cleared, the marker of smallest number, if any, will be activated.

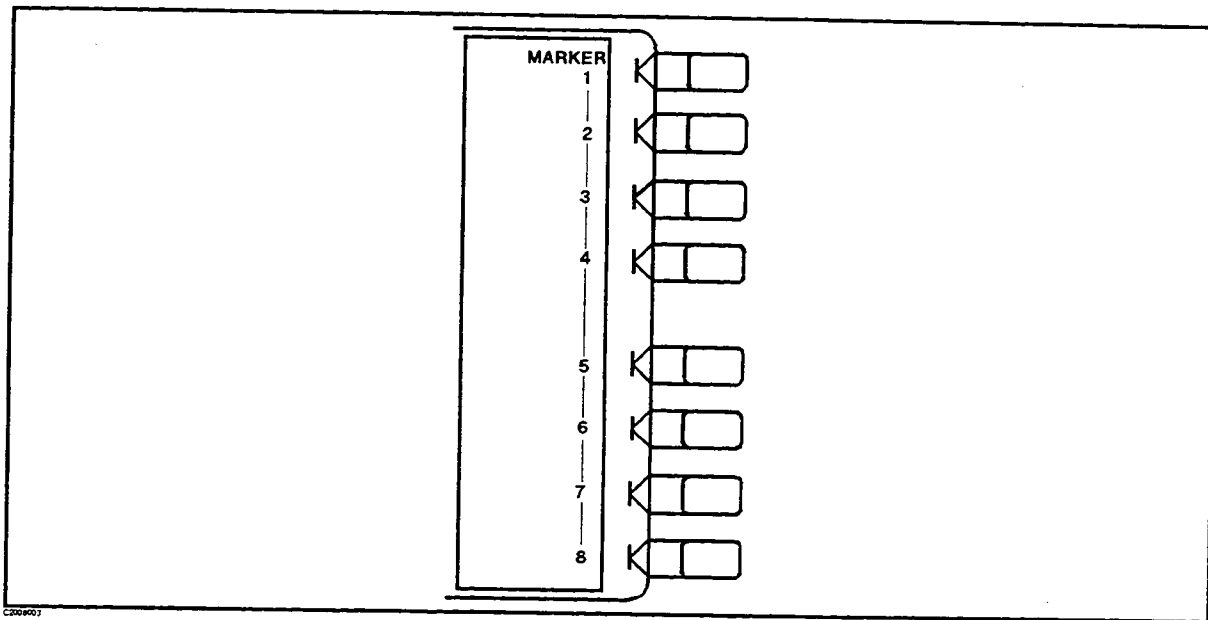

Figure 8-5. Clear Marker Menu

MARKER 1 (CLEM1) turns off marker 1.

MARKER 2 (CLEM2) turns off marker 2.

MARKER 3 (CLEM3) turns off marker 3.

MARKER 4 (CLEM4) turns off marker 4.

MARKER 5 (CLEM5) turns off marker 5.

MARKER 6 (CLEM6) turns off marker 6.

MARKER 7 (CLEM7) turns off marker 7.

MARKER 8 (CLEM8) turns off marker 8.

Delta Marker Mode Menu

The delta marker mode reads the difference in stimulus and response values between the active marker and a designated delta reference marker. Any of the eight markers or a fixed point can be designated as the reference marker. If the reference is one of the eight markers, its stimulus value can be controlled by the user and its response value is the value of the trace at that stimulus value. If the reference is a fixed marker, both its stimulus value and its response value can be set arbitrarily by the user anywhere in the display area. The delta reference is shown on the display as a small triangle Δ (delta), smaller than the inactive marker triangles (\triangle). If one of the markers is the reference, the triangle appears next to the marker number on the trace.

The marker values displayed in this mode are the stimulus and response values of the active marker minus the reference marker. If the active marker is also designated as the reference marker, the marker values are zero.

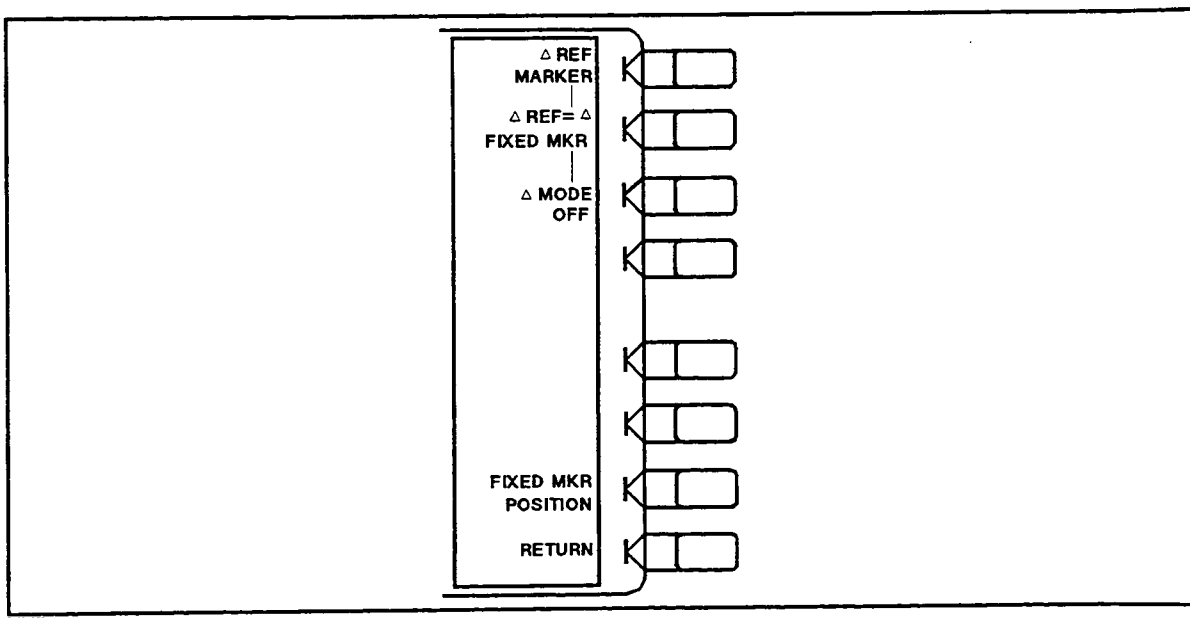

Figure 8-6. Delta Marker Mode Menu

Δ REF MARKER goes to the delta marker menu, which makes a marker the delta reference.

Δ REF= Δ FIXED MKR (DELRFIXM) sets a user-specified fixed reference marker. The stimulus and response values of the reference can be set arbitrarily, and can be anywhere in the display area. Unlike markers 1 to 8, the fixed marker need not be on the trace. The fixed marker is indicated by a small triangle Δ , and the active marker stimulus and response values are shown relative to this point. The notation " Δ REF= Δ " is displayed at the top right corner of the graticule.

Pressing this softkey turns on the fixed marker. Its stimulus and response values can then be changed using the fixed marker menu, which is accessed with the **FIXED MKR POSITION** softkey described below. Alternatively, the fixed marker can be set to the current active marker position, using the **MKR ZERO** softkey in the marker menu.

(MKR) Key

Δ MODE OFF (DELO) turns off the delta marker mode, so that the values displayed for the active marker are absolute values.

FIXED MKR POSITION leads to the fixed marker menu, where the stimulus and response values for a fixed reference marker can be set arbitrarily.

RETURN goes back to the marker menu.

Delta Marker Menu

This menu (Figure 8-7) establishes a marker as a delta reference. The active marker stimulus and response values are shown relative to this delta reference. If marker 1 has been selected as the delta reference, **Δ REF=1** is underlined in this menu, and the marker menu is returned to the screen. In the activate marker menu under **ACTIVATE MARKER**, the first key is now labeled **MARKER Δ REF = 1**. The notation "ΔREF=1" appears at the top right corner of the graticule.

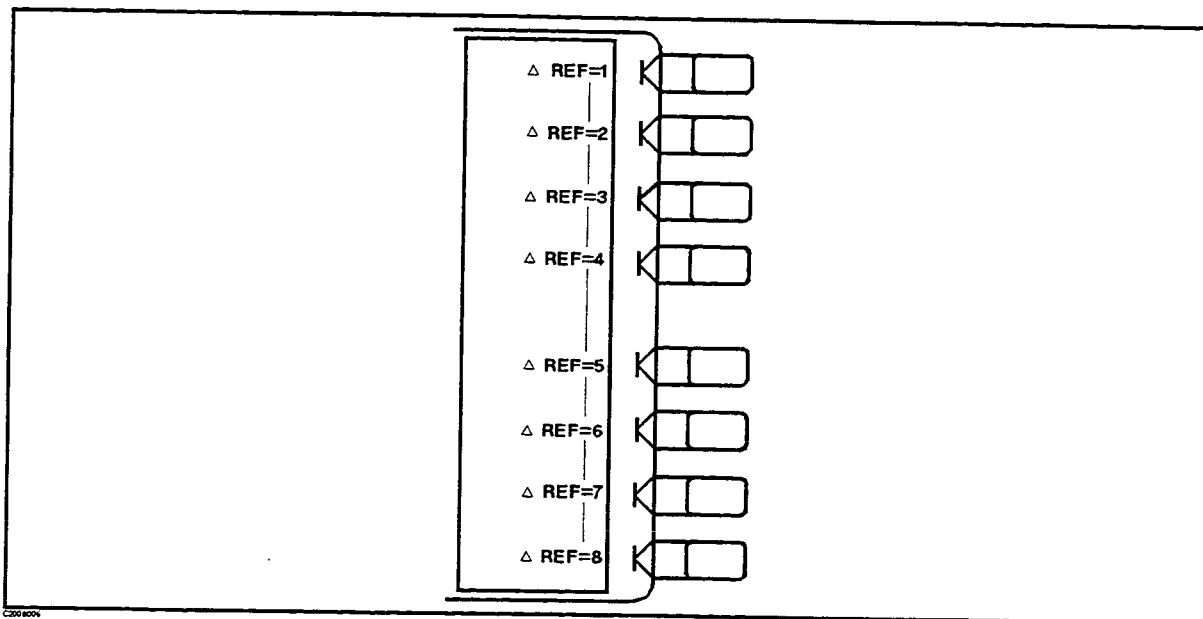

Figure 8-7. Delta Marker Menu

Δ REF = 1 (DELR1) makes marker 1 the delta reference.

Δ REF = 2 (DELR2) makes marker 2 the delta reference.

Δ REF = 3 (DELR3) makes marker 3 the delta reference.

Δ REF = 4 (DELR4) makes marker 4 the delta reference.

Δ REF = 5 (DELR5) makes marker 5 the delta reference.

Δ REF = 6 (DELR6) makes marker 6 the delta reference.

Δ REF = 7 (DELR7) makes marker 7 the delta reference.

Δ REF = 8 (DELR8) makes marker 8 the delta reference.

8-8 Using Markers

Fixed Marker Menu

This menu sets the position of a fixed reference marker, indicated on the display by a small triangle Δ . Both the stimulus value and the response value of the fixed marker can be set arbitrarily anywhere in the display area, and need not be on the trace. The units are determined by the display format, the sweep type, and the marker type.

There are two ways to turn on the fixed marker. One way is with the Δ REF = Δ FIXED MKR softkey in the delta marker mode menu. The other is with the MKR ZERO function in the marker menu, which puts a fixed reference marker at the present active marker position and makes the marker stimulus and response values at that position equal to zero.

The softkeys in this menu make the values of the fixed marker the active function. The marker readings in the top right corner of the graticule are the stimulus and response values of the active marker minus the fixed reference marker. Also displayed in the top right corner is the notation " Δ REF= Δ ".

The stimulus value, response value, and auxiliary response value (the second part of a complex data pair) can be individually examined and changed. This allows active marker readings that are relative in amplitude yet absolute in frequency, or any combination of relative/absolute readouts. Following a MKR ZERO operation, this menu can reset any of the fixed marker values to absolute zero for absolute readings of the subsequent active marker values.

If the format is changed while a fixed marker is ON, the fixed marker values become invalid. For example, if the value offset is set to 10 dB with a log magnitude format, and the format is then changed to phase, the value offset becomes 10 degrees. However, in polar, Smith, and inverse Smith chart formats, the specified values remain consistent between different marker types for those formats. Thus an R+jX marker set on a Smith chart format will retain the equivalent values if it is changed to any of the other Smith chart markers.

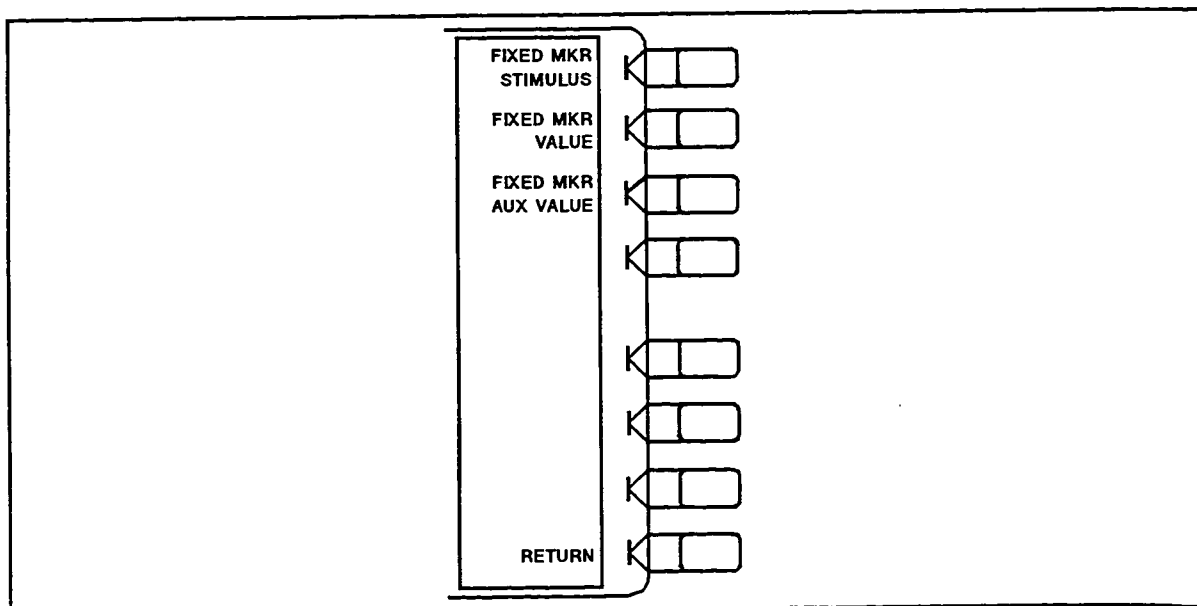

Figure 8-8. Fixed Marker Menu

MKR Key

FIXED MKR STIMULUS (MARKFSTI) changes the stimulus value of the fixed marker. Fixed marker stimulus values can be different for the two channels if the channel markers are uncoupled using the marker mode menu.

Absolute active marker stimulus values can be read, if the stimulus value is set to zero.

FIXED MKR VALUE (MARKFVAL) changes the response value of the fixed marker. In a Cartesian format this is the y-axis value. In a polar, Smith, or inverse Smith chart format with a magnitude/phase marker, a real/imaginary marker, an $R+jX$ marker, or a $G+jB$ marker, this applies to the first part (real part) of the complex data pair. Fixed marker response values are always uncoupled in the two channels.

Absolute active marker response values can be read, if the response value is set to zero.

FIXED MKR AUX VALUE (MARKFAUV) is used only with a polar, Smith, or inverse Smith format. It changes the auxiliary response value of the fixed marker. This is the second part (imaginary part) of a complex data pair, and applies to a magnitude/phase marker, a real/imaginary marker, an $R+jX$ marker, or a $G+jB$ marker. Fixed marker auxiliary response values are always uncoupled in the two channels.

Absolute active marker auxiliary response values can be read, if the auxiliary value is set to zero.

RETURN goes back to the delta marker mode menu.

Marker Mode Menu

This menu provides different marker modes and makes available two additional menus of special markers for use with a Smith chart or in polar formats.

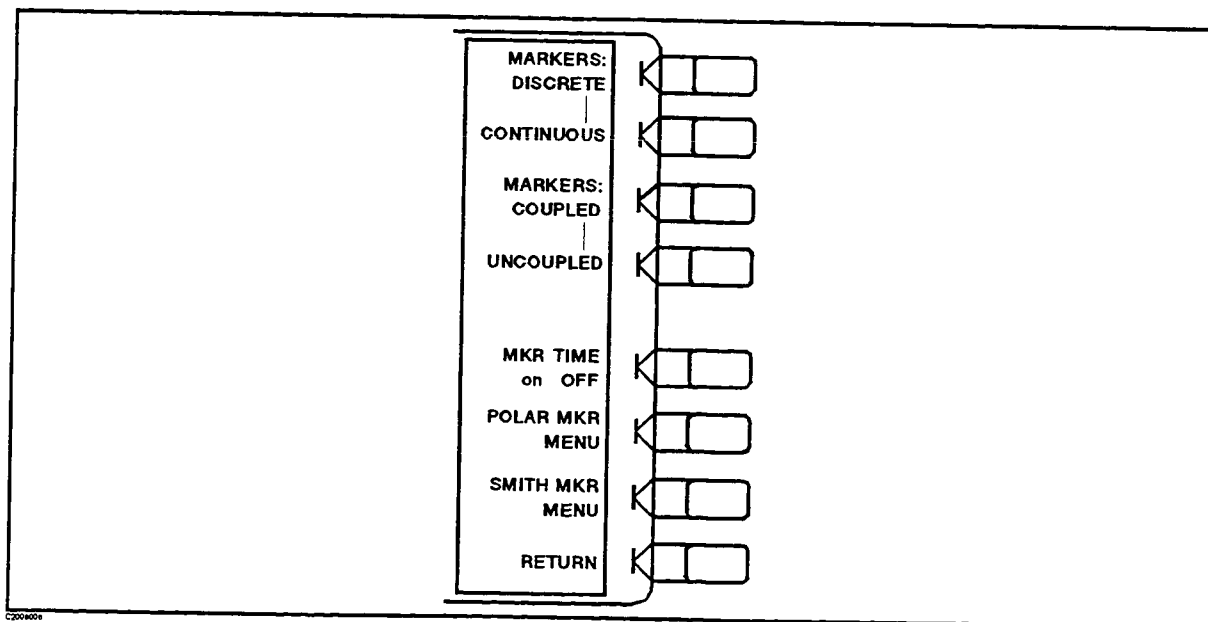

Figure 8-9. Marker Mode Menu

MARKERS: DISCRETE (MARKDISC) places markers only on measured trace points determined by the stimulus settings.

CONTINUOUS (MARKCONT) interpolates between measured points to allow the markers to be placed at any point on the trace. Displayed marker values are also interpolated. This is the default marker mode.

MARKERS: COUPLED (MARKCOUP) couples the marker stimulus values for the two display channels. Even if the stimulus is uncoupled and two sets of stimulus values are shown, the markers track the same stimulus values on each channel as long as they are within the displayed stimulus range.

UNCOUPLED (MARKUNCO) allows the marker stimulus values to be controlled independently on each channel.

MKR TIME on OFF (MARKTIMEON, MARKTIMEOFF) sets the x-axis units to time, where the start point is zero and the stop point is the value of the sweep time. A marker indicates the time passed after the sweep has started. This function is useful for testing a DUT's time transition characteristics at a certain fixed frequency by setting span to zero.

POLAR MKR MENU leads to the polar marker menu.

SMITH MKR MENU leads to the Smith marker menu.

RETURN goes back to the marker menu.

Polar Marker Menu

This menu is used only with the polar display format, selectable using the **FORMAT** key. In a polar format, the magnitude at the center of the circle is zero and the outer circle is the full scale value set in the scale reference menu. Phase is measured as the angle counterclockwise from 0° at the positive x-axis. The analyzer automatically calculates different mathematical forms of the marker magnitude and phase values, selected using the softkeys in this menu. Marker frequency is displayed in addition to other values regardless of the selection of marker type.

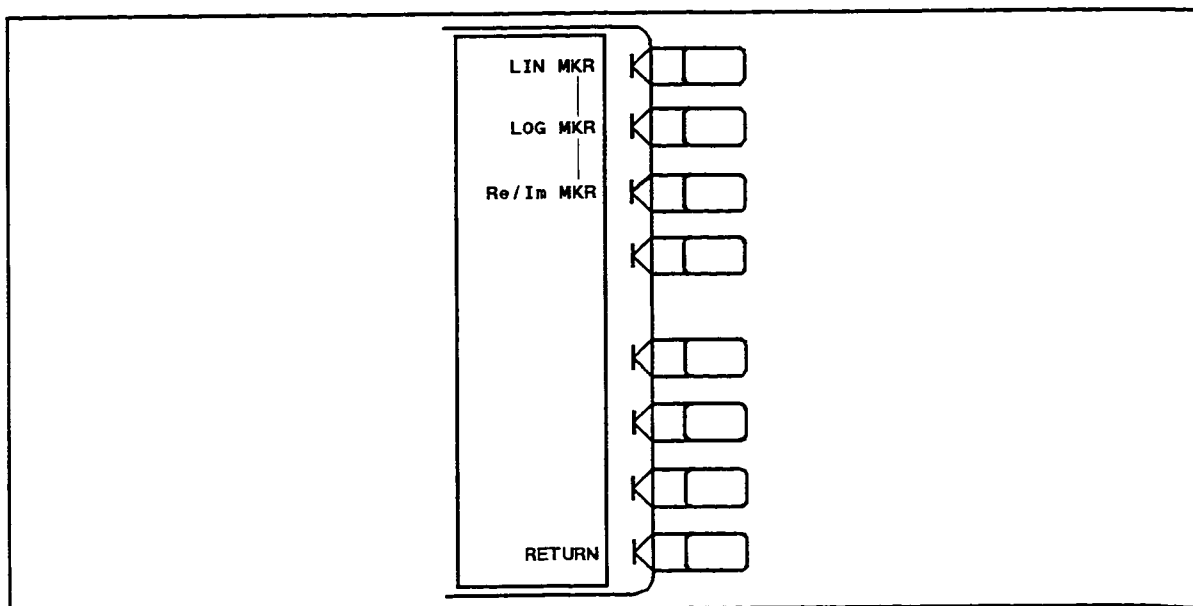

Figure 8-10. Polar Marker Menu

MKR Key

LIN MKR (POLMLIN) displays a readout of the linear magnitude and the phase of the active marker. This is the preset marker type for a polar display. Magnitude values are read in units and phase in degrees.

LOG MKR (POLMLOG) displays the logarithmic magnitude and the phase of the active marker. Magnitude values are expressed in dB and phase in degrees. This is useful as a fast method of obtaining a reading of the log magnitude value without changing to log magnitude format.

Re/Im MKR (POLMRI) displays the values of the active marker as a real and imaginary pair. The complex data is separated into its real part and imaginary part. The first marker value given is the real part ($= M \cos \theta$), and the second value is the imaginary part ($= M \sin \theta$), where M = magnitude.

RETURN goes back to the marker mode menu.

Smith Marker Menu

This menu is used only with a Smith or inverse Smith chart format, selected from the format menu. The analyzer automatically calculates different mathematical forms of the marker magnitude and phase values, selected using the softkeys in this menu. Marker frequency is displayed in addition to other values for all marker types.

For additional information about the Smith chart display format, refer to **FORMAT** Key.

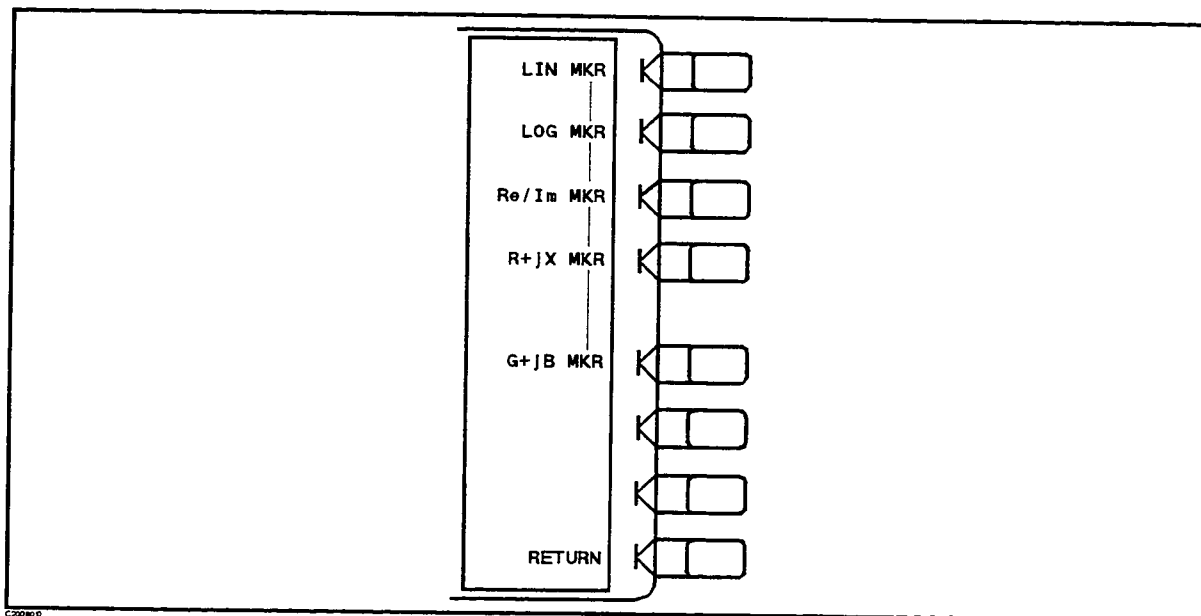

Figure 8-11. Smith Marker Menu

LIN MKR (SMIMLIN) displays a readout of the linear magnitude and the phase of the active marker. Marker magnitude values are expressed in units and phase in degrees.

LOG MKR (SMIMLOG) displays the logarithmic magnitude value and the phase of the active marker. Magnitude values are expressed in dB and phase in degrees. This is useful as a fast method of obtaining a reading of the log magnitude value without changing to log magnitude format.

Re/Im MKR (SMIMRI) displays the values of the active marker on a Smith chart as a real and imaginary pair. The complex data is separated into its real part and imaginary part. The first marker value given is the real part ($= M \cos \theta$), and the second value is the imaginary part ($= M \sin \theta$), where $M =$ magnitude.

R+jX MKR (SMIMRX) converts the active marker values into rectangular form. The complex impedance values of the active marker are displayed in terms of resistance, reactance, and equivalent capacitance or inductance. This is the default Smith chart marker.

The normalized impedance Z_0 for characteristic impedances other than 50Ω can be selected in "Calibrate More Menu" in Chapter 7.

G+jB MKR (SMIMGB) displays the complex admittance values of the active marker in rectangular form. The active marker values are displayed in terms of conductance (in Siemens), susceptance, and equivalent capacitance or inductance. Siemens are the international units of admittance, and are equivalent to mhos (the inverse of ohms).

RETURN goes back to the marker mode menu.

MKR FCTN KEY

The HP-IB programming command is shown in parenthesis following the key or softkey.

The MKR FCTN (KEY 17) key activates a marker if one is not already active, and provides access to additional marker functions. These can quickly change the measurement parameters, to search the trace for specified information, and to analyze the trace statistically.

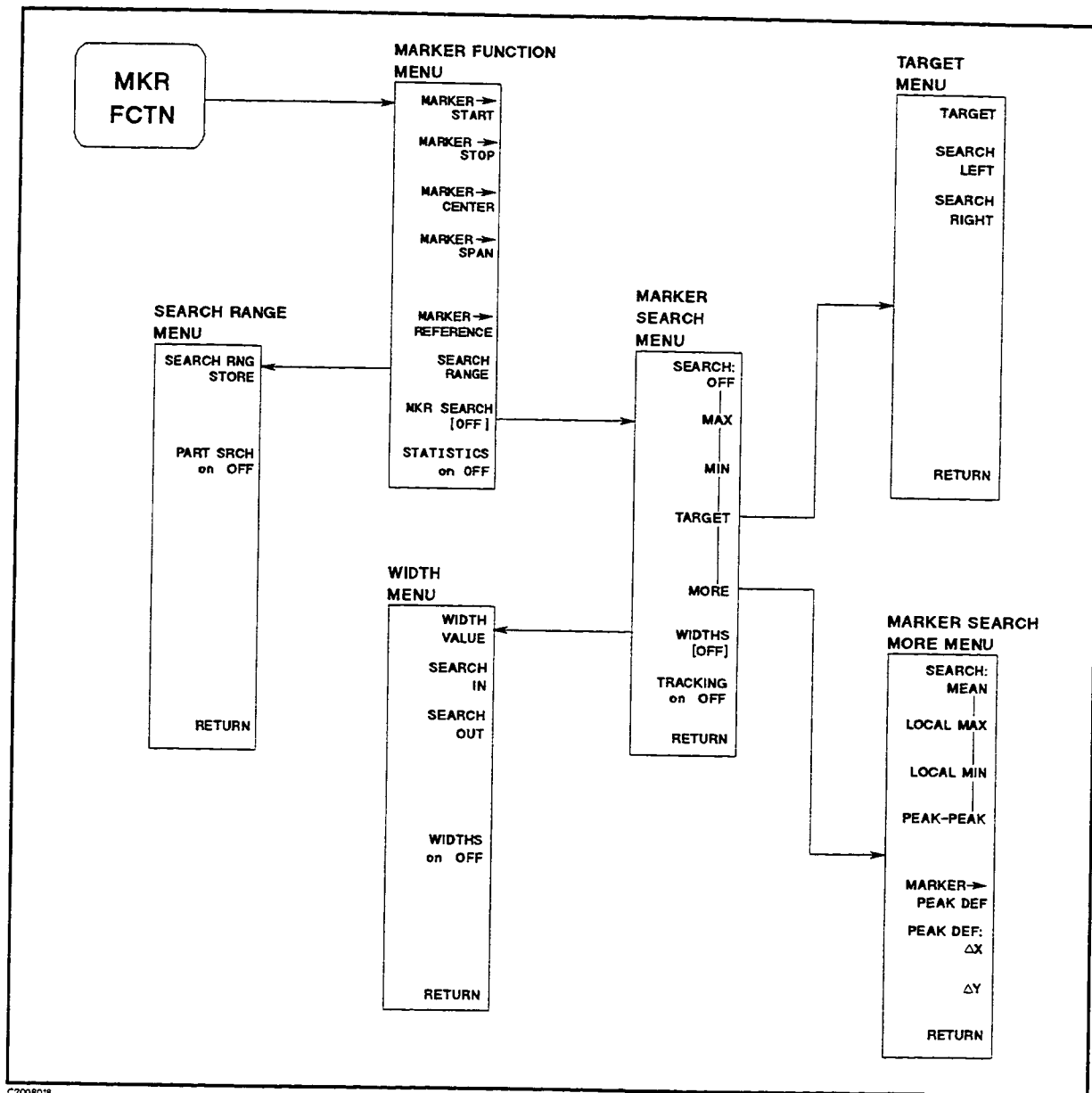

Figure 8-12. Menus Accessed from the MKR FCTN Key

Marker Function Menu

This menu provides softkeys that use markers to quickly modify certain measurement parameters without going through the usual key sequence. In addition, it provides access to five additional menus used for searching the trace, for storing the search range, and for statistical analysis.

The **MARKER →** functions change certain stimulus and response parameters to make them equal to the current active marker value. Use the knob or the numeric keypad to move the marker to the desired position on the trace, and press the appropriate softkey to set the specified parameter to that trace value. When the values have been changed, the marker can again be moved within the range of the new parameters.

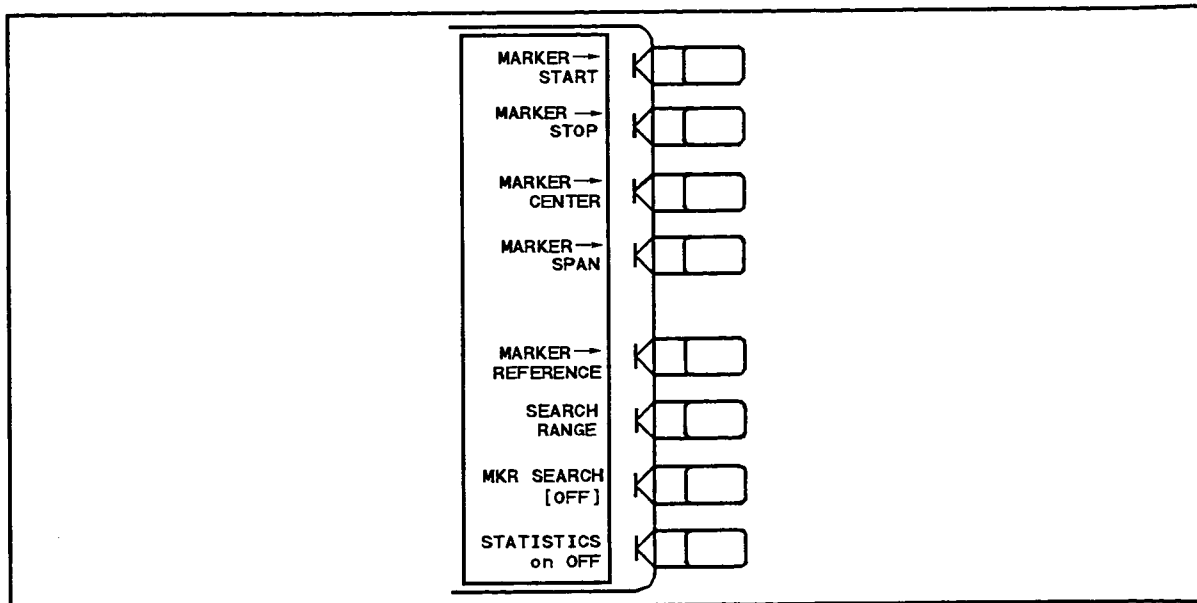

Figure 8-13. Marker Function Menu

MARKER → START (MARKSTAR) changes the stimulus start value to the stimulus value of the active marker.

MARKER → STOP (MARKSTOP) changes the stimulus stop value to the stimulus value of the active marker.

MARKER → CENTER (MARKCENT) changes the stimulus center value to the stimulus value of the active marker, and centers the new span about that value.

MARKER → SPAN (MARKSPAN) changes the start and stop values of the stimulus span to the values of the active marker and the delta reference marker. If there is no reference marker, the message "NO MARKER DELTA - SPAN NOT SET" is displayed.

MARKER → REFERENCE (MARKREF) equals the reference value to the active marker's response value, without changing the reference position. In a polar or Smith chart format, the full scale value at the outer circle is changed to the active marker response value. This softkey also appears in the scale reference menu.

MKR FCTN Key

SEARCH RANGE leads to the search range menu, which defines the range for partial search and to turn the partial search ON or OFF.

MKR SEARCH leads to the marker search menu, which searches the trace for a particular value or bandwidth.

STATISTICS (MEASTATON, MEASTATOFF) calculates and displays the mean, standard deviation, and peak-to-peak values of the section of the displayed trace in the search range defined in Search Range Menu. If Partial Search is OFF, the statistics are calculated for the entire trace. A convenient use of this feature is to find the peak-to-peak value of passband ripple without searching separately for the maximum and minimum values.

The statistics are absolute values: For polar and Smith chart formats the statistics are calculated using the first value of the complex pair (magnitude, real part, resistance, or conductance).

Search Range Menu

This menu specifies and activates the range over which the marker search functions are effective. This function is useful if a part of the entire stimulus range is analyzed.

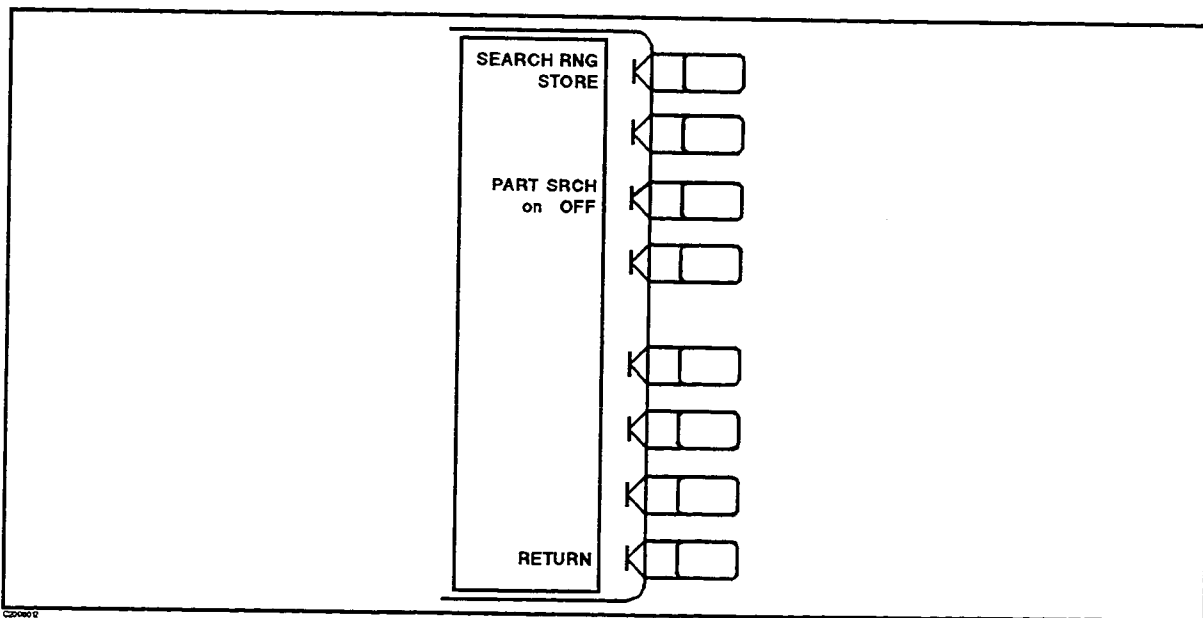

Figure 8-14. Search Range Menu

SEARCH RNG STORE (SEARSTOR) stores a search range, which is defined between the active marker and the delta reference marker. If there is no reference marker, the message "NO MARKER DELTA - RANGE NOT SET" is displayed.

PART SRCH on OFF (PARSON, PARSOFF) turns partial search ON or OFF. The search range is displayed by two small triangles, " Δ ", at the bottom of the graticule. If no search range is defined, the search range is the entire trace.

RETURN goes back to the marker function menu.

Marker Search Menu

This menu searches the trace for a specific amplitude-related point, and places the marker on that point, and to lead more menu for searching in a partial range of the trace. The capability of searching for a specified bandwidth is also provided. Tracking is available for a continuous sweep-to-sweep search. If there is no occurrence of a specified value or bandwidth, the message "TARGET VALUE NOT FOUND" is displayed.

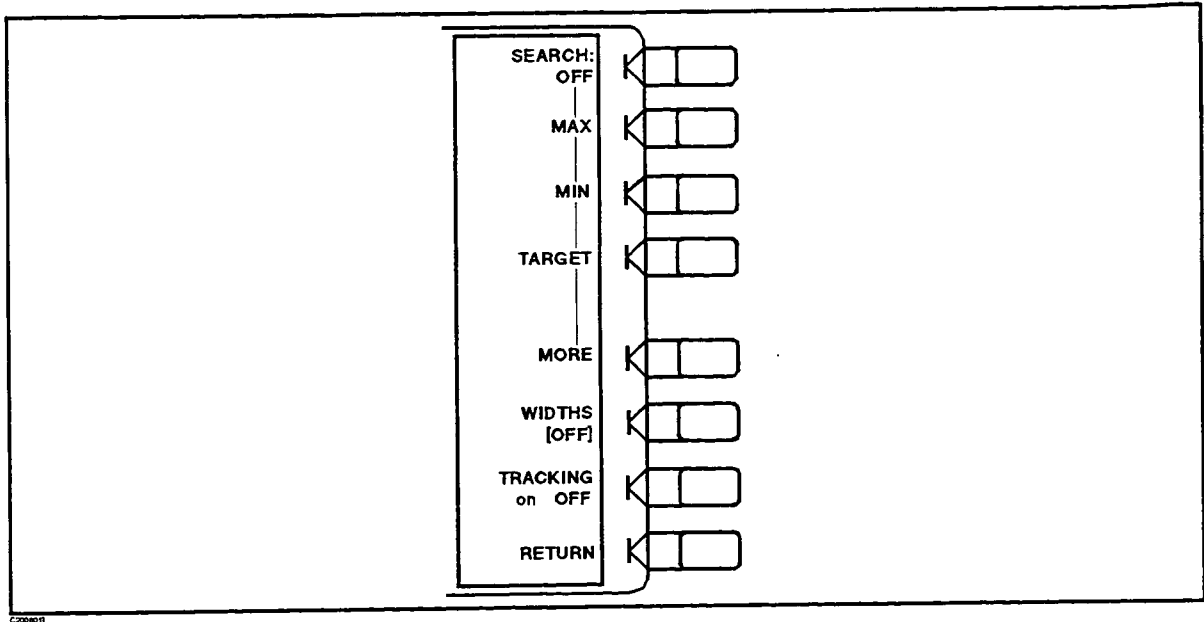

Figure 8-15. Marker Search Menu

SEARCH: OFF (SEAOFF) turns off the marker search function.

MAX (SEAMAX) moves the active marker to the maximum point on the trace. In Smith chart, inverse Smith chart, and polar format, LIN and LOG markers searches on $|\Gamma|$ and other types of marker searches on real part of measurement parameter.

MIN (SEAMIN) moves the active marker to the minimum point on the trace. In Smith chart, inverse Smith chart, and polar format, LIN and LOG markers searches on $|\Gamma|$ and other types of marker searches on real part of measurement parameter.

TARGET (SEATARG) places the active marker at a specified target point on the trace. The target menu is presented, providing search right and search left options to resolve multiple solutions.

For relative measurements, a search reference must be defined with a delta marker or a fixed marker before the search is activated.

MORE goes to the marker search more menu.

WIDTHS leads to the width menu, which is used to define the START and STOP points for a bandwidth search, and to turn bandwidth search ON and OFF.

(MKR FCTN) Key

TRACKING on OFF (TRACKON, TRACKOFF) is used in conjunction with other search features to track the search with each new sweep. Turning tracking ON makes the analyzer search every new trace for the specified target value and put the active marker on that point.

When tracking is OFF, the target is found on the current sweep and remains at the same stimulus value regardless of changes in trace response value with subsequent sweeps.

A maximum and a minimum point can be tracked simultaneously using two channels and uncoupled markers.

RETURN goes back to the marker function menu.

Target Menu

The target menu places the marker at a specified target response value on the trace, and provides search right and search left options. If there is no occurrence of the specified value, the message "TARGET VALUE NOT FOUND" is displayed.

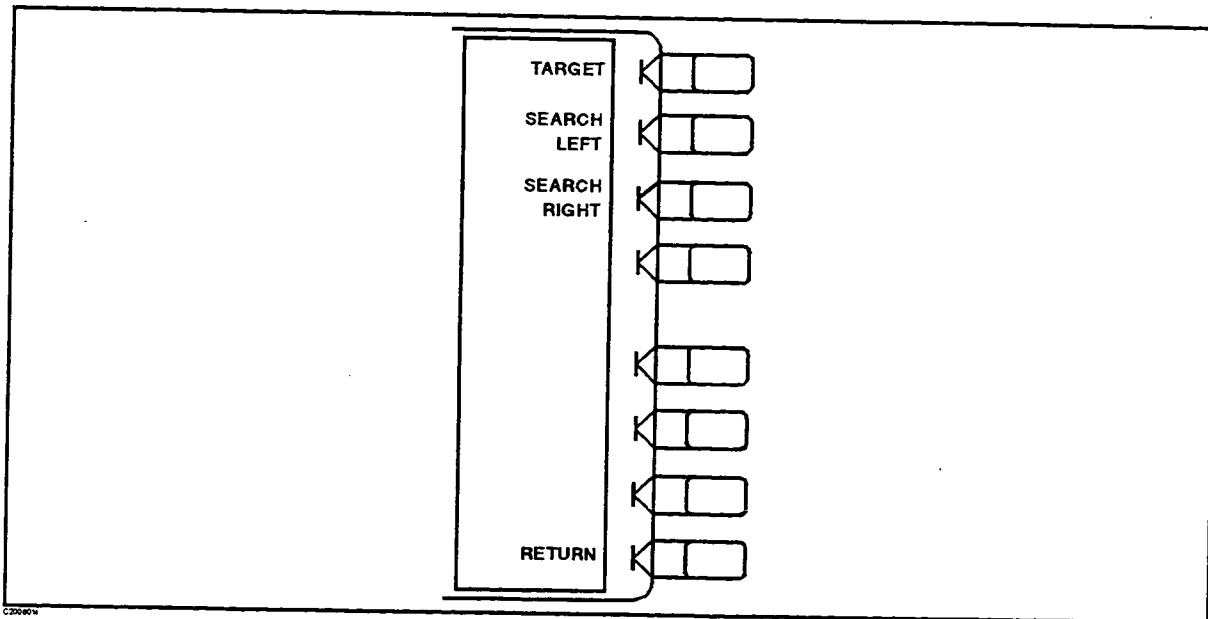

Figure 8-16. Target Menu

TARGET (SEATARG) places the marker at the specified target response value. If tracking is ON (see previous menu) the target is automatically tracked with each new trace. If tracking is OFF, the target is found each time this key is pressed. The target value is in units appropriate to the current format. The default target value is -3 dB.

In delta marker mode, the target value is the value relative to the reference marker. If no delta reference marker is ON, the target value is an absolute value.

SEARCH LEFT (SEAL) searches the trace for the next occurrence of the target value to the left.

SEARCH RIGHT (SEAR) searches the trace for the next occurrence of the target value to the right.

RETURN goes back to the marker search menu.

Marker Search More Menu

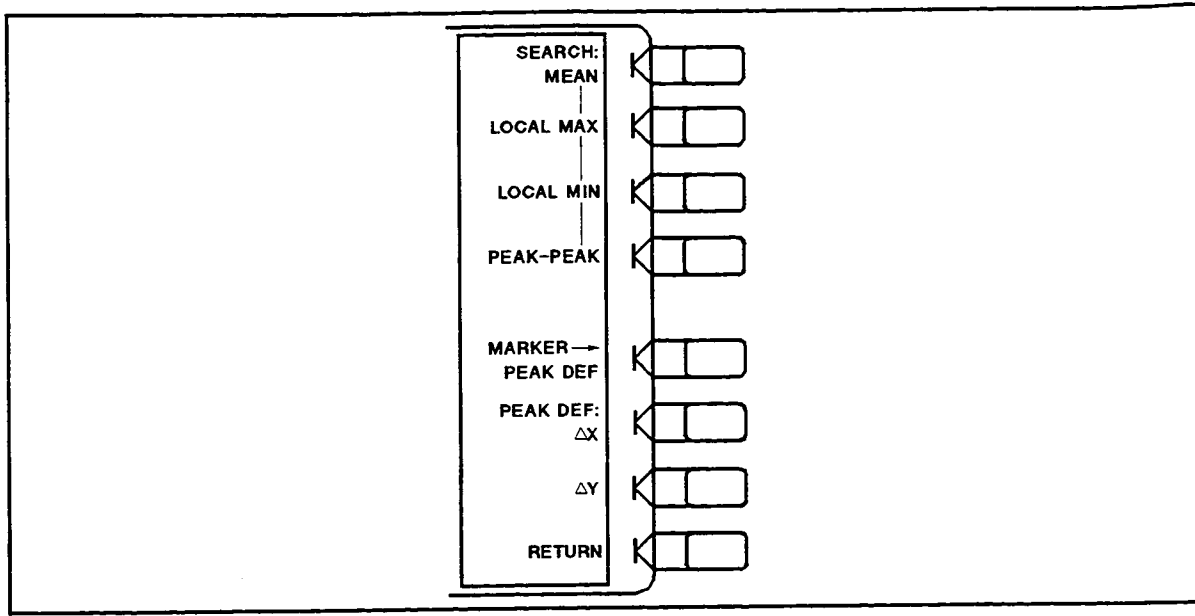

Figure 8-17. Marker Search More Menu

SEARCH: MEAN (SEAMEAN) moves the active marker to the mean point on the trace (in the search range if it has been specified).

LOCAL MAX (SEALMAX) moves the active marker to the maximum *peak* point on the trace in the search range stored in the search range menu. The applicable peak profile is defined by the **MARKER → PEAK DEF** or **PEAK DEF: ΔX** and **ΔY** keys described below.

LOCAL MIN (SEALMIN) moves the active marker to the minimum *peak* point on the trace in the search range stored in the search range menu. The applicable peak profile is defined by the **MARKER → PEAK DEF** or **PEAK DEF: ΔX** and **ΔY** keys described below.

PEAK-PEAK (SEAPPEAK) moves the active marker and the delta reference marker to the maximum peak point and the minimum peak point on the trace in the search range. The applicable peak profile is defined by the **MARKER → PEAK DEF** or **PEAK DEF: ΔX** and **ΔY** keys described below. This turns on the delta mode regardless of the current marker mode.

MARKER → PEAK DEF (MARKPEAD) changes the differential stimulus value (ΔX) and response value (ΔY) of the peak for searching for the local max, min, and peak-to-peak to the respective differential values between active and reference markers.

PEAK DEF: ΔX (PEADX) defines the differential stimulus value (ΔX) of the peak for searching for the local max, min, and peak-to-peak.

ΔY (PEADY) defines the differential response value (ΔY) of the peak for searching for the local max, min, and peak-to-peak.

Note For Peak Define

The **PEAK DEF: ΔX** and **ΔY** softkeys define the peak profile to be applicable for the **LOCAL MAX**, **LOCAL MIN**, and **PEAK-PEAK** functions. These functions search a peak where, the positive-going shoulder gradient is greater than $\Delta Y/\Delta X$, and the negative-going shoulder gradient is less than $-\Delta Y/\Delta X$. Therefore, the peak define function can limit the applicable peak to certain sharpness regardless its absolute value. The greater $\Delta Y/\Delta X$, the sharper the peak.

Example: To analyze a spurious peak on a trace, shown in Figure 8-18, using the **LOCAL MAX** softkey, specify $\Delta Y/\Delta X$, larger than that of the fundamental peak $\Delta Y_1/\Delta X_1$, (expected not to be detected) and smaller than that of the spurious peak $\Delta Y_2/\Delta X_2$ (expected to detect). This filters out the fundamental peak from the search.

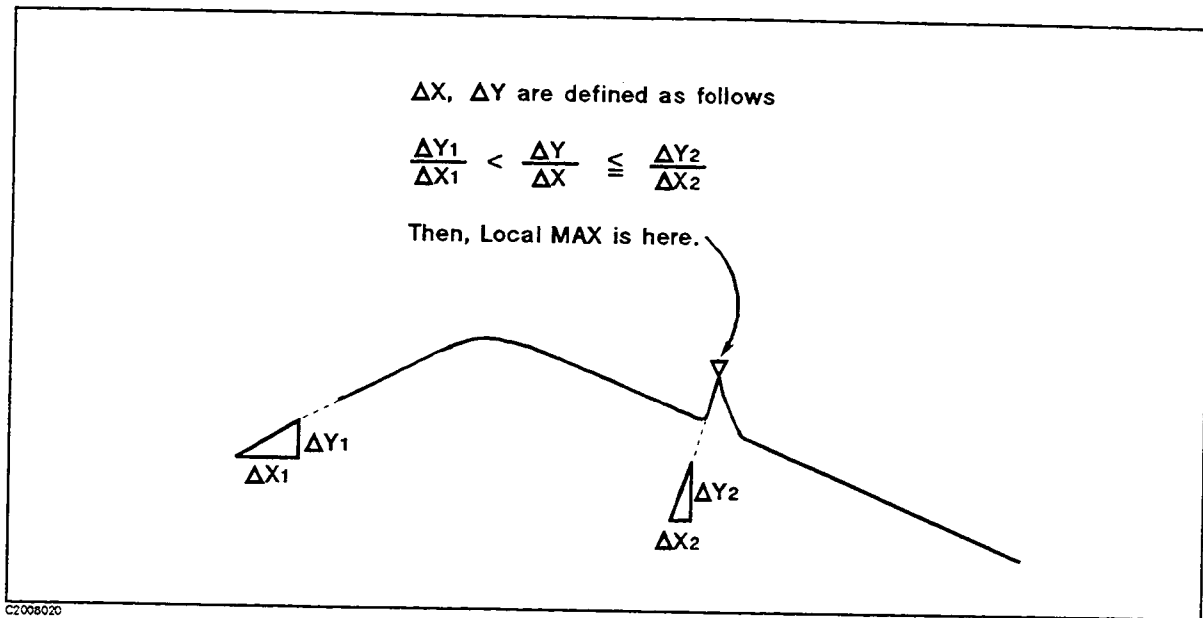

Figure 8-18. Peak Definition Example

The applicable peak is only specified by the ratio, $\Delta x/\Delta y$. The absolute values of Δx and Δy do not matter.

RETURN goes back to the marker search menu.

Width Menu

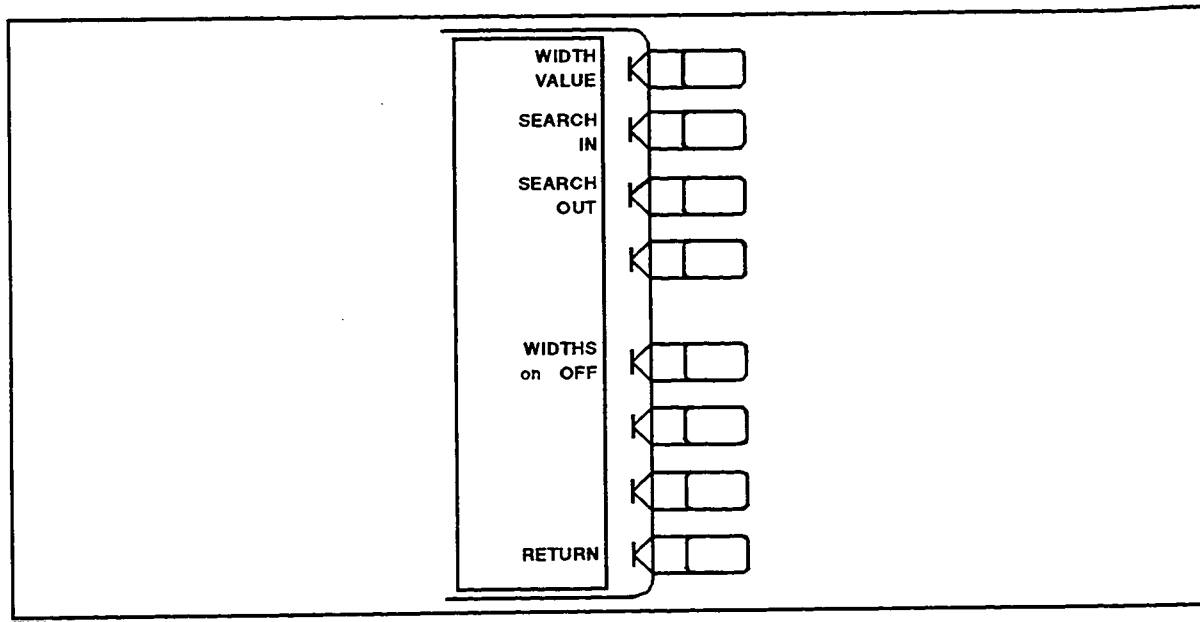

Figure 8-19. Width Menu

WIDTH VALUE (WIDV) sets the amplitude parameter (for example -3 dB) that defines the start and stop points for a bandwidth search. The bandwidth search feature analyzes a bandpass or band reject trace and calculates the center point, bandwidth, and Q (quality factor) for the specified bandwidth. Bandwidth units are in the units of the current format. When Δ mode is ON, the bandwidth value specified is the deference from the delta reference.

SEARCH IN (WIDSIN) searches for the cutoff point on the trace within the current cutoff points.

SEARCH OUT (WIDSON) searches for the cutoff point on the trace outside of the current cutoff points.

WIDTHS on OFF (WIDTON, WIDTOFF) turns on the bandwidth search feature and calculates the center stimulus value, bandwidth, Q, insertion loss, and cutoff point deviation from the center of a bandpass or band reject shape on the trace. The amplitude value that defines the passband or rejectband is set using the **WIDTH VALUE** softkey.

When **WIDTHS** is turned on, if the active marker is 1, 2, 3, or 4, markers 1, 2, 3, and 4 are turned on, and each is assigned to a dedicated use. Marker 1 is the starting point from which the search is begun. Marker 2 is the bandwidth center point. Marker 3 is the bandwidth cutoff point on the left, and marker 4 is the cutoff point on the right. If the active marker is the 5, 6, 7, or 8, markers 5, 6, 7, and 8 move in the same manner as above for markers 1, 2, 3, and 4.

The width parameters obtained are also listed on the display as follows:

BW displays the bandwidth value set by the **WIDTH VALUE** softkey.
cent displays the center stimulus value between cutoff points, which is marked by the marker 2 (, or 6).

(MKR FCTN) Key

- Q displays the Q value ($= \text{cent}/\text{BW}$) of the trace.
- Insertion Loss displays the absolute value of the marker 1 (, or 5).
- ΔF (left) displays the stimulus value difference between markers 3 (or 5) and center frequency specified by the **(CENTER)** key.
- ΔF (right) displays the stimulus value difference between markers 4 (or 8) and center frequency specified by the **(CENTER)** key.

Figure 8-20 shows an example of the bandwidth search feature.

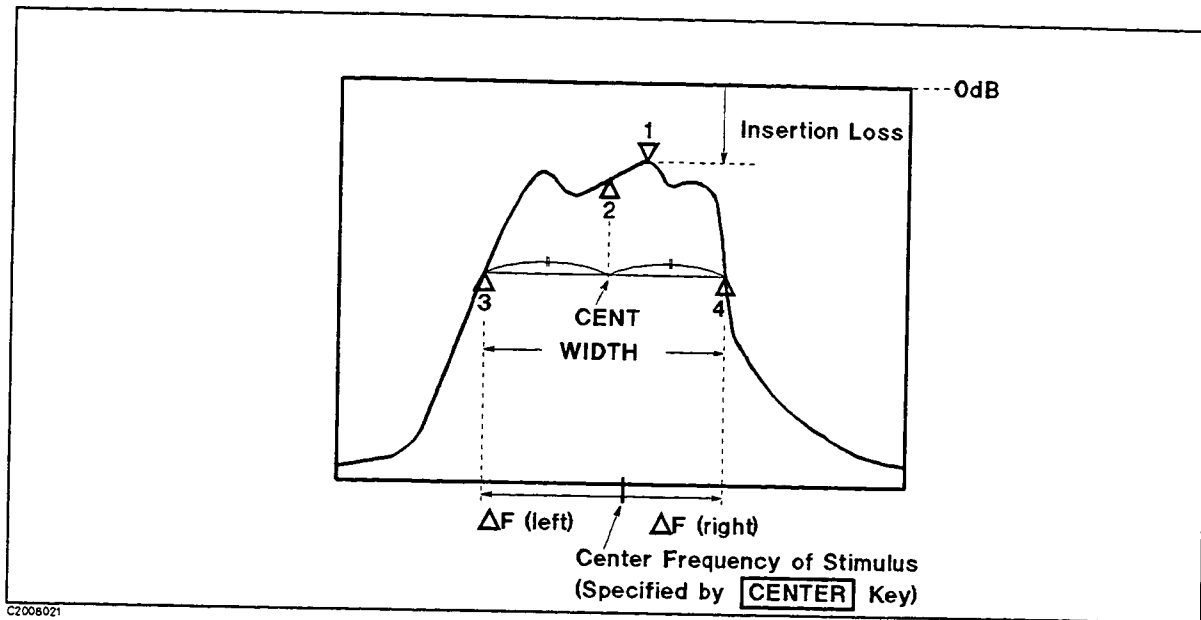

Figure 8-20. Bandwidth Search Example

If a delta marker or fixed marker is ON, it is used as the reference point from which the bandwidth amplitude is measured. For example, if marker 1 is the delta marker and is set at the passband maximum, and the width value is set to -3 dB, the bandwidth search finds the bandwidth cutoff points 3 dB below the maximum and calculates the 3 dB bandwidth and Q.

If marker 2 (the dedicated bandwidth center point marker) is the delta reference marker, the search finds the points 3 dB down from the center.

If no delta reference marker is set, the bandwidth values are absolute values.

In the expanded phase mode, this function searches the two cutoff points whose values are “+WIDTH VALUE”, and “-WIDTH VALUE”. For example, when the width value is 45° , the cutoff points' values are $\pm 45^\circ$.

RETURN goes back to the marker search menu.

Instrument State Function Block

INTRODUCTION

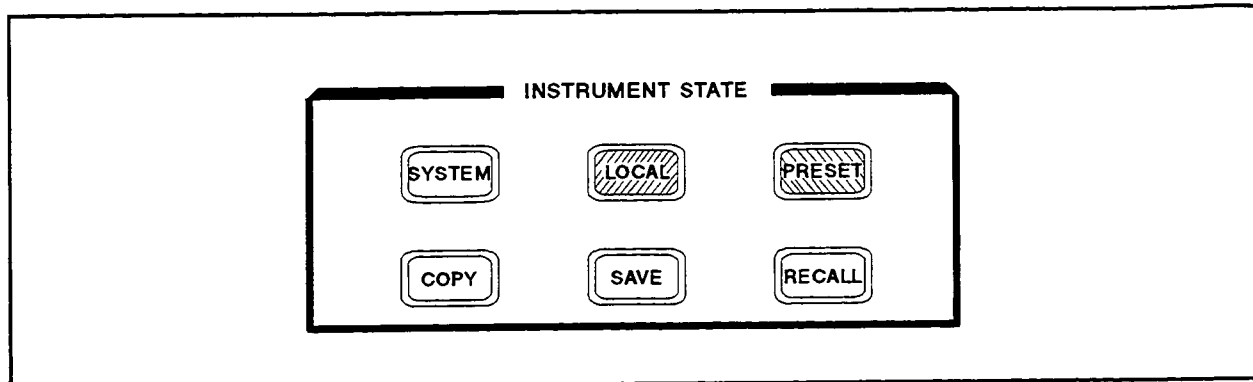

C2009001

Figure 9-1. Instrument State Function Block

The instrument state function block keys and associated menus provide control of channel-independent system functions. These include controller modes, instrument addresses, real time clock, limit lines and limit testing, Instrument BASIC (Option 002), plotting or printing, saving instrument states and trace data on a built-in disk.

INSTRUMENT STATE FUNCTIONS AND WHERE THEY ARE DESCRIBED

Functions accessible in the instrument state function block are described in several different chapters of this Reference, and in other manuals.

Table 9-1 lists each function and where it is discussed. Unless otherwise noted, all references are in this Reference and are marked with the acronym "REF".

Table 9-1. Instrument State Function Descriptions

Instrument State Key	Function	Chapter or Manual
(SYSTEM)	Instrument BASIC Clock Limit Lines and Limit Testing Service Menu	<i>HP Instrument BASIC Manual Set</i> Using HP Instrument BASIC with the HP 8751A This Chapter This Chapter <i>Maintenance Manual</i>
(COPY)	All Features - including printing and plotting	Chapter 10, REF
(SAVE)	All Features - including saving instrument states and saving to built-in disk.	Chapter 11, REF
(RECALL)	All Features - including recall of instrument state and data from built-in disk drive.	Chapter 11, REF
(LOCAL)	All features - including HP-IB and address menus.	This Chapter
(PRESET)	Preset State	Appendix A, REF

LOCAL Key

LOCAL key leads to the following menus:

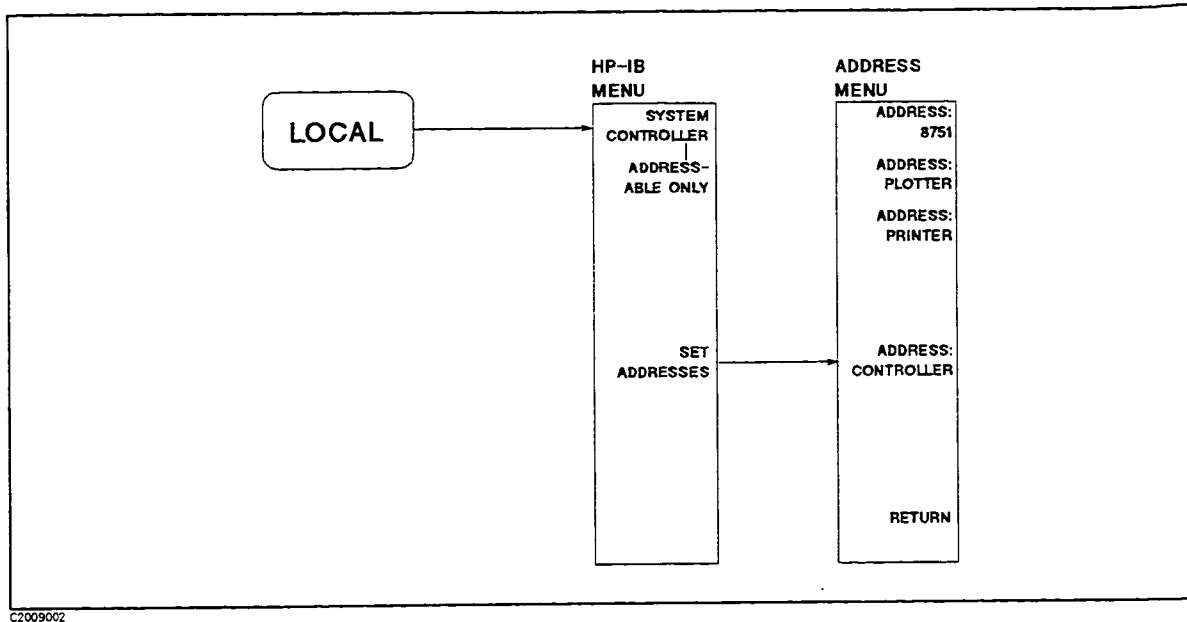

Figure 9-2. Softkey Menus Accessed from the LOCAL Key

This key performs the following functions:

- Returns front panel control to the user. The instrument ignores all front panel keys (except the local key) when under the control of an external computer. The instrument is in “local mode” when the user has front panel control. The instrument is in the “remote mode” when an external computer controls the instrument.
- Gives access to the HP-IB menu, which sets the controller mode, and to the address menu, where the HP-IB addresses of peripheral devices are entered. The controller mode determines which device controls the HP-IB bus, the instrument or computer. Only one of them can control the bus at a time.

Local Lockout

Local lockout is a remote (computer generated) command that disables the LOCAL key, making it impossible to interfere with the instrument (except for the Power Switch) while it is under computer control.

HP-IB Menu

The analyzer is factory-equipped with a remote programming interface using the Hewlett-Packard Interface Bus (HP-IB). This enables communication between the analyzer and a controlling computer as well as other peripheral devices. This menu indicates the present HP-IB controller mode of the analyzer. Two HP-IB modes are possible: system controller and addressable only.

Preset and cycling the power does not affect the selected controller mode.

9 Instrument State Block

LOCAL Key

Information on usable peripherals is provided in the *General Information* section of this manual.

System Controller Mode

In the system controller mode, the analyzer itself can use HP-IB to control usable peripherals, without the use of an external computer. For example, the analyzer can output measurement results directly to a usable printer or plotter.

Addressable Mode

This is the mode of operation most often used. In this mode, a computer can take control to communicate with the analyzer and other peripherals on the bus. The computer can send commands or instructions to and receive data from the analyzer. All of the capabilities available from the analyzer front panel can be used in this operation mode. Exceptions are some special functions such as internal tests.

Information on HP-IB operation is provided in Chapter 12 and in the *HP-IB Programming Manual*.

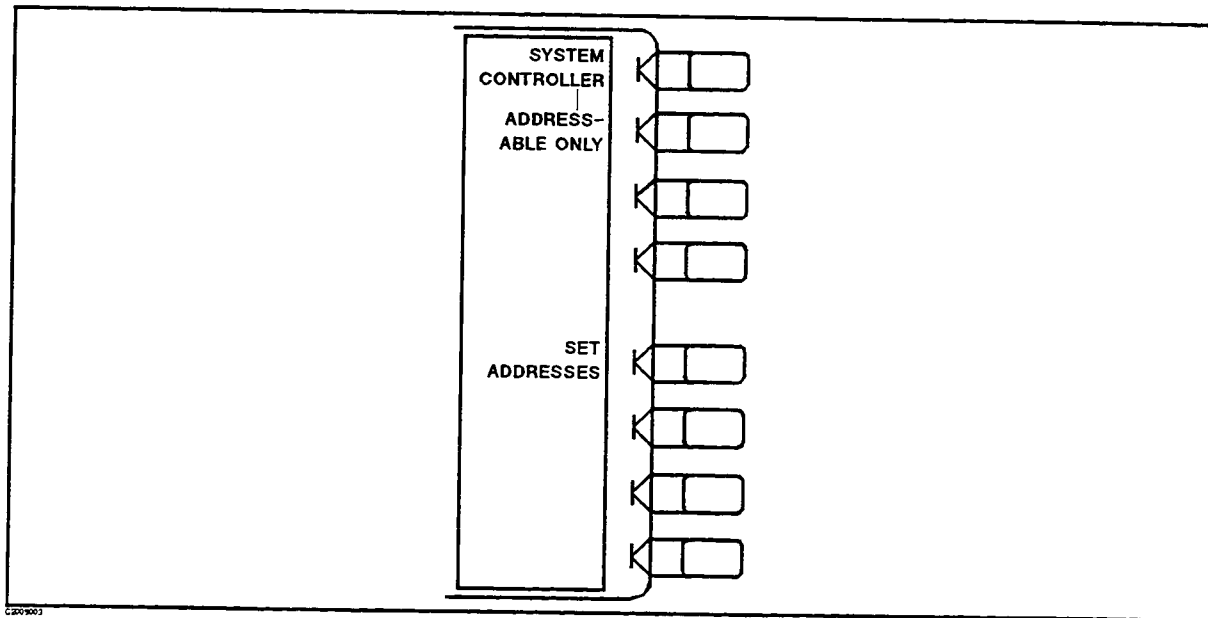

Figure 9-3. HP-IB Menu

SYSTEM CONTROLLER is the mode used when peripheral devices are to be used and there is no external controller. Refer to the description above.

The system controller mode can be used without knowledge of HP-IB programming. However, the HP-IB address must be entered for each peripheral device.

This mode can only be selected manually from the analyzer's front panel, and can be used only if no active system controller is connected to the system through HP-IB. If you try to set system controller mode when another system controller is present, the message "CAUTION: CAN'T CHANGE - ANOTHER CONTROLLER ON BUS" is displayed.

9-4 Instrument State Function Block

ADDRESSABLE ONLY is the mode used when an external controller controls peripheral devices or the analyzer. This mode is also used when the external computer passes control of the bus to the analyzer.

SET ADDRESSES goes to the address menu, which sets the HP-IB address of the analyzer, and to display and modify the addresses of peripheral devices in the system.

Address Menu

In communications through the Hewlett-Packard Interface Bus (HP-IB), each instrument on the bus is identified by an HP-IB address. This decimal-based address code must be different for each instrument on the bus.

This menu sets the HP-IB address of the analyzer. It also sets the HP-IB addresses the analyzer will use when talking to each peripheral.

Most of the HP-IB addresses are set at the factory and need not be modified for normal system operation. The standard factory-set addresses for instruments that may be part of the system are as follows:

Table 9-2. Default HP-IB Addresses

Instrument	HP-IB Address (decimal)
Analyzer	17
Plotter	05
Printer	01
Controller	21

The address displayed in this menu for each peripheral device must match the address set on the device itself. If the addresses do not match, they can be matched in one of two ways. Either the address set in the analyzer can be changed using the entry controls; or the address of the device can be changed using instructions provided in its manual. The analyzer's HP-IB address is changed through the keyboard controls, there is no physical HP-IB switch.

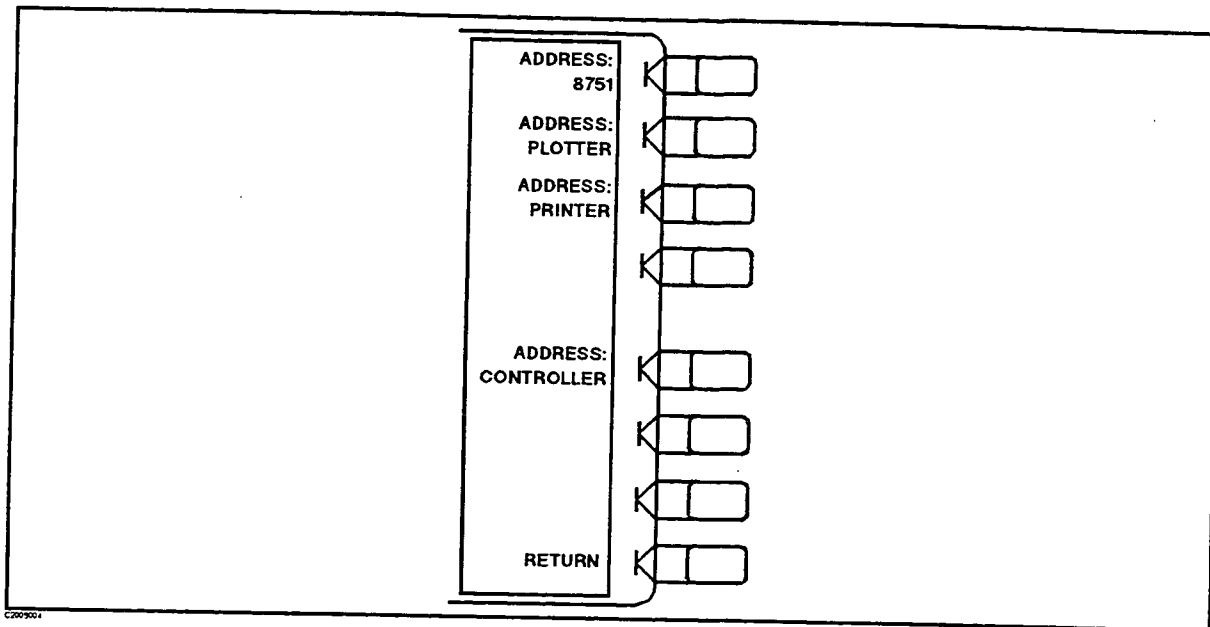

Figure 9-4. Address Menu

ADDRESS: 8751 sets the HP-IB address of the analyzer, using the entry controls. There is no physical address switch to set in the analyzer.

ADDRESS: PLOTTER (ADDRPLOT) sets the HP-IB address the analyzer will use to communicate with the plotter.

ADDRESS: PRINTER (ADDRPRIN) sets the HP-IB address the analyzer will use to communicate with the printer.

ADDRESS: CONTROLLER (ADDRCONT) sets the HP-IB address the analyzer will use to communicate with the external controller.

RETURN goes back to the HP-IB menu.

SYSTEM KEY

The HP-IB programming command is shown in parenthesis following the key or softkey.

This key presents the system menu.

System Menu

Figure 9-5. System Menu

IBASIC leads to a series of menus used to operate Instrument BASIC. Refer to "INSTRUMENT BASIC (Option 002)" in this chapter. This softkey will not appear if the analyzer is not equipped with Option 002.

SET CLOCK leads to a series of menus as shown in Figure 9-6, which sets an internal clock. Refer to "Clock Menu" in this chapter.

LIMIT MENU leads to a series of menus as shown in Figure 9-10, which defines limits or specifications with which to compare a test device. Refer to "LIMIT LINE AND LIMIT TESTING".

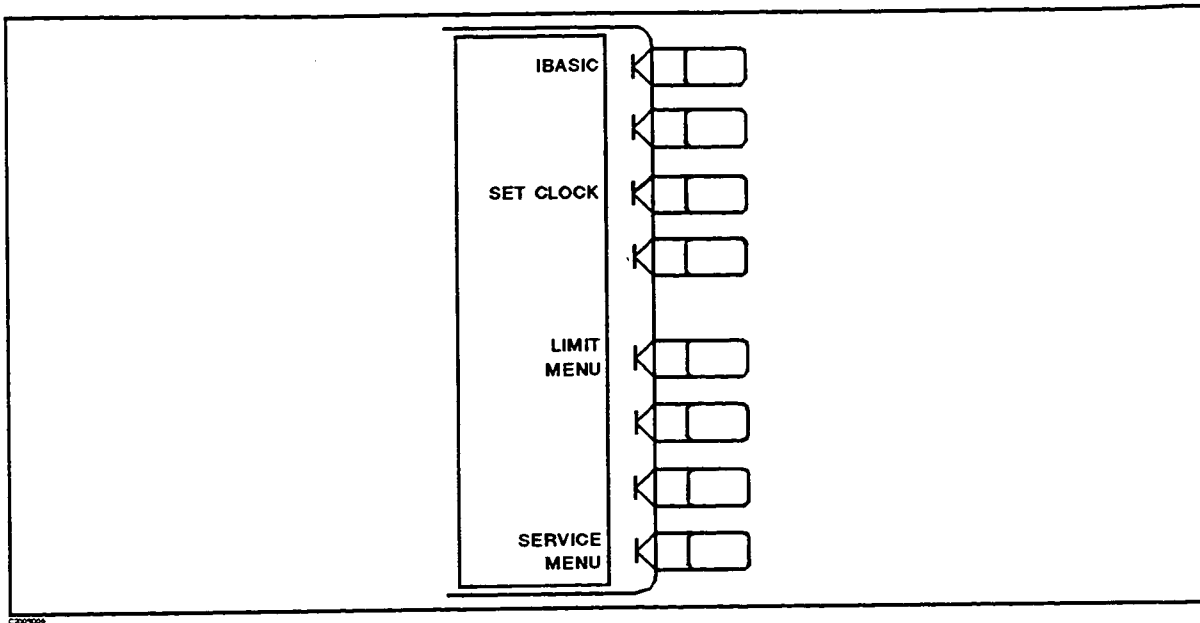
SERVICE MENU leads to a series of service menus described in detail in the *Maintenance Manual*.

SYSTEM Key

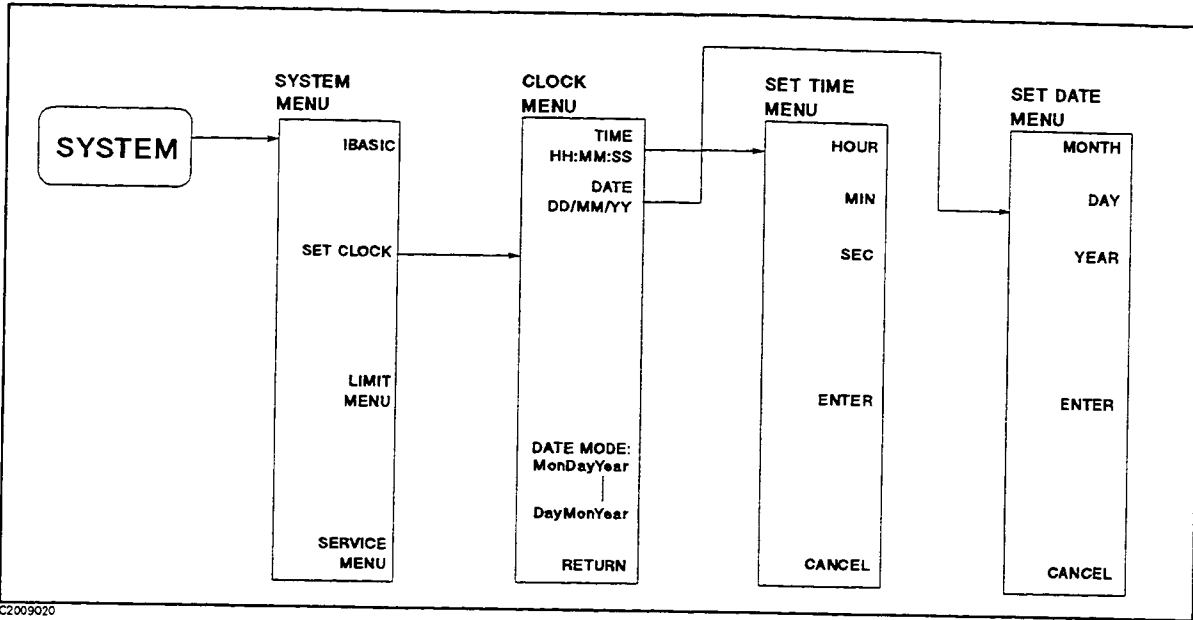

Figure 9-6. Softkey Menus Accessed from the **SET CLOCK** Softkey

Clock Menu

This menu is used to print the current time and date. When the analyzer prints or plots the data, the current time and date is printed or plotted before the information on the screen, if **COPY TIME** under the **COPY** key is turned ON.

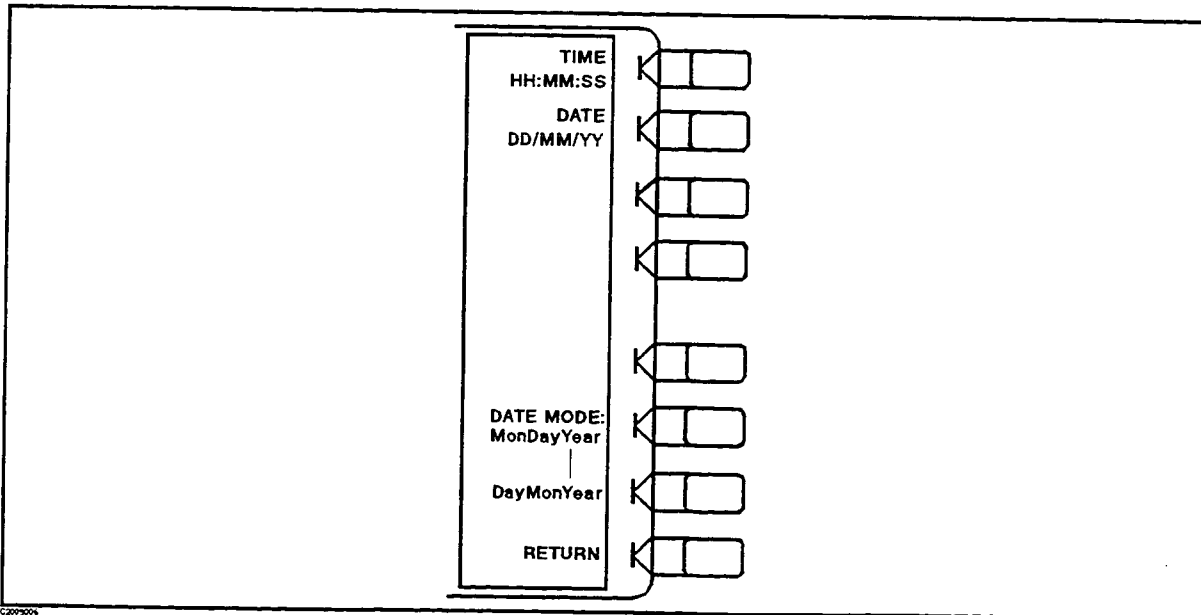

Figure 9-7. Clock Menu

TIME HH:MM:SS (**SETCTIME**) displays the current time when pressed. To adjust the time, refer to "Set Time Menu".

9-8 Instrument State Function Block

DATE MM/DD/YY (SETCDATE) displays the current date when pressed. To adjust the date, refer to “Set Date Menu”.

DATE MODE: MonDayYear (MONDYEAR) changes the displayed date to the “month:day:year” format.

DayMonYear (DAYMYEAR) changes the displayed date to the “day:month:year” format.

RETURN returns to the system menu.

Set Time Menu

This menu is used to set the internal clock.

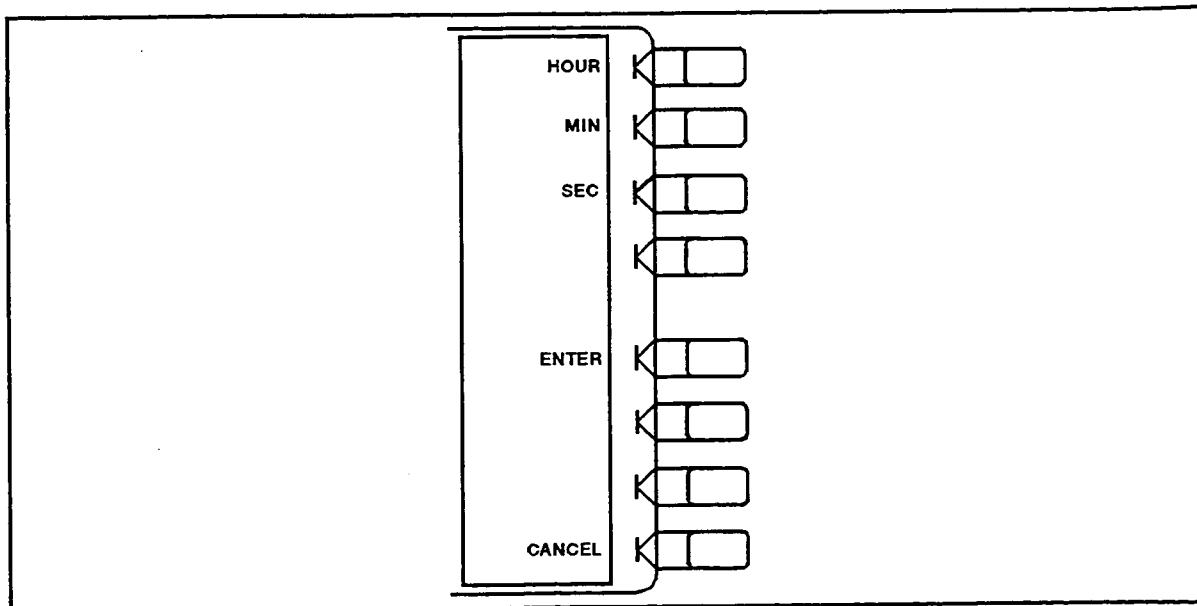

Figure 9-8. Set Time Menu

HOUR enables changing the hour setting using the knob or the numeric entry keys. After you change the hour setting, press **ENTER** to restart the clock.

MIN enables changing the minute setting using the knob or the numeric entry keys. After you change the minute setting, press **ENTER** to restart the clock.

SEC enables changing the second setting using the knob or the numeric entry keys. After you change the second setting, press **ENTER** to restart the clock.

ENTER restarts the internal clock.

CANCEL returns to the clock menu. Pressing this key will not affect the internal clock setting.

Set Date Menu

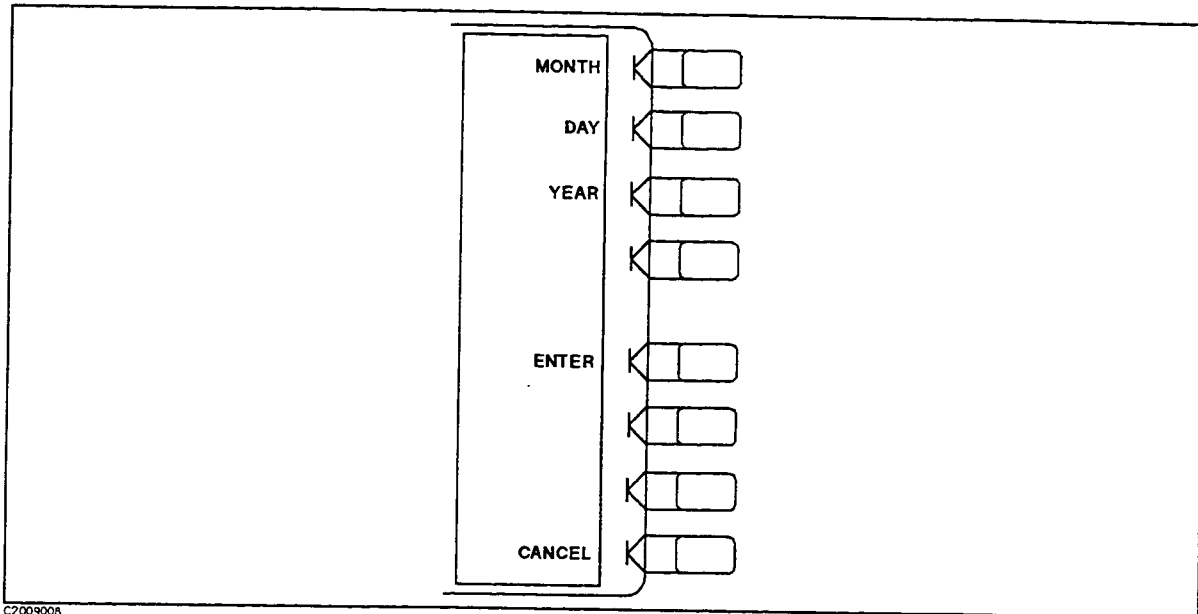

C2009008

Figure 9-9. Set Date Menu

MONTH enables changing the month setting using the knob or the numeric entry keys. After you change the month setting, press **ENTER** to restart the clock.

DAY enables changing the day setting using the knob or the numeric entry keys. After you change the day setting, press **ENTER** to restart the clock.

YEAR enables changing the year setting using the knob or the numeric entry keys. After you change the year setting, press **ENTER** to restart the clock.

ENTER restarts the internal clock.

CANCEL returns to the clock menu. Pressing this key will not affect the internal clock setting.

LIMIT LINE AND LIMIT TESTING

These are lines drawn on the display to represent upper and lower limits or device specifications with which to compare the device under test. Limits are defined by specifying several segments, where each segment is a portion of the stimulus span. Each limit segment has an upper and a lower starting limit value.

Limits can be defined independently for the two channels, up to 18 segments for each channel (a total of 36 for both channels). These can be in any combination of the two limit types.

Limit testing compares the measured data with the defined limits, and provides pass or fail information for each measured data point. An out-of-limit test condition is indicated in the following ways:

- Displaying a FAIL message on the screen
- Emitting a beep
- Displaying an asterisk in tabular listings of data
- Writing a bit into HP-IB event status register B
- Writing LOW-status of PASS/FAIL signal line of the I/O port on the analyzer rear panel.
Refer to Appendix C.

Limits are entered in tabular form. Limit lines and limit testing can be either ON or OFF while limits are defined. As new limits are entered, the tabular columns on the display are updated, and the limit lines (if on) are modified to the new definitions. The complete limit set can be offset in either stimulus or amplitude value.

An example of a measurement using limit lines and limit testing is provided in *the User's Guide*.

The series of menus for defining limits are accessed using the **SYSTEM** key. These menus are illustrated in Figure 9-10.

SYSTEM Key - Limit Line and Limit Testing

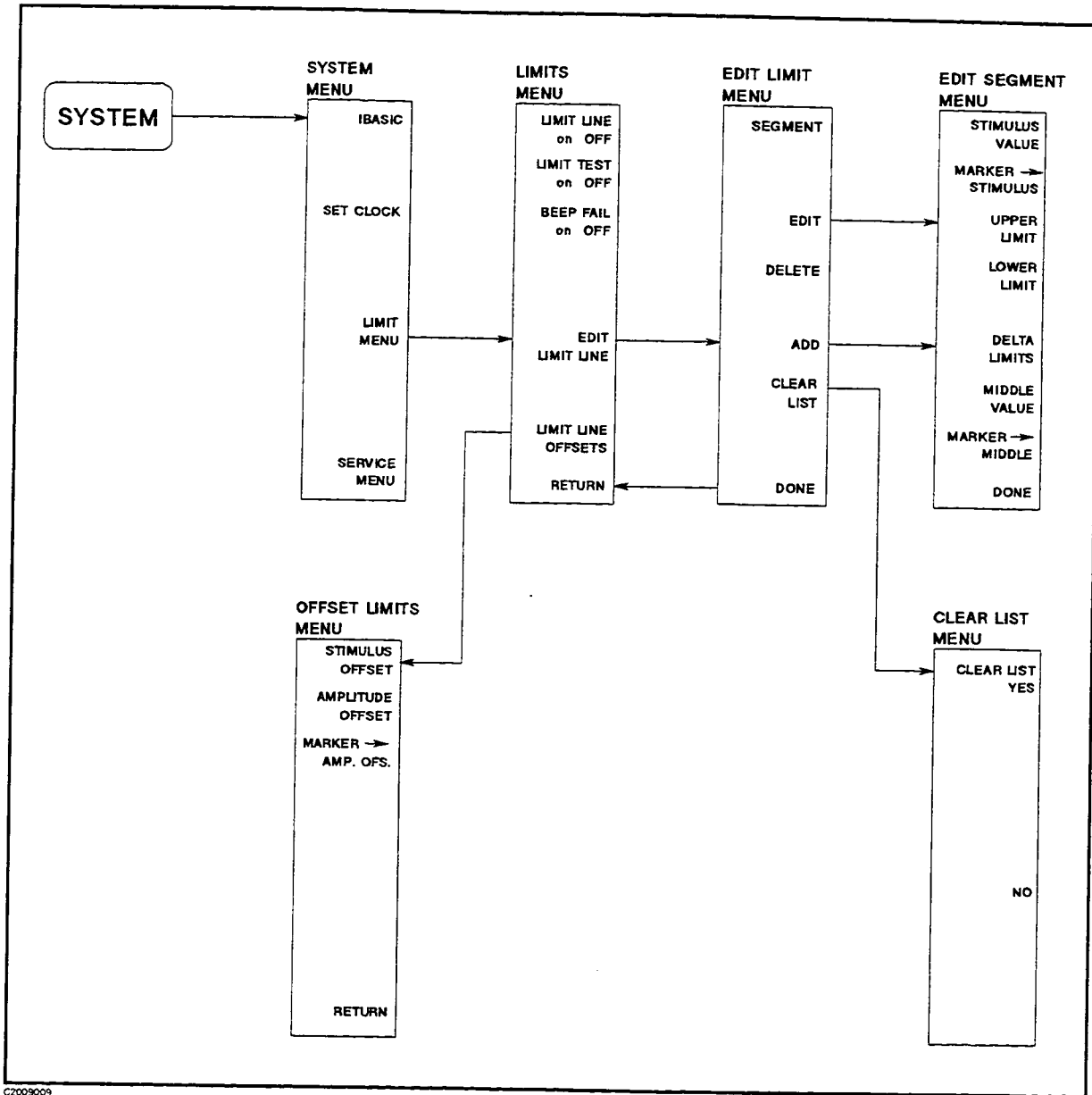

Figure 9-10. Softkey Menus Access from the **LIMIT MENU** softkey.

How Limit Lines are Entered

Before limit lines can be explained, the concept of “segments” must be understood. A segment is the node of two limit lines. Refer to Figure 9-11.

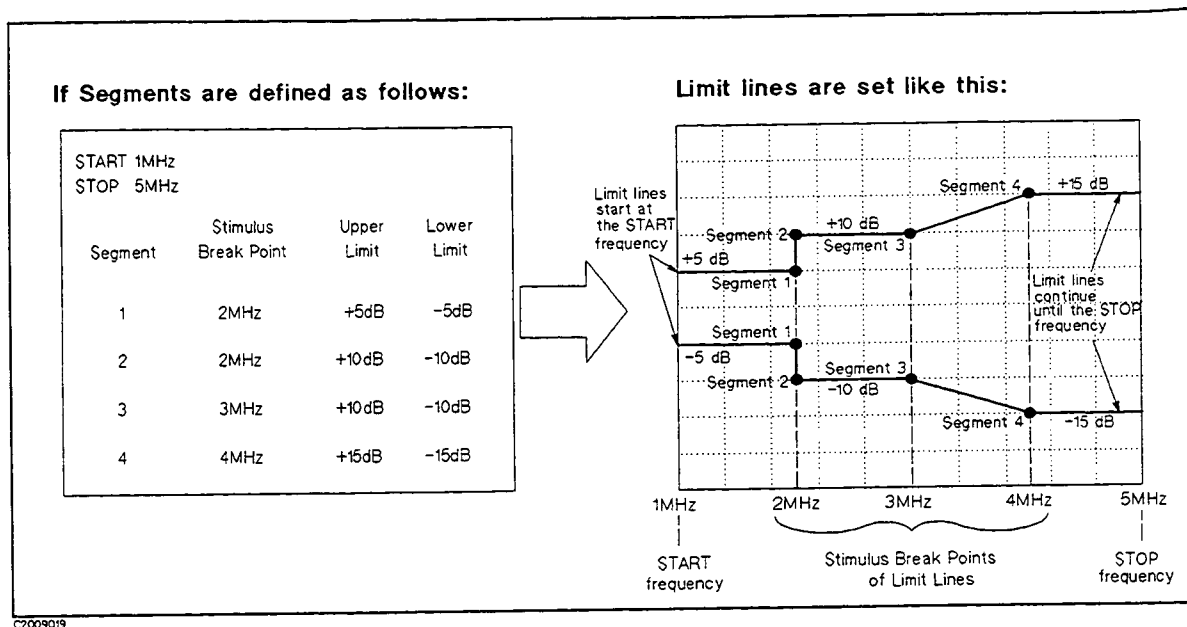

Figure 9-11. The Concept of Segments as a Point between Two Sets of Limit Lines

As you can see in Figure 9-11, segments are distinct points that define where limit lines begin or end. Limit lines span the distance between segments and represent the upper and lower test limits. Figure 9-11 shows another important aspect of limit lines: The most left hand side of set of limit lines will continue from the minimum stimulus value (START), and the most right hand side of set of limit lines will continue until the maximum stimulus value (STOP).

A segment is placed at a specific stimulus value (a single frequency for example). The first segment defines the limit line value hauls from the minimum stimulus value. Once its stimulus value is entered, the upper and lower test limit, +5 dB and -5 dB for example, needs to be supplied.

Defining a second segment defines where the first set of limit lines ends. This process is repeated to create different sets of limit lines, each having new upper and lower limits. Up to 18 segments can be entered.

Limits can be defined independently for the two channels.

The example in Figure 9-11 shows a combination of limit lines which change instantly and gradually.

Segment 1 is at 2 MHz has an upper and lower limit of +5 and -5 dB, respectively. Notice the upper and lower limit lines start at the START frequency (1 MHz) and end at segment 1.

Segment 2 is also at 2 MHz with different upper and lower limits of +10 dB and -10 dB, changing the limit values instantly.

Segment 3 is at 3 MHz with the same limit value as segment 2 to obtain a flat limit lines.

SYSTEM Key - Limit Line and Limit Testing

Segment 4 is at 4 MHz with upper and lower limit values of +15 dB and -15 dB, changing the limit values gradually. Notice the upper and lower limit lines start at the segment and continue until the STOP frequency (5 MHz).

Note



Limit lines cannot be cut, so when limit lines are needed partially along the stimulus axis, the non-limit-testing portion must be entered also. Set the non-limit-testing portion by forcing the upper and lower limit values out of range, +500 dB and -500 dB for example.

Both an upper limit and a lower limit (or delta limits) must be defined: if only one limit is required for a particular measurement, force the other limit out of range, +500 dB or -500 dB for example.

Turning Limit Lines Limit Testing On and Off

Limit lines and limit testing features are OFF unless explicitly turned ON by the user. After entering the limit line information, you may turn ON the limit line feature and optionally the limit testing features. Turning these features OFF has no effect on the entered limit line information.

Segments Entering Order Needs Notice

Generally, the segments do not have to be entered in any particular order: the analyzer automatically sorts them and lists them on the display in increasing order of stimulus value.

One exception is when two segments have the same stimulus value as described in Figure 9-11. If the same stimulus values exist, the analyzer draws the limit lines according to entered segment order. For example in Figure 9-11, segment 1 should be entered in advance of segment 2.

Saving the Limit Line Table

Limit line information is lost if **PRESET** is pressed or if the line switch is turned OFF. However, the **SAVE** and **RECALL** keys can save limit line information along with all other current analyzer settings. Limit line table information can be saved on a disk.

Offsetting the Stimulus or Amplitude of the Limit Lines

All limit line entries can be offset in either stimulus or amplitude values. The offset affects all segments simultaneously.

Supported Display Formats

Limit *lines* are displayed only in Cartesian format. In polar and Smith chart formats, limit testing of one value *is* available: the value tested depends on the marker mode and is the magnitude or the first value in a complex pair. The message "NO LIMIT LINES DISPLAYED" is shown on the display in polar and Smith formats.

Use a Sufficient Number of Points or Errors May Occur

Limits are checked only at the actual measured data points. If you do not select a sufficient number of points, it is possible for a device to be out of specification without a limit test failure indication.

To avoid this, be sure to specify a high enough number of points. In addition, if specific stimulus points must be checked, use the list sweep features described in Chapter 5 so that the actual measured data points are checked, exactly.

Displaying, Printing, or Plotting Limit Test Data

The “list values” feature in the copy menu prints or displays a table of each measured stimulus value. The table includes limit line and/or limit test information (if these functions are turned on). If limit testing is ON, an asterisk “*” is listed next to any measured value that is out of limits.

If the limit lines are ON, and other listed data allows sufficient space, the following will also be displayed:

- Upper limit and lower limit
- The margin by which the device passes or fails the nearest limit

For more information about the list values feature, refer to “Copy More Menu” in Chapter 10.

Results of Plotting or Printing the Display with Limit Lines ON

If limit lines are on, they are shown when you print or plot the display. If limit testing is ON, the PASS or FAIL message is included as well.

Limit Menu

This menu independently toggles the limit lines, limit testing, and limit fail beeper. It also leads to the menus that define and modify the limits.

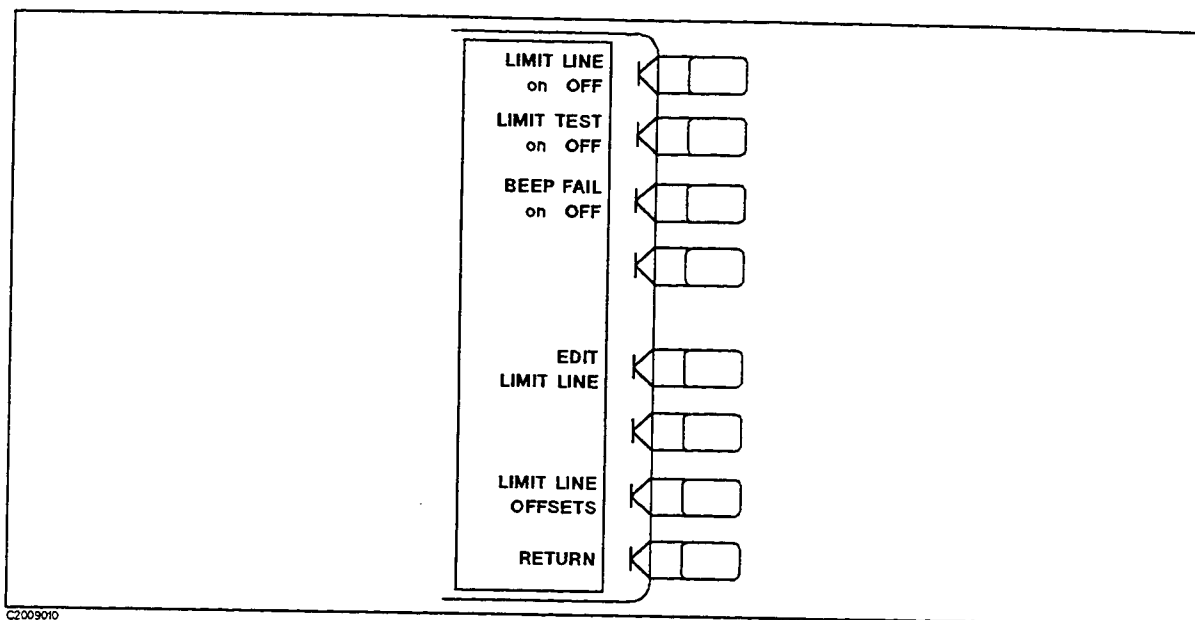

Figure 9-12. Limits Menu

LIMIT LINE on OFF (LIMILINEON, LIMILINEOFF) turns limit lines ON or OFF. To define limits, use the **EDIT LIMIT LINE** softkey described below. If limits have been defined and limit lines are turned on, the limit lines are displayed on the display for visual comparison of the measured data in all Cartesian formats.

If limit lines are ON, they can be saved in disk with an instrument state. In a listing of values from the copy more menu with limit lines ON and limit test ON, the upper limit and lower limit are listed together with the pass or fail margin, as long as other listed data allows sufficient space.

LIMIT TEST on OFF (LIMITESTON, LIMITESTOFF) turns limit testing ON or OFF. When limit testing is ON, the data is compared with the defined limits at each measured point. Limit tests occur at the end of each sweep, whenever the data is updated and when limit testing is first turned ON.

Limit testing is available for both magnitude and phase values in Cartesian formats. In polar and Smith chart formats, the value tested depends on the marker mode and is the magnitude or the first value in a complex pair. The message "NO LIMIT LINES DISPLAYED" is displayed in polar and Smith chart formats if limit lines are turned ON.

Five different ways of indications of pass or fail status are provided when limit testing is ON.

- A PASS or FAIL message is displayed at the right of the display.
- The limit fail beeper sounds if it is turned ON.
- In a listing of values using the copy menu, an asterisk * is shown next to any measured point that is out of limits.
- A bit is set in the HP-IB status byte.

- The PASS/FAIL line in the I/O port on the analyzer rear panel goes to TTL LOW level.

BEEP FAIL on OFF (BEEPFAILON, BEEPFAILOFF) turns the limit fail beeper ON or OFF. When limit testing is ON and the fail beeper is ON, a beep is emitted each time a limit test is performed and a failure detected. The limit fail beeper is independent of the warning beeper and the operation complete beeper, both of which are described in "Display More Menu" in Chapter 6.

EDIT LIMIT LINE (EDITLIML) displays a table of limit segments on the lower half of the display. The edit limits menu is presented so that limits can be defined or changed.

LIMIT LINE OFFSETS leads to the offset limits menu, which offsets the complete limit set in either stimulus or amplitude value.

RETURN goes back to the system menu.

Edit Limits Menu

This menu is used to add new segments or select existing segments to be edited. The **ADD** and **EDIT** softkeys in this menu provides the edit segment menu (described later), which lets you select stimulus and limit values.

Note



Before editing the limit lines, it is convenient to turn the limit lines on using the **LIMIT LINE on OFF** softkey. This displays the limit lines while you editing.

A table of limit values appears on the display when this menu is provided. A thorough description of how segments work is described at the beginning of this section. Read that information before continuing.

For each segment, the table shows the segment number, stimulus value, upper limit, and lower limit. Limit values can be entered as upper and lower limits or as delta limits with a middle value.

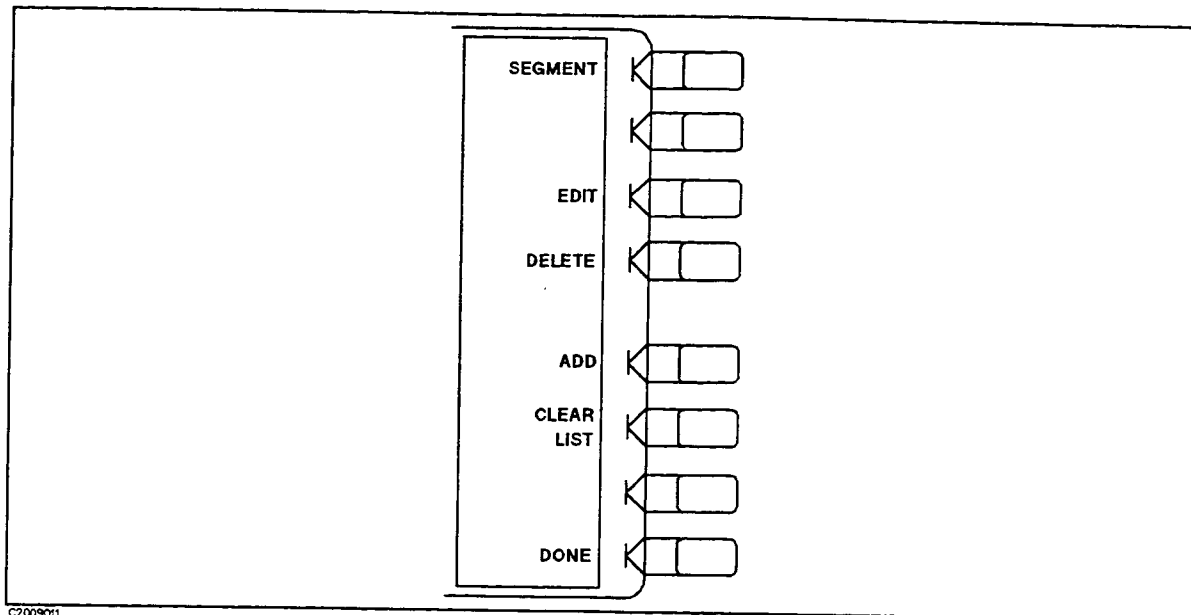

Figure 9-13. Edit Limits Menu

SEGMENT specifies which limit segment in the table is to be edited. A maximum of eight sets of segment values are displayed at one time, and the list can be scrolled up or down to show other segment entries. Use the entry block controls to move the pointer “>” next to the required segment number. The indicated segment can then be edited or deleted. If the table of limits is designated “EMPTY”, new segments can be added using the **ADD** or **EDIT** softkey.

EDIT (LIMSEDI) displays the edit segment menu, which defines or modifies the stimulus value and limit values of a specified segment. If the table was empty, a default segment is displayed.

DELETE (LIMSDEL) deletes the segment indicated by the pointer “>”.

ADD (LIMSADD) displays the edit segment menu and adds a new segment to the end of the list. The new segment is initially a duplicate of the segment indicated by the pointer “>” and selected with the **SEGMENT** softkey. If the table was empty, a default segment is displayed.

CLEAR LIST leads to the clear list menu, which clears all of the segments in the limit test.

DONE (LIMEDONE) sorts the limit segments and displays them on the display in increasing order of stimulus values. The limits menu is returned to the screen.

Edit Segment Menu

This menu is used to set the value of the individual limit segments. The segment to be modified, or a default segment, is selected in the edit limits menu.

The stimulus value can be set with the controls in the entry block or with a marker (the marker is turned ON automatically when this menu is presented). The limit values can be defined as upper and lower limits, or delta limits and middle value.

As new values are entered, the tabular listing of limit values is updated.

As described in the beginning of this section, generally segments do not have to be listed in any particular order: the analyzer sorts them automatically in increasing order of start stimulus value when the **DONE** key in the edit limits menu is pressed. However, the easiest way to enter a set of limits is to start with the lowest stimulus value and define the segments from left to right of the display, with limit lines turned ON as a visual check.

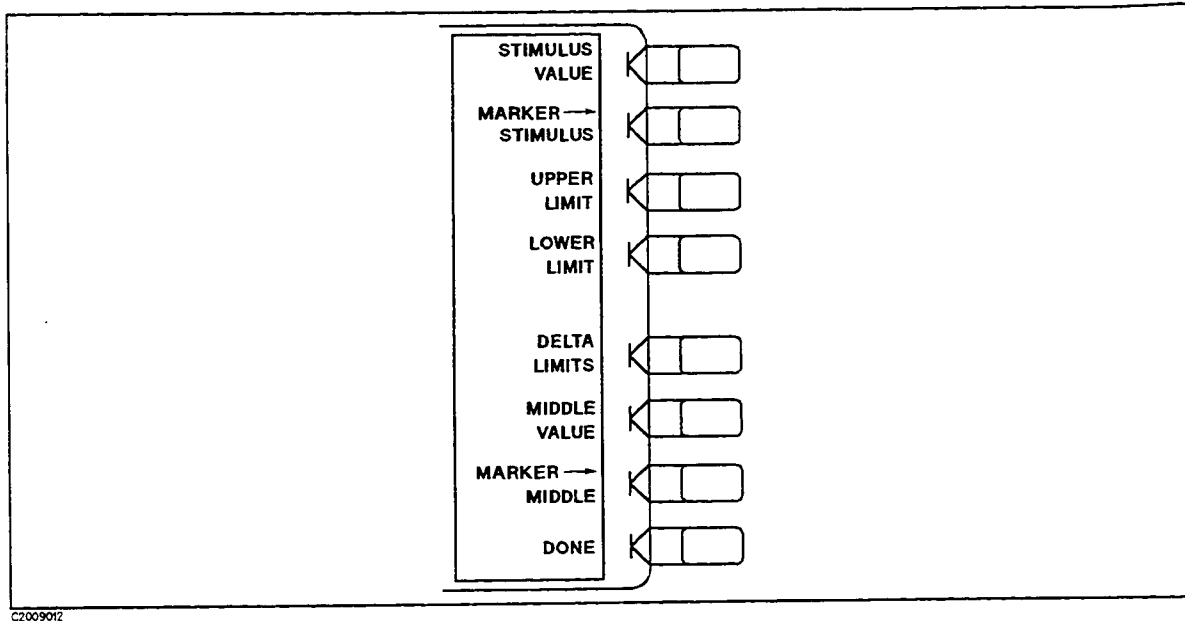

Figure 9-14. Edit Segment Menu

STIMULUS VALUE (LIMS) sets the starting stimulus value of a segment, using entry block controls.

MARKER → STIMULUS (MARKSTIM) sets the stimulus value of a segment using the active marker. Move the marker to the desired starting stimulus value before pressing this key, and the marker stimulus value is entered as the segment stimulus value.

UPPER LIMIT (LIMU) sets the upper limit value for the segment. If a lower limit is specified, an upper limit must also be defined. If no upper limit is required for a particular measurement, force the upper limit value out of range (for example +500 dB)

When **UPPER LIMIT** or **LOWER LIMIT** is pressed, all the segments in the table are displayed in terms of upper and lower limits, even if they were defined as delta limits and middle value.

If you attempt to set an upper limit that is lower than the lower limit, or vice versa, both limits will be automatically set to the same value.

LOWER LIMIT (LIML) sets the lower limit value for the segment. If an upper limit is specified, a lower limit must also be defined. If no lower limit is required for a particular measurement, force the lower limit value out of range (for example -500 dB).

DELTA LIMITS (LIMD) sets the limits an equal amount above and below a specified middle value, instead of setting upper and lower limits separately. This is used in conjunction with **MIDDLE VALUE** or **MARKER → MIDDLE**, to set limits for testing a device that is specified at a particular value plus or minus an equal tolerance.

SYSTEM Key - Limit Line and Limit Testing

For example, a device may be specified at $-5 \text{ dB} \pm 3 \text{ dB}$. Enter the middle value as -5 dB and the delta limits as 3 dB .

When **DELTA LIMITS** or **MIDDLE VALUE** is pressed, all the segments in the table are displayed in these terms, even if they were defined as upper and lower limits.

MIDDLE VALUE (LIMM) sets the midpoint for **DELTA LIMITS**. It uses the entry controls to set a specified amplitude value vertically centered between the limits.

MARKER → **MIDDLE** (MARKMIDD) sets the midpoint for **DELTA LIMITS** using the active marker to set the middle amplitude value of a limit segment. Move the marker to the desired value or device specification, and press this key to make that value the midpoint of the delta limits. The limits are automatically set an equal amount above and below the marker.

DONE (LIMSDON) terminates a limit segment definition, and returns to the edit limits menu.

Clear List Menu

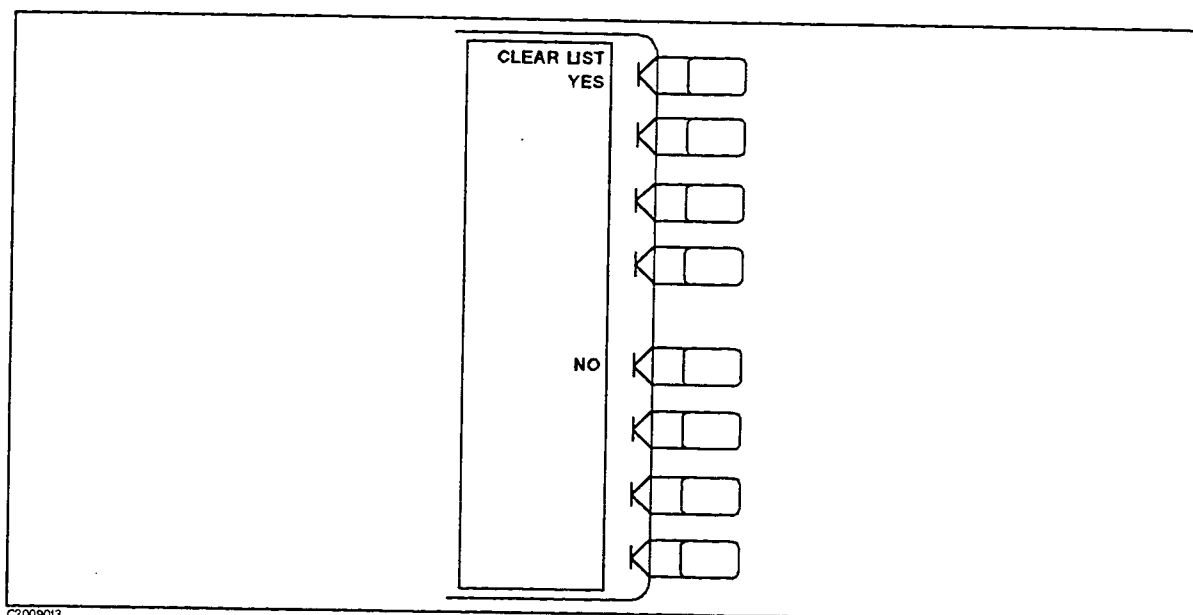

Figure 9-15. Clear List Menu

CLEAR LIST YES (LIMCLEL) clears all of the segments in the limit line and returns to the edit limit menu.

NO cancels clearing the segment and returns to the edit limit menu.

Offset Limit Menu

This allows all segments to be offset in either stimulus value or amplitude value. This is useful for changing the limits to correspond with a change in the test setup, or for device specifications that differ in stimulus or amplitude.

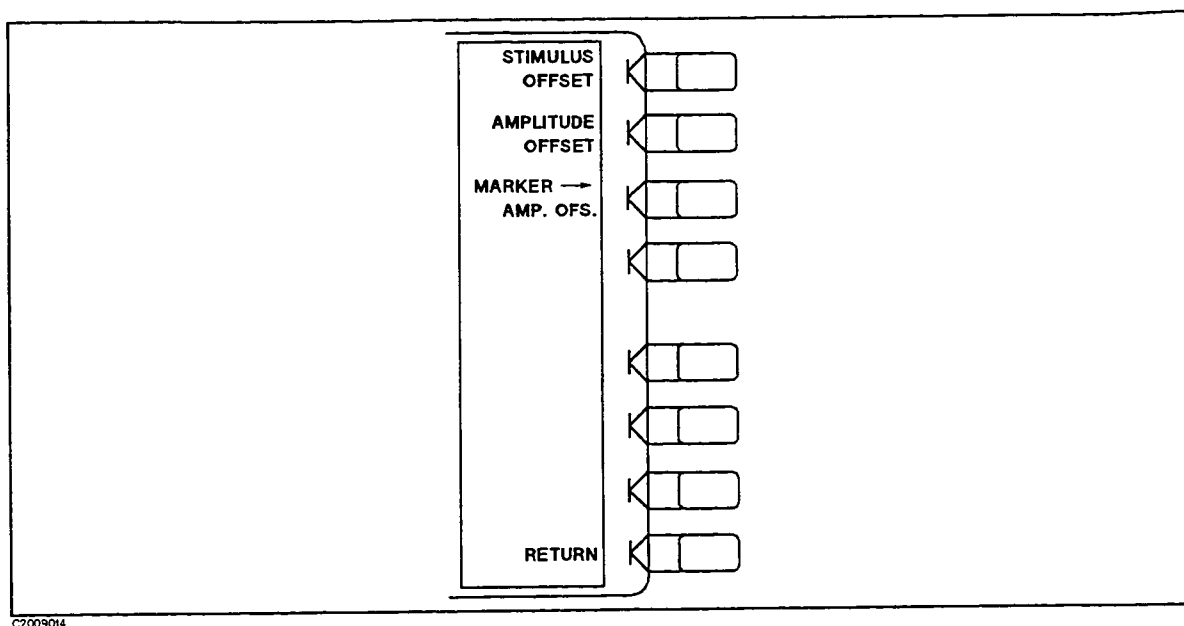

Figure 9-16. Offset Limit Menu

STIMULUS OFFSET (LIMISTIO) adds to or subtracts an offset from the stimulus value. This allows limits already defined to be used for testing in a different stimulus range. Use the entry block controls to specify the offset required.

AMPLITUDE OFFSET (LIMIAMP0) adds or subtracts an offset in amplitude value. This allows previously defined limits to be used at a different power level. For example, if attenuation is added to or removed from a test setup, the limits can be offset an equal amount.

MARKER -> AMP. OFS. (LIMIMAOF) uses the active marker to set the amplitude offset. Move the marker to the desired middle value of the limits and press this softkey. The limits are then moved so that they are centered an equal amount above and below the marker at that stimulus value.

RETURN goes back to the limit line menu.

9 Instrument State Block

INSTRUMENT BASIC (Option 002)

HP Instrument BASIC gives the analyzer programmability without any external controller. HP Instrument BASIC is subset of HP BASIC and allows all of the analyzer's measurement capabilities and any other HP-IB compatible instrument to be programmed. For more information of Instrument BASIC, refer to *Using HP Instrument BASIC with the HP 8751A*, and the *HP Instrument BASIC Manual Set* furnished to Option 002.

Making Hard Copies

INTRODUCTION

About Making Hard Copies, Where Compatible Printers and Plotters are Mentioned

The analyzer can use HP-IB to output measurement results directly to a compatible printer or plotter, without the use of an external controller. The information shown on the display can be copied to a compatible Hewlett-Packard plotter or graphics printer. A plotter provides better resolution than a printer for data displays, while a printer provides higher speed for tabular listings. Refer to the General Information and Specifications section for information about compatible plotters and printers.

Where to Find Tutorial Information

Tutorial information on how to plot or print is supplied in the *User's Guide*.

Printing/Plotting with or without a Controller on the Bus

To generate a plot or printout from the front panel when there is no other controller on the bus, the analyzer must be in the system controller HP-IB mode. If a controller is connected to the analyzer, the analyzer must take control from the controller to initiate a hard copy. To do this, the analyzer must be in the addressable mode by receiving a pass control command from the controller. The controller essentially gives the analyzer permission to control the bus.

Refer to "BUS MODE" in Chapter 12 for HP-IB controller modes and "**LOCAL** Key" in Chapter 9 for setting addresses.

Note

The ASCII Save menu is provided under the **SAVE** key to save the graphics image on the screen in an HP-GL file on the disk. For more information, refer to Chapter 11.

COPY Key

PRINT/PLOT BUFFER

The analyzer can continue operation while a hard copy is in progress. To abort a hard copy before it is finished, press **COPY ABORT**. If a hard copy is in progress and a second hard copy is attempted, the message "PRINT/PLOT IN PROGRESS, ABORT WITH COPY ABORT" is displayed and the second attempt is ignored. An aborted hard copy cannot be continued: the process must be initiated again if a copy is still required.

COPY KEY

The HP-IB programming command is shown in parenthesis following the key or softkey.

The **COPY** key provides access to the menus used for controlling external plotters and printers and defining the plot parameters.

Copy Menu

This copies the display to a printer or to a plotter using the default plot parameters, without the need to access other menus. For user-defined plot parameters, a series of additional menus is available.

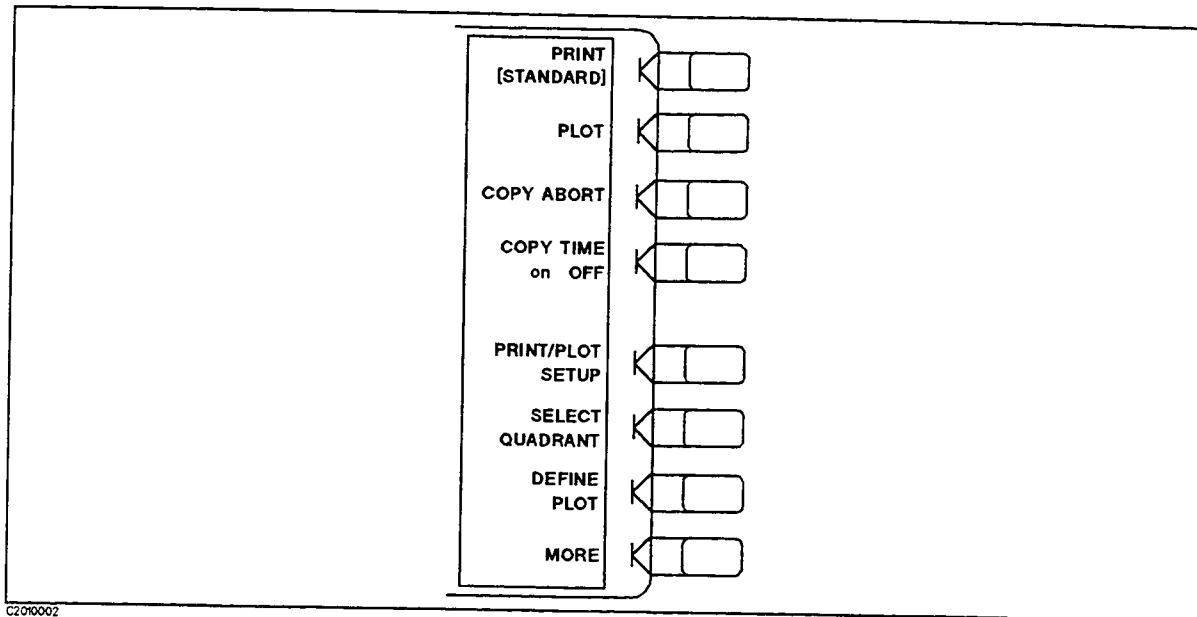

Figure 10-2. Copy Menu

When the print or plot function is engaged, the analyzer takes a “snapshot” of the display and sends it to the printer or plotter through a buffer. Once the data is transferred to the buffer, the analyzer is free to continue measurements while the data is being printed or plotted.

PRINT [STANDARD] (PRINALL) identifies the printer selected in the print/plot setups menu: either **STANDARD** for a black and white printer or **COLOR** for a color printer. The default setting at power on is **STANDARD**. When pressed, this softkey causes an exact copy of the display to be printed.

PLOT (PLOT) plots the display to a compatible HP graphics plotter, using the currently defined plot parameters (or default parameters). Any or all displayed information can be plotted, except the softkey labels and the frequency list table in EDIT mode, or limit table in EDIT mode. (List values, operating parameters, or cal kit definition can be plotted using the screen menu explained later in this chapter. However, this is considerably slower than printing.)

Note

Before pressing **PRINT** or **PLOT**, you must:



- set the analyzer to the system controller mode.
- make sure the analyzer's plotter HP-IB address and the plotter set HP-IB address match.

COPY ABORT (COPA) aborts a plot or print in progress.

CONFIG PLOT leads to the configure plot menu, which select pens to be used for plotting different elements of a plot.

PRINT/PLOT SETUP presents the print/plot setup menu. This menu allows you to copy the display to a printer capable of graphics plotting or tabular listing. For information on compatible printers and plotter with the analyzer, refer to the General Information section.

SELECT QUADRANT leads to the select quadrant menu, which provides the capability of drawing quarter-page plots. This is not used for printing.

DEFINE PLOT leads to the define plot menu, which specifies which elements of the display are to be plotted. This is not used for printing.

MORE leads to the copy more menu, which prints or plots the measurement value list, operation parameter list, calibration kit definition list, list sweep table, or limit test table.

Print/Plot Setup Menu

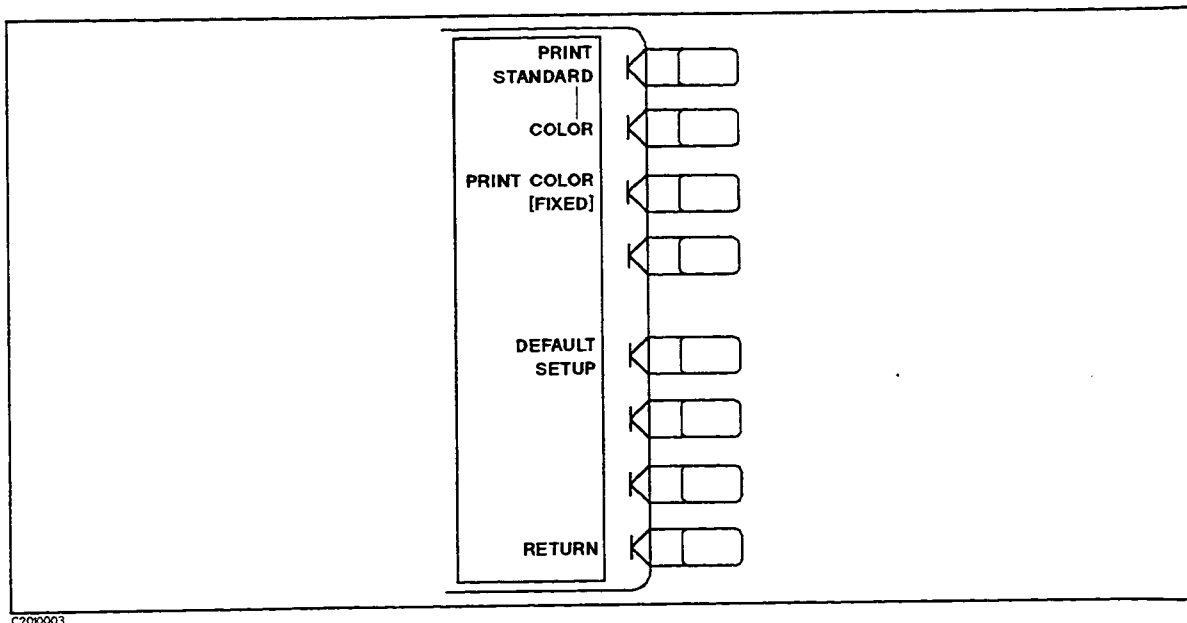

Figure 10-3. Print/Plot Setups Menu

PRINT: STANDARD (PRIS) sets the print command to the default selection, a standard printer that prints in black only or a color printer (PaintJet) to yield a black-only print.

COLOR (PRIC) sets the print command to default to color. The **PRINT [COLOR]** command does NOT work with a black and white printer.

PRINT COLOR [FIXED] (PRICFIXE, PRICVARI) toggles the printing color between **[FIXED]** and **[VARIABLE]**. If "FIXED" is selected, the analyzer prints a hard copy with default colors. If "VARIABLE" is selected, the analyzer prints a hard copy with colors as similar as possible to the display colors, which can be adjusted by the user. Refer to "**DISPLAY KEY**" in Chapter 6 for display colors adjustment.

Note



Because of the limited number of the printer ink colors, the printed color will not be the same as the displayed.

DEFAULT SETUP (DFLT) resets the plotting parameters to their default values. These defaults are as follows:

Table 10-1. Default Plotting Parameters

- Select quadrant: Full page
- Define plot: All plot elements on
- Plot scale: Full
- Plot speed: Fast
- Line type: 7 (solid line) for both trace and memory

Default setups do not apply to printing.

RETURN returns to the copy menu.

Select Quadrant Menu

This selects a full-page plot, or a quarter-page plot in any quadrant of the page.

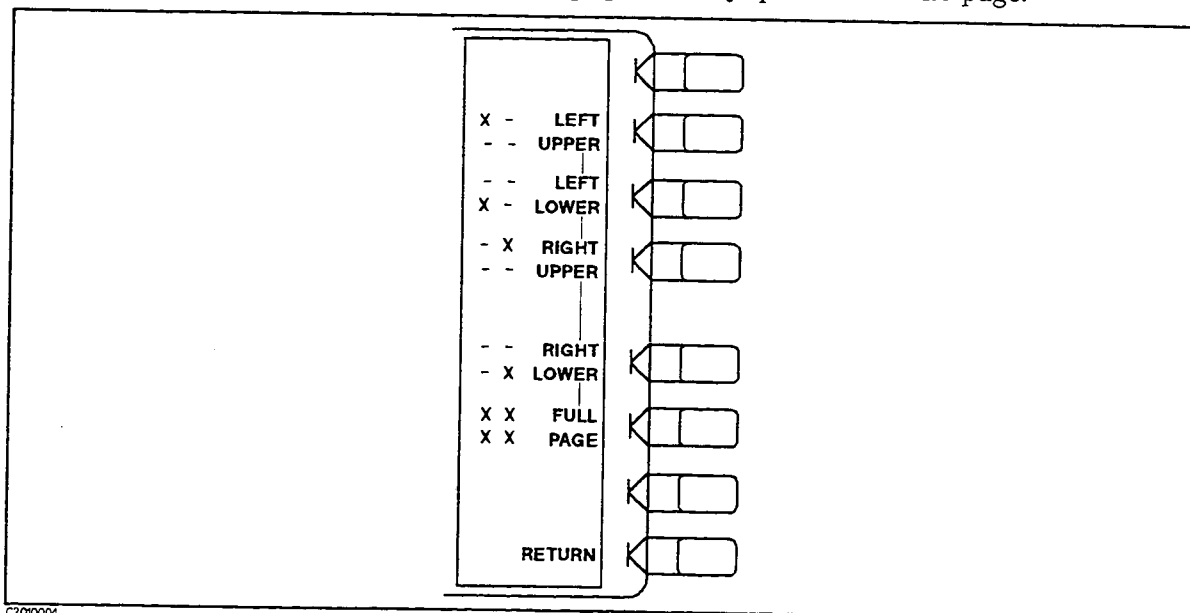

Figure 10-4. Select Quadrant Menu

LEFT UPPER (LEFU) draws a quarter-page plot in the upper left quadrant of the page.

LEFT LOWER (LEFL) draws a quarter-page plot in the lower left quadrant of the page.

RIGHT UPPER (RIGU) draws a quarter-page plot in the upper right quadrant of the page.

RIGHT LOWER (RIGL) draws a quarter-page plot in the lower right quadrant of the page.

FULL PAGE (FULP) draws a full-size plot according to the scale defined with **SCALE PLOT** in the define plot menu (described next).

RETURN returns to the copy menu.

Define Plot Menu

This menu allows selective plotting of portions of the measurement display. Different plot elements can be turned on or off as required. In addition, different selections are available for plot speed and plot scale, to allow plotting on transparencies and preprinted forms.

The definition selected in this menu affects the save graphics function under the **SAVE** key, which saves a graphics screen image in an HP-GL file on the disk.

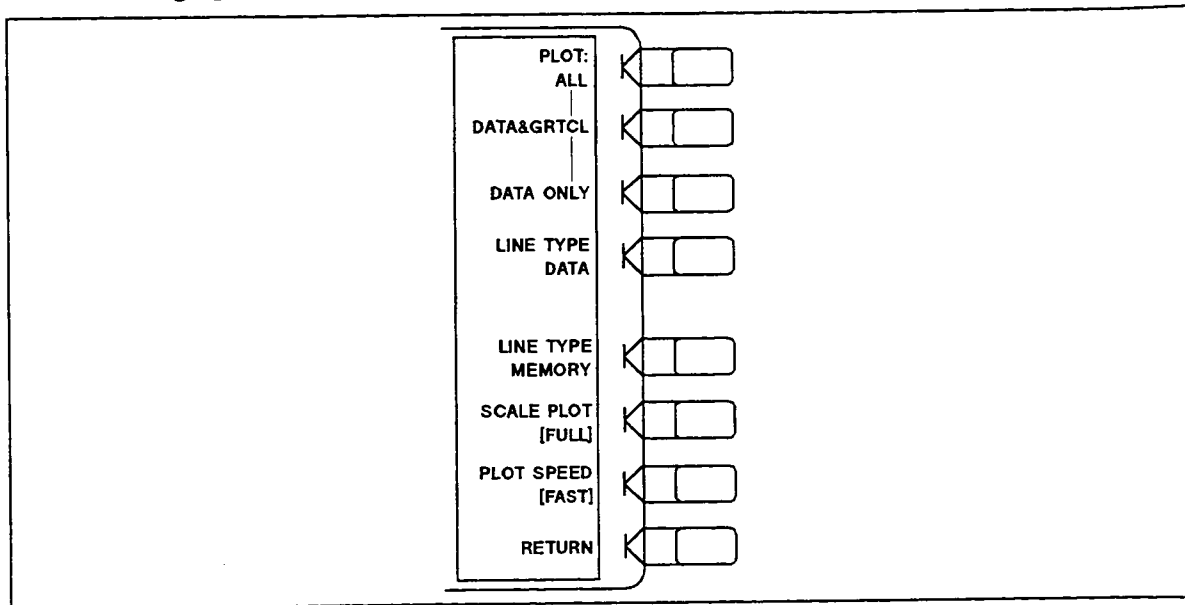

C2010005

Figure 10-5. Define Plot Menu

Pen Numbers

Pen numbers for each display elements are fixed as follows:

Table 10-2. Pen Numbers

Display Element	Channel 1	Channel 2
Data	1	2
Memory	5	6
Graticule	3	3
Text	1 / 4 / 5	2 / 4 / 6
Marker	1 / 5	2 / 6

PLOT: ALL (PLOALL) selects to plot all the information displayed on the display except for the softkey labels.

10: Making Hard Copies

COPY Key

DATA & GRATCL (PLODGRAT) selects to plot the measured data and memory data, and also the graticules.

DATA ONLY (PLODONLY) selects to plot only the measured data and memory data.

LINE TYPE DATA (LINTDATA) selects the line type of the trace data for plotting. The default line is a solid unbroken line.

LINE TYPE MEMORY (LINTMEMO) selects the line type of the memory trace for plotting. The default line type is a solid unbroken line.

SCALE PLOT leads to the scale plot menu, which selects a plot scale.

PLOT SPEED (PLOSFAST, PLOSSLOW) provides two plot speeds, **FAST** and **SLOW**. Fast is the proper plot speed for normal plotting. Slow plot speed is used for plotting directly on transparencies: the slower speed provides a more consistent line width.

RETURN returns to the copy menu.

Scale Plot Menu

This menu selects a plot scale, **FULL**, **UPPER GRATICULE**, and **LOWER GRATICULE**.

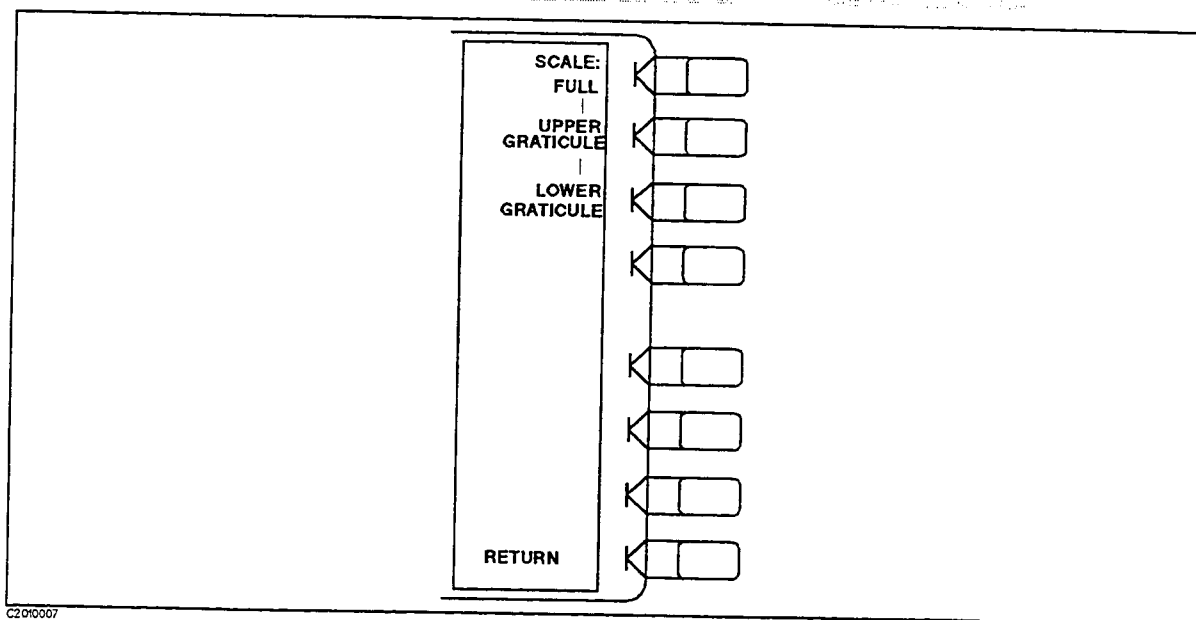

Figure 10-6. Scale Plot Menu

SCALE: FULL (SCAPFULL) selects the normal full size scale for plotting on blank paper, and includes space for all display annotations such as marker values, stimulus values, etc. The entire display fits within the user-defined boundaries of P1 and P2 on the plotter, while maintaining the exact same aspect ratio as the display.

UPPER GRATICULE, **LOWER GRATICULE** (SCAPGU, SCAPGL) expands or reduces the horizontal and vertical scale so that the graticule lower left and upper right corners exactly correspond to the user-defined P1 and P2 scaling points on the plotter. In the dual display mode, the applicable graticule is channel 1 for **UPPER GRATICULE**, or channel 2 for **LOWER GRATICULE**.

This is convenient for plotting on preprinted rectangular or polar forms (for example, on a Smith chart).

To plot on a rectangular preprinted graticule, set P1 of the plotter at the lower left corner of the preprinted graticule, and set P2 at the upper right corner.

To plot on polar and Smith chart formats as an accurate circle, set P1 and P2 so that a rectangular defined by P1 and P2 become a square because the outer circumference is identical to an inscribed circle in the rectangle.

When the display is split (for example, **SPLIT DISP ON**, **MKR LIST ON**), **UPPER** set the upper graticule to the plot area defined P1 and P2 and **LOWER** set the lower graticule to the plot area. When the display is not split, **UPPER** and **LOWER** are the same. (Refer to Figure 10-7.)

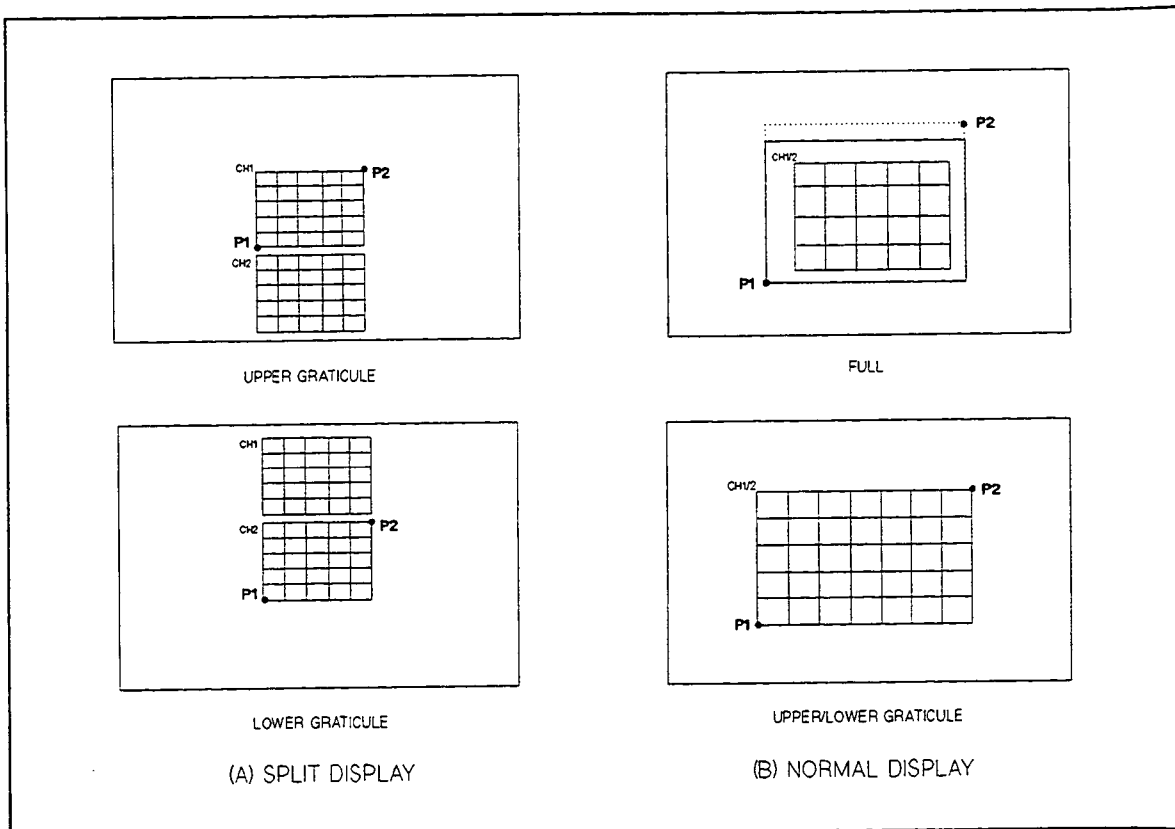

C2010014

Figure 10-7. Full, Upper, and Lower Graticule

10: Making Hard Copies

Copy More Menu

This menu provides tables of operating parameters, measured data values, and cal kit definitions, which can be copied from the screen to a printer or plotter.

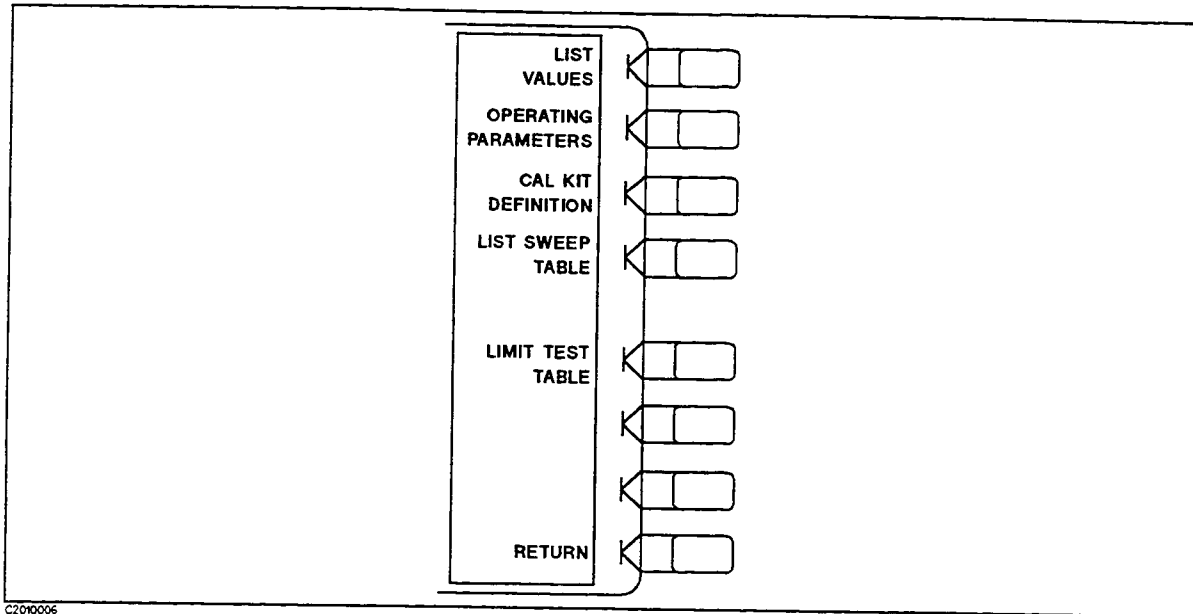

Figure 10-8. Copy More Menu

LIST VALUES (LISV) provides a tabular listing of all the measured data points and their current values, together with limit information if the limit test is ON. At the same time, the screen menu is presented to enable hard copy listings and access new pages of the table. Twenty one lines of data are listed on each page, and the number of pages is determined by the number of measurement points specified in the stimulus menu.

Table 10-3 shows data listed on the screen when **DUAL CHAN** is **OFF**. The margin listed is smaller difference value between measurement value and either upper limit or lower limit. When plus margin means the test is pass, and minus means fail.

LIST VALUES lists log magnitude values when the log magnitude format is selected as the display format, even if impedance (Z:trans, Z:refl) or admittance (Y:trans, Y:refl) is displayed using Conversion function (and markers show absolute values).

Table 10-3. List Value Format

Display Format	Column Number				
	1	2	3	4	5
LOG MAG PHASE DELAY LIN MAG SWR REAL IMAGINARY EXPANDED PHASE	Stimulus	Measurement Data ¹	Margin ²	Upper Limit Value ²	Lower Limit Value ²
SMITH CHART POLAR INV SMITH CHART LOG MAG & PHASE LOG MAG & DELAY	Stimulus	Measurement Data ¹	Measurement Data	Upper Limit Value ²	Lower Limit Value ²

1 * is displayed at the left hand of measurement value when the it fails in the limit testing.

2 This is listed when the limit test is on.

When **COUPLED CHAN** is **ON**, stimulus value is listed in the first column, measurement data of active channel are listed in the second and third columns, and non-active channel data are listed in the fourth and fifth columns. The value listed for each channel are the same as data listed in the second and third columns in Table 10-3.

If **DUAL CHAN** is **ON** and **COUPLED CH** is **OFF**, only active channel measurement data is listed.

OPERATING PARAMETERS (OPEP) provides a tabular listing on the display of the key parameters for both channels. The screen menu is presented to allow hard copy listings and access new pages of the table. Four pages of information are supplied. These pages list operating parameters, marker parameters, lists, and system parameters that relate to control of peripheral devices rather than selection of measurement parameters. The listed parameters are as follows:

- Number of points
- Sweep time
- Source power
- Port-1 and 2 attenuator
- Input R, A, and B attenuator
- IF bandwidth
- Averaging factor
- Averaging switch
- Smoothing aperture
- Smoothing switch
- Group delay aperture
- Calibration kit
- Z_0
- Calibration type
- Stimulus conditions when the calibration was performed
- Phase offset

COPY Key

- Port 1 and 2 extension
- Input R, A, and B extension
- Velocity factor
- Conjugate matching circuit and its parameters

CAL KIT DEFINITION provides the copy cal kit menu which prints/plots the calibration kit definitions.

LIST SWEEP TABLE provides a tabular listing on the display of the list sweep table.

LIMIT TEST TABLE provides a tabular listing on the display of the limit value for limit testing.

RETURN returns to the copy menu.

Copy Cal Kit Menu

This provides a tabular listing of the calibration kit definitions. The lists can be hard copied using the copy function. The elements are all the standard and class assignments.

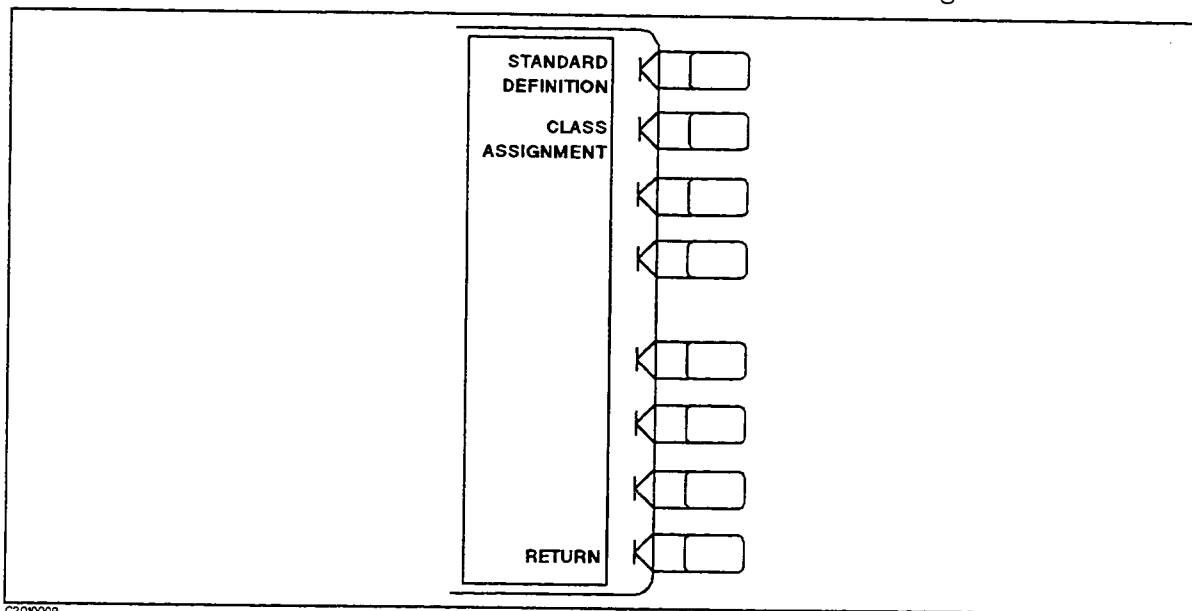

Figure 10-9. Copy Cal Kit Menu

STANDARD DEFINITION provides the copy standard number menu which selects which standard settings are to be hard copied.

CLASS ASSIGNMENT (CALCASSI) shows the tabular listing of the calibration kit class assignment, and provides the screen menu to prepare for hard copy.

RETURN returns to the copy more menu.

Copy Standard Number Menu

This selects which standard is to be hard copied.

The screenshot shows a menu with eight options, each consisting of a text label and a cursor icon (a rectangle with a vertical line and a small arrowhead on the left). The options are:

- STD NO.1
- STD NO.2
- STD NO.3
- STD NO.4
- STD NO.5
- STD NO.6
- STD NO.7
- STD NO.8

The cursor is positioned over the first option, STD NO.1.

C200013

Figure 10-10. Copy Standard Number Menu

STD NO. n (CALs) provides the tabular listing of the standard definitions of the standard number n , and provides the screen menu to prepare for hard copy.

Copy List Sweep Menu

This selects one applicable list sweep table, and defines in what format the list sweep table is to be displayed and hard copied.

The screenshot shows a menu with six options, each consisting of a text label and a cursor icon (a rectangle with a vertical line and a small arrowhead on the left). The options are:

- DISPLAY:
LIST1
- LIST2
- DISP MODE:
ST & SP
- CTR & SPAN
- NUMBER of
POINTS
- STEP SIZE
- RETURN

The cursor is positioned over the first option, DISPLAY: LIST1.

C200011

Figure 10-11. Copy List Sweep Menu

DISPLAY: LIST1 (DISL1) selects list sweep Table 1 to be displayed and hard copied.

COPY Key

LIST2 (DISL2) selects list sweep Table 2 to be displayed and hard copied.

DISP MODE: ST & SP (DISMSTSP) displays the list sweep stimulus range in terms of start and stop.

CTR & SPAN (DISMCTSP) displays the list sweep stimulus range in terms of center and span.

NUMBER of POINTS (DISMNUM) displays the list sweep stimulus resolution in terms of number of points.

STEP SIZE (DISMSTEP) displays the list sweep stimulus resolution in terms of step size.

Copy Limit Test Menu

This defines in what format the limit testing table is to be displayed and hard copied.

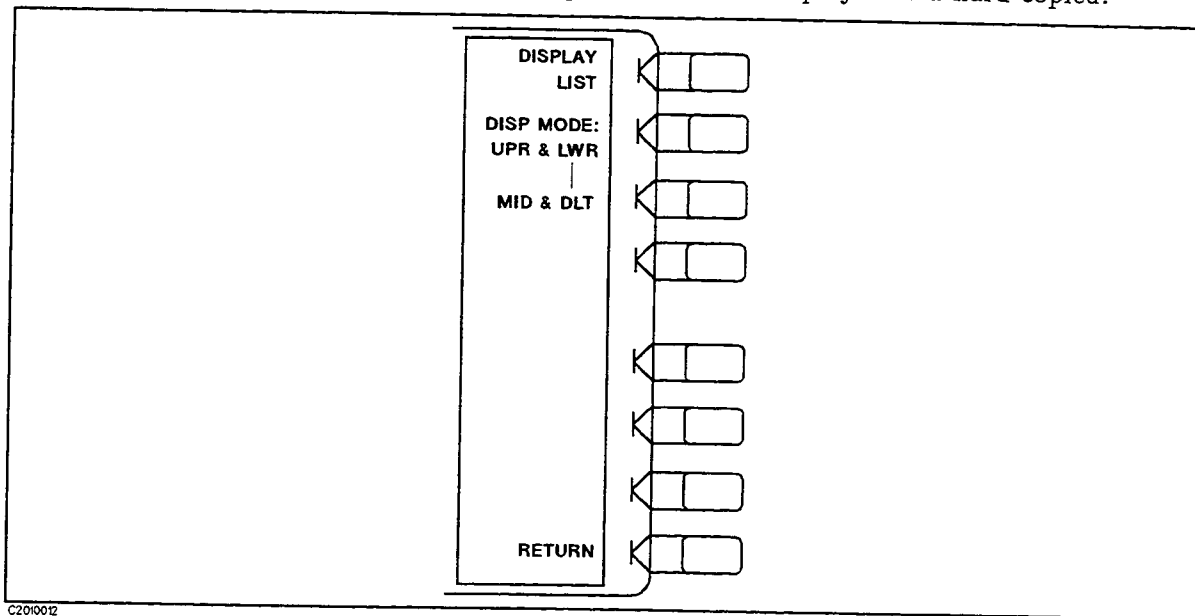

Figure 10-12. Copy Limit Test Menu

DISPLAY LIST (DISLLIST) displays the limit testing table on the display, and provides the screen menu to prepare for hard copy.

DISP MODE: UPR & LWR (DISMUL) selects the upper and lower format, which displays the limit values by upper limit and lower limit.

MID & DLT (DISMMD) selects the middle and delta format, which displays the limit values by middle value and maximum deviation (limit value) from the middle value.

Screen Menu

This menu is used in conjunction with the **LIST VALUES**, **OPERATING PARAMETERS**, **CAL KIT DEFINITION**, **LIST SWEEP TABLE**, and **LIMIT TEST TABLE** features, to make hard copy listings of the tables displayed on the screen. To make copies from the front panel, make sure that the analyzer is the system controller (see Chapter 9).

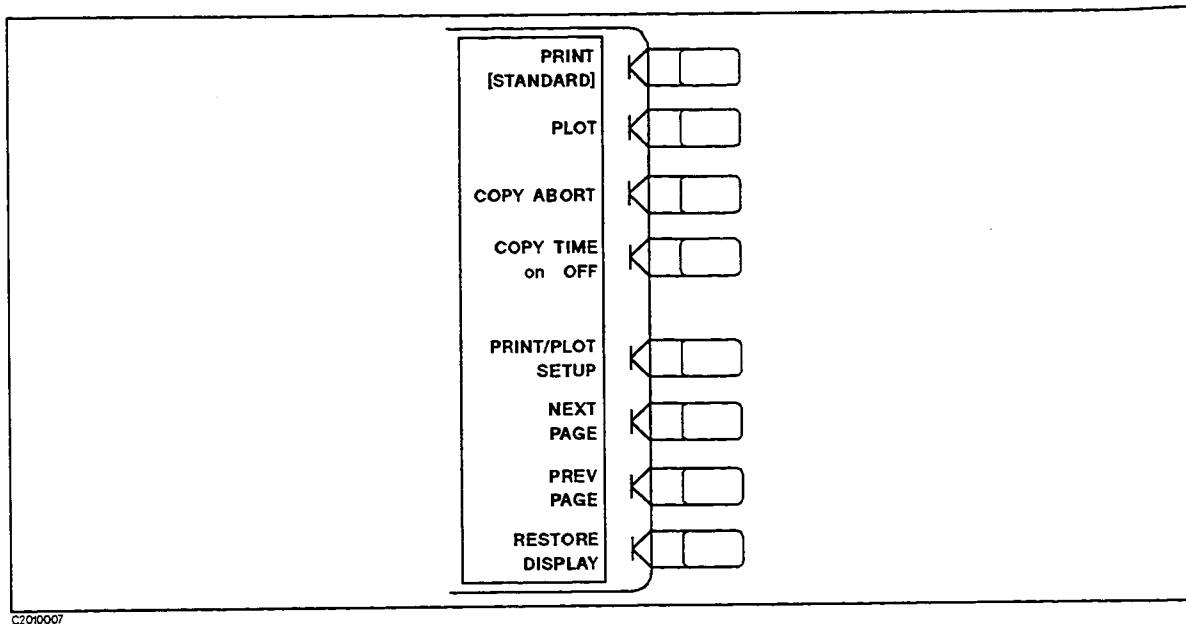

Figure 10-13. Screen Menu

PRINT [STANDARD] (PRINALL) copies one page of the tabular listings to a compatible HP graphics printer. Either **STANDARD**, for a black and white printer, or **COLOR**, for a color printer, is shown in brackets (“[]”). This identifies which printer was selected as the default in the print/plot setups menu. The default setting at power on is standard. Default text for a color printer is black.

PLOT (PLOT) plots one page of the tabular listing on the display using the current setup (defined in **SELECT QUADRANT** and **DEFINE PLOT**). Plot size and speed can be change in **DEFINE PLOT MENU** if you want.

Note Before pressing **PRINT** and **PLOT**, you must:



- set the analyzer to the system controller mode.
- make sure the analyzer’s printer HP-IB address and the printer set HP-IB address match.

COPY ABORT (COPA) aborts a plot or print in progress.

COPY TIME on OFF (COPTON, COPTOFF) turns printing or plotting time and date ON or OFF. When you select print, the time and date are printed first, then the information displayed on display. When you select plot, time and date are plotted just below the title area. Refer to “**SYSTEM KEY**” in Chapter 9 for setting the internal clock.

COPY Key

PRINT/PLOT SETUPS presents the print/plot setups menu. This menu provides menu to set a graphics printer and plotter.

NEXT PAGE (NEXP) displays the next page of information in a tabular listing onto the display.

PREV PAGE (PREP) displays the previous page of information in a tabular listing onto the display.

RESTORE DISPLAY (RESD) turns off the tabular listing and returns the measurement display to the screen.

Configure Plot Menu

This menu is used to select the pens to be used for plotting different elements of a plot.

Pen numbers 0 through 6 can be selected (0 indicates no pen). It is possible to select a pen number higher than the number of pens in the plotter used. The convention in most Hewlett-Packard plotters is that when the pen number count reaches its maximum number it starts again at 1. Thus in a 4-pen plotter, pen number 5 actually calls pen number 1.

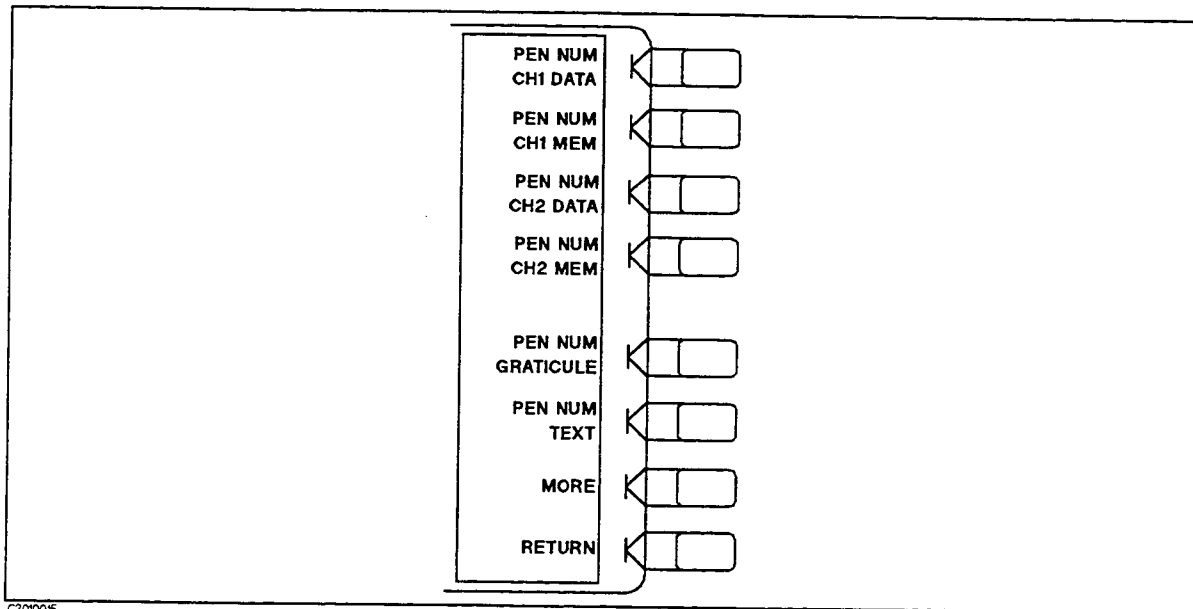

Figure 10-14. Configure Plot Menu

PEN NUM CH1 DATA (PENNCH1DATA) selects the number of the pen number of the pen to plot the data trace of channel 1. The default pen is pen number 1.

PEN NUM CH1 MEM (PENNCH1MEM) selects the number of the pen to plot the memory trace of channel 1. The default pen is 5.

PEN NUM CH2 DATA (PENNCH2DATA) selects the number of the pen to plot the data trace for channel 2. The default pen is 2.

PEN NUM CH2 MEM (PENNCH2MEM) selects the number of the pen to plot the memory trace for channel 2. The default pen is 6.

PEN NUM GRATICULE (PENNGRAT) selects the number of the pen to plot the graticule. The default pen is 3.

PEN NUM TEXT (PENNTXT) selects the number of the pen to plot the text. The default pen is 4.

MORE leads to the configure plot more menu. This key appears only when the analyzer is equipped with Instrument BASIC (Option 002).

RETURN goes back to the copy menu.

Configure Plot More Menu

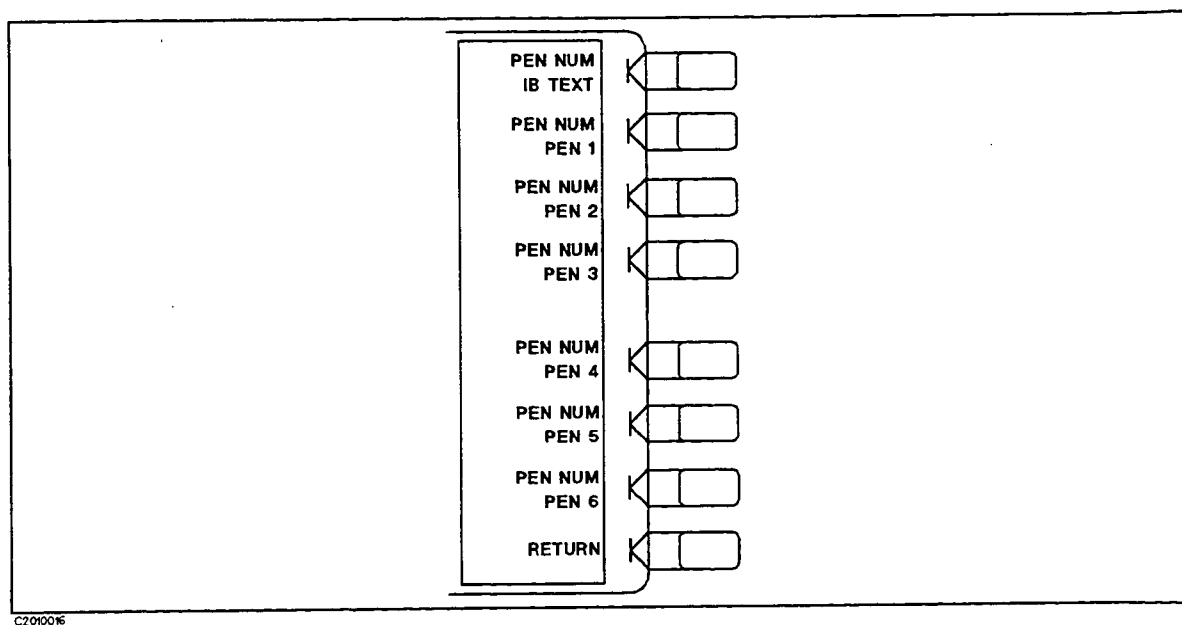

Figure 10-15. Configure Plot More Menu

PEN NUM IB TEXT (PENNIBTEXT) selects the number of the pen to plot the text in the HP Instrument BASIC screen. The default pen is 4.

PEN NUM PEN 1 (PENNIBPEN1) selects the number of the pen to plot the pen 1 used by the HP Instrument BASIC graphic commands. The default pen is 1.

PEN NUM PEN 2 (PENNIBPEN2) selects the number of the pen to plot the pen 2 used by the HP Instrument BASIC graphic commands. The default pen is 2.

PEN NUM PEN 3 (PENNIBPEN3) selects the number of the pen to plot the pen 3 used by the HP Instrument BASIC graphic commands. The default pen is 3.

PEN NUM PEN 4 (PENNIBPEN4) selects the number of the pen to plot the pen 4 used by the HP Instrument BASIC graphic commands. The default pen is 4.

PEN NUM PEN 5 (PENNIBPEN5) selects the number of the pen to plot the pen 5 used by the HP Instrument BASIC graphic commands. The default pen is 5.

COPY Key

PEN NUM PEN 6 (PENNIBPEN6) selects the number of the pen to plot the pen 6 used by the HP Instrument BASIC graphic commands. The default pen is 6.

RETURN goes back to the configure plot menu.

Saving and Recalling Instrument States and Data

INTRODUCTION

This chapter describes how to save and recall instrument states and data for later retrieval using the built-in disk drive.

Brief tutorial information on saving and recalling instrument states is provided in the *User's Guide*.

This chapter explains the following:

- What information is saved
- **SAVE**, **RECALL** key menu description

Note



The **SAVE** and **RECALL** keys do not access Instrument BASIC programs. Instrument BASIC has its own menus (under **SYSTEM** key) for accessing the built-in disk drive. Refer to "INSTRUMENT BASIC (Option 002)" in Chapter 9 for detail.

STORAGE DEVICES

The analyzer supports two storage devices, a built-in flexible disk drive and a RAM disk memory. The flexible disk drive is suited to storing large numbers of files and long term data storage. RAM disk is suited to storing tentative data and instrument states and to store or get data quickly.

Note



Use the built-in flexible disk to store important data, because the RAM disk data is lost when the power to the RAM disk memory is lost for more than 72 hours. The operating time of the battery backup for RAM disk memory is approximately 72 hours after the analyzer is turned OFF.

RAM Disk Memory Capacity

The RAM disk memory capacity is 63 kbytes which includes the directory area. The capacity of data area depends on the disk format type. The following table shows the capacity of the data area by disk formats:

RAM Disk Memory Capacity

LIF Format	DOS format
58.75 kbyte	58 kbyte

File Types and Data Saved

Operating Time of the Battery Backup for RAM Disk Memory

The operating time of the battery backup for RAM disk memory is approximately 72 hours after the analyzer is turned OFF.

Copy Files Between the RAM Disk and the Flexible Disk

A copy function is provided to copy files between the RAM disk and the flexible disk. **FILE UTILITIES** in the SAVE menu leads the softkey to copy files. The HP-IB command "file" is also available to copy files.

Note



Use the same disk format type between the RAM disk and the flexible disk when you copy files using this function. This copy function can not copy files when the format type of the RAM disk is different from the format of the flexible disk.

FILE TYPES AND DATA SAVED

Binary Files and ASCII Files

The analyzer supports two file formats, binary and ASCII, in which to save data on a disk. Binary files are used to save measurement conditions and data using the SAVE function, and to retrieve binary data using the RECALL function. External controllers and Instrument BASIC can read measurement data from binary data files. ASCII measurement data or screen image files can be read by commonly available IBM PC based software for data analysis or other secondary functions. The RECALL function can NOT read ASCII files.

Note



ASCII data files can not be recalled on the HP 8751A. If you need to recall the data, save the file in binary format. This binary data can be recalled and saved as an ASCII file at any time.

Data Groups

You can select and save one of the following five combinations between two file types and four data groups to a disk.

- Binary File
 - Instrument states
 - Internal data arrays
 - Instrument states and internal data arrays
- ASCII File
 - Internal data arrays (ASCII format)
 - Graphics image

Note

DATA ONLY does not save the instrument settings such as start and stop frequencies. BE CAREFUL! Always make that you save ALL for your first measurement with a particular setting.

Instrument States

The instrument state group consists of all front panel settings and the calibration coefficient arrays. This data group can retrieve identical measurement conditions for later use.

Internal Data Arrays

The internal data arrays which are essentially stored in the analyzer's memory consists of the following seven data arrays. Refer to "DATA PROCESSING" in Chapter 1 for complete information on each data array and their relationships.

- *Raw data arrays* hold raw, uncalibrated measurement data.
- *Calibration Coefficients arrays* hold the expanded calibration coefficients obtained by calibration.

Note

The calibration coefficient arrays described in "Instrument States" and in this section differ. The later is processed data, for example interpolated, while the earlier is raw data.

- *Data arrays* hold the calibrated data using the calibration coefficients.
- *Memory arrays* hold the memorized data arrays using the DATA→MEM operation.
- *Unformat arrays* hold the last processed complex number pairs.
- *Trace arrays* hold the formatted data. This is identical with the "format arrays" described in "DATA PROCESSING" in Chapter 1.
- *Memory trace arrays* hold the formatted data of the "memory arrays".

These arrays can be saved selectively to suit the application. For example, when measuring a number of devices with the same measurement settings, you may need to save only the *trace arrays* for each device.

Saving only the necessary arrays reduces the disk space required and the disk access time.

In addition, saving internal data also allows the analysis of the measurement results using an external controller. Refer to "File Structure of Internal Data Arrays File for Binary Files" for more information.

Instrument States and Internal Data Arrays

These consist of the instrument states which includes raw calibration coefficients, the data arrays, and memory arrays. However, saving and retrieving the complete states and data, occupies a lot of disk space.

Additional Information

Internal Data Arrays (ASCII file)

The internal data arrays saved in an ASCII file consists of the same seven data arrays as saved in a binary file.

Graphics

Graphics consists of graphic images on the screen created using HP-GL (Hewlett-Packard Graphics Language). The HP-GL format is supported by most drawing software, and is the format used by most plotters.

ADDITIONAL INFORMATION

Disk Requirements

The analyzer disk drive uses a 720 k, or 1.44 Mbyte 3.5 inch micro-flexible disk. Refer to the "System Accessories Available" section in *General Information* for disk part numbers.

Disk Formats

The analyzer's built in disk drive can access both LIF (logical interchange format) and DOS formatted disks. The disk drive can also initialize a new disk in either LIF or DOS format.

The following list shows the applicable DOS formats for the HP 8751A.

- 720 kbyte, 80 tracks, double-sided, 9 sectors/track
- 1.44 Mbyte, 80 tracks, double-sided, 18 sectors/track

File Names

All data saved using the built in disk drive has an identifying file name. A file name consists of the lower and upper case alphabet, numbers, and valid symbol characters. Up to 8 characters can be used for a file name. The following table shows the valid characters for LIF and DOS file names.

Table 11-1. Valid Characters for File Names

Valid Characters		Description
LIF	DOS Format	
A - Z	A - Z	Upper case alphabet
a - z	a - z	Lower case alphabet
0 - 9	0 - 9	Numeric characters
-	\$ & # % ' ! () - _ @ ^ { } ~	Symbol characters

One of the following suffixes or extensions is automatically added to the file name depending on the data group type stored in the file.

Table 11-2. Suffixes and Extensions Added Automatically

Data Groups	Suffixes for LIF	Extensions for DOS
Instrument States (STATE ONLY)	_S	.STA
Internal Data Arrays (DATA ONLY (binary))	_D	.DTA
Instrument States And Internal Data Arrays (ALL)	_A	.ALL
Internal Data Arrays as an ASCII File (DATA ONLY (ASCII))	_I	.TXT
Graphics Image as an HP-GL File (GRAPHICS)	_G	.HPG

Auto Recall Function

When the analyzer is turned on, it looks for a file named "AUTOREC" from the built-in flexible disk, and if found, the analyzer automatically reads the file to retrieve its data. If the analyzer does not find the file, the analyzer looks for the file from RAM disk.

File Size

The maximum number of files that can be saved on a disk depends on the disk capacity and the total size of the files to be saved. The file size depends on the analyzer settings, such as number of points, calibration type, etc.

Table 11-3 shows the approximate file sizes (in bytes) of binary files versus the number of points when the default settings are stored.

Table 11-3. File Size Versus Number of Points (binary files)

Number of Points	State only	Data only							All
		Raw Data	Cal	Data	Memory	Unformat	Trace	Memory Trace	
201	2 k	26 k	77.5 k	6.5 k	6.5 k	6.5 k	6.5 K	6.5 k	6 k
401	2 k	51.5 k	154 k	13 k	13 k	13 k	13 k	13 k	9 k
801	2 k	102.5 k	308 k	26 k	26 k	26 k	26 k	26 k	16 k

Table 11-4 shows the approximate file sizes (in bytes) of ASCII files versus the number of points when the default setting is stored.

Table 11-4. File Size Versus Number of Points (ASCII files) 1/2

Number of Points	Data only					
	Raw Data	Data	Memory	Unformat	Trace	Memory Trace
201	8.3 k ¹	8.3 k	8.3 k	8.3 k	8.3 k	8.3 k
401	16.5 k ¹	16.5 k	16.5 k	16.5 k	16.5 k	16.5 k
801	33 k ¹	33 k	33 k	33 k	33 k	33 k

1 When 2-port calibration is used, file size will be three times larger.

Additional Information

Table 11-5 lists the approximate file sizes (in bytes) versus the number of points when calibration data is saved in an ASCII file with each calibration type turn on.

Table 11-5. File Size Versus Number of Points (ASCII files) 2/2

Number of Points	Calibration Data only				
	Correction Off	Response	Response and Isolation	1 Port Calibration	2 Port Calibration
201	2.8 k	8 k	13.5 k	19 k	68 k
401	5.6 k	16 k	27 k	38 k	135 k
801	11 k	32 k	54 k	76 k	270 k

File Structure of Internal Data Arrays File for Binary Files

Note Binary and ASCII file structures are not compatible.



When internal data arrays are saved as a binary file, the arrays' file consists of a file header at the top of the file and the data groups following the file header.

Refer to *HP-IB Programming Manual* for an example BASIC program you can use to access the data.

File Header

Every internal data array file begins with a file header. Figure 11-1 shows the header structure.

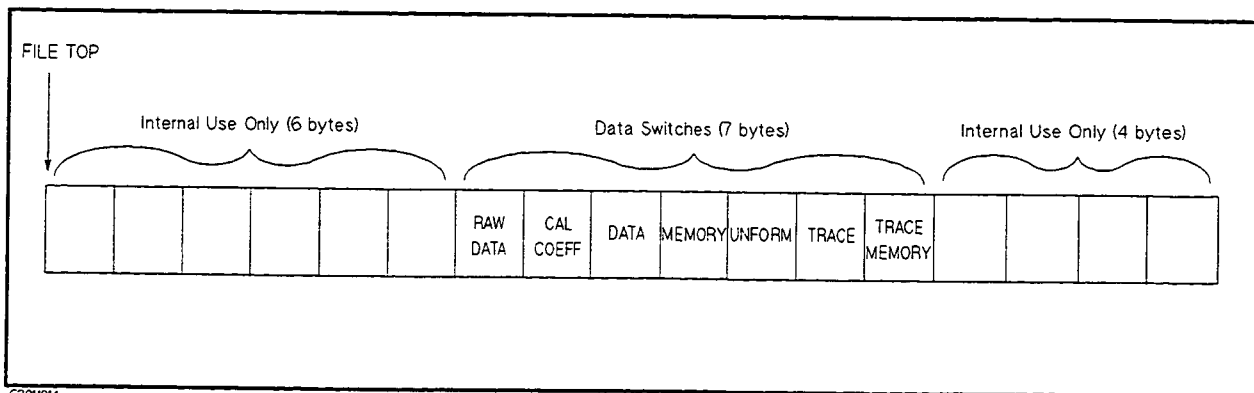

Figure 11-1. File Header Structure

Seven data switches define which data groups follow the file head. Each one-byte switch is either 1 or 0 (decimal value) if the applicable data group exists or not, respectively. The data group to be followed is in the same order of these switches. For example, when the data switches, RAW and TRACE are 1 (ON), while the others are OFF, only the RAW and TRACE (in this order) groups will follow the header.

11-6 Saving and Recalling Instrument States and Data

Data Group

Every data group consists of the same structured data segments. The number of data segments depends on the data group type as follows:

- *RAW DATA* consists of eight data segments as shown in Figure 11-2. They will follow the file header in this order.

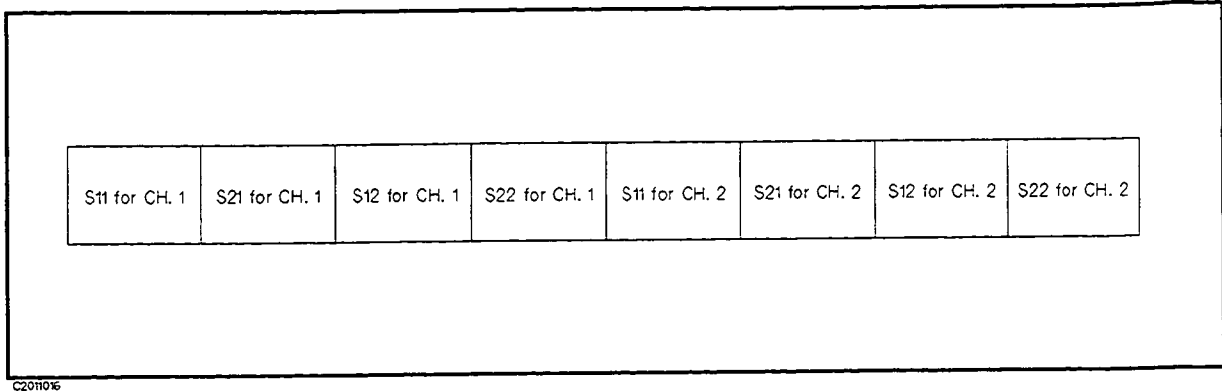

Figure 11-2. RAW Data Group Structure

- *CAL* consists of 24 data segments as shown in Figure 11-3. The first half of the segments are for channel 1, and the second half of the segments are for channel 2. The contents of each segment depends on the type of calibration performed. (Refer to Chapter 7.)

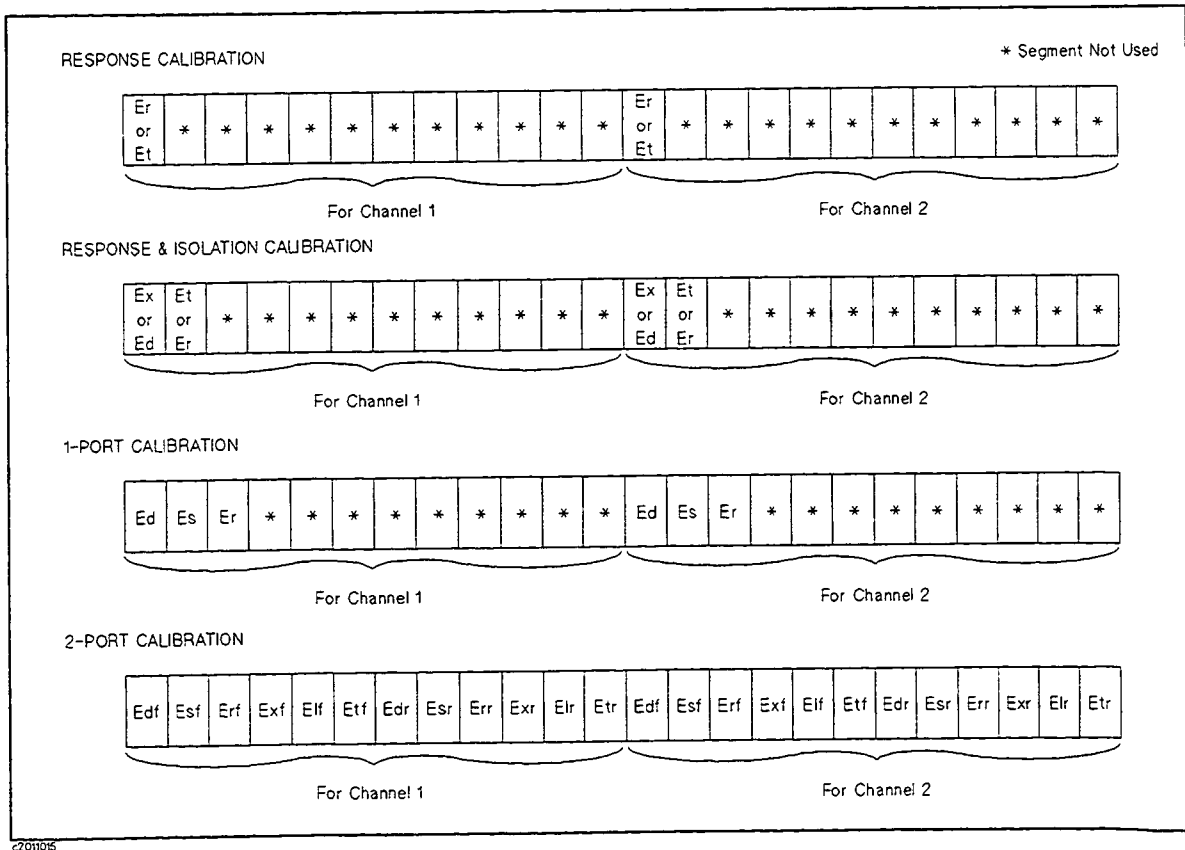

Figure 11-3. CAL Data Group Structure

11: Saving and Recalling

Additional Information

- *DATA* consists of two data segments.
- *MEMORY* consists of two data segments.
- *UNIFORM* consists of two data segments.
- *TRACE* consists of two data segments.
- *TRACE MEMORY* consists of two data segments.

Data Segment

The data segment structure is as shown in Figure 11-4.

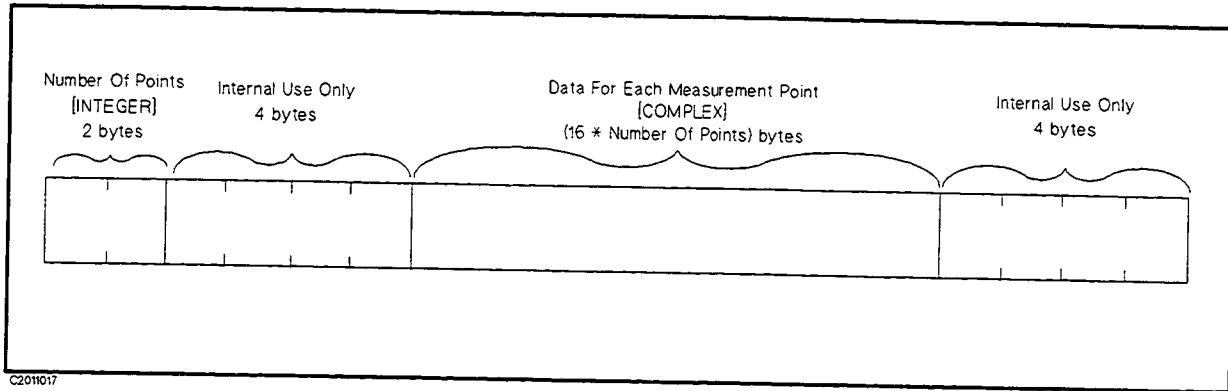

Figure 11-4. Data Segment

- *Number Of Points (NOP)* is a two-byte INTEGER value. This number is equal to the number of complex data which follows.
- *DATA* is a set of the values for each measurement point. The values are two IEEE 754 double precision floating numbers (first value as real part, second value as imaginary part). The data size in bytes can be determined by $16 \times \text{NOP}$.

File Structure of Internal Data Arrays File for ASCII File

Numerical data and strings in an ASCII data file are separated by a tab, and a string is bound by double quotation marks.

Status Block and Data Block

An ASCII data file consists of a status block and data blocks. The status block consists of two lines, the revision number and the date code. The Data block consists of three parts, the state part, the title line, and the data part.

■ State

The state part consists of the following instrument states:

- Channel number
- Title on the screen
- Measurement type
- Format type
- Number of points
- Sweep time
- Sweep type
- Source power or CW frequency

- IF bandwidth
- Title

The title part consists of the data array names saved. Data array names are described in the next section.

- Data

The data part consists of stimulus and measurement numerical data.

Table 11-6 shows an example of an ASCII data file.

Table 11-6. Contents of ASCII Files

Block Names		Contents
Status Block		"8751A REV4.00" "DATE: Apr 21 1991" ¹
Data Block	State	"CHANNEL: 1" "TITLE: This is a title." ² "MEAS TYPE: A/R" "FORMAT TYPE: LOG MAG" "NUMBER of POINTS: 201" "SWEEP TIME: 12.2 ms" "SWEEP TYPE: LIST FREQ" "SOURCE POWER: 0 dBm" ³ "IF BANDWIDTH: 4 kHz"
	Title	"Frequency"→"Raw [S11] Real"→"Raw [S11] Imag"→... ^{4,5}
	Data ⁶	3.00000E+5→8.20007E-1→4.09729E-1→... ⁴ 1.52238E+7→9.32143E-1→-4.1914E-2→... : :

- 1 This is the date when the file is saved.
- 2 This line is listed when the title is defined (displayed).
- 3 Shows the power level of the source for a frequency sweep. If power sweep is selected, the CW frequency is listed (for example "CW FREQ: 100 MHz").
- 4 "→" means tab code. Data is separated by the tab code.
- 5 This line lists the names of the data array saved in this file. Titles used in the ASCII files are shown in Table 11-5 through Table 11-9.
- 6 Each line lists the measurement data at each measurement point. The number of Lines in the data block is the same as the number of points.

Additional Information

File Structure for Single Channel and Dual Channel

If you save an ASCII file when DUAL CHANNEL is turned OFF, the ASCII data file consists of the active channel's data. If DUAL CHANNEL is turned ON, the ASCII data file consists of the data of both channels 1 and 2. The channel 2 data follows the channel 1 data as follows:

File Structures for Single and Dual Channels

Dual Channel OFF	Dual Channel ON
Status Block	Status Block
Data Block of Active Channel	Data Block of Channel 1
(end of file)	Data Block of Channel 2

Data Array Names

Data array names are used in the title line of the data block. Each real and imaginary part of the internal data array has one name, Table 11-7 lists all names.

Table 11-7. Data Groups and Data Array Names

Data Groups	Data Array Names		Descriptions
	Real Part	Imaginary Part	
Raw Data	Raw[S11] Real	Raw[S11] Imag	Raw data arrays for S11 meas.
	Raw[S21] Real	Raw[S21] Imag	Raw data arrays for S21 meas.
	Raw[S12] Real	Raw[S12] Imag	Raw data arrays for S12 meas.
	Raw[S22] Imag	Raw[S22] Imag	Raw data arrays for S22 meas.
Calibration Data ¹	Cal[1] Real	Cal[1] Imag	Er, ² Et, ² Ex, ³ Ed, ^{3,4} or Edf ⁵
	Cal[2] Real	Cal[2] Imag	Et, ³ Er, ³ Es, ⁴ or Esf ⁵
	Cal[3] Real	Cal[3] Imag	Er ⁴ or Erf ⁵
	Cal[4] Real	Cal[4] Imag	Exf ⁵
	Cal[5] Real	Cal[5] Imag	Elf ⁵
	Cal[6] Real	Cal[6] Imag	Etf ⁵
	Cal[7] Real	Cal[7] Imag	Edr ⁵
	Cal[8] Real	Cal[8] Imag	Esr ⁵
	Cal[9] Real	Cal[9] Imag	Err ⁵
	Cal[10] Real	Cal[10] Imag	Exr ⁵
	Cal[11] Real	Cal[11] Imag	Elr ⁵
	Cal[12] Real	Cal[12] Imag	Etr ⁵
Data	Data Real	Data Imag	Corrected Data arrays
Memory	Memory Real	Memory Imag	Corrected Memory arrays
Unformat	Unform Real	Unform Imag	Unformat Data arrays
Trace	Trace Real	Trace Imag	Trace (format) arrays
Memory Trace	Trace Memory Real	Trace Memory Imag	Trace (format) memory arrays

¹ For more information on calibration, refer to "Appendix to Chapter 7"

² When response calibration is used.

³ When response and isolation calibration are used.

⁴ When 1 port calibration is used.

⁵ When 2 port calibration is used.

Data Groups

Every data group consists of data arrays. The number of data arrays depend on the data group types. The saved data arrays RAW and CAL depend on the instrument state.

- RAW DATA consists of eight data arrays. The data arrays saved depend on the calibration type and the measurement type. If RAW DATA is saved in an ASCII data file when 2-port calibration is used, all eight RAW data arrays will be saved in the ASCII data file for any measurement type. If another calibration type is used, the data arrays saved depend on the measurement type. Table 11-8 lists the RAW data array combinations, which are saved for each measurement type selected.

Additional Information

Table 11-8. Measurement Type Versus Raw Data Saved

Measurement Type	Raw Data Arrays Saved ¹
A/R	"Raw[S11] Real", "Raw[S11] Imag"
B/R	"Raw[S21] Real", "Raw[S21] Imag"
A/B	"Raw[S12] Real", "Raw[S12] Imag"
A	"Raw[S11] Real", "Raw[S11] Imag"
B	"Raw[S21] Real", "Raw[S21] Imag"
R	"Raw[S12] Real", "Raw[S12] Imag"
Bdc	"Raw[S22] Real", "Raw[S22] Imag"
Bdc/R	"Raw[S22] Real", "Raw[S22] Imag"
S11	"Raw[S11] Real", "Raw[S11] Imag"
S12	"Raw[S12] Real", "Raw[S12] Imag"
S21	"Raw[S21] Real", "Raw[S21] Imag"
S22	"Raw[S22] Real", "Raw[S22] Imag"

¹ When 2-port calibration is turned ON, all Raw Data is saved.

- CAL DATA consists of twenty data arrays. The data arrays saved depend on the calibration type used. Table 11-9 lists the CAL data arrays, which are saved for each calibration type selected.

Table 11-9. Calibration Type Versus CAL Data Saved

Calibration Type	CAL Data Saved	Error Terms ¹
Response	"Cal[1] Real", "Cal[1] Imag"	Er or Et
Response and Isolation	"Cal[1] Real", "Cal[1] Imag"	Ex or Ed
	"Cal[2] Real", "Cal[2] Imag"	Et or Er
1 port Calibration	"Cal[1] Real", "Cal[1] Imag"	Ed
	"Cal[2] Real", "Cal[2] Imag"	Es
	"Cal[3] Real", "Cal[3] Imag"	Er
2 port Calibration	"Cal[1] Real", "Cal[1] Imag"	Edf
	"Cal[2] Real", "Cal[2] Imag"	Esf
	"Cal[3] Real", "Cal[3] Imag"	Erf
	"Cal[4] Real", "Cal[4] Imag"	Exf
	"Cal[5] Real", "Cal[5] Imag"	Elf
	"Cal[6] Real", "Cal[6] Imag"	Etf
	"Cal[7] Real", "Cal[7] Imag"	Edr
	"Cal[8] Real", "Cal[8] Imag"	Esr
	"Cal[9] Real", "Cal[9] Imag"	Err
	"Cal[10] Real", "Cal[10] Imag"	Exr
	"Cal[11] Real", "Cal[11] Imag"	Elr
	"Cal[12] Real", "Cal[12] Imag"	Etr

¹ For more information on error terms, refer to "Appendix to Chapter 7"

- DATA consists of two data arrays.

- MEMORY consists of two data arrays.
- UNFORM consists of two data arrays.
- TRACE consists of two data arrays.
- TRACE MEMORY consists of two data arrays.

SAVE AND **RECALL** KEYS

The HP-IB programming command is shown in parenthesis following the key or softkey.

The **SAVE** key provides access to all the menus used for saving instrument states and data on the disk. This includes the menus used to define titles for disk files, to define the content of disk files, to initialize disks for storage, and to purge files from a disk.

The **RECALL** key leads to the menus that recall the contents of disk files back into the analyzer.

Caution



NEVER remove a disk from the disk drive, when the drive is accessing the disk. During disk access, the yellow LED on the drive lights.

SAVE and **RECALL** Keys

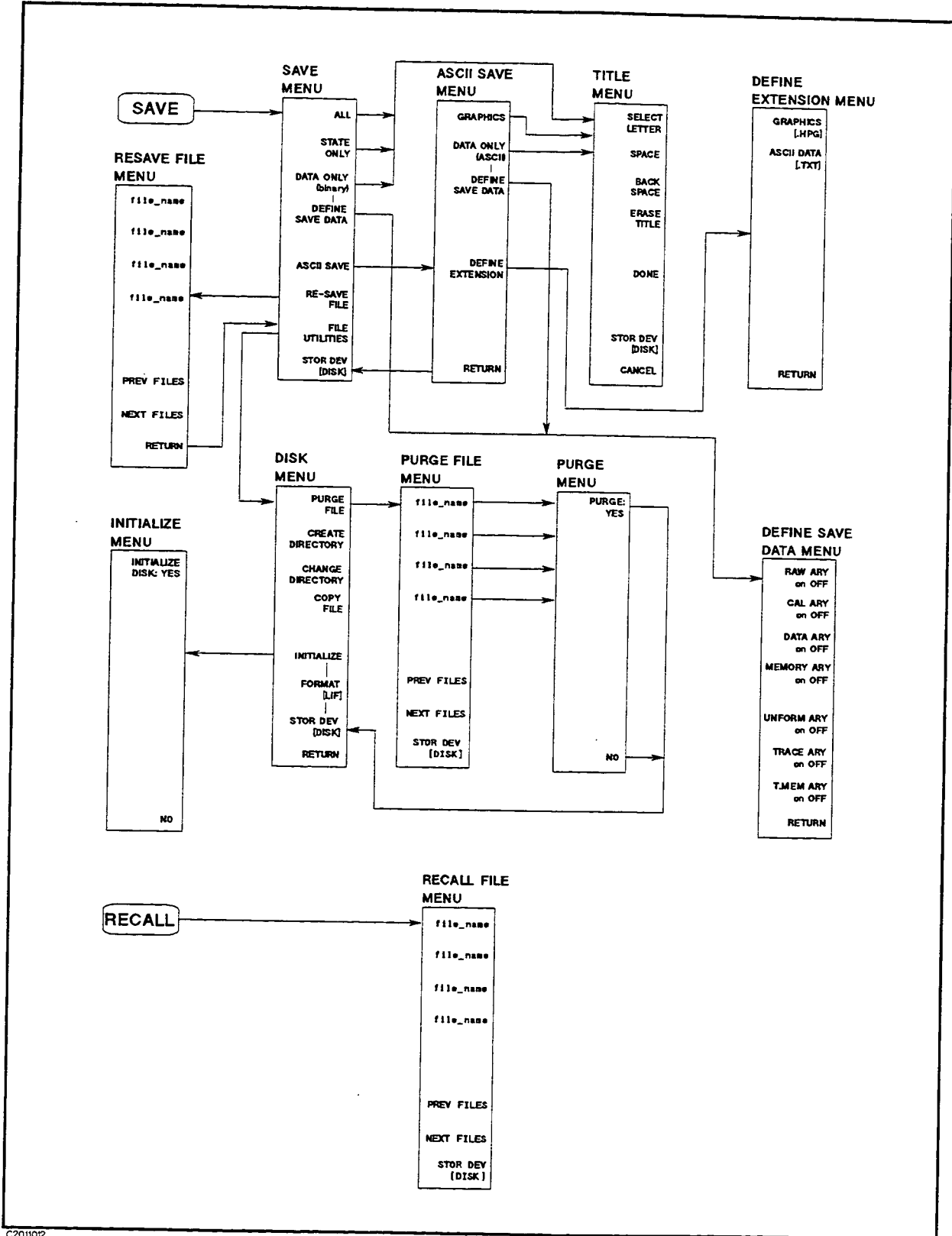

Figure 11-5. Softkey Menus Accessed from the **SAVE** and **RECALL** Keys

Save Menu

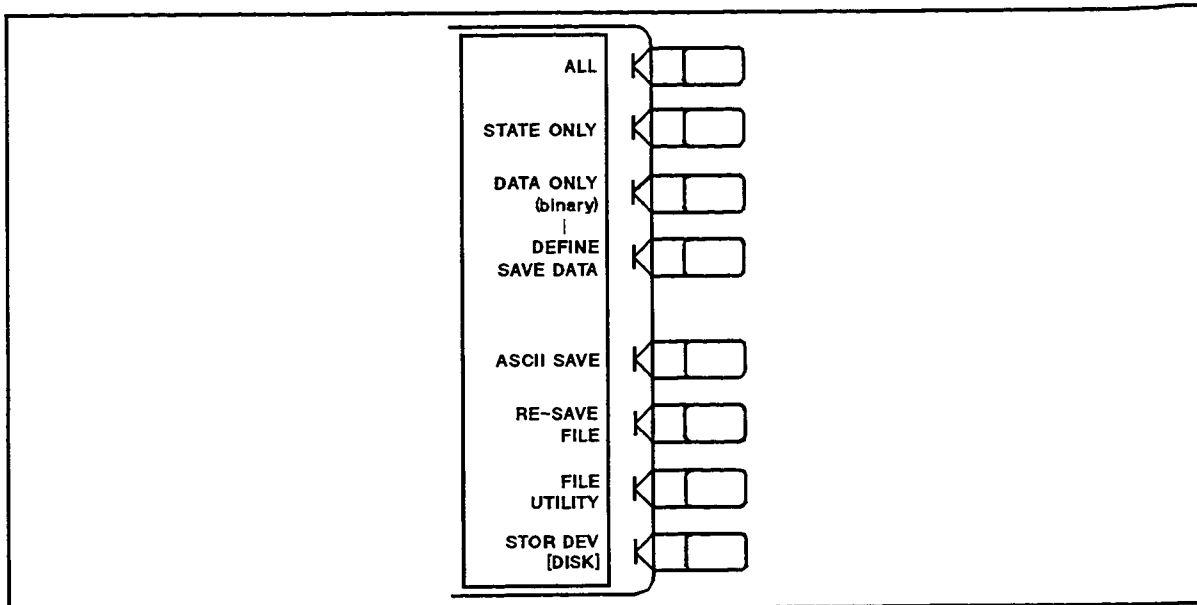

Figure 11-6. Save Menu

ALL (SAVDAL) specifies saving the instrument states, the “data arrays”, and the “memory arrays”.

STATE ONLY (SAVDSTA) specifies saving only the instrument states and the calibration coefficients.

DATA ONLY (binary) (SAVDDAT) specifies saving the internal data arrays which are defined using the **DEFINE SAVE DATA** key.

DEFINE SAVE DATA provides the define save data menu, which selects the applicable data arrays to be saved.

ASCII SAVE leads to the ASCII Save Menu, from which to save data or graphic screen images to an ASCII file.

RE-SAVE FILE (RESAVD) leads to the Re-save File menu, to update a file which is already saved.

FILE UTILITIES provides the disk menu, which initializes a new disk, and purges a file from a disk.

STOR DEV (STODDISK STODMEMO) selects between the flexible disk drive and the RAM disk memory as the storage device. **[DISK]** shows the built-in flexible disk is selected and **[MEMORY]** shows the RAM disk memory is selected. This setting does not change even when the line power is cycled or the **PRESET** key is pressed.

SAVE and **RECALL** Keys

Title Menu

This menu defines the file name to be saved.

The file name can be up to eight characters long, alphabetic (upper and lower case), numeric, special characters, see Table of Valid Characters in the file names section. If more than eight characters are entered, the last character is over written each time you type in a character.

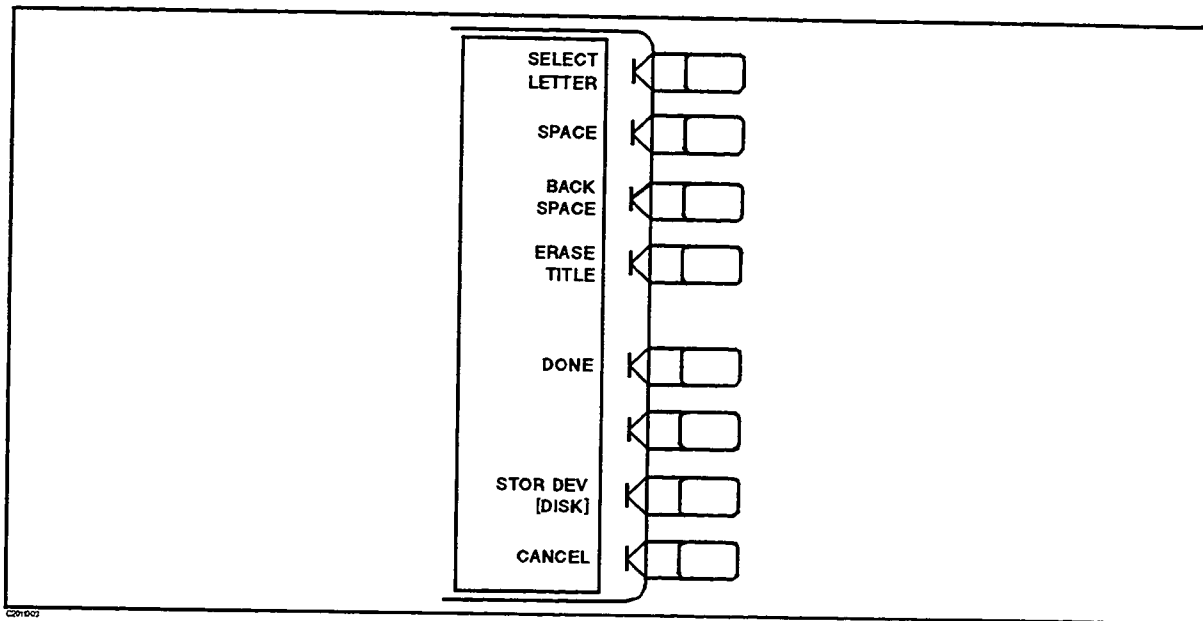

Figure 11-7. Title Menu

SELECT LETTER The active entry area displays the letters of the alphabet, numerals, etc. To define a title, rotate the knob until the arrow ↑ points to the desired letter, then press **SELECT LETTER**. Repeat this procedure until the file name is defined, for a maximum of eight characters.

SPACE Don't use this key because LIF and DOS file formats don't allow spaces in file names.

BACK SPACE deletes the last character entered.

ERASE TITLE deletes the entire file name.

DONE saves the data specified in the define save menu and returns to the Save menu.

STOR DEV [] (STODISK STODMEMO) selects between the flexible disk drive and the RAM disk memory as the storage device. [DISK] shows the built-in flexible disk is selected and [MEMORY] shows the RAM disk memory is selected. This setting does not change even when the line power is cycled or the **PRESET** key is pressed.

CANCEL quits this menu without saving the file, and returns to the Save menu.

ASCII Save Menu

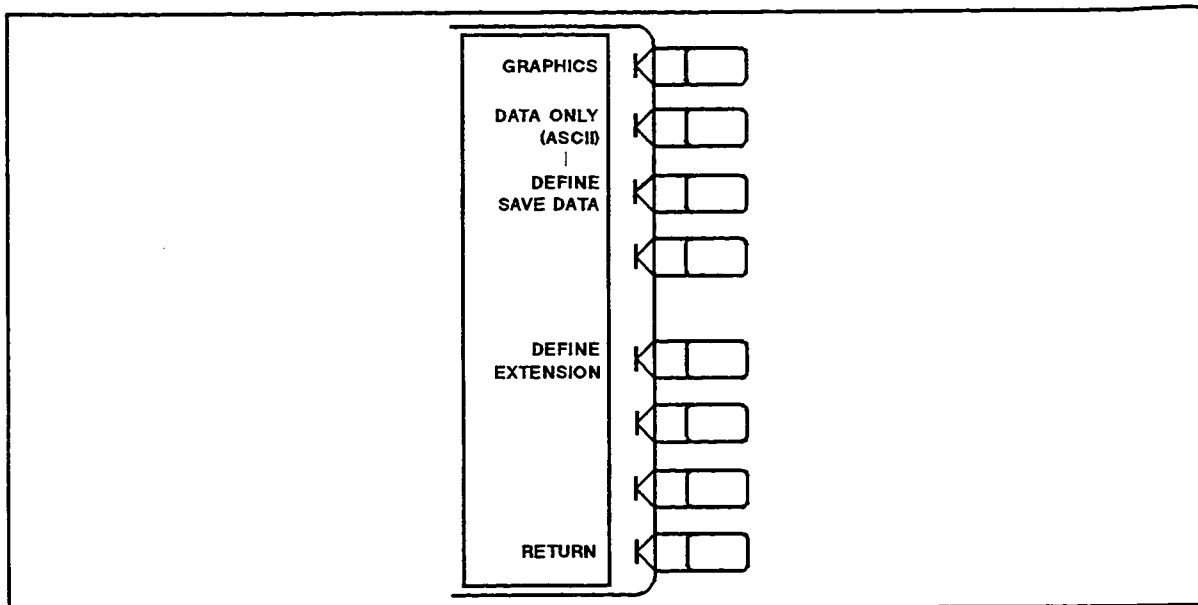

Figure 11-8. ASCII Save Menu

GRAPHICS (SAVDGRA) specifies saving the graphics image on the screen as an HP-GL file. The graphics portion saved is selected in the define plot menu under the **COPY** key. (Refer to Chapter 10.)

DATA ONLY (ASCII) (SAVDASC) specifies saving the internal data arrays as an ASCII file. The arrays saved are defined by the **DEFINE SAVE DATA** key.

DEFINE SAVE DATA provides the define save data menu, which selects the applicable data arrays to be saved.

DEFINE EXTENSION provides the define extension menu, which changes the file extensions of ASCII files.

RETURN returns to the Save menu.

SAVE and **RECALL** Keys

Define Extension Menu

DOS format ASCII default file extensions are changed from this menu. The analyzer stores the changed extensions in its battery backed memory, the changed extensions are saved even when the instrument is turned off.

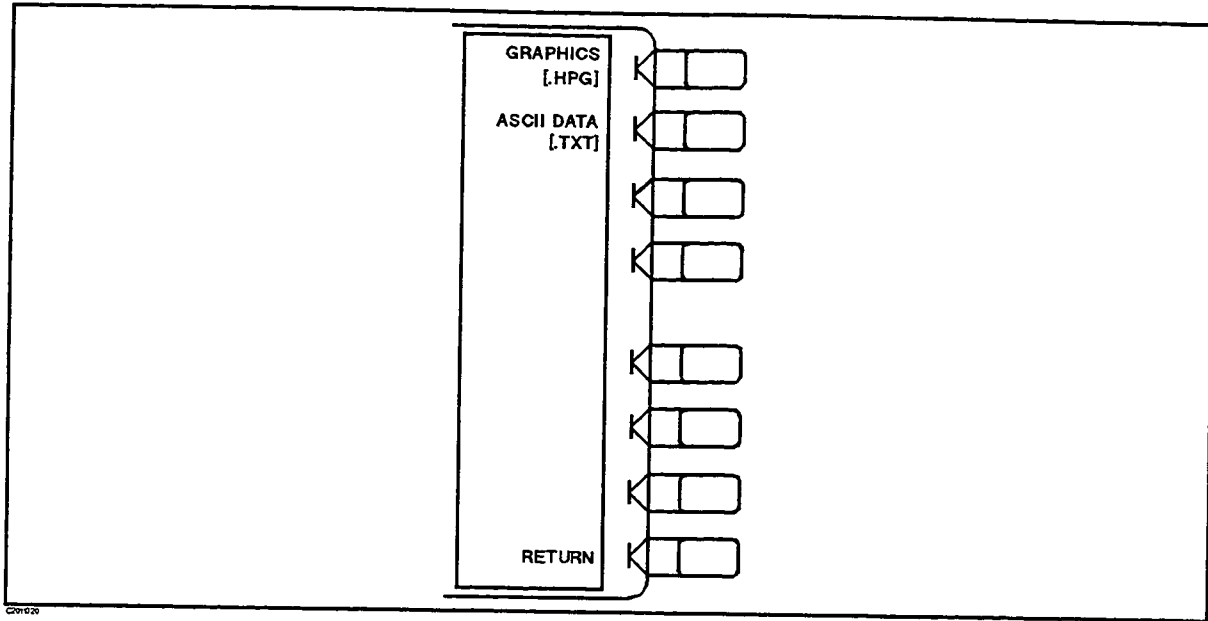

Figure 11-9. Define Extension Menu

GRAPHICS [] (GRAE) changes the extension of HP-GL files for DOS format. The extension is automatically attached to the file name when an HP-GL file is saved. The factory setting is ".HPG".

ASCII DATA [] (ASCE) changes the extension of an ASCII data file for DOS format. The extension is automatically attached to the file name when an ASCII data file is saved. The factory setting is ".TXT".

RETURN returns to the ASCII Save menu.

Define Save Data Menu

This menu defines which data arrays are saved on the disk using the **SAVE DATA ONLY** softkey. Refer to "Internal Data Arrays" for description of each data arrays.

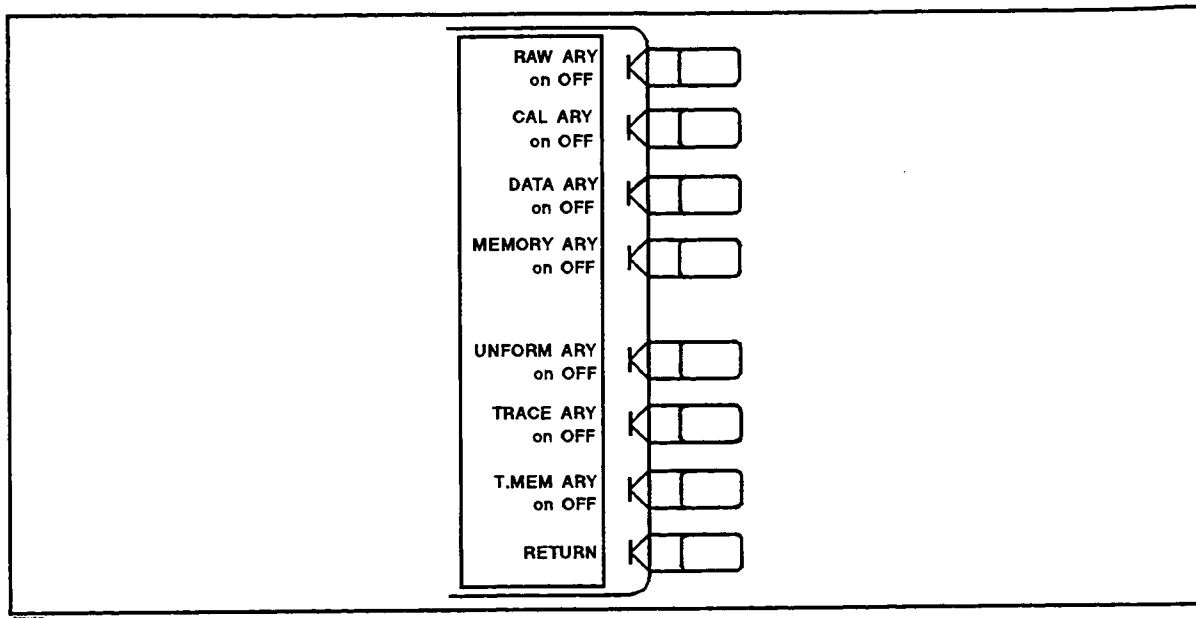

Figure 11-10. Define Save Data Menu

RAW ARY on OFF (SAVRAON, SAVRAOFF) toggles saving or not saving the raw data arrays.

CAL ARY on OFF (SAVCAON, SAVCAOFF) toggles saving or not saving the calibration coefficients arrays.

DATA ARY on OFF (SAVDAON, SAVDAOFF) toggles saving or not saving the data arrays.

MEMORY ARY on OFF (SAVMAON, SAVMAOFF) toggles saving or not saving the memory arrays.

UNFORM ARY on OFF (SAVUAON, SAVUAOFF) toggles saving or not saving the unformat arrays.

TRACE ARY on OFF (SAVTAON, SAVTAOFF) toggles saving or not saving the trace arrays.

T.MEM ARY on OFF (SAVTMAON, SAVTMAOFF) toggles saving or not saving the memory trace arrays.

RETURN returns to the save file menu.

SAVE and RECALL Keys

Re-save File Menu

This menu lists the sorted file names, which were previously saved, on the softkey label area and allows updating the file with the current instrument states or data.

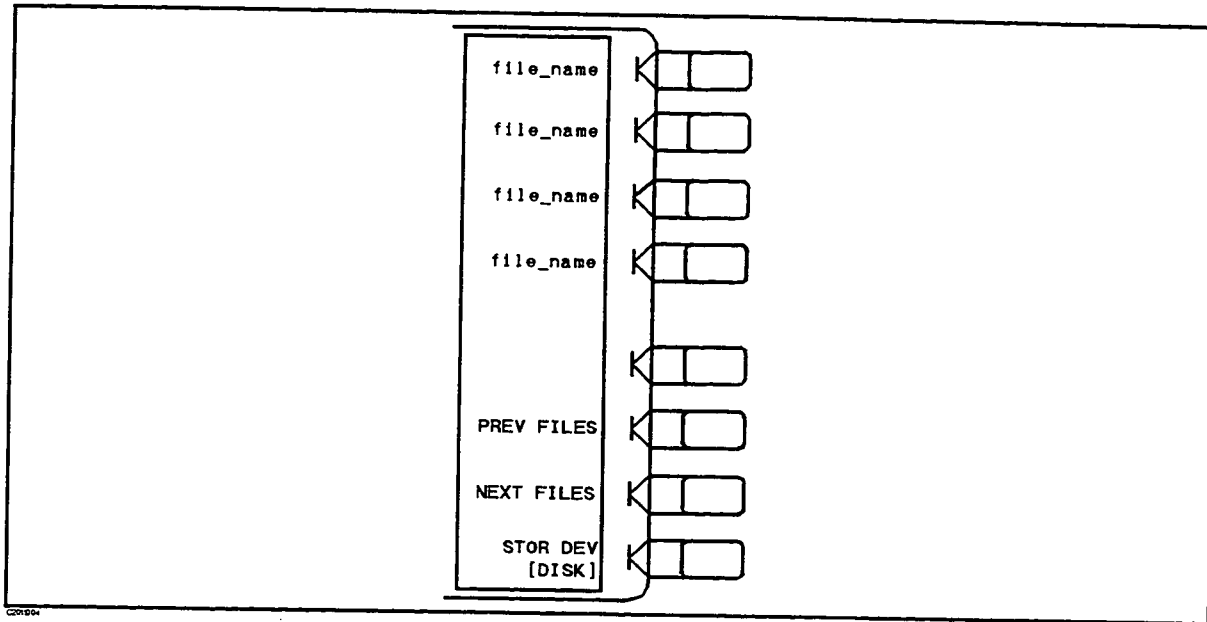

Figure 11-11. Re-save File Menu

file_name updates the file previously saved with the current instrument states or data. The data group to be saved is determined by the file name's extension. Refer to "File Names" for more details about file name extensions.

PREV FILES displays the previous file names in the softkey label to re-save data.

NEXT FILES displays the next file names in the softkey label to re-save data.

STOR DEV (STODISK STODMEMO) selects between the flexible disk drive and the RAM disk memory as the storage device. **[DISK]** shows the built-in flexible disk is selected and **[MEMORY]** shows the RAM disk memory is selected. This setting does not change even when the line power is cycled or the **PRESET** key is pressed.

Note



For DOS formatted disks, all available files and directories under the current directory are listed. A "\ " is attached at the end of the label if the softkey label shows a directory name.

Pressing a softkey directory listing label changes the current directory to the directory selected, and the files and directories under the new directory are listed.

Disk Menu

This menu provides the Purge File and Initialize menus from which to purge a file and initialize a disk, respectively.

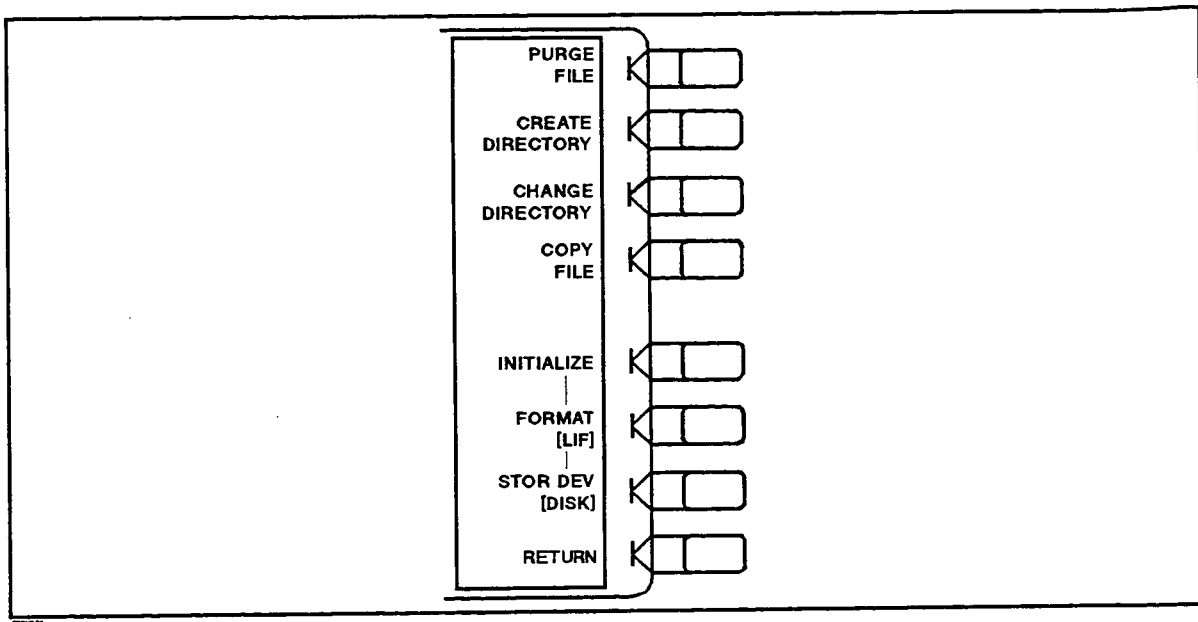

Figure 11-12. Disk Menu

PURGE FILE (PURG) leads to the Purge File menu, from which to remove a file saved on the disk.

CREATE DIRECTORY (CRED) specifies creating a new directory in a DOS format disk. This function is not available for LIF files.

CHANGE DIRECTORY (CHAD) specifies changing the current directory of a DOS format disk. This function is not available for LIF files.

COPY FILE (FILC) copies files.

INITIALIZE (INID) leads to the Initialize menu. A new disk must be initialized before data is stored on it. The disk can be formatted in either LIF or DOS format.

FORMAT (DISFLIF DISFDOS) selects the disk format to be used when initializing a new disk.

STOR DEV (STODDISK STODMEMO) selects between the flexible disk drive and the RAM disk memory as the storage device. **[DISK]** shows the built-in flexible disk is selected and **[MEMORY]** shows the RAM disk memory is selected. This setting does not change even when the line power is cycled or the **PRESET** key is pressed.

RETURN returns to the Save menu.

SAVE and **RECALL** Keys

Purge File Menu

This menu lists the sorted file names, which were previously saved, on the softkey label area and allows selecting a file to be removed from the disk.

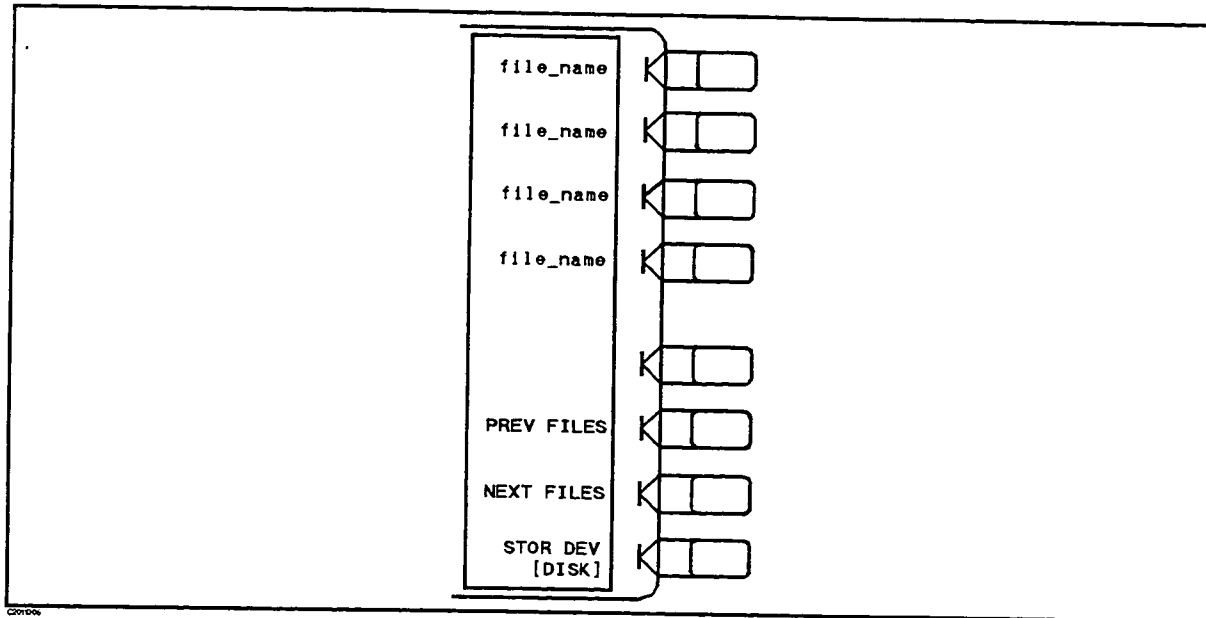

Figure 11-13. Purge File Menu

file_name selects the file name to be removed and provides the purge menu to remove the selected file.

PREV FILES displays set of previous file names in the softkey label area.

NEXT FILES displays next file names in the softkey labels area.

STOR DEV (STODDISK STODMEMO) selects between the flexible disk drive and the RAM disk memory as the storage device. **[DISK]** shows the built-in flexible disk is selected and **[MEMORY]** shows the RAM disk memory is selected. This setting does not change even when the line power is cycled or the **PRESET** key is pressed.

Note



All available files and directories under the current directory are listed for DOS format disk. A “\” is attached at end of the label if the softkey label represents a directory name.

Pressing a softkey listing directory changes the current directory to the directory pressed, the files and directories under the new directory are then listed.

Note



Before recalling a binary data file, set the trigger (under **MENU**) to hold to avoid only momentary recall of data.

Purge Menu

This menu confirms the purge operation and removes the selected file.

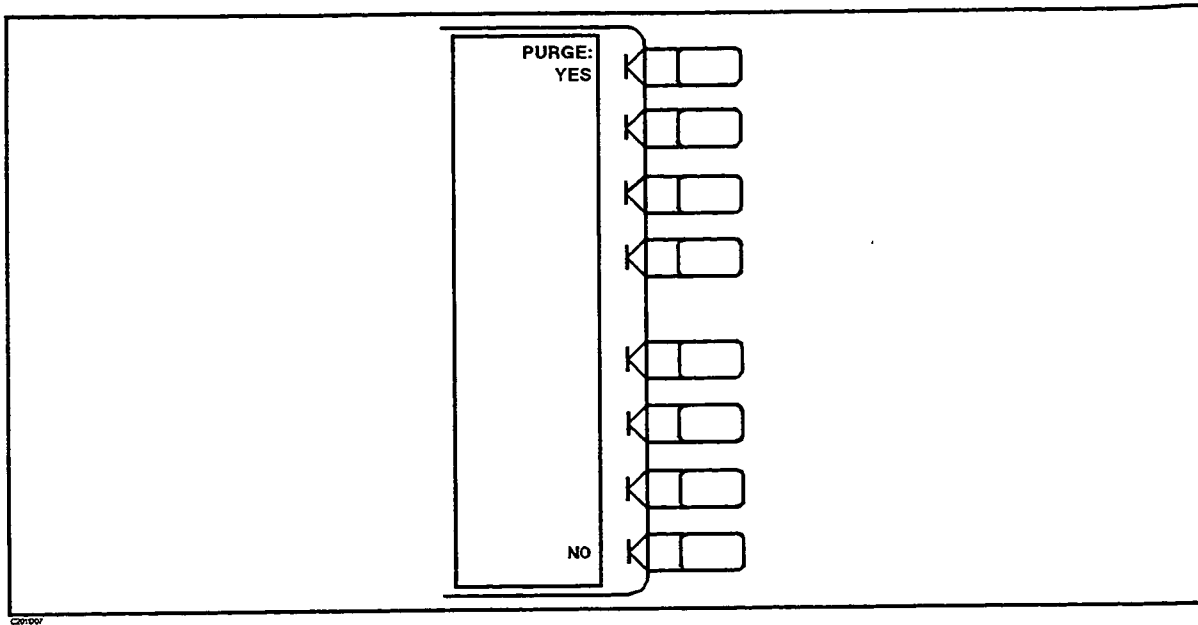

Figure 11-14. Purge Menu

PURGE: YES remove the file and return to the purge file menu.

NO returns to the purge file menu without purging the file.

SAVE and **RECALL** Keys

Initialize Menu

A new disk must be initialized in either the LIF or DOS format before it is used.

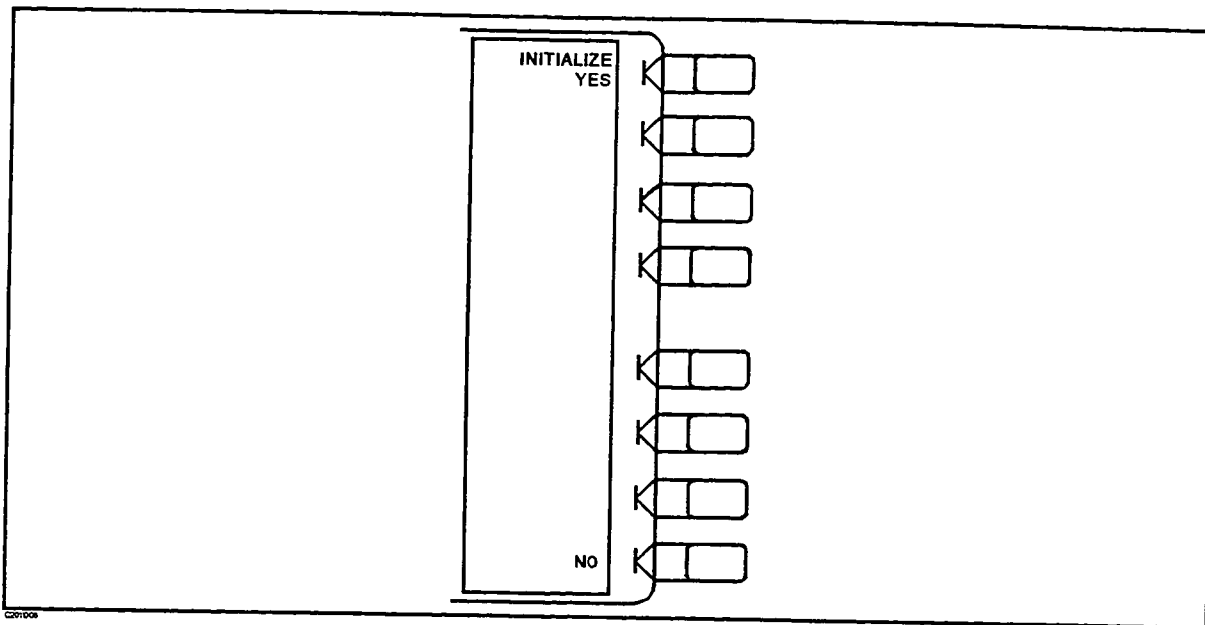

Figure 11-15. Initialize Menu

Caution



If a disk is initialized, all data on the disk is cleared. Be sure no needed data is saved on the disk before initialize a disk.

INITIALIZE YES initializes the disk, then returns to the disk menu.

NO returns to the disk menu without initializing the disk.

Recall File Menu

This menu lists sorted file names, which were previously saved, on the softkey label for selection, and recalls the selected file. The data group to be recalled depends on the file name extension or suffix. Refer to "File Names" for more detail.

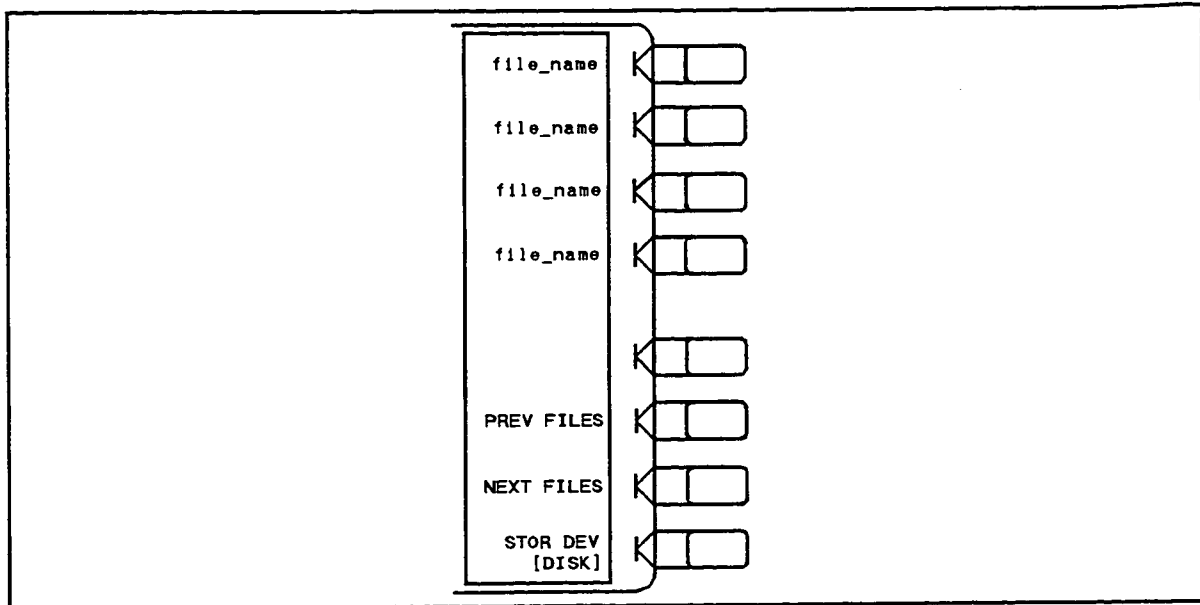

Figure 11-16. Recall File Menu

file_name selects a file to be loaded and loads the instrument state or data.

PREV FILES displays the previous set of file names on the softkey label to load data.

NEXT FILES displays the next set of file names on the softkey label to load data.

STOR DEV (STODDISK STODMEMO) selects between the flexible disk drive and the RAM disk memory as the storage device. **[DISK]** shows the built-in flexible disk is selected and **[MEMORY]** shows the RAM disk memory is selected. This setting does not change even when the line power is cycled or the **PRESET** key is pressed.

Note



All available files and directories under the current directory are listed for a DOS formatted disk. A "\ " is attached at end of the label if the softkey label shows a directory name.

Pressing a softkey listing directory changes the current directory to the directory name selected, the files and directories under new directory are then listed.

HP-IB Remote Programming

INTRODUCTION

The analyzer is factory-equipped with a remote programming digital interface using the Hewlett-Packard Interface Bus (HP-IB). (HP-IB is Hewlett-Packard's hardware, software, documentation, and support for IEEE 488.1, IEC-625, IEEE 488.2, and JIS-C1901 worldwide standards for interfacing instruments.) This allows the analyzer to be controlled by an external computer that sends commands or instructions to and receives data from the analyzer using the HP-IB. In this way, a remote operator has the same control of the instrument available to a local operator from the front panel, except for the line power switch.

In addition, the analyzer itself can use HP-IB to directly control compatible peripherals, without the use of an external controller. It can output measurement results directly to a compatible printer or plotter.

This chapter provides an overview of HP-IB operation. Chapter 9 provides information on different controller modes, and on setting up the analyzer as a controller of peripherals. It also explains how to use the analyzer as a controller to print and plot. HP-IB equivalent mnemonics for front panel functions are provided in parentheses throughout this manual.

More complete information on programming the analyzer remotely over HP-IB is provided in *HP-IB Programming Manual*. The *HP-IB Programming Manual* includes examples of remote measurements using an HP 9000 series 200 or 300 computer with BASIC programming. The *HP-IB Programming Manual* assumes familiarity with front panel operation of the instrument.

A complete general description of the HP-IB is available in *Tutorial Description of the Hewlett-Packard Interface Bus*, HP publication 5952-0156. For more information on the IEEE 488.1 standard, refer to *IEEE Standard Digital Interface for Programmable Instrumentation*, published by the Institute of Electrical and Electronics Engineers, Inc., 345 East 47th Street, New York 10017, USA.

HOW HP-IB WORKS

The HP-IB uses a party-line bus structure in which up to 15 devices can be connected on one contiguous bus. The interface consists of 16 signal lines and 6 grounded lines in a shielded cable. With this cabling system, many different types of devices including instruments, computers, plotters and printers can be connected in parallel.

Every HP-IB device must be capable of performing one or more of the following interface functions:

Talker

A talker is a device capable of sending device-dependent data when addressed to talk. There can be only one active talker at any given time. Examples of this type of device are voltmeters, counters, and tape readers. The analyzer is a talker when it sends trace data or marker information over the bus.

Listener

A listener is a device capable of receiving device-dependant data when addressed to listen. There can be any number of active listeners at any given time. Examples of this type of device are printers, power supplies, and signal generators. The analyzer is a listener when it is controlled over the bus by a computer.

Controller

A controller is a device capable of managing the operation of the bus and addressing talkers and listeners. There can be only one active controller at any time. Examples of controllers include desktop computers and minicomputers. In a multiple-controller system, active control can be passed between controllers, but there can only be one *system controller*, which acts as the master, and can regain active control at any time. The analyzer is an active controller when it plots or prints in the addressable mode. The analyzer is a system controller when it is in the system controller mode. These modes are discussed in more detail in "HP-IB Menu" in Chapter 9.

HP-IB REQUIREMENTS

Number of Interconnected Devices:	15 maximum.
Interconnection Path/ Maximum Cable Length:	20 meters maximum or 2 meters per device, whichever is less.
Message Transfer Scheme:	Byte serial/bit parallel asynchronous data transfer using a 3-line handshake system.
Data Rate:	Maximum of 1 megabyte per second over limited distances with tri-state drivers. Actual data rate depends on the transfer rate of the slowest device involved.
Address Capability:	Primary addresses: 31 talk, 31 listen. A maximum of 1 active talker and 14 active listener at one time.

Multiple Controller Capability: In systems with more than one controller (like the analyzer system), only one can be active at any given time. The active controller can pass control to another controller, but only one system controller is allowed.

ANALYZER HP-IB CAPABILITIES

As defined by the IEEE 488.1 standard, the analyzer has the following capabilities:

SH1	Full source handshake.
AH1	Full acceptor handshake.
T6	Basic talker, answers serial poll, unaddresses if MLA is issued. No talk-only mode.
L4	Basic listener, unaddresses if MTA is issued. No listen-only mode.
SR1	Complete service request (SRQ) capabilities.
RL1	Complete remote/local capability including local lockout.
PP0	Does not respond to parallel poll.
DC1	Complete device clear.
DT1	Responds to a group execute trigger.
C1, C2, C3	System controller capabilities in system controller mode.
C10	Pass control capabilities in addressable mode.
E2	Tri-state drivers.

BUS MODE

The analyzer uses a single-bus architecture. The single bus allows both the analyzer and the host controller to have complete access to the peripherals in the system.

Setting Addresses

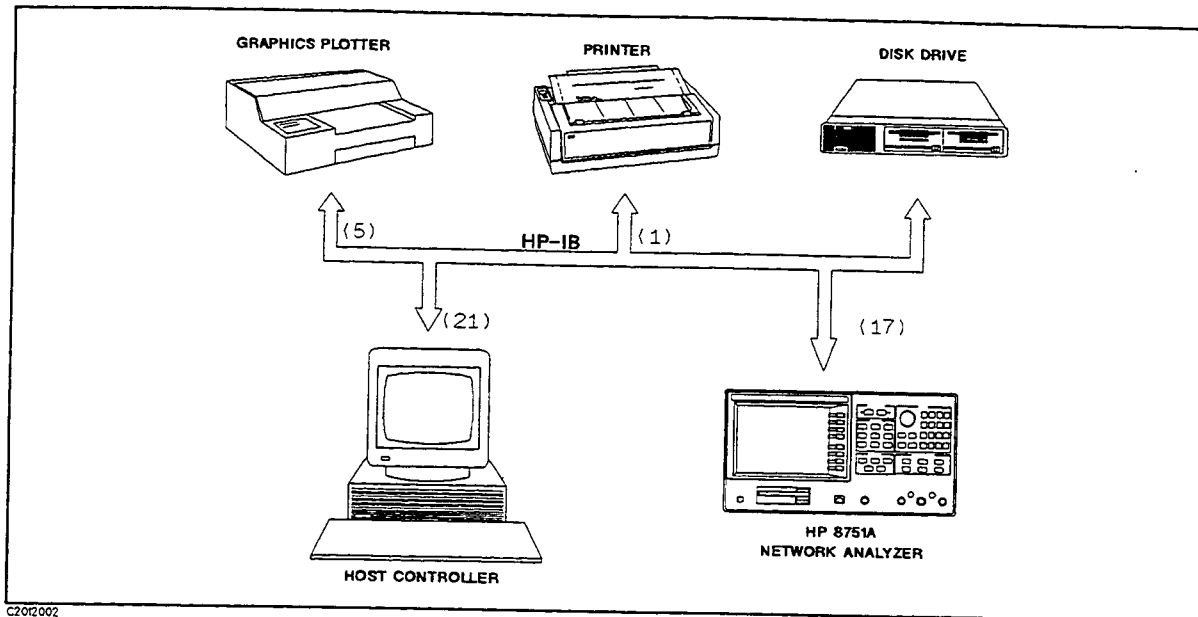

Figure 12-1. Analyzer Single Bus Concept

Two different modes are possible, system controller, and addressable.

- System Controller** This mode allows the analyzer to control peripherals directly in a stand-alone environment (without an external controller). This mode can only be selected manually from the analyzer front panel. Use this mode for operation when no computer is connected to the analyzer. Printing and plotting use this mode.
- Addressable** This is the traditional programming mode, in which the computer is involved in all peripheral access operations. When the external controller is connect the analyzer through HP-IB (as shown in Figure 12-1), this mode allows you to control the analyzer over HP-IB in the talker mode in order to send data, and in the listener mode to receive commands, and also allows the analyzer to take or pass control in order to plot and print.

Chapter 9 explains the two different bus modes in detail, and provides information on setting the correct bus mode. Programming information for the addressable mode is provided in the *HP-IB Programming Manual*.

SETTING ADDRESSES

In communications though HP-IB, each instrument on the bus is identified by an HP-IB address. This address code must be different for each instrument on the bus. Refer to "Address Menu" in Chapter 9 for information on default addresses, and on setting and changing addresses. These addresses are not affected when you press **PRESET** or cycle the power.

A

Default

PRESET STATE

When the **PRESET** key is pressed, or the analyzer is turned ON, the analyzer reverts to a known state. There are subtle differences between the preset state and the power-up state, and these states are defined in Table A-1 to Table A-5.

Some power-up states are recalled from non-volatile memory (battery backup memory). If power to the non-volatile memory is lost, the analyzer will have certain parameters set to factory settings. Table A-7 lists the factory settings. The operating time of the battery backup memory is approximately 72 hours. The battery is automatically recharged while the instrument is ON. The recharge time (time required to fully recharge the battery) is approximately 10 minutes.

When line power is cycled the analyzer performs a self-test routine. Upon successful completion of the self-test routine, the instrument state is set to the following preset conditions. The same conditions are true following a "PRES" or "*RST" command over the HP-IB bus.

Table A-1. Preset Conditions

Operating Parameter	Initialization method	
	Power-On	PRESET key
Stimulus Conditions		
Sweep Type	Linear frequency	Linear Frequency
Display Mode	Start/Stop	Start/Stop
Trigger Type	Continuous	Continuous
External Trigger	OFF	OFF
Sweep Time	80.4 ms	80.4 ms
Start Frequency	5 Hz (or 100 kHz ¹)	5 Hz (or 100 kHz ¹)
Frequency Span	499.999995 MHz (or 499.9 MHz ¹)	499.999995 MHz (or 499.9 MHz ¹)
CW frequency	100 MHz	100 MHz
Source Power	0 dBm	0 dBm
Start Power	-50 dBm	-50 dBm
Stop Power	-15 dBm	-50 dBm
Power trip	Clear	Clear
Coupled Channels	ON	ON
Frequency List		
Frequency List	Empty	Empty
Edit Mode	Start/Stop, Number of Points	Start/Stop, Number of Points

¹ when S-parameter test set is connected

Table A-2. Preset conditions

Operating Parameter	Initialization method	
	Power-On	PRESET key
Response Conditions		
Parameter		
Channel 1	A/R (or S_{11}^1)	A/R (or S_{11}^1)
Channel 2	B/R (or S_{21}^1)	B/R (or S_{21}^1)
Conversion	OFF	OFF
Format	Log magnitude (all inputs)	Log magnitude (all inputs)
Display	Data	Data
Dual Channel	OFF	OFF
Active Channel	Channel 1	Channel 1
Frequency Blank	Disabled	Disabled
Split Display	ON	ON
Intensity	83 %	No effect (same as before preset)
Background Intensity	0 %	No effect (same as before preset)
Color Selections		
Channel 1 Data	Yellow	No effect (same as before preset)
Channel 1 Memory	Green	No effect (same as before preset)
Channel 2 Data	Blue	No effect (same as before preset)
Channel 2 Memory	Pink	No effect (same as before preset)
Graticule	Gray	No effect (same as before preset)
Warning	Red	No effect (same as before preset)
Text	White	No effect (same as before preset)
Beeper:Done	ON	ON
Beeper:Warning	OFF	OFF
Title	Empty	Empty
Number of Points	201	201
IF Bandwidth	4 kHz	4 kHz
IF Averaging Factor	16; OFF	16; OFF
Smoothing Aperture	1% Span; OFF	1% Span; OFF
Group Delay Aperture	1% Span	1% Span
Phase Offset	0°	0°
Electrical Delay	0 s	0 s
Conjugate Matching	OFF	OFF

¹ when S-parameter test set is connected

Table A-3. Preset conditions

Operating Parameter	Initialization method	
	Power-On	PRESET key
Calibration		
Correction	OFF	OFF
Calibration Type	None	None
Calibration Kit	7 millimeter	7 millimeter
System Impedance	50 Ω	50 Ω
Velocity Factor	1	1
Extensions	OFF	OFF
Port 1	0 s	0 s
Port 2	0 s	0 s
Input R	0 s	0 s
Input A	0 s	0 s
Input B	0 s	0 s
Scale		
Log Magnitude	10 dB	10 dB
Phase	90°	90°
Group Delay	10 nsec	10 nsec
Smith Chart	1	1
Polar Chart	1	1
Linear Magnitude	0.1	0.1
SWR	1	1
Real	0.2	0.2
Imaginary	0.2	0.2
Reference Line Position		
Log Magnitude	5 dB	5 dB
Phase	5°	5°
Group Delay	5 nsec	5 nsec
Smith Chart	-	-
Polar Chart	-	-
Linear Magnitude	0	0
SWR	1	1
Real	5	5
Imaginary	5	5
Reference Value		
Log Magnitude	0 dB	0 dB
Phase	0°	0°
Group Delay	0 nsec	0 nsec
Smith Chart	1	1
Polar Chart	1	1
Linear Magnitude	0	0
SWR	1	1
Real	0	0
Imaginary	0	0

Table A-4. Preset conditions

Operating Parameter	Initialization method	
	Power-On	PRESET key
Markers		
Markers 1,2,3,4,5,6,7,8	5 Hz (or 100 kHz ¹)	5 Hz (or 100 kHz ¹)
Markers ON	all markers off	all markers off
Active Marker	Data	Data
Reference Marker	1	1
Marker Mode	None	None
Delta Marker Mode	Continuous	Continuous
Coupling	OFF	OFF
Marker List	ON	ON
	OFF	OFF
Marker Time	OFF	OFF
Marker Search	OFF	OFF
Marker Target Value	-3 dB	-3 dB
Marker Width Value	-3 dB; OFF	-3 dB; OFF
Marker Tracking	OFF	OFF
Marker Stimulus Offset	0 Hz	0 Hz
Marker Value Offset	0 dB	0 dB
Marker Aux Offset (Phase)	0°	0°
Marker Statistics	OFF	OFF
Polar Marker	LIN MKR	LIN MKR
Smith Marker	R+jX	R+jX
Limit Lines		
Limit Lines	OFF	OFF
Limit Testing	OFF	OFF
Limit Line Table	Clear	No effect (Same as before preset)
Edit Mode	Upper/Lower Limits	Upper/Lower Limits
Stimulus Offset	0 Hz	0 Hz
Amplitude Offset	0 dB	0 dB
Beep Fail	OFF	OFF

¹ when S-parameter test set is connected

Table A-5. Preset conditions

Operating Parameter	Initialization method	
	Power-On	PRESET key
System Parameters		
HP-IB Addresses	Battery backup memory	No effect (same as before preset)
HP-IB Mode	No effect	No effect (same as before preset)
Input Attenuation		
Input A	20 dB	20 dB
Input B	20 dB	20 dB
Input R	20 dB	20 dB
Test Set	The analyzer checks for presence of HP 87511A/B or HP 85046A/B	The analyzer checks for presence of HP 87511A/B or HP 85046A/B
Test Set Attenuation		
Port 1	0 dB	0 dB
Port 2	0 dB	0 dB
Plot		
Copy Time	OFF	OFF
Define Plot	All	All
Plot Quadrant	Full page	Full page
Scale Plot	Full	Full
Plot Speed	Fast	Fast
Line Type for Data	7 (solid)	7 (solid)
Line Type for Memory	7 (solid)	7 (solid)
Print	Standard	Standard
Pen Number		
Channel 1		
Data	1	1
Memory	5	5
Graticule	3	3
Text	1/4/5	1/4/5
Marker	1/5	1/5
Channel 2		
Data	2	2
Memory	6	6
Graticule	3	3
Text	4	4
Marker	2/4/6	2/4/6

Table A-6. Preset Conditions

Operating Parameter	Initialization method	
	Power-On	PRESET key
Waveform Analysis		
Analysis range	Full	Full
Analysis data	CH1	CH1
Disk Format		
Format	LIF	LIF
Storage device		
Device	No effect	No effect
GRAPHICS Commands (Option 002 only)		
PEN 1	White	White
PEN 2	Red	Red
PEN 3	Yellow	Yellow
PEN 4	Green	Green
PEN 5	Cyan	Cyan
PEN 6	Blue	Blue

**Table A-7.
Results of Power Loss to Battery Backup Memory (Factory Setting)**

Parameter	Factory Setting
HP-IB Address, HP 8751A	17
HP-IB Address, Plotter	5
HP-IB Address, Printer	1
HP-IB Address, Controller	21
DC Detect or Calibration Coefficients	Reset
Calibration Kit Definitions	Factory set default (Refer to Table A-8 to Table A-13.)
Real Time Clock	1991.1.1
Extension name, ASCII data file	.TXT
Extension name, HP-GL file	.HPG
Storage device	Disk

PREDEFINED CALIBRATION KIT

Predefined Standards

Table A-8. 7 mm Standard Cal Kit

NO.	STANDARD TYPE	C0 $\times 10^{-15} \text{F}$	C1 $\times 10^{-27} \text{F/Hz}$	C2 $\times 10^{-36} \text{F/Hz}^2$	OFFSET DELAY ps	OFFSET LOSS $\text{M}\Omega/\text{s}$	OFFSET Z_0 Ω	STANDARD LABEL
1	SHORT				0	700	50	SHORT
2	OPEN	92.85	0	7.2	0	700	50	OPEN
3	LOAD				0	700	50	BROADBAND
4	DELAY/THRU				0	700	50	THRU
5	LOAD				0	700	50	SLIDING
6	LOAD				0	700	50	LOWBAND
7	SHORT				0	700	50	
8	OPEN	79.4	0	40	0	700	50	OPEN

Table A-9. 50 Ω Type-N Standard Cal Kit

NO.	STANDARD TYPE	C0 $\times 10^{-15} \text{F}$	C1 $\times 10^{-27} \text{F/Hz}$	C2 $\times 10^{-36} \text{F/Hz}^2$	OFFSET DELAY ps	OFFSET LOSS $\text{M}\Omega/\text{s}$	OFFSET Z_0 Ω	STANDARD LABEL
1	SHORT				0	700	50	SHORT[M]
2	OPEN	108	55	130	0	700	50	OPEN[M]
3	LOAD				0	700	50	BROADBAND
4	DELAY/THRU				0	700	50	THRU
5	LOAD				0	700	50	SLIDING
6	LOAD				0	700	50	LOWBAND
7	SHORT				17.544	700	50	SHORT[F]
8	OPEN	62	17	28	17.544	700	50	OPEN[F]

Table A-10. 75 Ω Type-N Standard Cal Kit

NO.	STANDARD TYPE	C0 ×10 ⁻¹⁵ F	C1 ×10 ⁻²⁷ F/Hz	C2 ×10 ⁻³⁶ F/Hz ²	OFFSET DELAY ps	OFFSET LOSS MΩ/s	OFFSET Z ₀ Ω	STANDARD LABEL
1	SHORT				0	1.13×10 ³	75	SHORT[M]
2	OPEN	63.5	84	56	0	1.13×10 ³	75	OPEN[M]
3	LOAD				0	1.13×10 ³	75	BROADBAND
4	DELAY/THRU				0	1.13×10 ³	75	THRU
5	LOAD				0	1.13×10 ³	75	SLIDING
6	LOAD				0	1.13×10 ³	75	LOWBAND
7	SHORT				17.544	1.13×10 ³	75	SHORT[F]
8	OPEN	41	40	5	17.544	1.13×10 ³	75	OPEN[F]

Predefined Standard Class Assignments

Table A-11. Standard Class Assignments Table (7 mm)

CLASS	A	B	C	D	E	F	G	STANDARD CLASS LABEL
S _{11A}	2							OPEN
S _{11B}	1							SHORT
S _{11C}	3							LOAD
S _{22A}	2							OPEN
S _{22B}	1							SHORT
S _{22C}	3							LOAD
Forward Transmission	4							THRU
Reverse Transmission	4							THRU
Forward Match	4							THRU
Reverse Match	4							THRU
Response	1	2	4					RESPONSE
Response & Isolation	1	2	4					RESPONSE

Table A-12. Standard Class Assignments Table (50 Ω Type-N)

CLASS	A	B	C	D	E	F	G	STANDARD CLASS LABEL
S _{11A}	2	8						OPENS
S _{11B}	1	7						SHORTS
S _{11C}	3							LOAD
S _{22A}	2	8						OPENS
S _{22B}	1	7						SHORTS
S _{22C}	3							LOAD
Forward Transmission	4							THRU
Reverse Transmission	4							THRU
Forward Match	4							THRU
Reverse Match	4							THRU
Response	1	7	2	8	4			RESPONSE
Response & Isolation	1	7	2	8	4			RESPONSE

Table A-13. Standard Class Assignments Table (75 Ω Type-N)

CLASS	A	B	C	D	E	F	G	STANDARD CLASS LABEL
S _{11A}	2	8						OPENS
S _{11B}	1	7						SHORTS
S _{11C}	3							LOAD
S _{22A}	2	8						OPENS
S _{22B}	1	7						SHORTS
S _{22C}	3							LOAD
Forward Transmission	4							THRU
Reverse Transmission	4							THRU
Forward Match	4							THRU
Reverse Match	4							THRU
Response	1	7	2	8	4			RESPONSE
Response & Isolation	1	7	2	8	4			RESPONSE

Menu Map

INTRODUCTION

The following figures show the structure of the analyzer's softkey menus. See Appendix E for details of the menus.

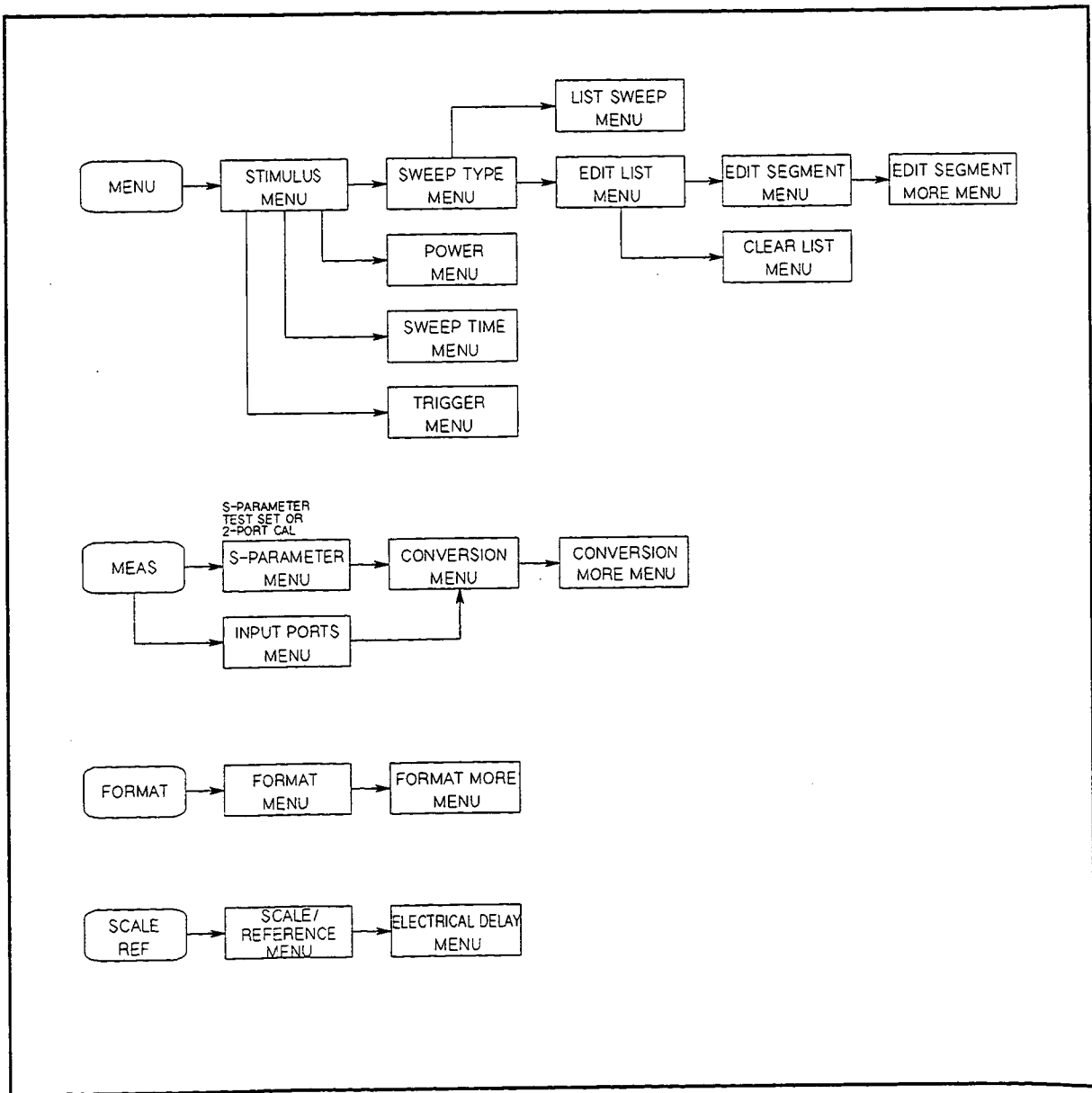

C2008001

Figure B-1. Operating Softkey Menu Map (1 of 5)

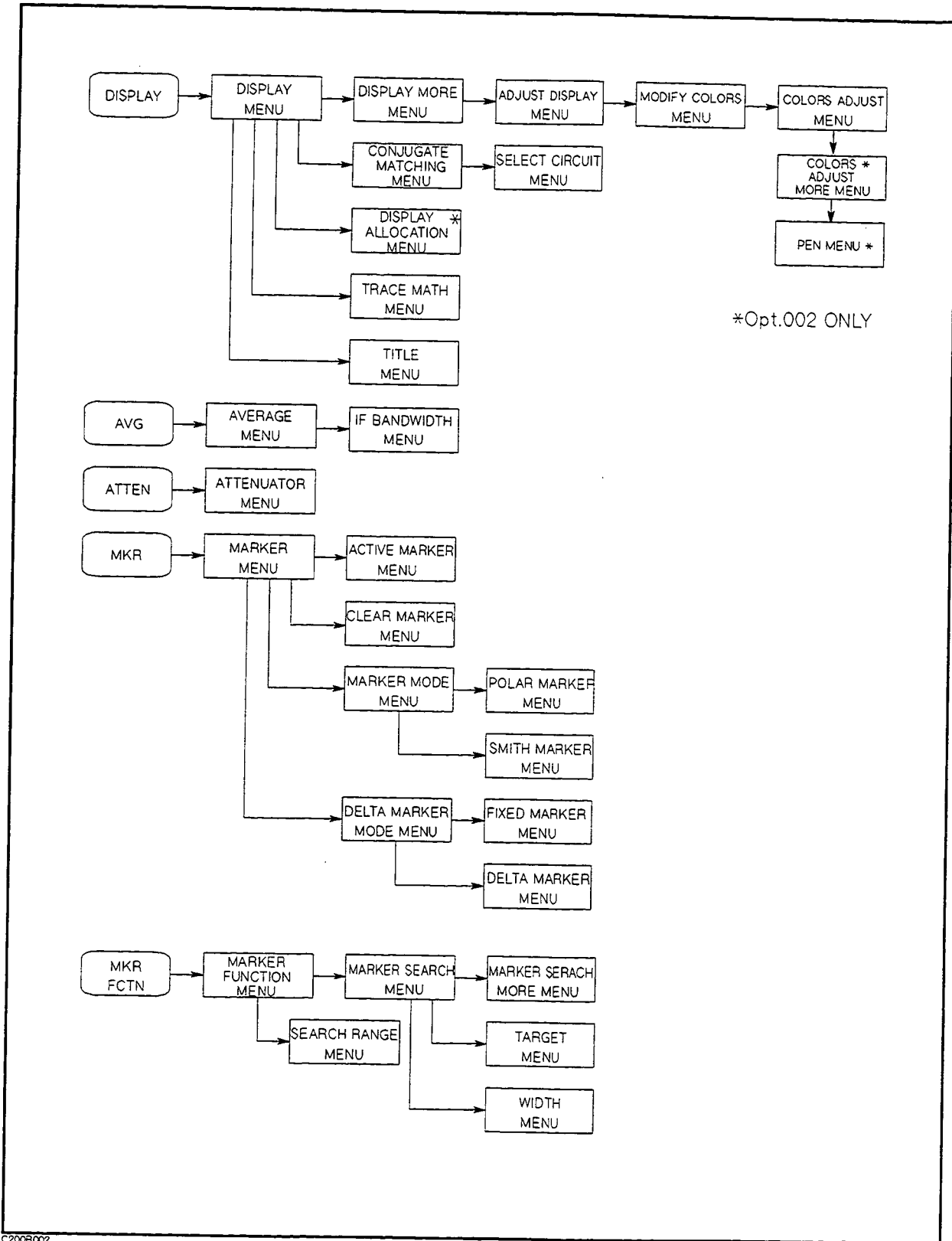
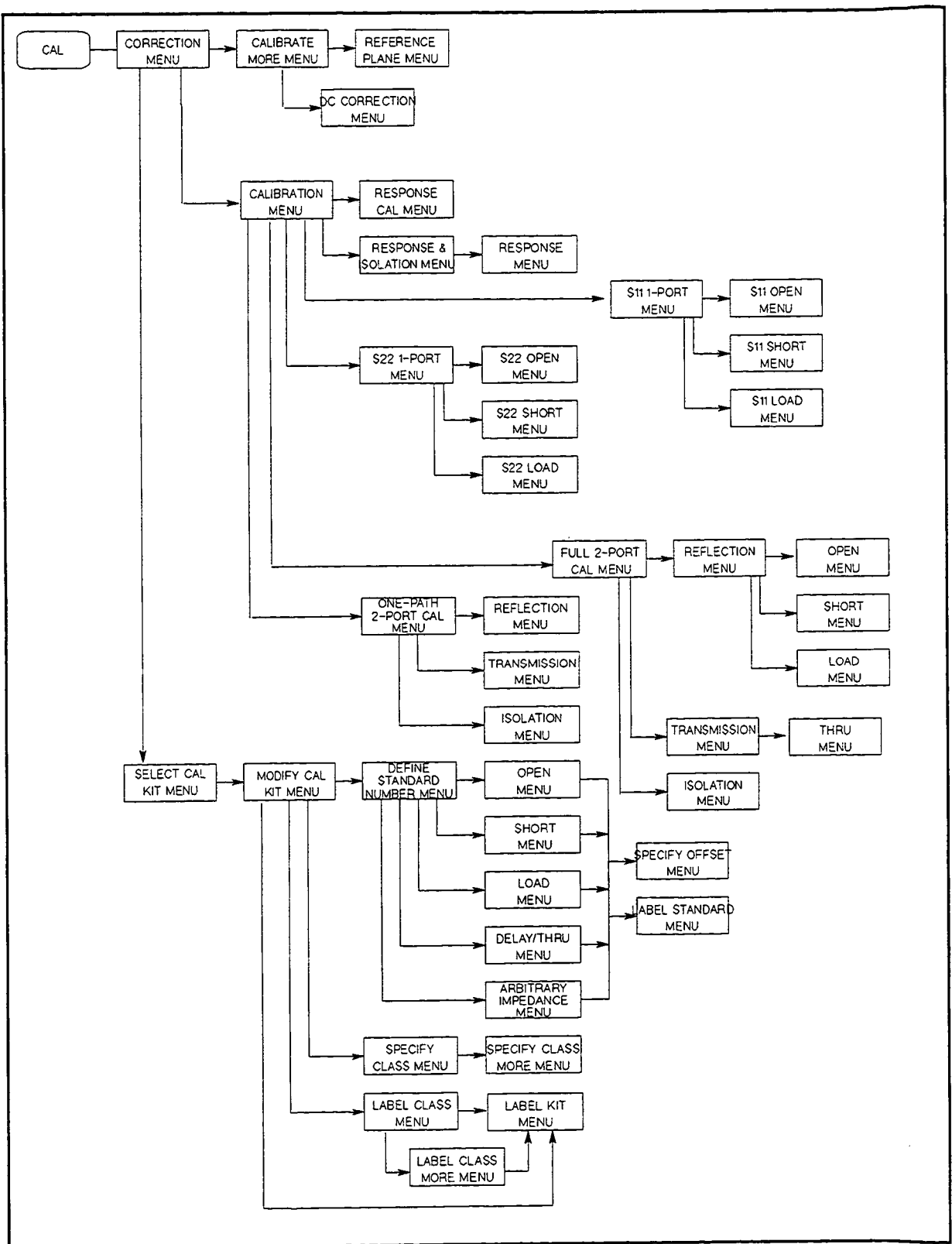
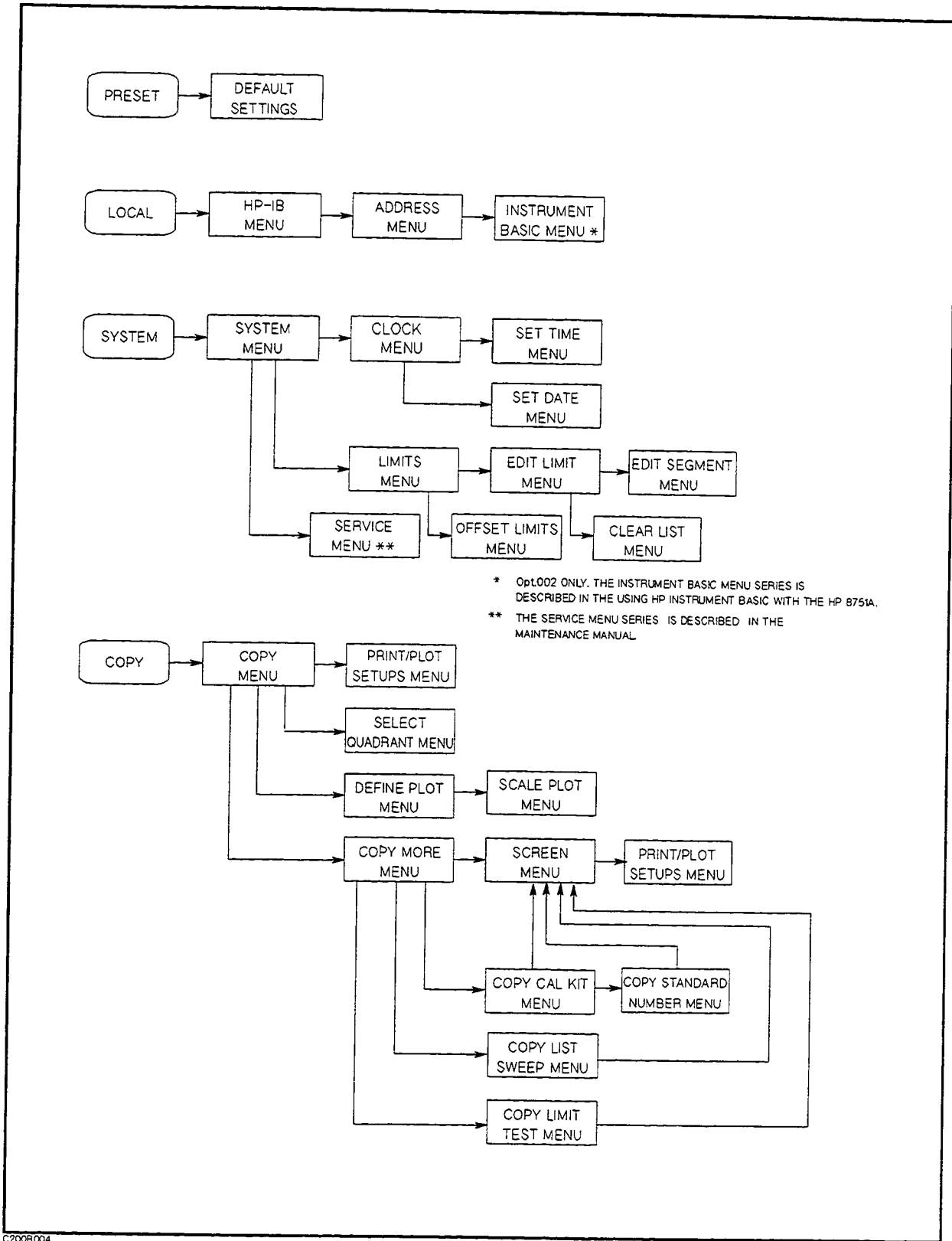

Figure B-2. Operating Softkey Menu Map (2 of 5)



C200B003

Figure B-3. Operating Softkey Menu Map (3 of 5)



C2008004

Figure B-4. Operating Softkey Menu Map (4 of 5)

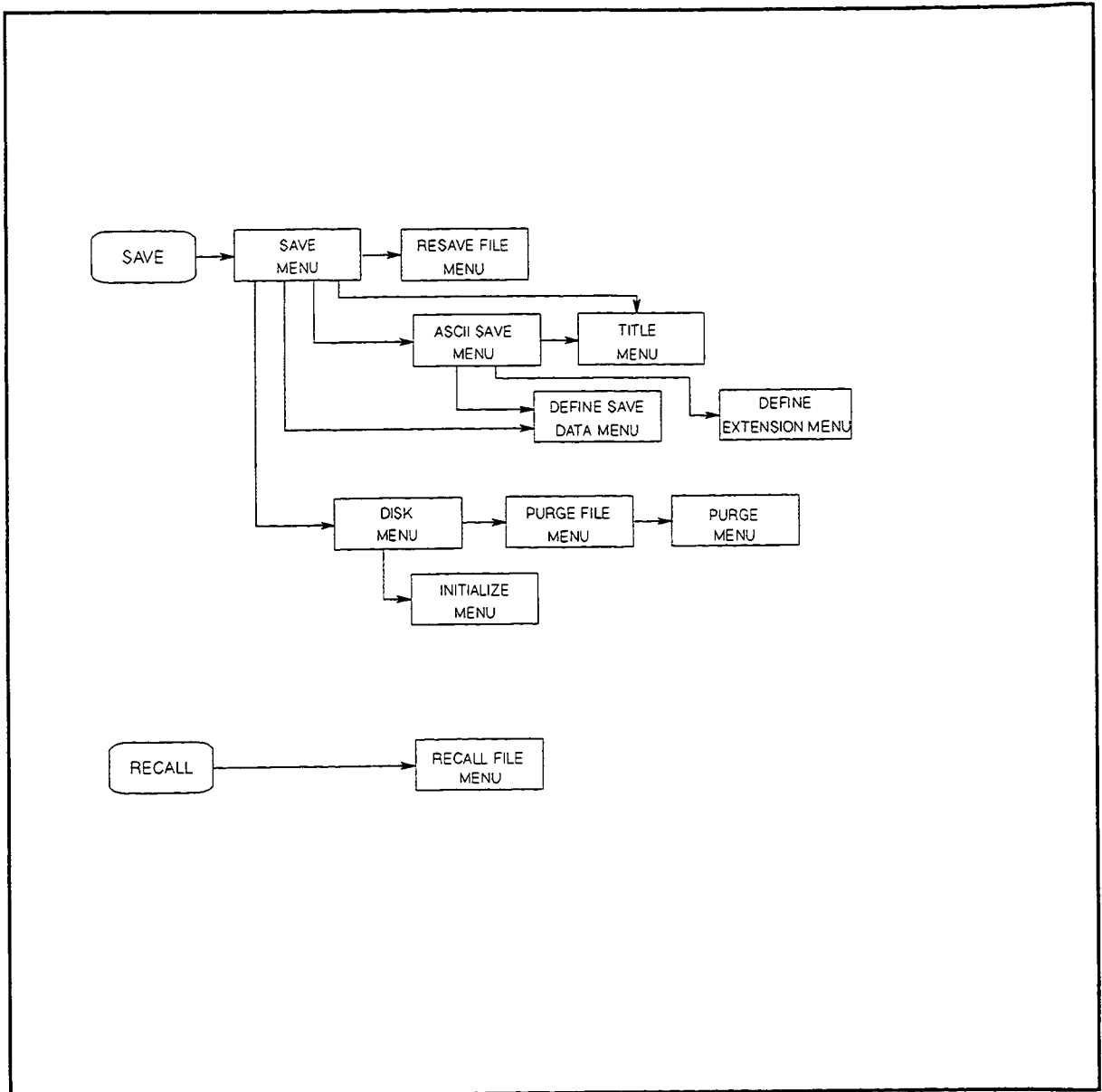

C200B005

Figure B-5. Operating Softkey Menu Map (5 of 5)

I/O Port

I/O PORT

The I/O port on the analyzer rear panel communicates with the external devices such as a handler on a production line.

Pin Assignment

The I/O port consists of 15 TTL compatible signals, which are 8-bit output, 4-bit input, sweep end, pass/fail, and ground. The pin assignments are shown in Figure C-1.

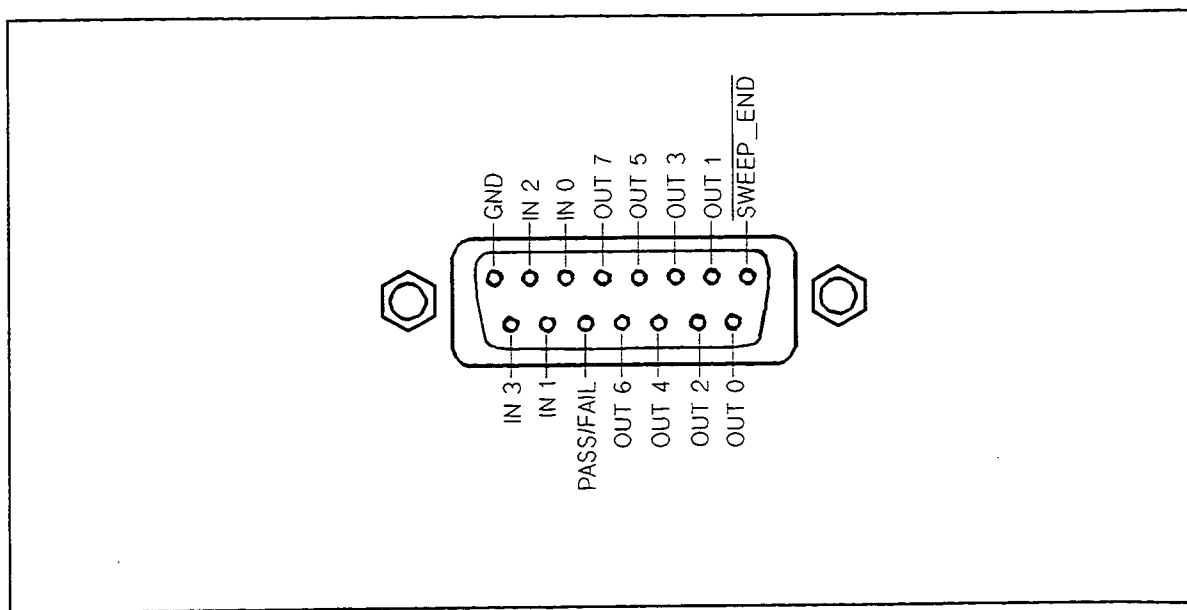

Figure C-1. I/O Port Pin Assignments

The signals carried through each pin are described below.

- SWEEP_END outputs a negative pulse when the analyzer completes a sweep. The pulse width is $> 1.6 \mu\text{s}$.
- OUT 0 thru 7 output signals to external devices and are controlled by two HP-IB commands, OUT8IO, as described below. Once OUT8IO is executed, the signal is latched until OUT8IO is executed again.
- IN 0 thru 4 input signals from external devices and are read by the HP-IB command INP8IO, as described below.

PASS/FAIL is affected only when the Limit Testing, described in "LIMIT LINE AND LIMIT TESTING" in Chapter 9, is active. This signal presents HIGH and LOW if the test result is PASS and FAIL, respectively.

Related HP-IB Commands

There are three HP-IB commands which directly control an I/O port.

- OUT8IO outputs 8-bit data to the OUT 0 thru 7 lines. The OUT 0 signal is the LSB (least significant bit), while the OUT 7 signal is the MSB (most significant bit).
- INP8IO inputs 4-bit data from the IN 0 thru 3 signals to the analyzer's memory. The IN 0 signal is the LSB (least significant bit), while the IN 3 signal is the MSB (most significant bit).
- INP8IO? inputs data from the 4-bit parallel input port to the HP 8751A, and outputs the data to the controller.
- OUTPINP8IO? is a query command which outputs 8 bit data to the controller. The data is obtained as 4-bit data by the INP8IO command and four upper significant bits (value = 0) are attached to extend the 4-bit data to 8-bit data.

Using The I/O Port Without an External Controller nor Instrument BASIC

The I/O port can be used without an external controller nor Instrument BASIC (Opt. 002). Figure C-2 shows an example of a test system using no external controller nor the Instrument BASIC capability.

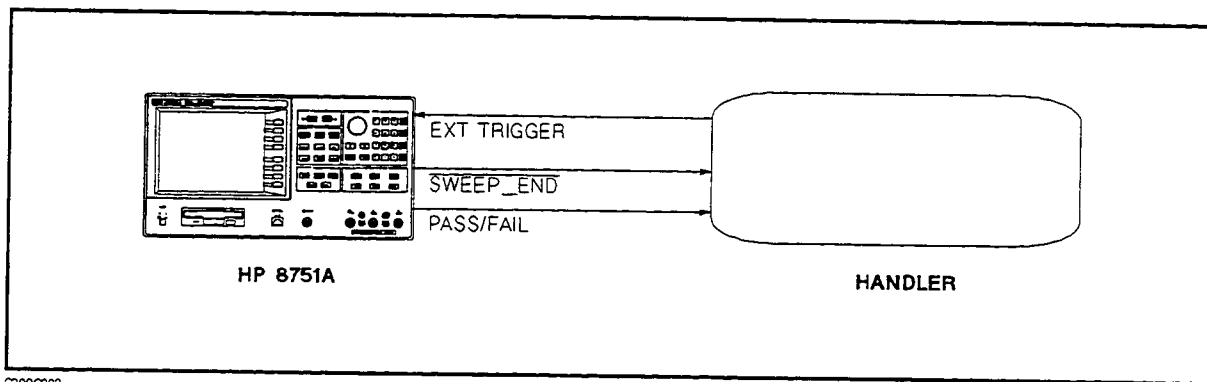

Figure C-2. An Example of a Test System Without Controller

The testing procedure using this system will be as follows.

1. The handler contacts the DUT.
2. The handler outputs a positive going pulse to trigger the analyzer. (See *General Information* section for more details on the external trigger signal.)
3. The analyzer measures the DUT, and outputs a $\overline{\text{SWEEP_END}}$ signal. If the limit test is set to be on, the analyzer also outputs the PASS/FAIL signal to the I/O port.
4. The handler distinguishes if the DUT passes or fails the test, and puts the DUT into the proper bin.
5. Return to the step 1.

Manual Changes

INTRODUCTION

This appendix contains the information required to adapt this manual to earlier versions or configurations of the HP 8751A than the current printing date of this manual. The information in this manual applies directly to the HP 8751A Network Analyzer serial number prefix listed on the title page of this manual.

MANUAL CHANGES

To adapt this manual to your HP 8751A, refer to Table D-1 and Table D-2, and make all of the manual changes listed opposite your instrument's serial number and firmware version.

Instruments manufactured after the printing of this manual may be different than those documented in this manual. Later instrument versions will be documented in a manual changes supplement that will accompany the manual shipped with that instrument. If your instrument's serial number is not listed on the title page of this manual or in Table D-1, it may be documented in a *yellow MANUAL CHANGES* supplement.

Turn on the line switch or execute the “*IDN?” command by HP-IB to confirm the firmware version. Refer to HP-IB Programming Manual for information on the “*IDN?” command. For additional information on serial number coverage, refer to Chapter 1 in General Information.

Table D-1. Manual Changes by Serial Number

Serial Prefix or Number	Make Manual Changes
3026	Change 1 and 3
3123	Change 2 and 3
3146	Change 3

Table D-2. Manual Changes by Firmware Version

Version	Make Manual Changes
2.00 and below	Change 1 and 3
3.00 through 3.02	Change 2 and 3
4.00 through 4.02	Change 3

CHANGE 1 FOR GENERAL INFORMATION

Page 1-2, "Waveform Analysis Commands"

Delete this section.

CHANGE 1 FOR REFERENCE MANUAL

Page 1-7, "Conversion Transforms"

Change the description in the "Conversion Transforms" section to the following:

Conversion Transforms

This transforms the measured S-parameter data to the equivalent complex impedance (z) or admittance (Y) values, or to inverse S-parameters ($1/S$). Refer to "Conversion Menu" in Chapter 6.

Page 2-5, "FRONT PANEL FEATURES"

Change the description of "14. *Built-in Flexible Disk Drive*" to the following:

14. *Built-in Flexible Disk Drive*. This stores the data measured, instrument status, list sweep tables, and Instrument BASIC programs. Disk format is LIF (Logical Interchange Format).

Page 2-6, "CRT DISPLAY"

Replace the fourth paragraph with the following:

The screen can also be used as the Instrument BASIC display. Instrument BASIC uses a full-screen display or a half-screen display below the graticule display as a text screen.

Page 6-2, "MEAS KEY"

Delete the Conversion More menu and MORE softkey label in the Conversion menu in Figure 6-2.

Delete the following descriptions:

The math capabilities allow multiplying phase data by a factor of 4, 8, or 16.

Page 6-8, "Conversion Menu"

Delete the **MORE** softkey label in the Conversion menu in Figure 6-8.

Delete the following description:

MORE provides the Conversion More menu described in the next section.

Page 6-9, "Conversion More Menu"

Delete this page.

Page 6-24, "Figure 6-30."

Delete Pen menu and MORE in the Modify Colors more menu, in Figure 6-30.

Page 6-36, "Modify Colors More Menu"

Delete MORE in the Figure 6-42.

Delete the following description:

MORE leads to the Pen menu.

Page 6-37, "Pen Menu"

Delete this page.

Page 8-2

Delete the following note.

Note

The marker functions are not affected by waveform analysis command execution. For more information on the wave form analysis commands, refer to the *HP 8751A HP-IB Programming Manual*.

Page 10-1, "INTRODUCTION"

Delete the following note.

Note

The ASCII Save menu is provided under the **SAVE** key to save the graphics image on the screen in an HP-GL file on the disk. For more information, refer to Chapter 11.

Page 10-7, "Define Plot Menu"

Delete the following description.

The definition selected in this menu affects the save graphics function under the **SAVE** key, which saves a graphics screen image in an HP-GL file on the disk.

Page 11-1, "STORAGE DEVICES"

Delete this section.

Page 11-2, "Binary Files and ASCII Files"

Delete this section.

Page 11-2, "Data Groups"

Change the description in the "Data Groups" section to the following:

You can select and save one of the following three data groups to a disk.

- Instrument state
- Internal data arrays
- Instrument states and internal data arrays

Page 11-4, "Internal Data Arrays (ASCII file)"

Delete this section.

Page 11-4, "Graphics"

Delete this section.

Page 11-4, "Disk Formats"

Delete this section.

Page 11-4, "File Names"

Change the description to the following:

All data saved using the built in disk drive has an identifying file name. A file name consists of the lower and upper case alphabet, numbers, and valid symbol characters. Up to 8 characters can be used for a file name. The following table shows the valid characters for LIF file names.

Page 11-4, "Table 11-1. Valid Characters for File Names"

Delete the "DOS Format" column.

Page 11-5, "Table 11-2. Suffixes and Extensions Added Automatically"

Delete the "Extensions for DOS" column.

Page 11-5, "Table 11-4. File Size Versus Number of Points (ASCII files) 1/2"

Delete this table.

Page 11-6, "Table 11-5. File Size Versus Number of Points (ASCII files) 2/2"

Delete this table.

Page 11-6, "File Structure of Internal Data Arrays File for Binary Files"

Delete the following note:

Note

Binary and ASCII file structures are not compatible.



Page 11-8, "File Structure of Internal Data Arrays File for ASCII File"

Delete this section.

Page 11-14, "Figure 11-5."

Replace Figure 11-5 with the following figure:

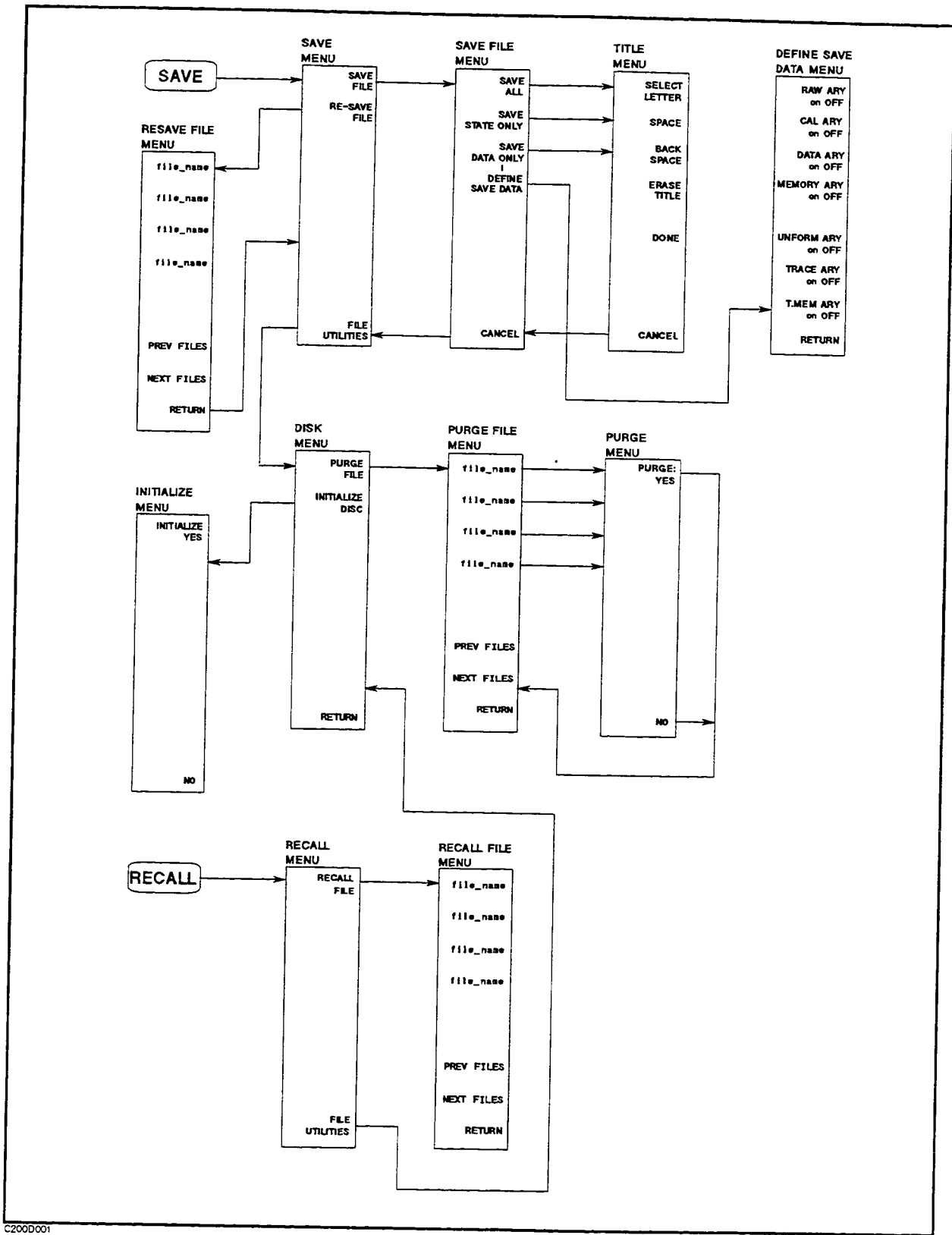

C200D001

Figure 11-5. Softkey Menus Accessed from the **SAVE** and **RECALL** Keys

Page 11-15, "Save Menu"

Replace the Save Menu description with the following description:

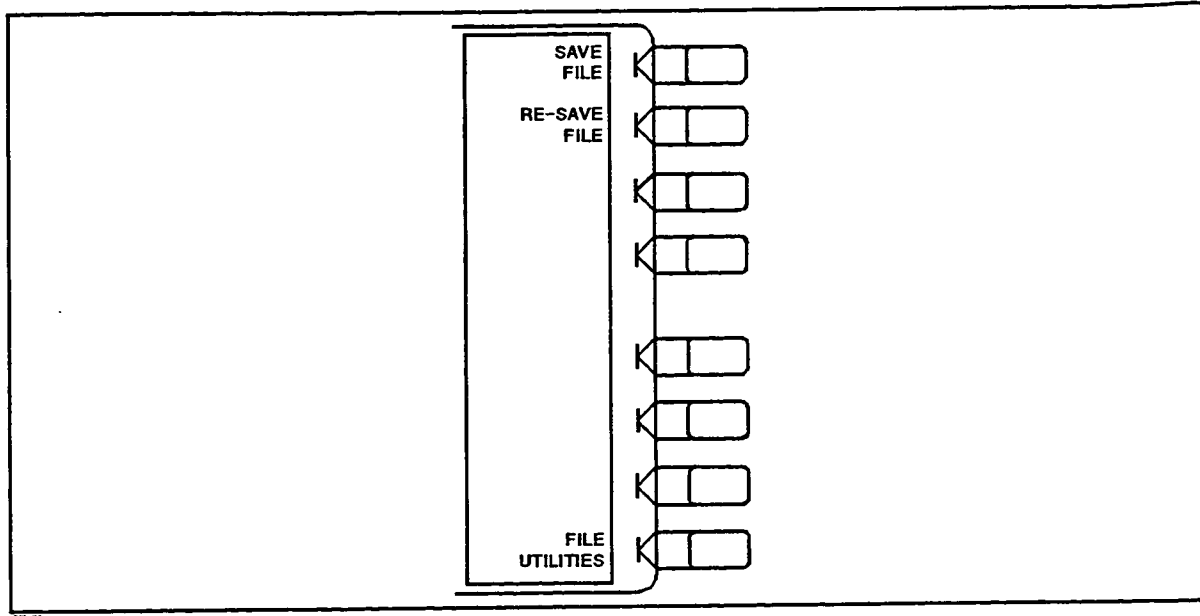

Figure 11-6. Save Menu

SAVE FILE provides the save file menu, which defines the data group to be saved.

RE-SAVE FILE (RESAVED) leads to the re-save file menu, which updates a file already saved.

FILE UTILITIES provides the disk menu from which you initialize a new disk, and purge files.

Add the following page after "Save Menu".

Save File Menu

Either or both the internal data arrays and the instrument state can be saved on a disk.

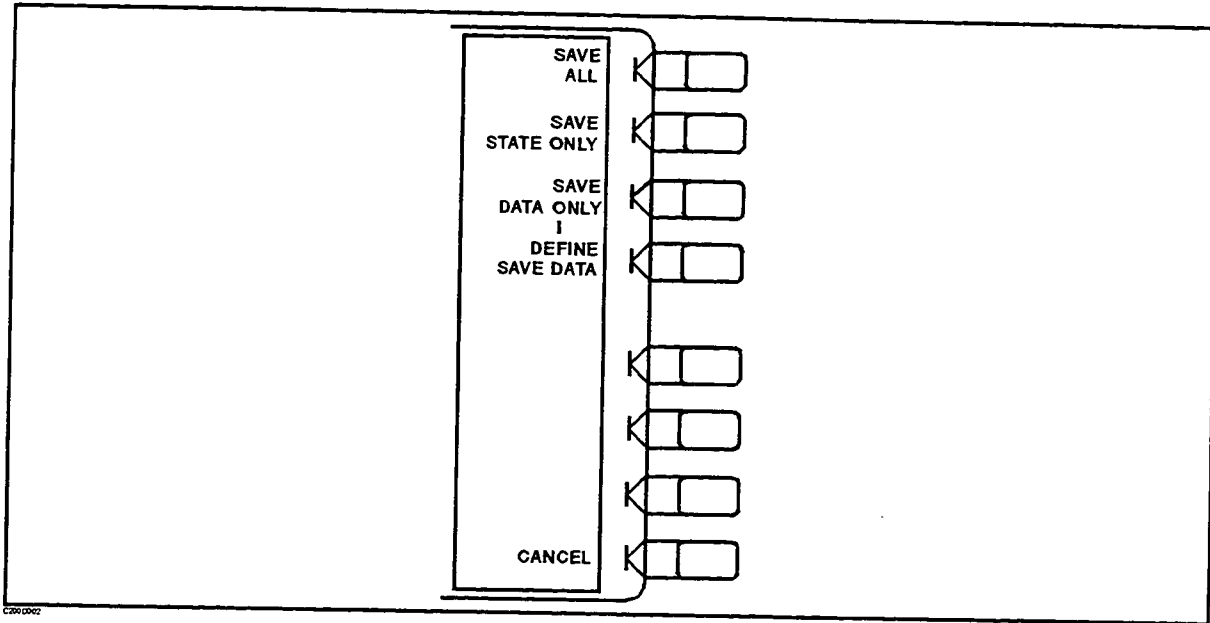

Save File Menu

SAVE ALL (SAVDAL) specifies to save the instrument states, the "data arrays", and the "memory arrays".

SAVE STATE ONLY (SAVDSTA) specifies to save only the instrument states and the calibration coefficients.

SAVE DATA ONLY (SAVDDAT) specifies to save the internal data arrays which is defined by the **DEFINE SAVE DATA** key.

DEFINE SAVE DATA provides the define save data menu which selects the applicable data arrays to be saved.

Page 11-16, "Title Menu"

Replace the Title Menu description to the following description:

This menu defines a file name to be saved.

The file title is up to eight characters of alphabet (upper and lower case), figures, etc. If more than eight characters are selected, the last character is written over repeatedly .

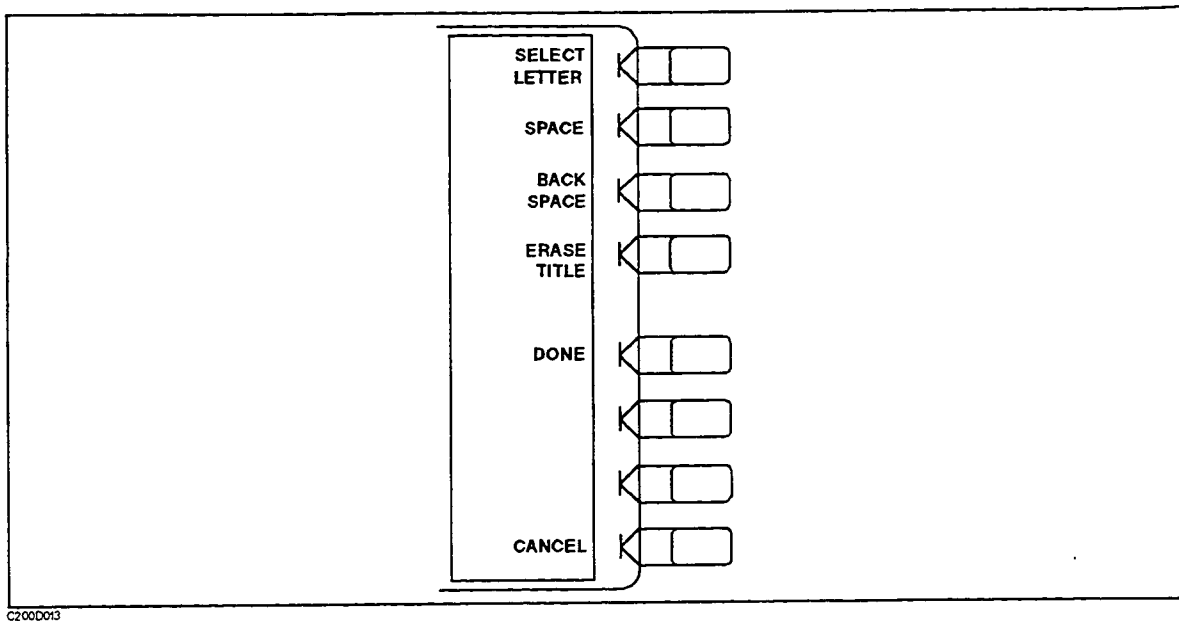

Figure 11-7. Title Menu

SELECT LETTER The active entry area displays the letters of the alphabet, figures, etc. To define a title, rotate the knob until the arrow ↑ points at the desired letter, then press **SELECT LETTER**. Repeat this until the complete file name is defined, for a maximum of eight characters.

SPACE Because the LIF format doesn't allow any spaces in the file name. Don't use this key.

BACK SPACE deletes the last character entered.

ERASE TITLE deletes the entire file name.

DONE saves the data specified in the define save menu and return to the save menu.

CANCEL quits this menu without saving the file, and return to the save menu.

Page 11-17, "ASCII Save Menu"

Delete this page.

Page 11-18, "Define Extension Menu"

Delete this page.

Page 11-20, "Re-save File Menu"

Replace the Re-save File Menu description with the following description:

This menu lists the sorted file names, which were previously saved, on the softkey label area and allows updating the file with the current instrument state or data.

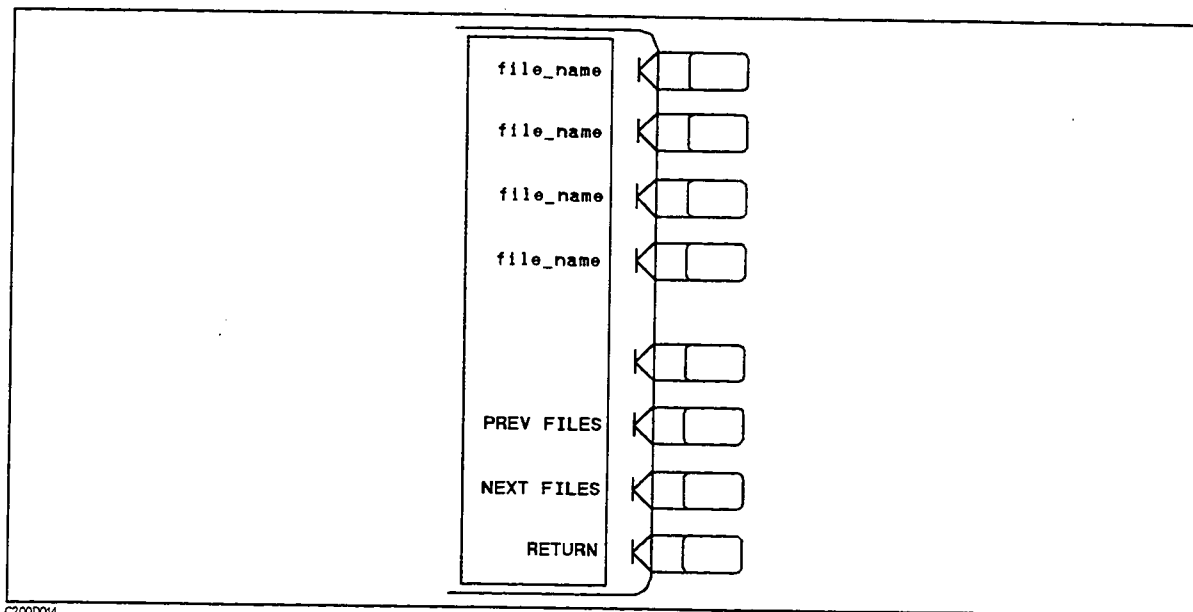

Figure 11-11. Re-save File Menu

file_name updates the file previously saved with the current instrument states or data. The data group to be saved is determined by the file name's extension. Refer to "File Names" in Chapter 11 for more detail about extension.

PREV FILES displays previous file names in the softkey label to re-save data.

NEXT FILES displays next file names in the softkey label to re-save data.

RETURN returns the save menu.

Page 11-21, "Disk Menu"

Replace the Disk Menu description to the following description:

This menu provides the Purge File and Initialize menus from which to purge a file and initialize a disk, respectively.

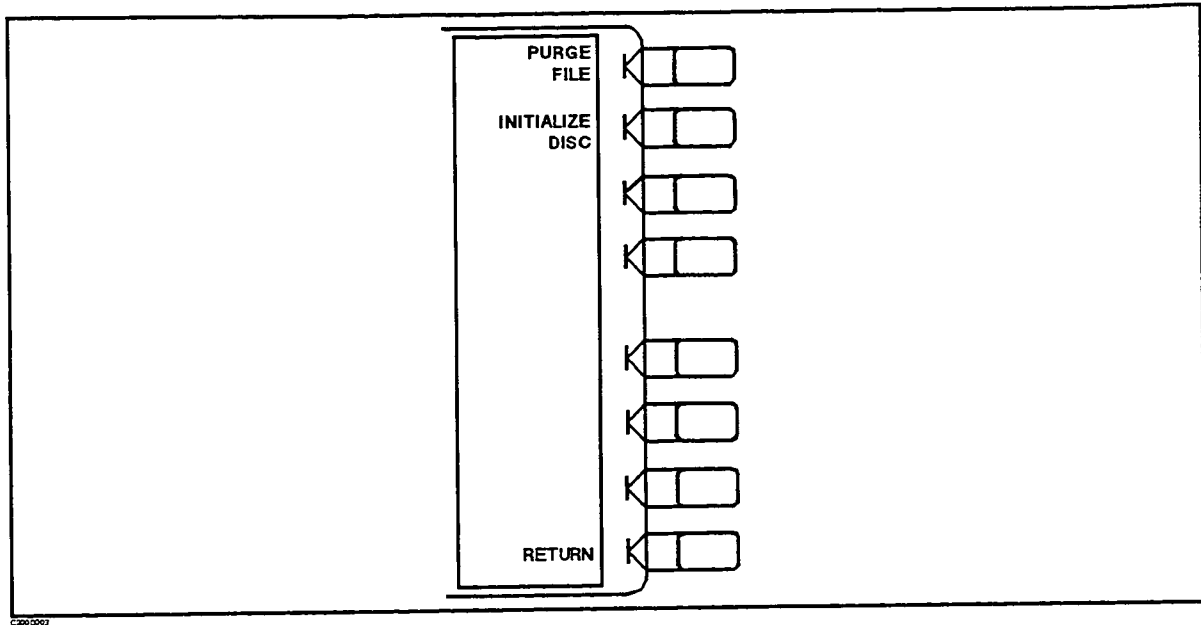

Figure 11-12. Disk Menu

PURGE FILE (PURG) leads to the Purge File menu, from which to remove a file saved on the disk.

INITIALIZE DISK (INID) leads to the Initialize menu. A new disk must be initialized before data can be stored on it. The disk is formatted in LIF format.

RETURN returns to the Save menu.

Page 11-22, "Purge File Menu"

Replace the Purge File Menu description with the following description:

This menu lists the sorted file names, which were previously saved, on the softkey label area and allows selecting a file to be removed from the disk.

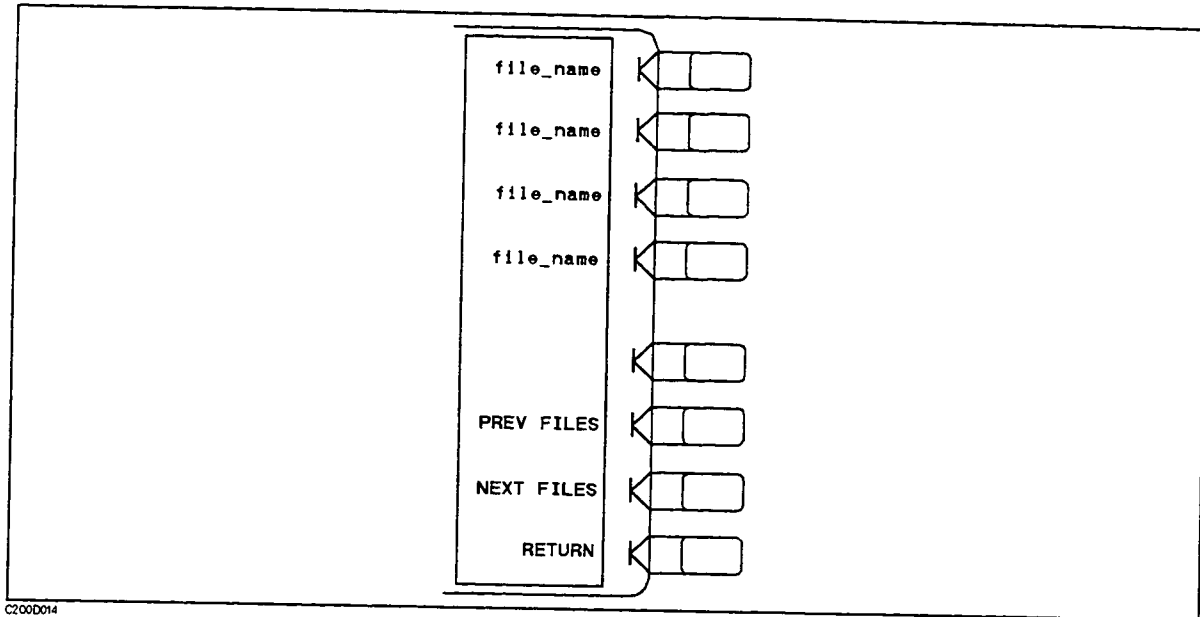

Figure 11-13. Purge File Menu

file_name selects the file name to be removed and provides the purge menu to remove the selected file.

PREV FILES displays set of previous file names in the softkey label area.

NEXT FILES displays next file names in the softkey labels area.

RETURN returns to the disk menu.

Page 11-24, "Initialize Menu"

Replace the Initialize Menu description with the following description.

A new disk must be initialized in LIF format before it is used. The initialization format is selected from the Define Format menu.

Add the following section before the "Recall File Menu" section.

Recall Menu

This provides the menus for data recalling or file utilities.

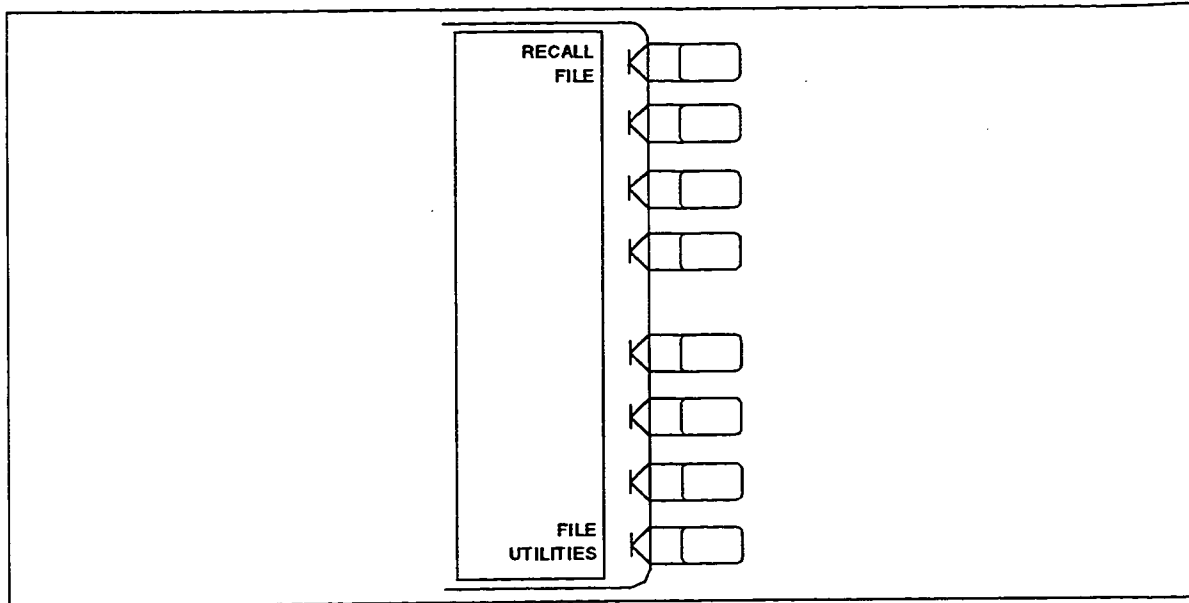

C200D016

Figure 11-16. Recall Menu

RECALL FILE (RECD) leads to the recall file menu, which loads the instrument states or data from the disk.

FILE UTILITIES leads to the disk menu, from which to initialize a disk, and purge files.

Page 11-25, "Recall File Menu"

Replace the Recall File Menu description with the following description:

This menu lists sorted file names, which were previously saved, on the softkey label for selection, and recalls the selected file. The data group to be recalled depends on the file name extension. Refer to "File Names" in Chapter 11 for more detail.

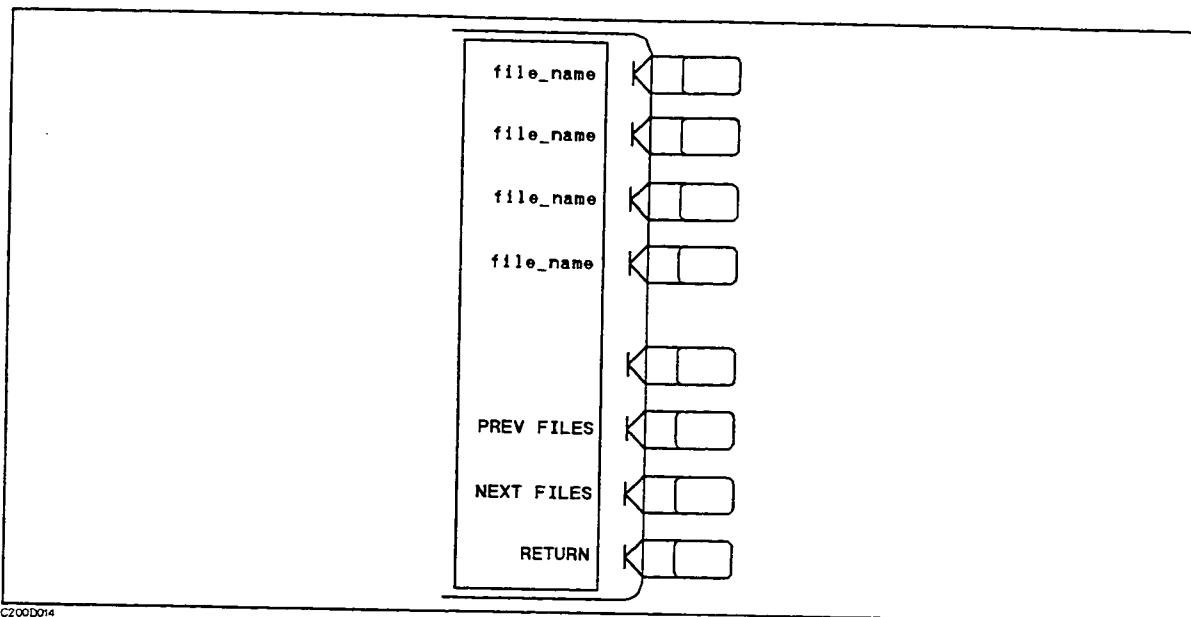

Figure 11-16. Recall File Menu

file_name selects a file to be loaded and loads the instrument state or data.

PREV FILES displays previous set of file names on the softkey label to load data.

NEXT FILES displays next set of file names on the softkey label to load data.

RETURN returns to the recall menu.

Page A-6, "Table A-6. Preset Conditions"

Delete this table.

Page A-6, "Table A-7, Results of Power Loss to Battery Backup Memory (Factory Setting)"

Delete the following item from Table A-6.

- Extension name, ASCII data file
- Extension name, HP-GL file

Page B-1, "Figure B-1"

Delete "CONVERSION MORE MENU".

Page B-2, "Figure B-2"

Delete "PEN MENU".

Page B-5, "Figure B-5"

Replace Figure B-5 to the following one:

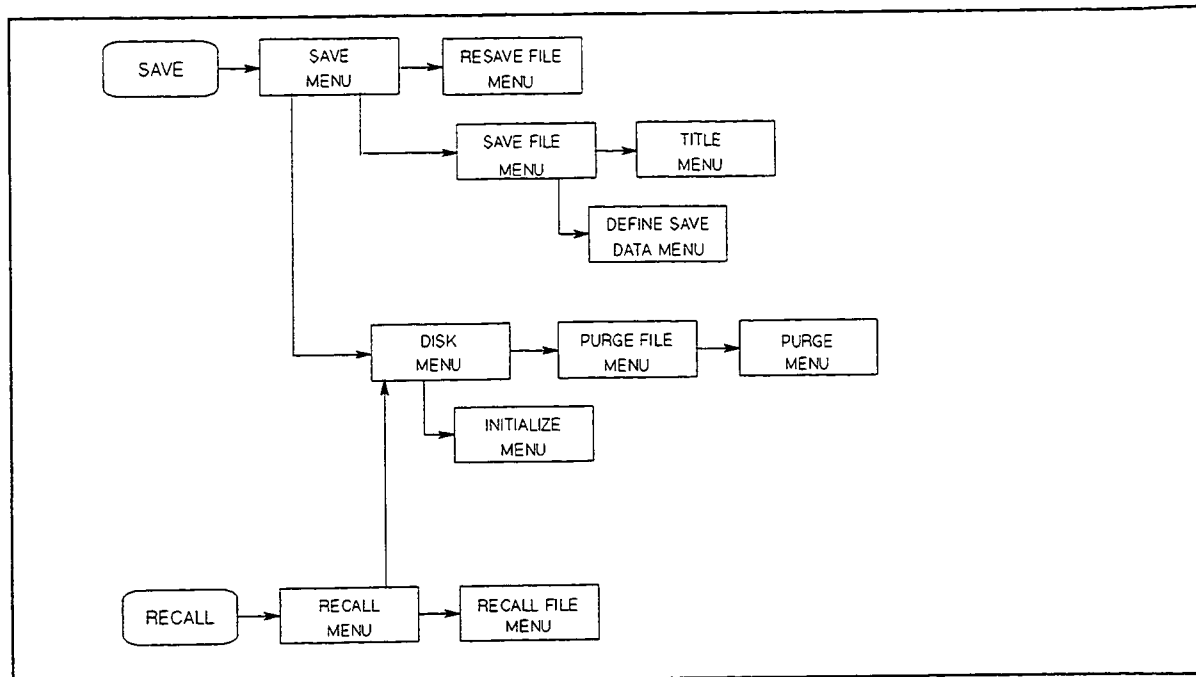

C2000004

Operation Softkey Menu Map (5 of 5)

Page E-3, "Figure E-2"

Delete Conversion More menu and MORE softkey label in the Conversion menu.

Page E-5, "Figure E-5"

Delete Pen menu and MORE softkey label in the Modify Colors More menu.

Page E-19, "Figure E-21"

Replace Figure E-21 with the following figure:

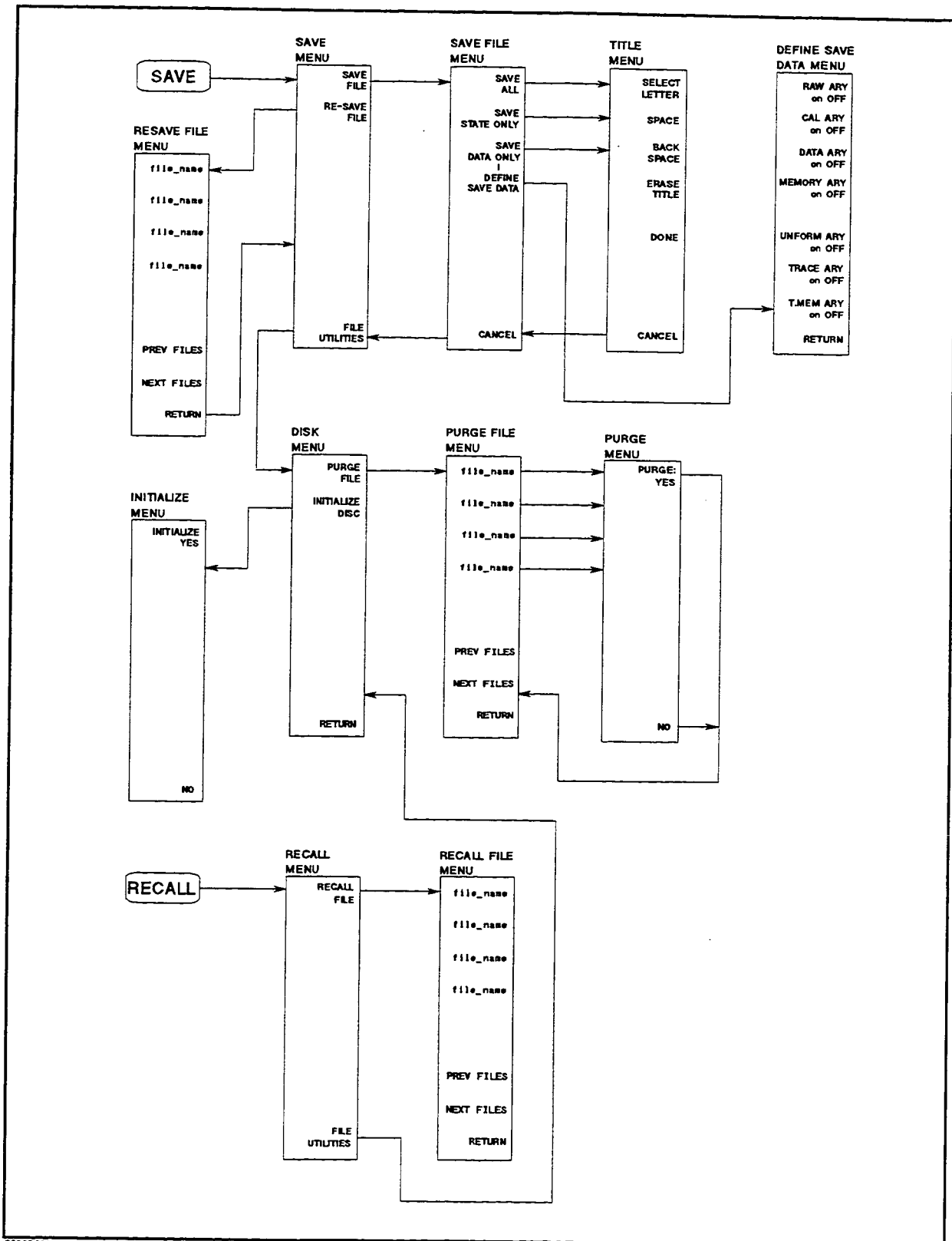

C200D001

Figure E-21. Softkey Menus Accessed from the **SAVE** and **RECALL** Keys

Page Message-3, "ERROR MESSAGES IN ALPHABETICAL ORDER"

Delete the following message.

106 CAN'T SAVE GRAPHICS WHEN COPY IN PROGRESS

Page Message-18, "ERROR MESSAGES IN NUMERICAL ORDER"

Delete the following message

106 CAN'T SAVE GRAPHICS WHEN COPY IN PROGRESS

CHANGE 1 FOR USER'S GUIDE

Page 5-12, "Disk Drive Tutorial"

Replace the description to the following description.

The HP 8751A's 3.5 inch built-in disk drive can be used to save instrument state and measurement data. Its format is LIF (logical interchange format), which is used for HP-9000 series. This section describes key features and the basic procedure for using the disk drive.

Page 5-12, "Saving Procedure"

Replace the description to the following description.

Saving Procedure

1. Insert a disk into the disk drive.
2. If the disk is *NEW*, press **SAVE** **FILE UTILITIES** **INITIALIZE DISC**, then **INITIALIZE YES** to initialize it in the LIF format.

Note

Initialization *destroys* all current data on a disk. You can NOT recover the data destroyed after initialization.



-
3. Press **SAVE** **SAVE FILE**.
 4. When the both of the instrument state and measured data are to be saved, press **SAVE ALL**.
When only the instrument state is to be saved, press **SAVE STATE ONLY**.
When only the measured data is to be saved, press **SAVE DATA ONLY**.
 5. Select the letters for the input file name.
 6. After input file name, press **SAVE DONE** to complete this.

Page 5-12, "Recalling Procedure (LIF Format Disk)"

Delete the following item from the note.

- **I**: means measured data in ASCII format.
- **G**: means graphical image of display in HP-GL file (ASCII).

Page 5-13, "Recall Procedure (DOS Format Disk)"

Delete this section.

Page 5-14, "Saving Display Image"

Delete this section.

Page 5-13, "Move Working Directory"

Delete this section.

CHANGE 2 FOR REFERENCE MANUAL

Page 11-1, "STORAGE DEVICES"

Delete this section.

Page 11-5, "Auto Recall Function"

Replace the description to the following description.

Auto Recall Function

When the analyzer is turned on, it looks for a file named "AUTOREC", and if found, the analyzer automatically reads the file to retrieve its data.

Page 11-14, "Figure 11-5."

Replace Figure 11-5 with the following figure:

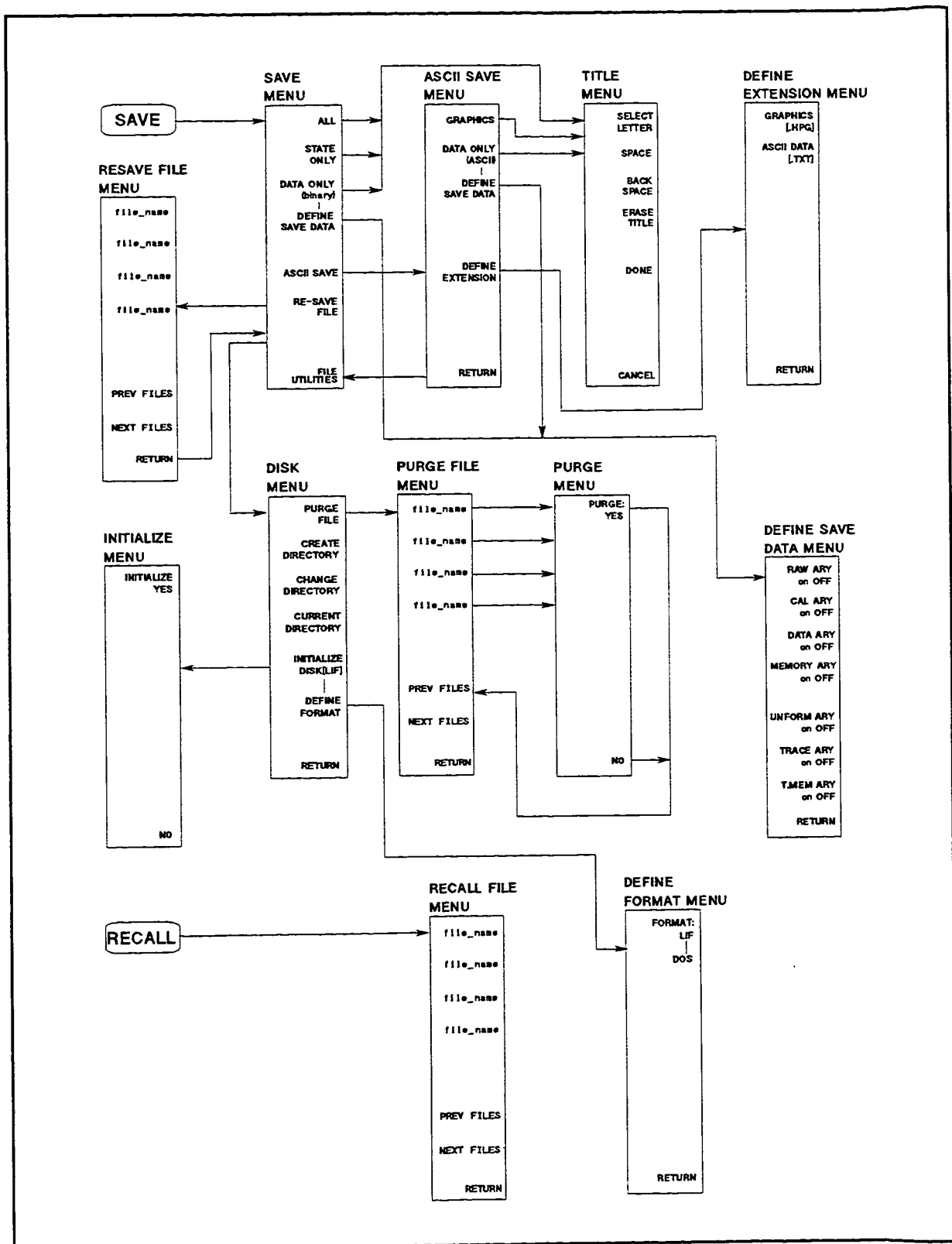

C200D006

Figure 11-5. Softkey Menus Accessed from the **SAVE** and **RECALL** Keys

Page 11-15 ,“Save Menu”

Replace the Save Menu description to the following description:

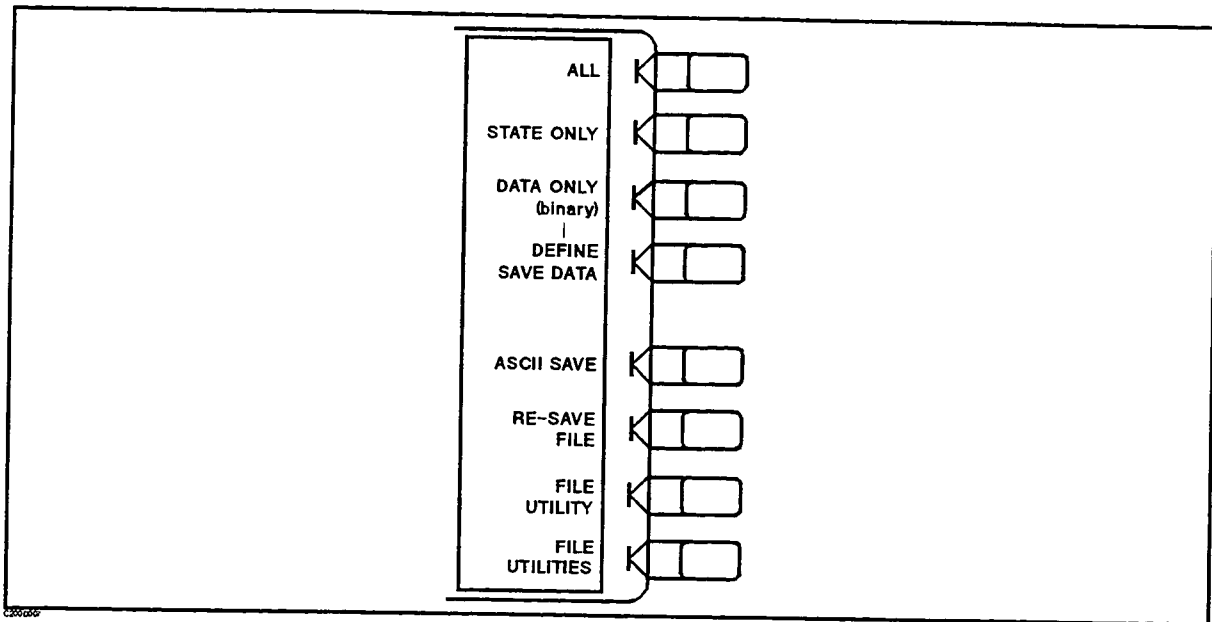

Figure 11-6. Save Menu

ALL (SAVDAL) specifies saving the instrument states, the “data arrays”, and the “memory arrays”.

STATE ONLY (SAVDSTA) specifies saving only the instrument states and the calibration coefficients.

DATA ONLY (binary) (SAVDDAT) specifies saving the internal data arrays which are defined using the **DEFINE SAVE DATA** key.

DEFINE SAVE DATA provides the define save data menu, which selects the applicable data arrays to be saved.

ASCII SAVE leads to the ASCII Save Menu, from which to save data or graphic screen images to an ASCII file.

RE-SAVE FILE (RESAVD) leads to the Re-save File menu, to update a file which is already saved.

FILE UTILITIES provides the disk menu, which initializes a new disk, and purges a file from a disk.

Page 11-16 , "Title Menu"

Replace the Title Menu description to the following description:

This menu defines the file name to be saved.

The file name can be up to eight characters long, alphabetic (upper and lower case), numeric, special characters, see Table of Valid Characters in the file names section. If more than eight characters are entered, the last character is over written each time you type in a character.

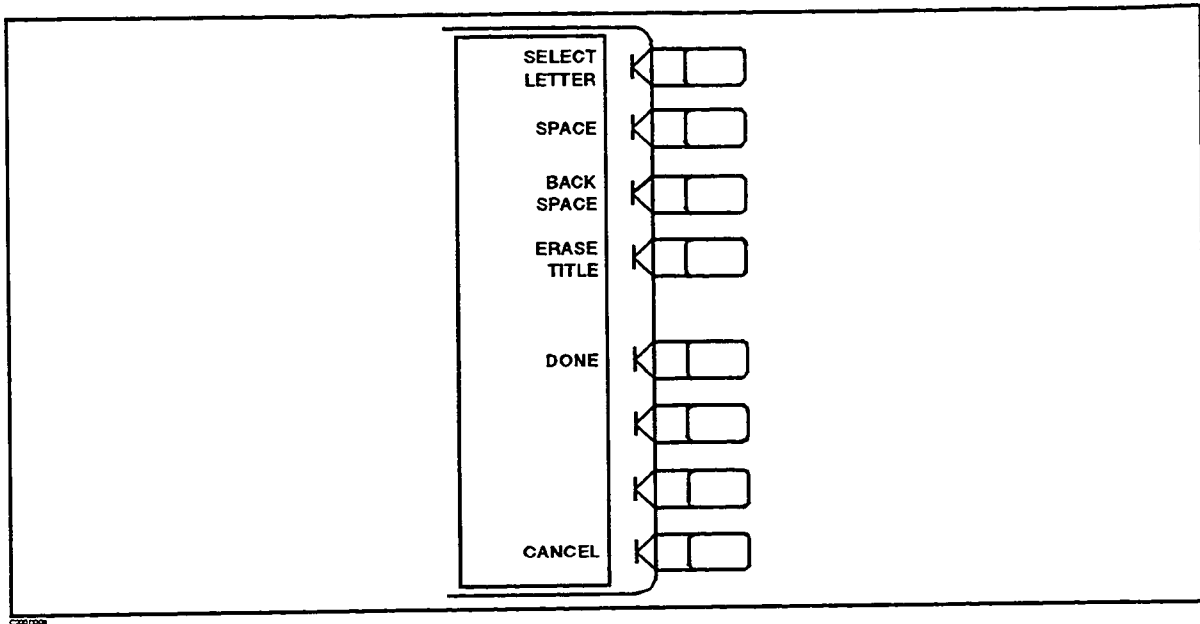

Figure 11-7. Title Menu

SELECT LETTER The active entry area displays the letters of the alphabet, numerals, etc. To define a title, rotate the knob until the arrow ↑ points to the desired letter, then press **SELECT LETTER**. Repeat this procedure until the file name is defined, for a maximum of eight characters.

SPACE Don't use this key because LIF and DOS file formats don't allow spaces in file names.

BACK SPACE deletes the last character entered.

ERASE TITLE deletes the entire file name.

DONE saves the data specified in the define save menu and returns to the Save menu.

CANCEL quits this menu without saving the file, and returns to the Save menu.

Page 11-20, "Re-save File Menu"

Replace the Re-save File Menu description to the following description:

This menu lists the sorted file names, which were previously saved, on the softkey label area and allows updating the file with the current instrument states or data.

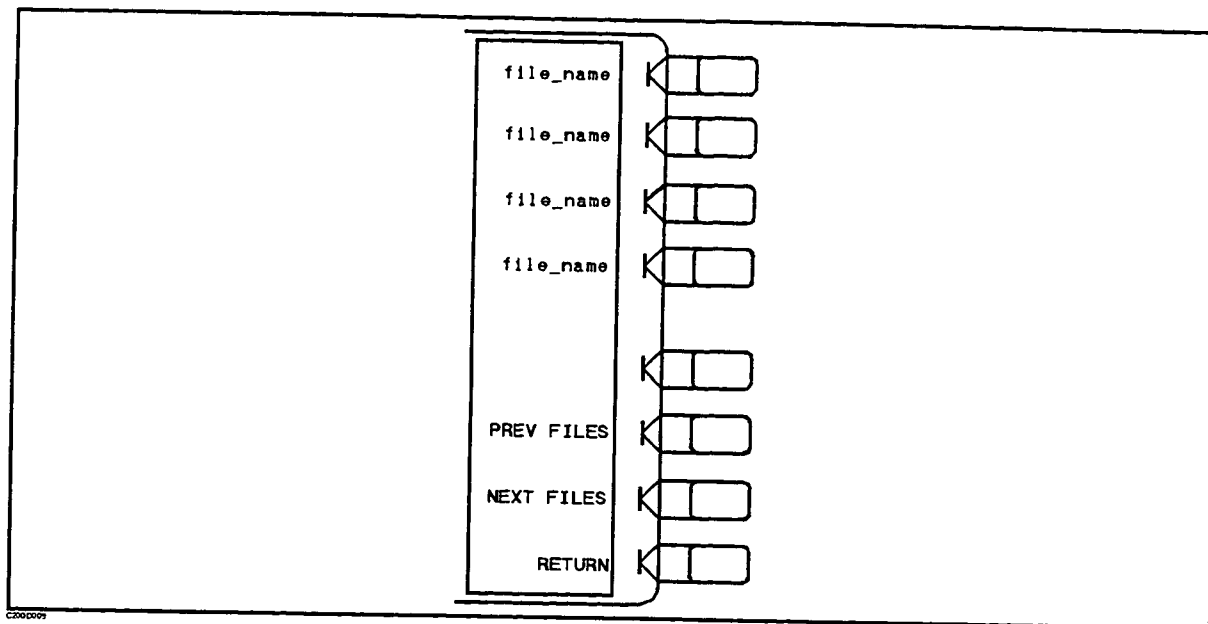

Figure 11-11. Re-save File Menu

file_name updates the file previously saved with the current instrument states or data. The data group to be saved is determined by the file name's extension. Refer to "File Names" in Chapter 11 for more details about file name extensions.

PREV FILES displays the previous file names in the softkey label to re-save data.

NEXT FILES displays the next file names in the softkey label to re-save data.

RETURN returns the save menu.

Note



For DOS formatted disks, all available files and directories under the current directory are listed. A "\ " is attached at the end of the label if the softkey label shows a directory name.

Pressing a softkey directory listing label changes the current directory to the directory selected, and the files and directories under the new directory are listed.

Page 11-21, "Disk Menu"

Replace the Disk Re-save File Menu description to the following description:

This menu provides the Purge File and Initialize menus from which to purge a file and initialize a disk, respectively.

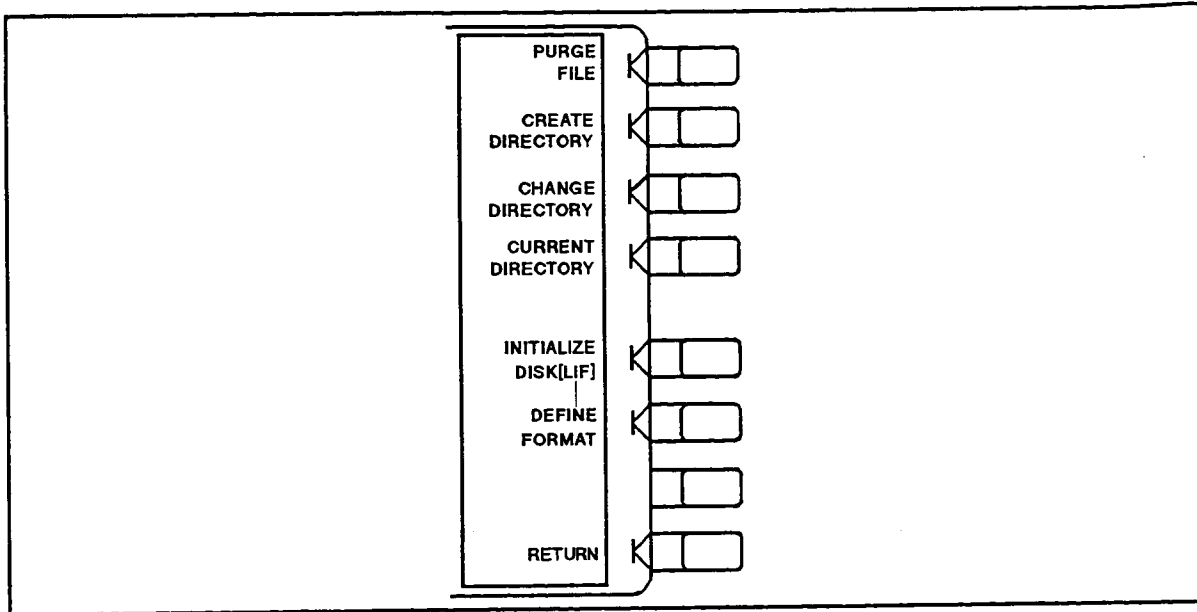

Figure 11-12. Disk Menu

PURGE FILE (PURG) leads to the Purge File menu, from which to remove a file saved on the disk.

CREATE DIRECTORY (CRED) specifies creating a new directory in a DOS format disk. This function is not available for LIF files.

CHANGE DIRECTORY (CHAD) specifies changing the current directory of a DOS format disk. This function is not available for LIF files.

CURRENT DIRECTORY (CURD) displays the current directory of a DOS format disk. If the disk format is LIF, this key displays nothing.

INITIALIZE DISK [] (INID) leads to the Initialize menu. A new disk must be initialized before data is stored on it. The disk can be formatted in either LIF or DOS format.

DEFINE FORMAT leads to the Define Format menu from which to select the disk format to be used when initializing a new disk.

RETURN returns to the Save menu.

Page 11-22, "Purge File Menu"

Replace the Disk Purge File Menu description to the following description:

This menu lists the sorted file names, which were previously saved, on the softkey label area and allows selecting a file to be removed from the disk.

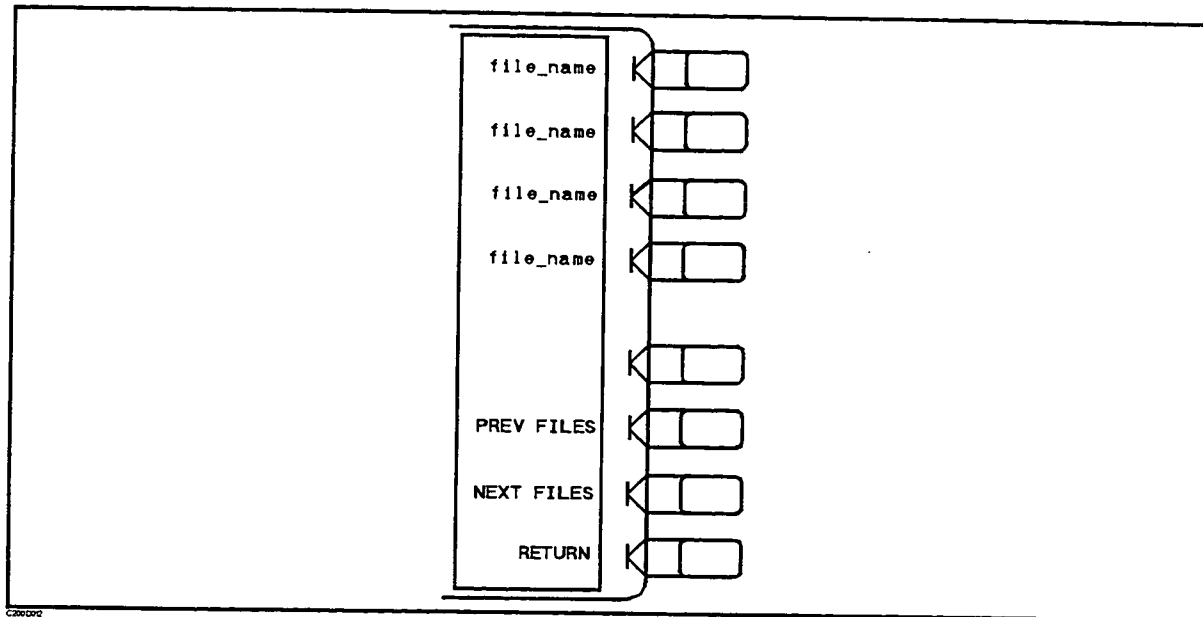

Figure 11-13. Purge File Menu

file_name selects the file name to be removed and provides the purge menu to remove the selected file.

PREV FILES displays set of previous file names in the softkey label area.

NEXT FILES displays next file names in the softkey labels area.

RETURN returns to the disk menu.

Note



All available files and directories under the current directory are listed for DOS format disk. A "\ " is attached at end of the label if the softkey label represents a directory name.

Pressing a softkey listing directory changes the current directory to the directory pressed, the files and directories under the new directory are then listed.

Note



Before recalling a binary data file, set the trigger (under **MENU**) to hold to avoid only momentary recall of data.

Add the following section after the Disk menu.

Define Format Menu

Selects the initialization format for a floppy disk. The LIF format is compatible with HP 9000 series 200/300 computers and the DOS format is compatible with the IBM PC and its compatibles.

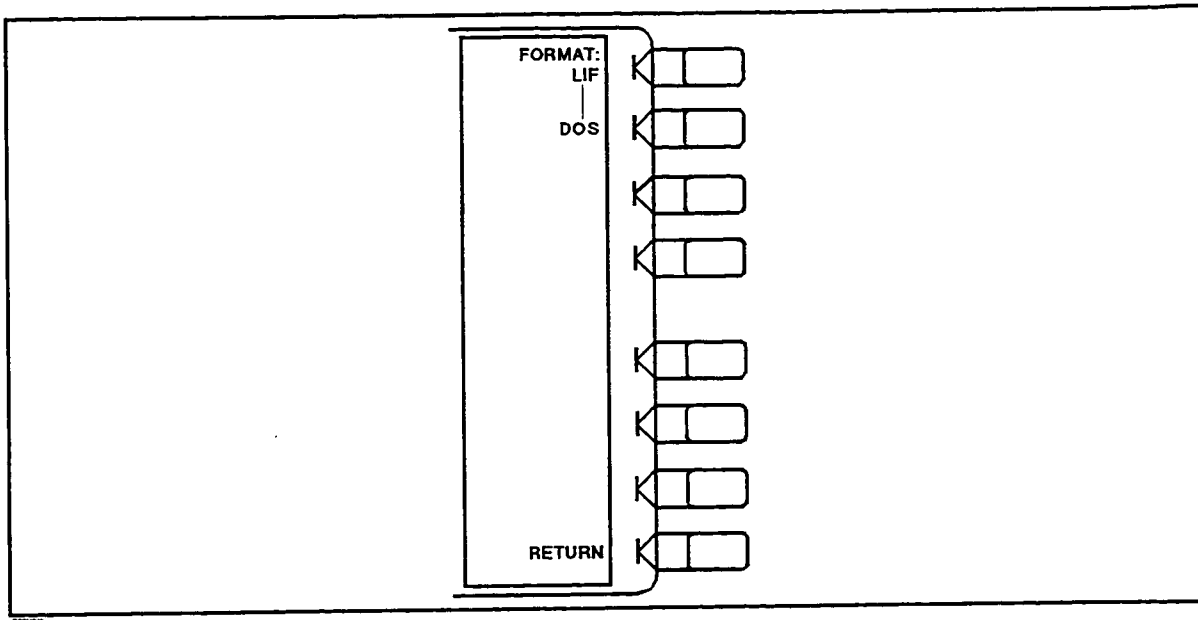

Define Format Menu

FORMAT: LIF (DSIFLIF) selects the LIF initialization format.

DOS (DISFDOS) selects the DOS initialization format.

RETURN returns to the Disk menu.

Page 11-25, "Recall File Menu"

Replace the Recall File Menu description to the following description:

This menu lists sorted file names, which were previously saved, on the softkey label for selection, and recalls the selected file. The data group to be recalled depends on the file name extension or suffix. Refer to "File Names" in Chapter 11 for more detail.

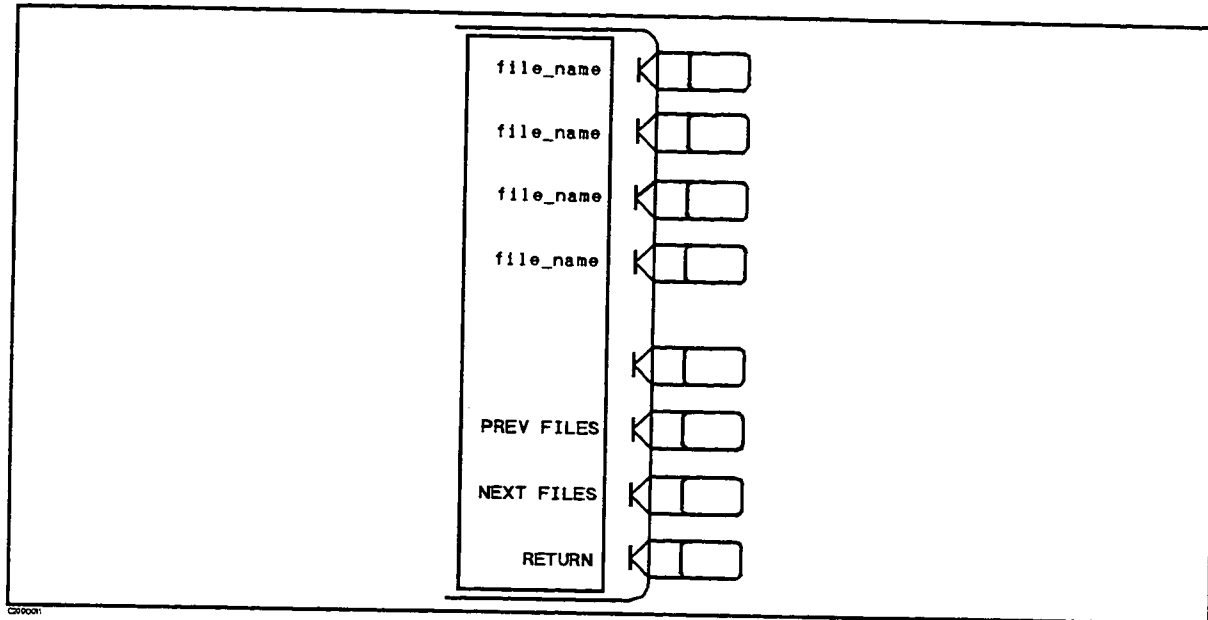

Figure 11-16. Recall File Menu

file_name selects a file to be loaded and loads the instrument state or data.

PREV FILES displays the previous set of file names on the softkey label to load data.

NEXT FILES displays the next set of file names on the softkey label to load data.

Note



All available files and directories under the current directory are listed for a DOS formatted disk. A "\ " is attached at end of the label if the softkey label shows a directory name.

Pressing a softkey listing directory changes the current directory to the directory name selected, the files and directories under new directory are then listed.

Replace Figure E-21 with the following figure:

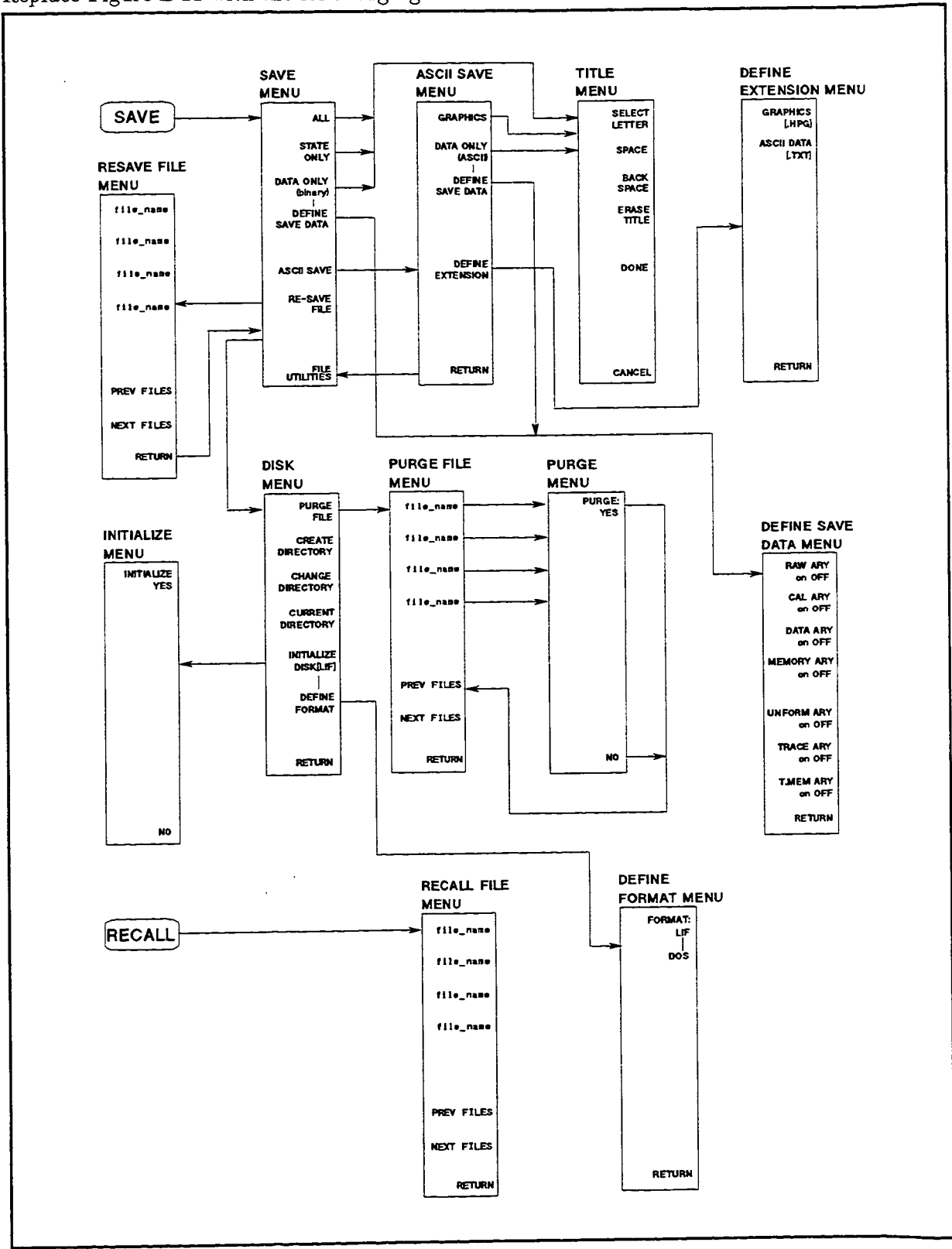

C2000006

Figure E-21. Softkey Menus Accessed from the **SAVE** and **RECALL** Keys

D: Manual Changes

Page B-5, "Figure B-5"

Replace Figure B-5 to the following one:

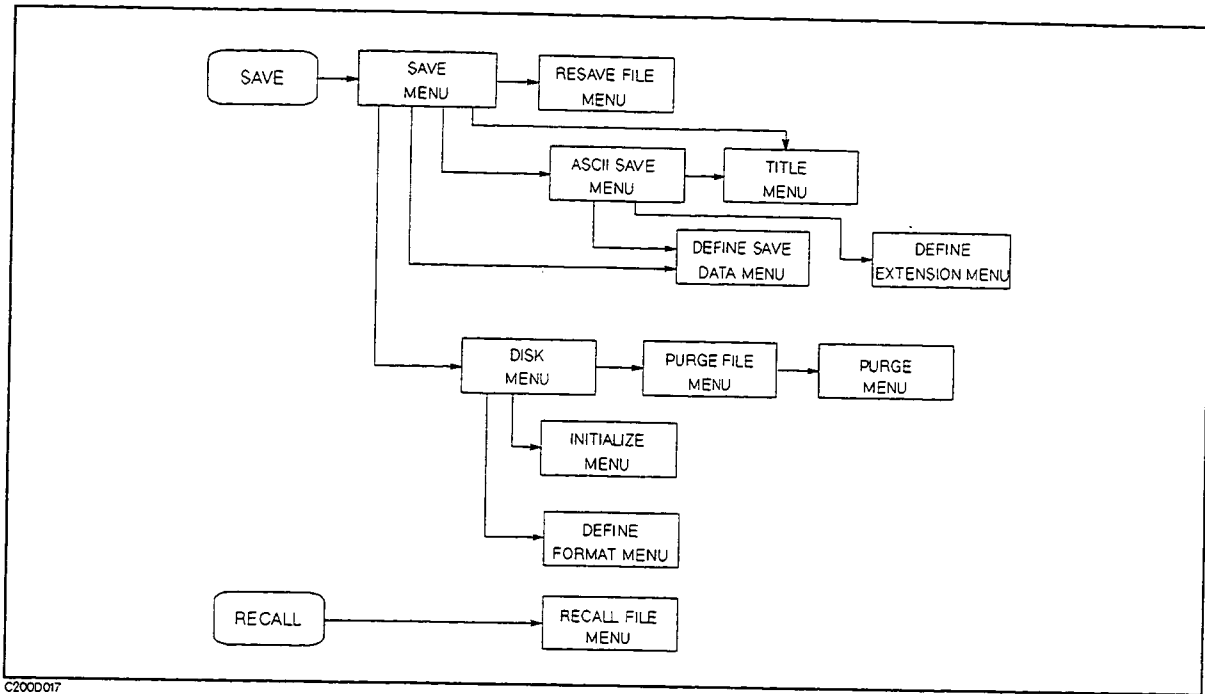

Figure B-5. Operation Softkey Menu Map (5 of 5)

CHANGE 2 FOR USER'S GUIDE

Page 5-12, "Disk Drive Tutorial"

Change as follows:

Disk Drive Tutorial

The HP 8751A's 3.5 inch built-in disk drive can be used to save instrument states, measurement data, Instrument BASIC programs, and graphic images, for details refer to Chapter 11 in the *REFERENCE* section of the *Operation Manual*. The built-in disk drive supports the Logical Interchange Format (LIF) which is used for HP 9000 series computers and the DOS file format which is used for IBM-PC and compatible computers. This section describes the basic procedure for using the HP 8751A's disk drive.

Saving Procedure

1. Insert a disk into the disk drive and press **SAVE**.
2. If the disk is *NEW*, press **FILE UTILITIES DEFINE FORMAT**. When you want to use this disk for LIF files, press **LIF RETURN INITIALIZE DISK [LIF]**, then **INITIALIZE YES** for LIF initialization. When you want to use this disk for DOS files, press **DOS RETURN INITIALIZE DISK [DOS]**, and then **INITIALIZE YES** for DOS initialization.

Note



Initialization *destroys* all current data on a disk. You can NOT recover the data once it has been destroyed by the initialization process.

3. Press **SAVE**.
4. The instrument will save the file to the current working directory when using DOS format. If you want to save the file in another directory, move the working directory. Refer to "Change Working Directory".
5. When both instrument state and measurement data are to be saved, press **ALL**.
When only the instrument state is to be saved, press **STATE ONLY**.
When only binary format measurement data is to be saved, press **DATA ONLY (binary)**.
When only ASCII format measurement data is to be saved, press **ASCII SAVE DATA ONLY (ASCII)**.
6. Select letters for the input file name.
7. After entering the file name, press **DONE** to complete this task.

CHANGE 3 for General Information

Page 2-5, Dynamic Accuracy

- Change as follows:

Dynamic Accuracy (At $23 \pm 5^\circ\text{C}$, 20 Hz bandwidth, Freq. ≥ 1 kHz)

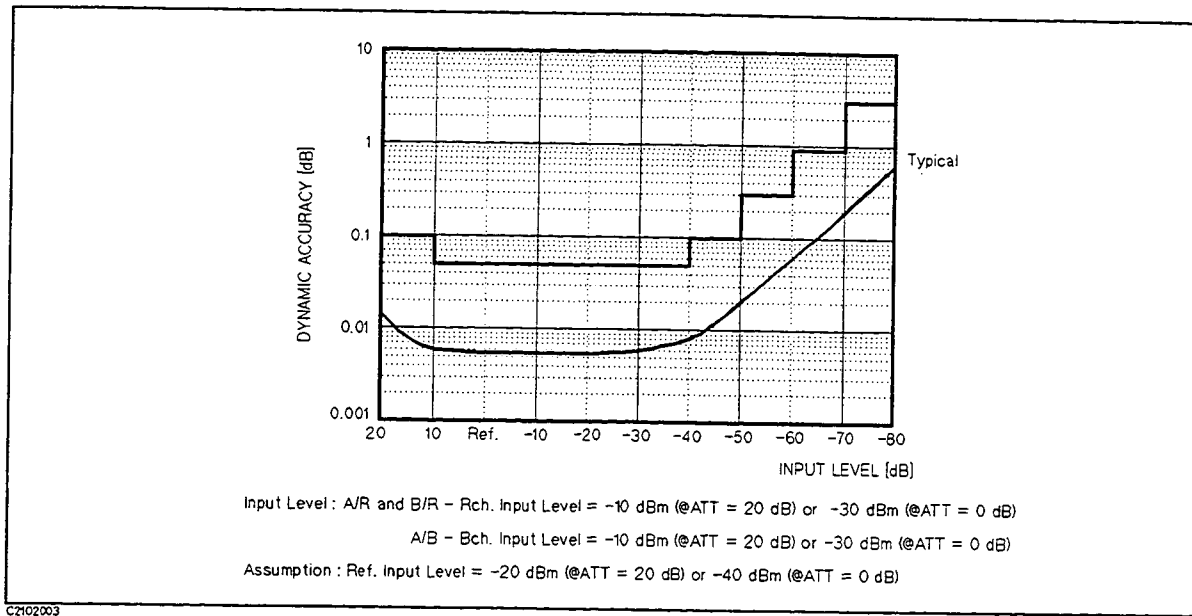
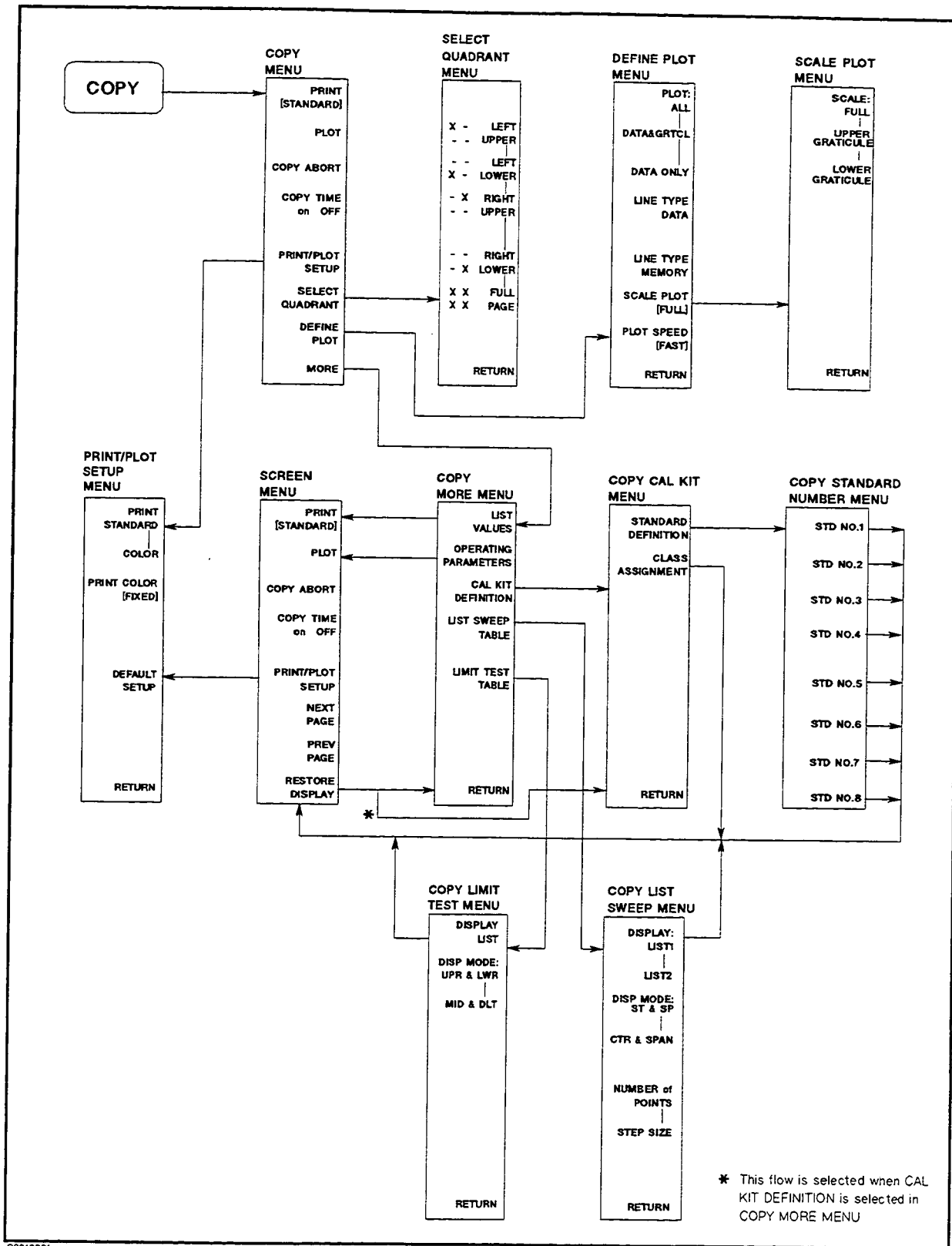

Figure D-1. Dynamic Accuracy (Amplitude)



C2010001

Figure 10-1. Softkey Menus Accessed from the **COPY** Key

Page 10-5, Copy Menu

- Delete `CONFIG PLOT`

Page 10-5, Copy Menu

- Add the following description:

`COPY TIME on OFF` (COPTON, COPTOFF) turns the “time stamp” on or off for a print or plot. When you select print, the time and date are printed out first, followed by the information shown on the display. When you select plot, the time and date are plotted on the message area. Refer to “`SYSTEM` KEY” in Chapter 9 for setting the internal clock.

Page 10-18, Configure Plot Menu

- Delete Configure Plot Menu

Page 10-19, Configure Plot More Menu

- Delete Configure Plot More Menu



Softkey Tree

E Softkey Tree

STIMULUS BLOCK

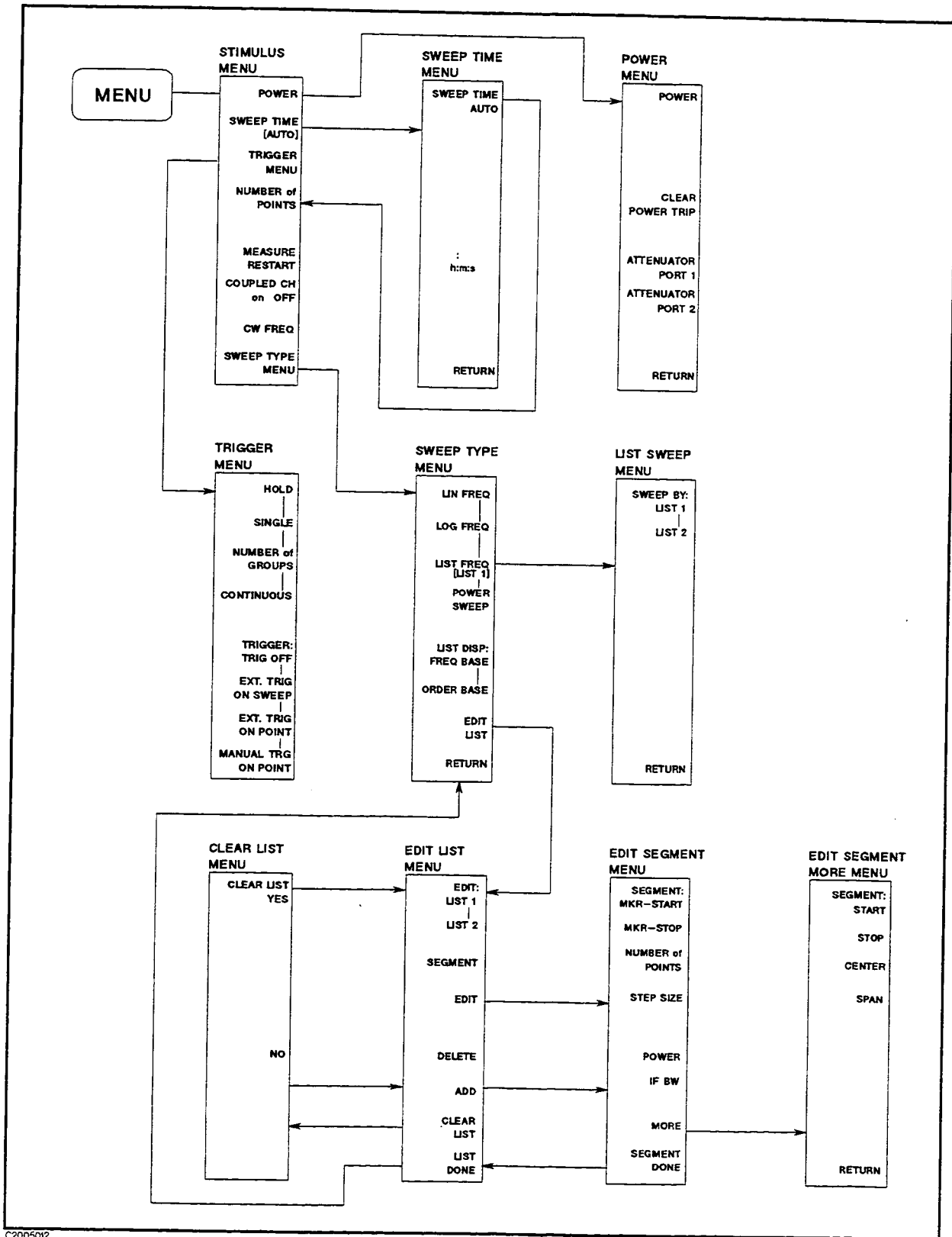

C2005012

Figure E-1. **MENU** key

RESPONSE BLOCK

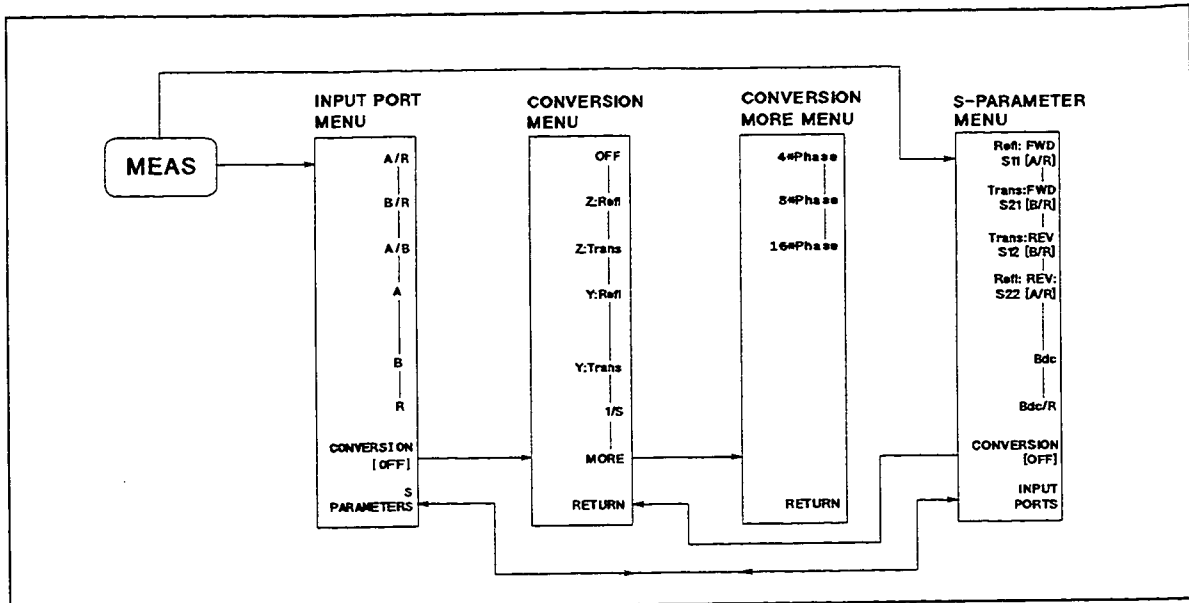

C2006028

Figure E-2. **MEAS** Key

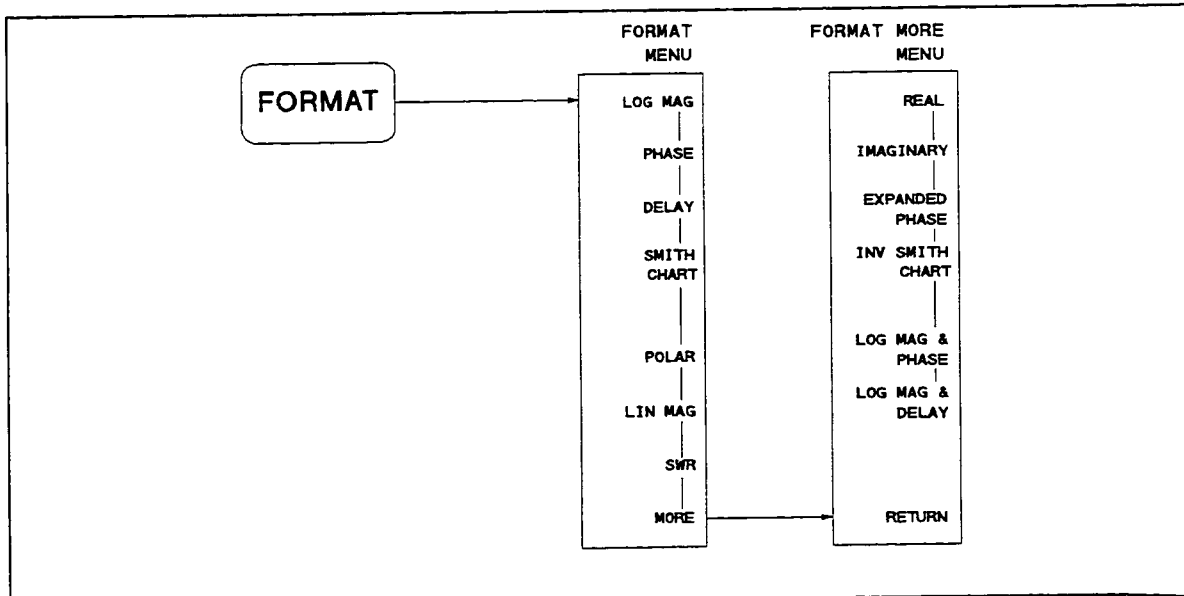

C2006029

Figure E-3. **FORMAT** Key

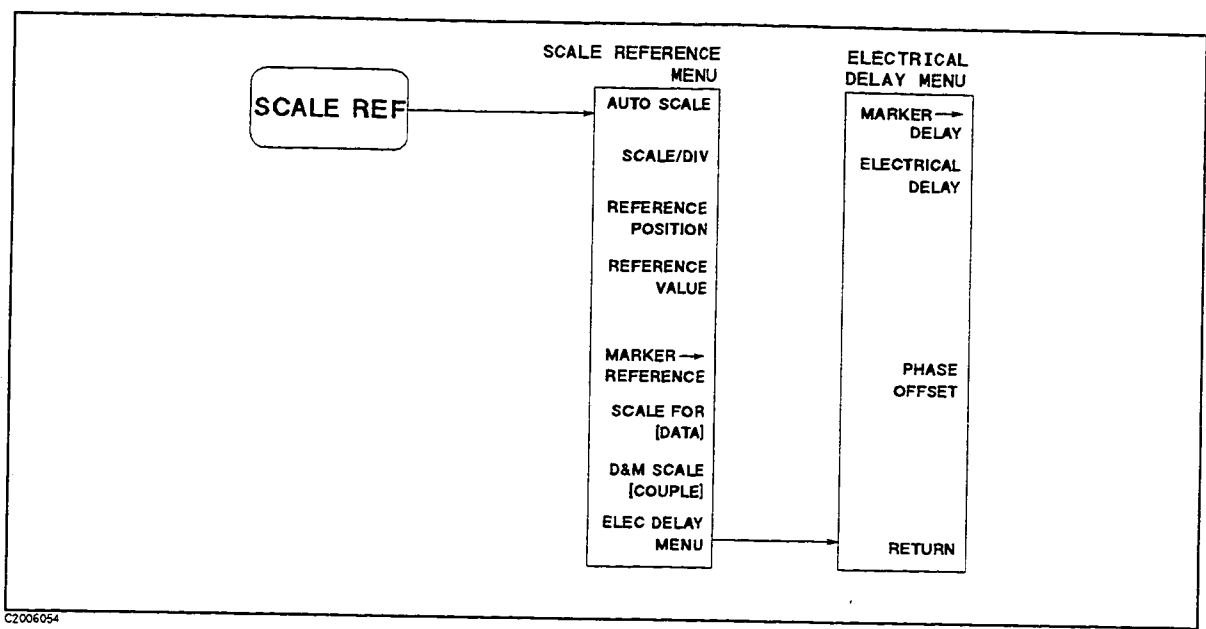

C2006054

Figure E-4. **SCALE REF** Key

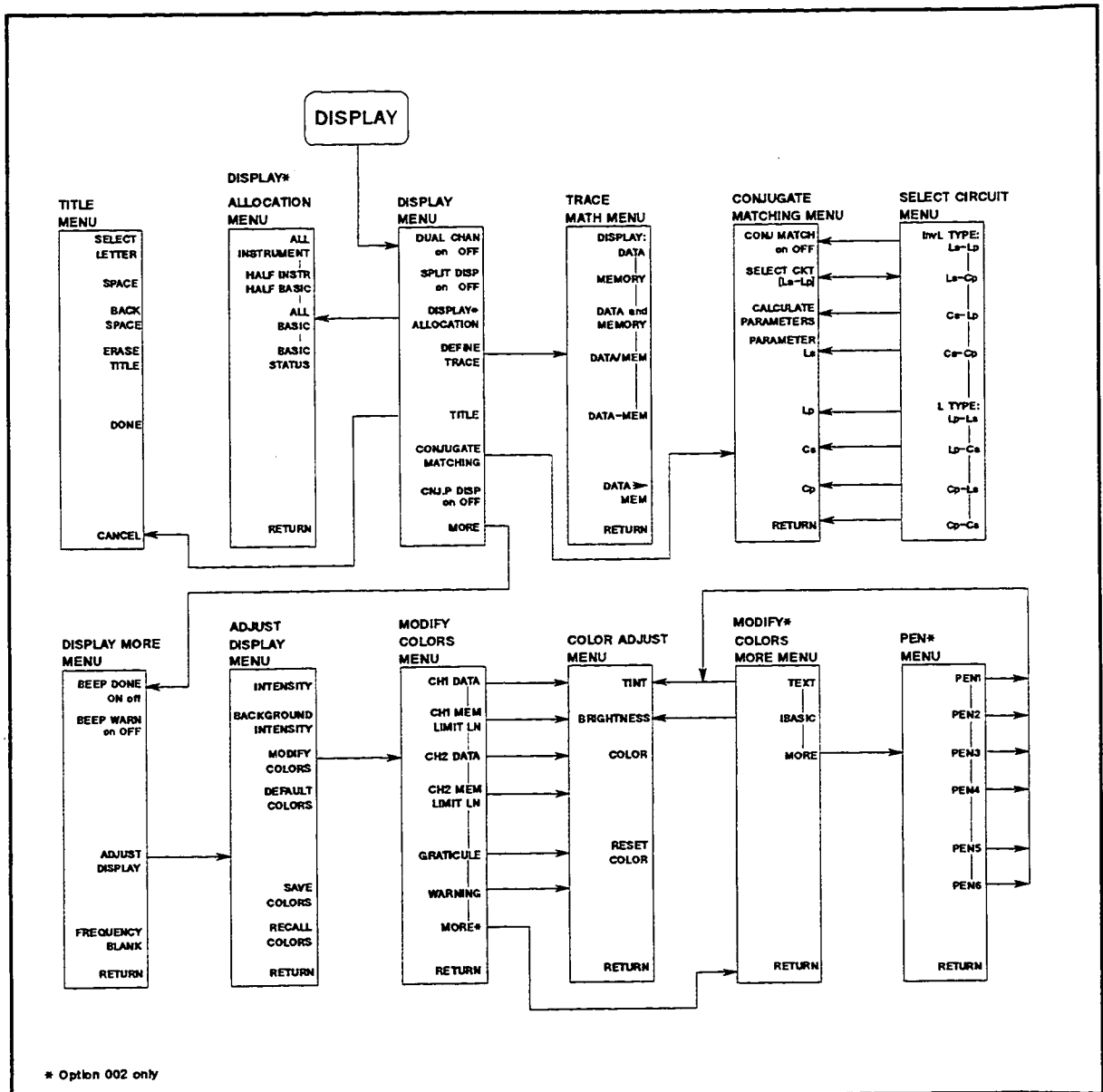

C2006031

Figure E-5. **DISPLAY** Key

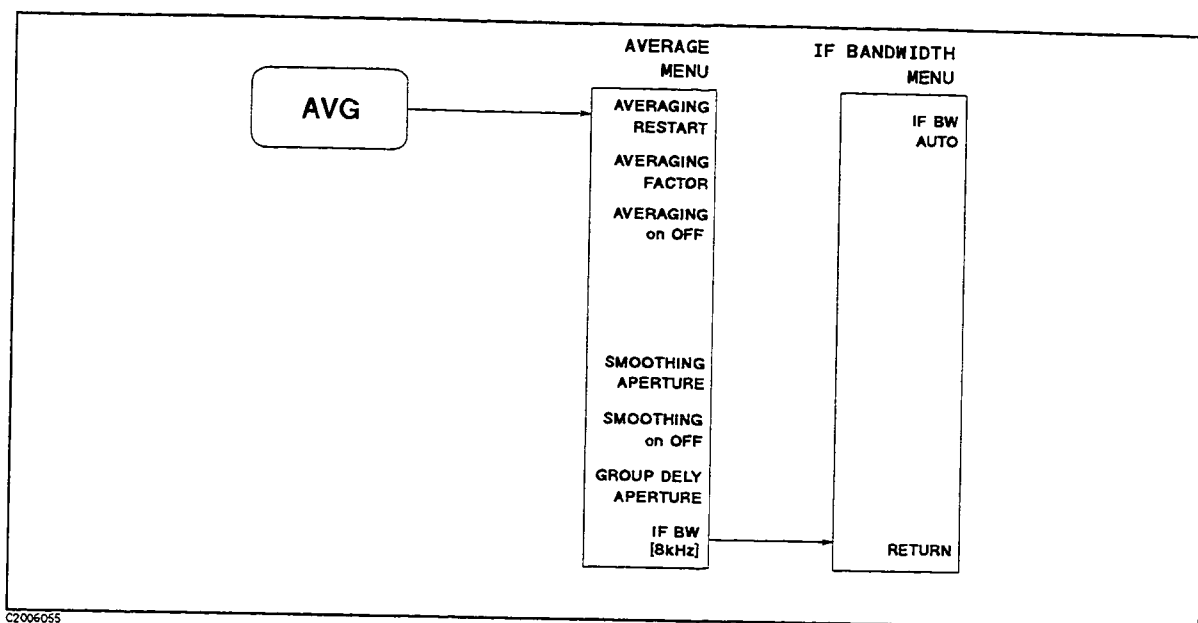
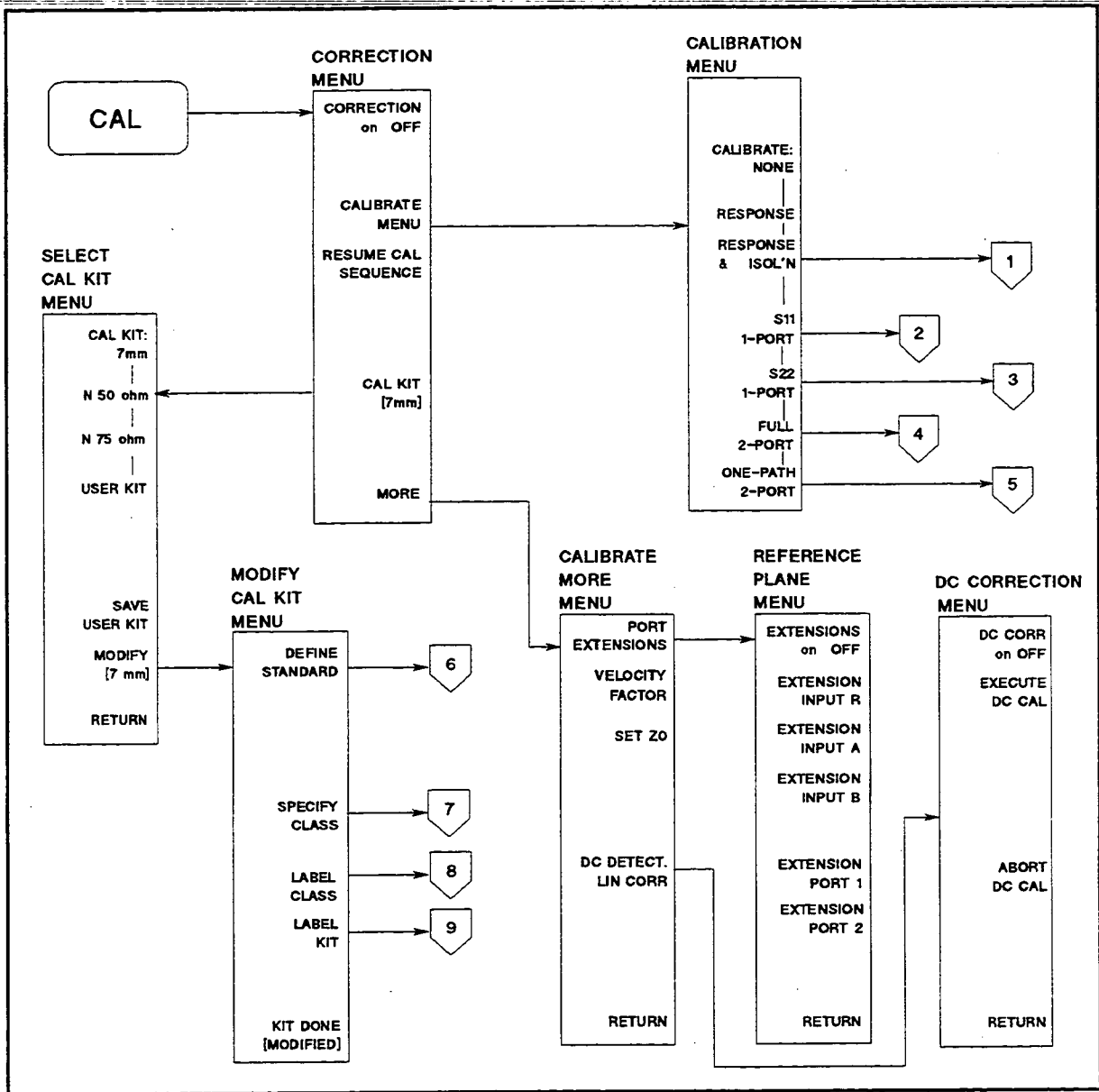

Figure E-6. **AVG** Key



C2007013

Figure E-7. **CAL** Key

E: Softkey Tree

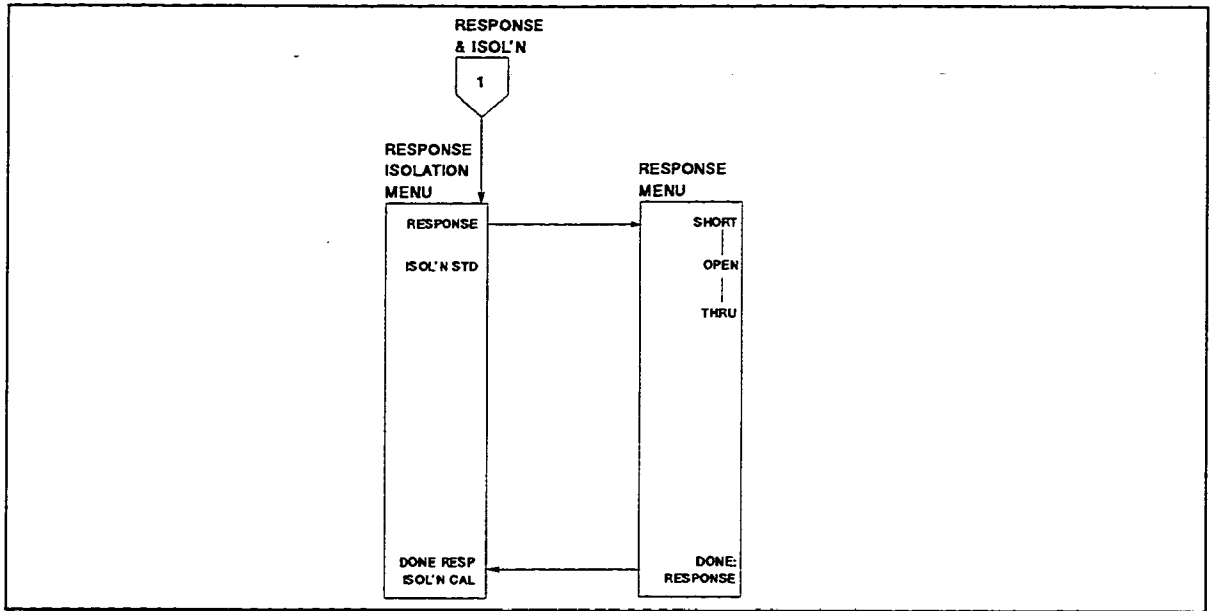

C2007006

Figure E-8. **CAL** Key

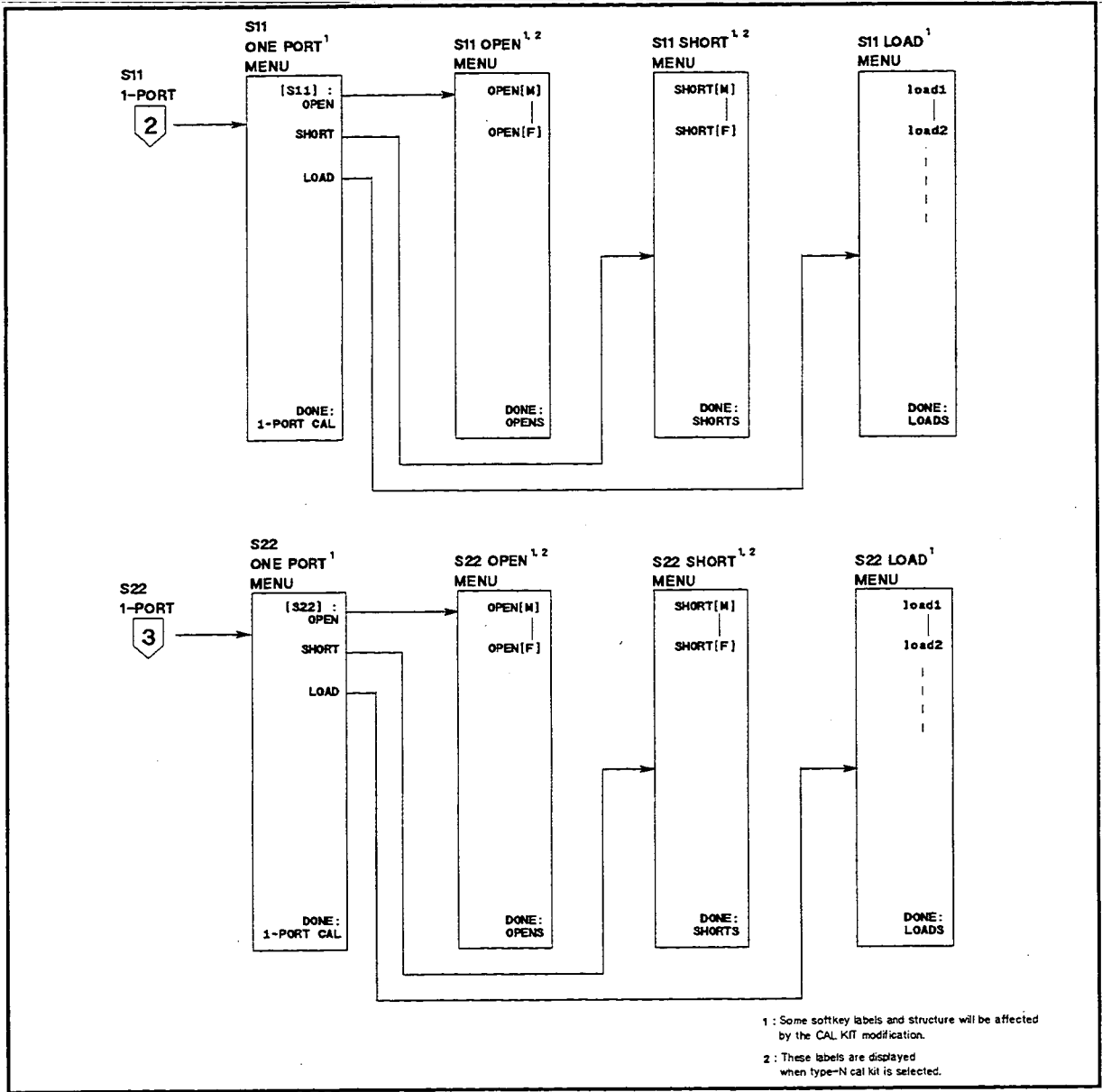

C2007007

Figure E-9. CAL Key

E: Softkey Tree

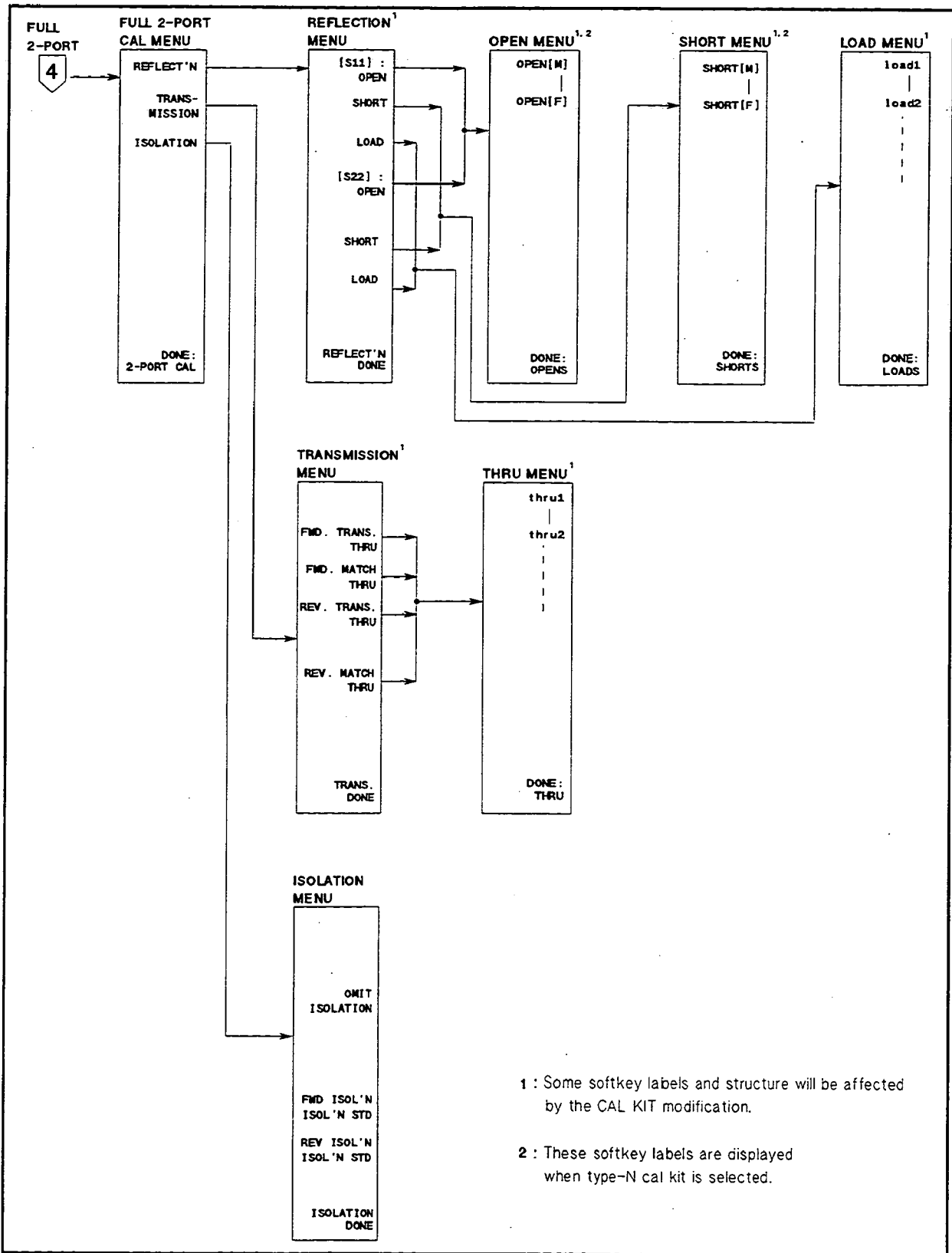

C2007008

Figure E-10. **CAL** Key

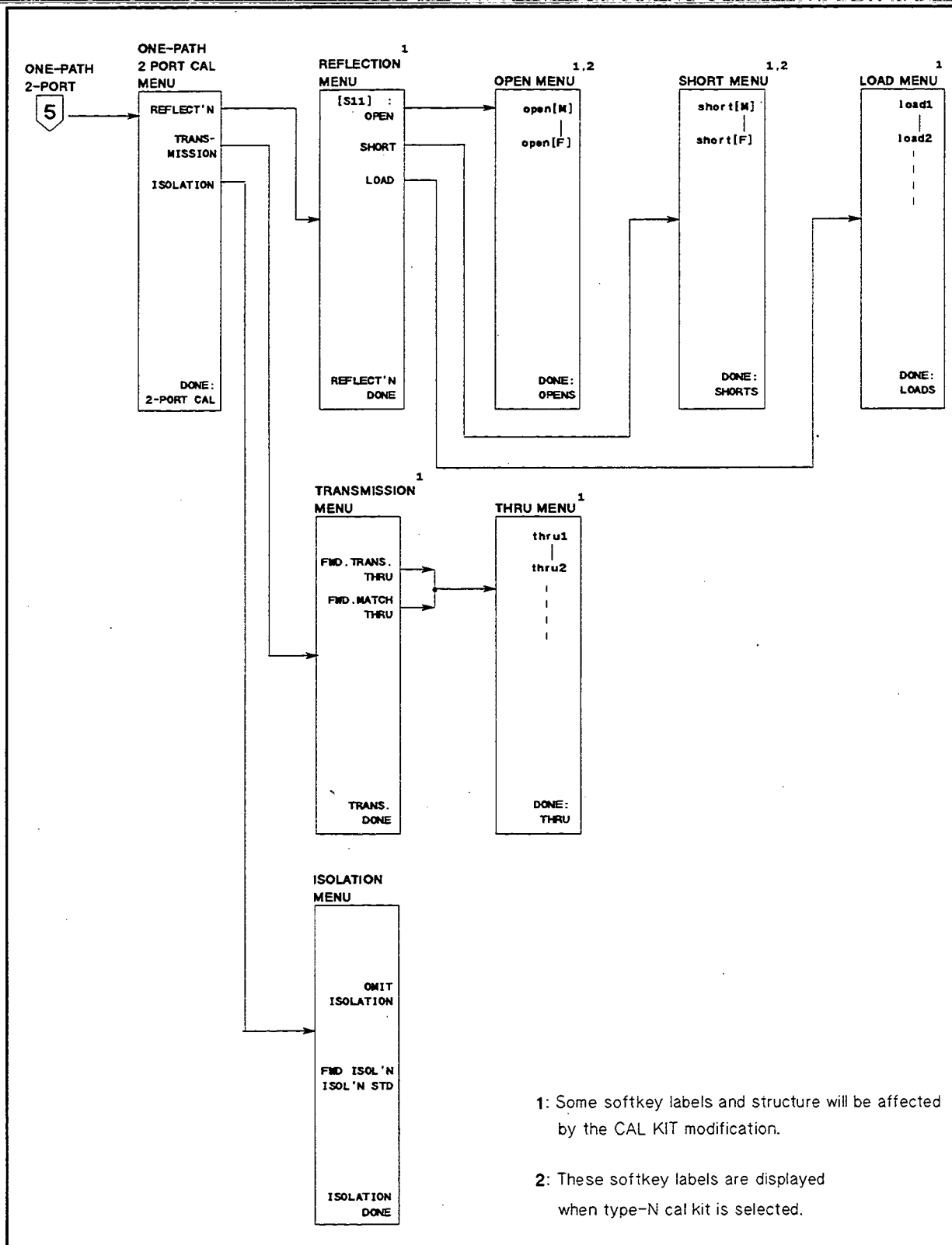

C2007009

Figure E-11. **CAL** Key

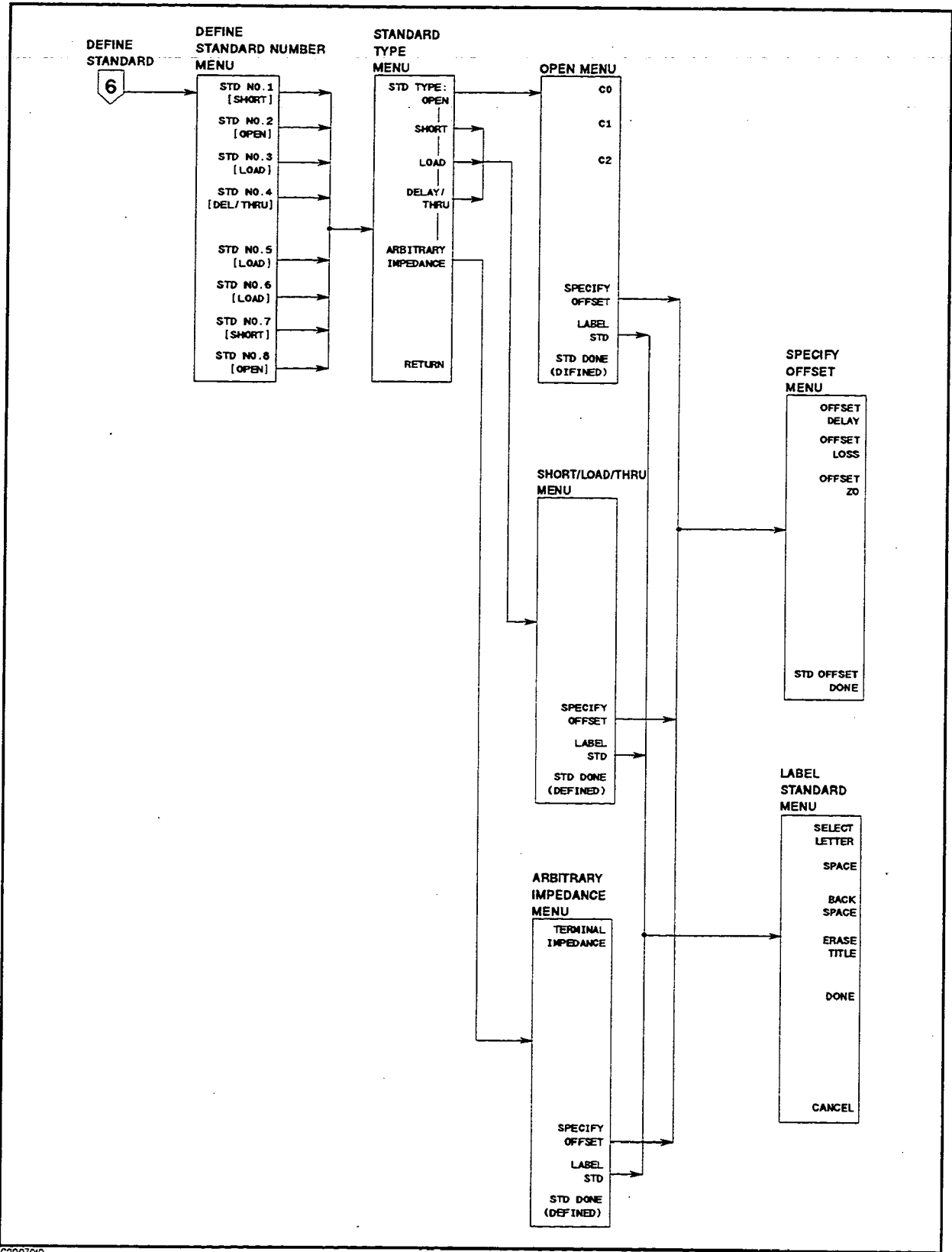

C2007010

Figure E-12. CAL Key

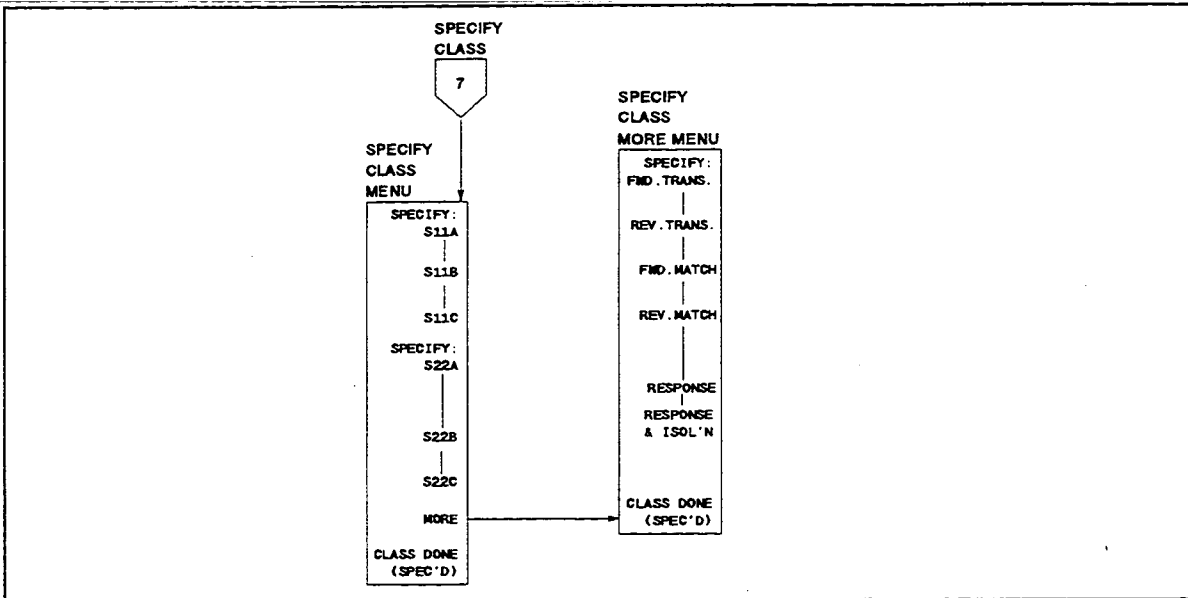

C200701

Figure E-13. **CAL** Key

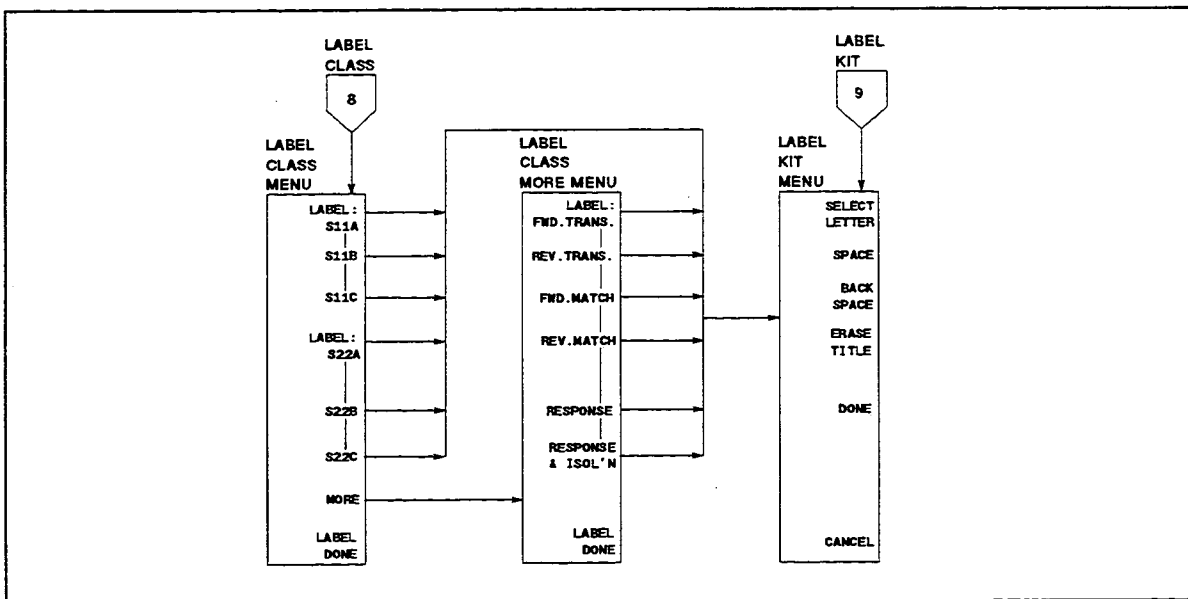

C200702

Figure E-14. **CAL** Key

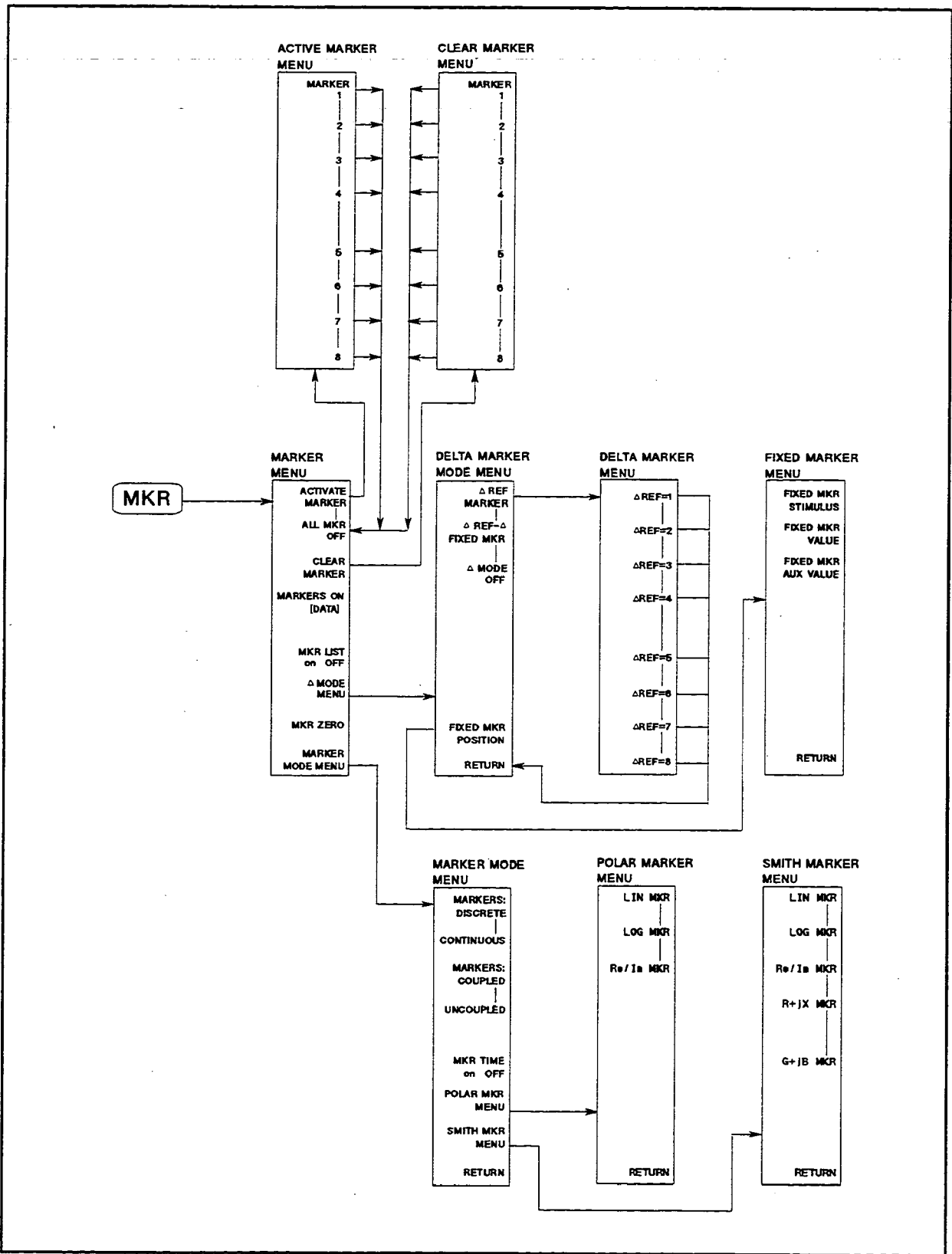

C2008017

Figure E-15. **MKR** Key

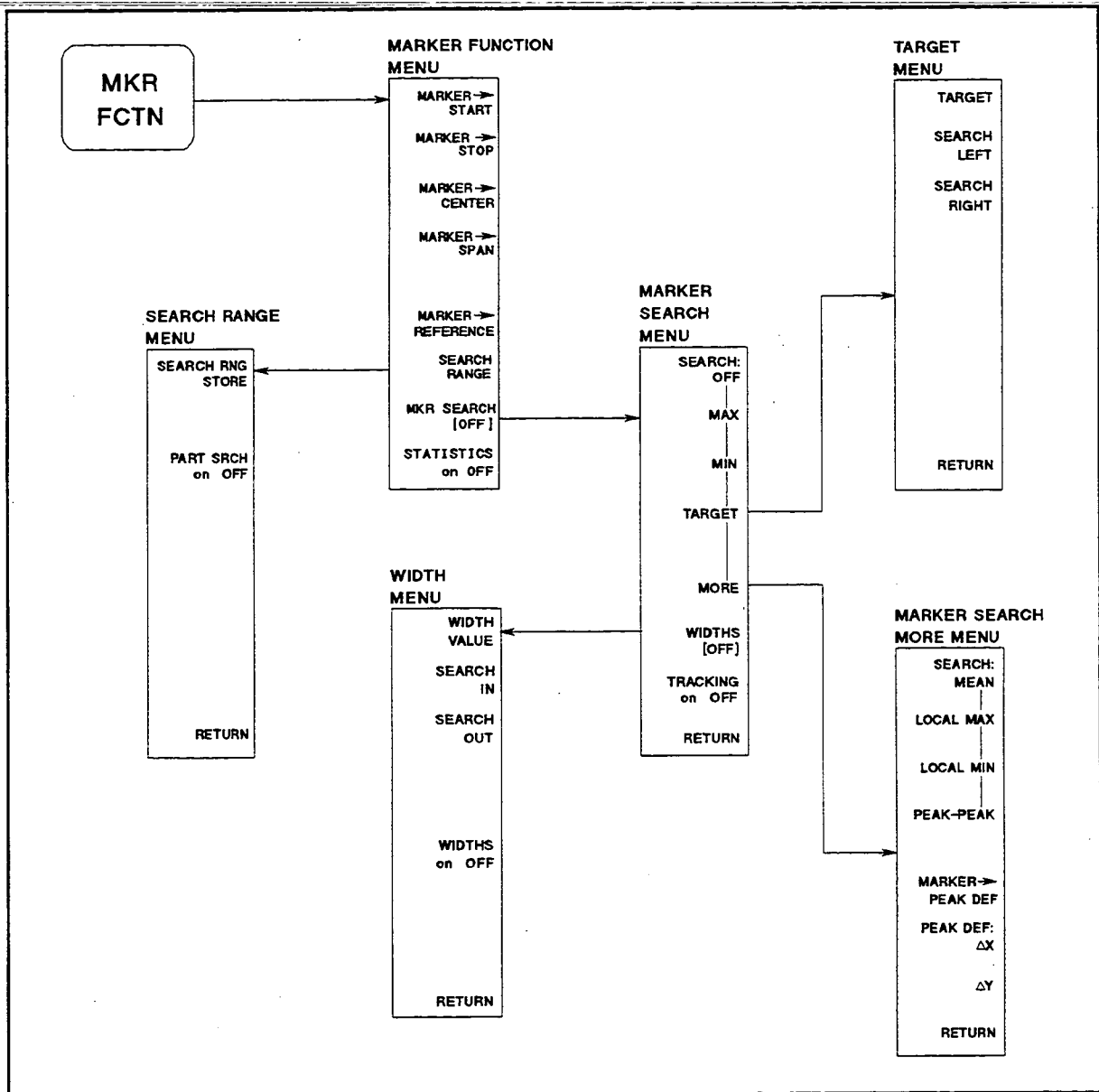

C2008018

Figure E-16. MKR FCTN Key

INSTRUMENT STATE FUNCTION BLOCK

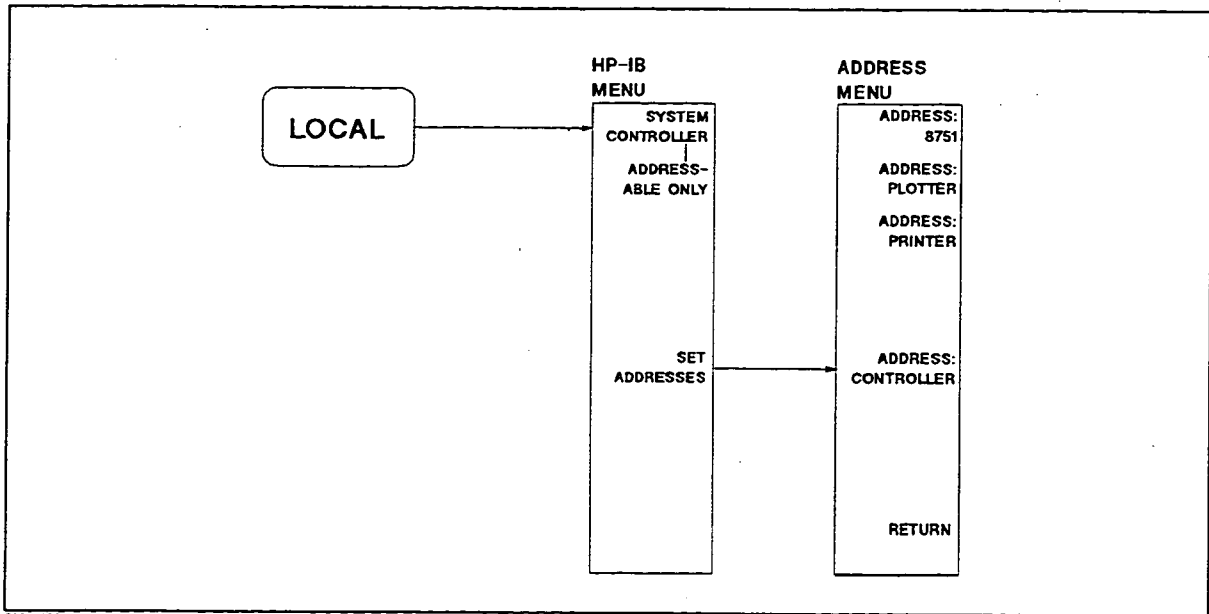

C2009002

Figure E-17. LOCAL Key

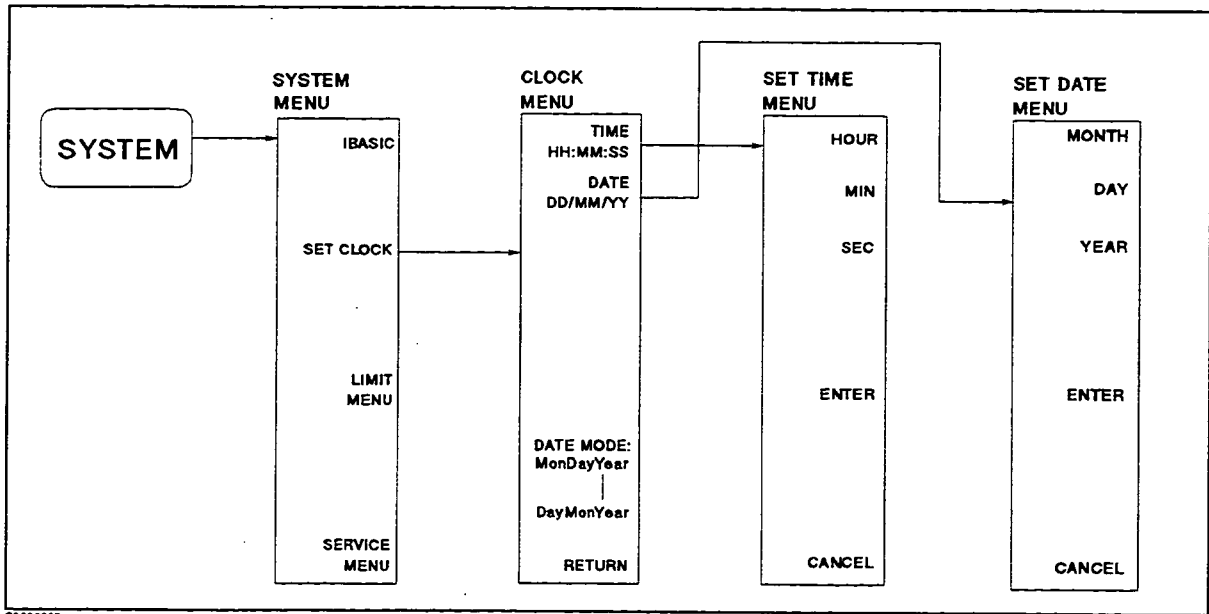

C2009020

Figure E-18. SYSTEM Key

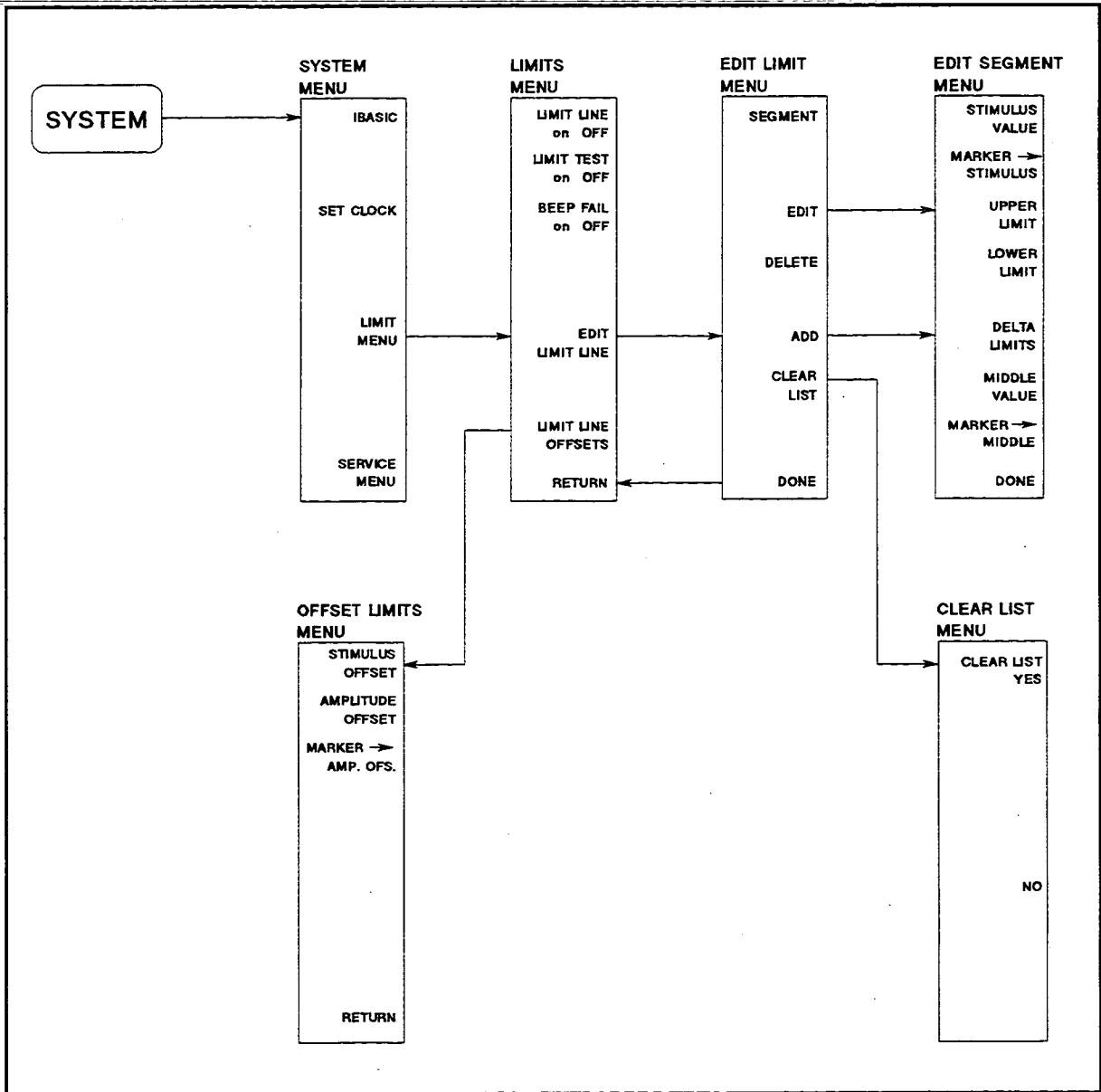

C2009009

Figure E-19. **SYSTEM** Key

E: Softkey Tree

Error Messages

This section lists the error messages that are displayed on the analyzer display or transmitted by the instrument over HP-IB. Each error message is accompanied by an explanation, and suggestions are provided to help in solving the problem. Where applicable, references are given to related sections of the Operation and Maintenance manuals.

When displayed, error messages are usually preceded with the word "CAUTION:". That part of the error message has been omitted here for the sake of brevity. Some messages are for information only, and do not indicate an error condition. Two listings are provided: the first is in alphabetical order, and the second in numerical order.

In addition to error messages, instrument status is indicated by status notations in the left margin of the display. Examples are "*", "msH", and "P↓". Sometimes these appear in conjunction with error messages. A complete listing of status and notations and their meanings is provided in "Front and Rear Panel" in the *Reference Manual*.

ERROR MESSAGES IN ALPHABETICAL ORDER

160 +12V OUT OF SPEC

Severe error. Contact your nearest Hewlett-Packard office.

161 +15V(A) OUT OF SPEC

Severe error. Contact your nearest Hewlett-Packard office.

158 +18V OUT OF SPEC

Severe error. Contact your nearest Hewlett-Packard office.

162 +22V OUT OF SPEC

Severe error. Contact your nearest Hewlett-Packard office.

163 +65V OUT OF SPEC

Severe error. Contact your nearest Hewlett-Packard office.

157 -12.6V OUT OF SPEC

Severe error. Contact your nearest Hewlett-Packard office.

156 -15V OUT OF SPEC

Severe error. Contact your nearest Hewlett-Packard office.

193 1st IF OFFSET OSC TEST FAILED

Severe error. Contact your nearest Hewlett-Packard office.

191 1st LOCAL AMP TEST FAILED

Severe error. Contact your nearest Hewlett-Packard office.

187 1st LOCAL MIXER LOCAL PORT ALC TEST FAILED

Severe error. Contact your nearest Hewlett-Packard office.

150 A1 CPU EXT BUS TEST FAILED

Severe error. Contact your nearest Hewlett-Packard office.

142 A1 ROM TEST FAILED

Severe error. Contact your nearest Hewlett-Packard office.

A40 HEAT SINK TOO HOT

The temperature sensors on the A4 post-regulator assembly have detected an over-temperature condition. Turn the power OFF and let the instrument cool down for approximately 10 minutes. If this message is displayed again, contact your nearest Hewlett-Packard office.

166 Ach +5V(A)/2 OUT OF SPEC

Severe error. Contact your nearest Hewlett-Packard office.

174 Ach A/D LINEARITY POOR

Severe error. Contact your nearest Hewlett-Packard office.

167 Ach A/D REF VOLTAGE OUT OF SPEC

Severe error. Contact your nearest Hewlett-Packard office.

171 Ach RECEIVER FUNCTIONALLY POOR

Severe error. Contact your nearest Hewlett-Packard office.

177 Ach/Rch IF GAIN OUT OF SPEC

Severe error. Contact your nearest Hewlett-Packard office.

6 ADDITIONAL STANDARD NEEDED

Error correction for the selected calibration class cannot be computed until all the necessary standards have been measured.

14 BACKUP DATA LOST

Data check-sum error on the battery backup memory has occurred. The battery is recharged for approximately 10 minutes after power was turned ON.

144 BACKUP RAM TEST FAILED

Severe error. Contact your nearest Hewlett-Packard office.

168 Bch -5.2V(A)/2 OUT OF SPEC

Severe error. Contact your nearest Hewlett-Packard office.

175 Bch A/D LINEARITY POOR

Severe error. Contact your nearest Hewlett-Packard office.

169 Bch A/D REF VOLTAGE OUT OF SPEC

Severe error. Contact your nearest Hewlett-Packard office.

172 Bch RECEIVER FUNCTIONALLY POOR

Severe error. Contact your nearest Hewlett-Packard office.

178 Bch/Rch IF GAIN OUT OF SPEC

Severe error. Contact your nearest Hewlett-Packard office.

-160 Block data error

Block data is improper.

-168 Block data not allowed

Block data is not allowed.

9 CALIBRATION ABORTED

The calibration in progress was terminated due to the change of the active channel or the stimulus parameters.

7 CALIBRATION REQUIRED

No valid calibration coefficients were found when user attempted to turn calibration ON. Refer to "Measurement Calibration" in the *Reference Manual*.

61 CAN'T CHANGE-ANOTHER CONTROLLER ON BUS

The analyzer cannot assume the mode of system controller until the active controller is removed from the bus or relinquishes the bus.

107 CAN'T SAVE GRAPHICS WHEN COPY IN PROGRESS

If user attempts to save graphics when a print or plot is in progress, this error message is displayed.

-148 Character data not allowed

Character data not allowed for this operation.

-144 Character data too long

Character data is too long (maximum length is 12 characters).

137 CONTINUOUS SWITCHING NOT ALLOWED

The current measurement requires the S-parameter test set to switch automatically between forward and reverse measurements (driving test port 1 and, then test port 2). Refer to "Stimulus Function Block" in the *Reference Manual*.

-253 CORRUPT MEDIA

A legal program command could not be executed because of corrupt media; for example, a bad disk or wrong format.

13 CURRENT PARAMETER NOT IN CAL SET

HP-IB only. Correction is not valid for the selected measurement parameter. Refer to "Measurement Calibration" in the *Reference Manual*.

-222 Data out of range

Numerical parameter of HP-IB command is out of the range defined.

-104 Data type error

Improper data type used (for example, string data was expected, but numeric data was received).

10 DC CALIBRATION ABORTED

Pressing the **ABORT DC CAL** softkey causes the analyzer to abort the DC detector linearity calibration in progress.

98 DC OVERLOAD ON INPUT A

97 **DC OVERLOAD ON INPUT B**

99 **DC OVERLOAD ON INPUT R**

The DC voltage at one of the three receiver inputs approach the DC voltage damage level. Refer to "Instrument Specifications" in the *General Information* section for DC damage level information.

-255 **DIRECTORY FULL**

A legal program command could not be executed because the media directory was full.

143 **DRAM TEST FAILED**

Severe error. Contact your nearest Hewlett-Packard office.

145 **EEPROM TEST FAILED**

Severe error. Contact your nearest Hewlett-Packard office.

183 **EEPROM WRITE FAILED**

Severe error. Contact your nearest Hewlett-Packard office.

12 **EXCEEDED 7 STANDARDS PER CLASS**

A maximum of seven standards can be defined for any class. Refer to "Measurement Calibration" in the *Reference Manual*.

5 **EXTERNAL REFERENCE UNLOCKED**

The frequency of the external reference signal input to the connector on the rear panel deviates from $10/N$ MHz, where N is an integer between 1 to 10, and phase lock can no longer be maintained. Refer to "Front and Rear Panel" in the *Reference Manual* for details about the signal requirements.

159 **FAN POWER OUT OF SPEC**

Severe error. Contact your nearest Hewlett-Packard office.

154 **FDC CHIP TEST FAILED**

Severe error. Contact your nearest Hewlett-Packard office.

-257 **FILE NAME ERROR**

A legal program command could not be executed because the file name on the device media was in error; for example, an attempt was made to copy to a duplicate file name.

-256 **FILE NAME NOT FOUND**

A legal program command could not be executed because the file name on the device media was not found; for example, an attempt was made to read or copy a nonexistent file.

192 FN FREQ TEST FAILED

Severe error. Contact your nearest Hewlett-Packard office.

182 FN PRETUNE-DAC/MONITOR FAILURE

Severe error. Contact your nearest Hewlett-Packard office.

62 FORMAT NOT VALID FOR MEASUREMENT

The conversion function except the 1/S mode is not valid for the Smith, Inverse Smith, and SWR formats.

32 FORMAT TYPE IS NOT SMITH

The conjugate matching function is only valid in the Smith chart format.

148 FPC TEST FAILED

Severe error. Contact your nearest Hewlett-Packard office.

-105 GET not allowed

GET is not allowed inside a program message.

151 GSP I/F TEST FAILED

Severe error. Contact your nearest Hewlett-Packard office.

155 HPIB CHIP TEST FAILED

Severe error. Contact your nearest Hewlett-Packard office.

147 INTR TIMER TEST FAILED

Severe error. Contact your nearest Hewlett-Packard office.

-161 Invalid block data

Invalid block data was received (for example, END received before length satisfied).

-141 Invalid character data

Bad character data or unrecognized character data was received.

-121 Invalid character in number

Invalid character in numeric data.

-101 Invalid character

Invalid character was received.

105 INVALID FILE NAME

HP-IB only. The file name for the RECALL, PURGE, or RE-SAVE function must have an “_A”, “_D”, or “_S” extension. Refer to “Saving and Recalling Instrument States and Data” in the *Reference Manual* for more information.

-103 Invalid separator

The message unit separator (for example, “;”, “,”) is improper.

-151 Invalid string data

Invalid string data was received (for example, END received before close quote).

-131 Invalid suffix

Units are unrecognized, or the units are not appropriate.

153 KEY CHIP TEST FAILED

Severe error. Contact your nearest Hewlett-Packard office.

108 LIF-DOS COPY NOT ALLOWED

If the user tries to copy a file between the RAM disk and the flexible disk when the format of the RAM disk is different from the format of the flexible disk, this message is displayed.

57 LIF-DOS copy not allowed

If the user tries to copy a file between the RAM disk and the flexible disk when the format of the RAM disk is different from the format of the flexible disk, this message is displayed.

67 LIST TABLE EMPTY OR INSUFFICIENT TABLE

The frequency list is empty. To implement the list frequency mode, add segments to the list table. Refer to “Stimulus Function Block” in the *Reference Manual*.

81 LOCAL MAX NOT FOUND

The maximum peak whose sharpness is defined by the peak define function cannot be found.

82 LOCAL MIN NOT FOUND

The minimum peak whose sharpness is defined by the peak define function cannot be found.

-250 MASS STORAGE ERROR

A mass storage error occurred. This error message is used when the device cannot detect the more specific errors described for errors -251 through -259.

-254 MEDIA FULL

A legal program command could not be executed because the media was full.

-258 MEDIA PROTECTED

A legal program command could not be executed because the media was protected; for example, the disk was write-protected.

-251 MISSING MASS STORAGE

A legal program command could not be executed because of missing mass storage; for example, attempt to access an external disk drive by using Instrument BASIC.

-252 MISSING MEDIA

A legal program command could not be executed because of a missing media; for example, no disk.

-109 Missing parameter

A command with an improper number of parameters received.

179 MIXER LINEARITY POOR

Severe error. Contact your nearest Hewlett-Packard office.

8 NO CALIBRATION CURRENTLY IN PROGRESS

The **RESUME CAL SEQUENCE** softkey is not valid unless a calibration was already in progress. Start a new calibration. Refer to "Measurement Calibration" in the *Reference Manual*.

112 NO DATA TRACE DISPLAYED

The **SCALE FOR [DATA]** is selected while the data trace is not displayed.

77 NO DATA TRACE

The **MARKER ON [DATA]** is selected while the data trace is not displayed.

106 NO LEGAL FILES ON DISK

There are no files on the disk with extensions, "_A", "_D", or "_S". Refer to "Saving and Recalling Instrument States and Data" in the *Reference Manual* for more information.

83 NO MARKER DELTA - PEAK DEF NOT SET

The **MARKER → PEAK DEF** softkey requires that delta marker mode be turned ON, with at least two markers displayed. Refer to "Using Markers" in the *Reference Manual*.

80 NO MARKER DELTA - RANGE NOT SET

The **SEARCH RNG STORE** softkey requires that delta marker mode be turned ON, with at least two markers displayed. Refer to "Using Markers" in the *Reference Manual*.

79 NO MARKER DELTA - SPAN NOT SET

The **MARKER → SPAN** softkey requires that delta marker mode be turned ON, with at least two markers displayed. Refer to "Using Markers" in the *Reference Manual*.

113 NO MEMORY TRACE DISPLAYED

The **SCALE FOR [MEMORY]** is selected while the memory trace is not displayed.

78 NO MEMORY TRACE

The **MARKER ON [MEMORY]** is selected while the memory trace is not displayed.

118 NO VALID Ach ABS MAG CORRECTION CONSTANTS

Severe error. Contact your nearest Hewlett-Packard office.

119 NO VALID Bch ABS MAG CORRECTION CONSTANTS

Severe error. Contact your nearest Hewlett-Packard office.

123 NO VALID DC FULL SCALE CORRECTION CONSTANTS

Severe error. Contact your nearest Hewlett-Packard office.

126 NO VALID FN PRETUNE CORRECTION CONSTANTS

Severe error. Contact your nearest Hewlett-Packard office.

124 NO VALID HF PWR LIN CORRECTION CONSTANTS

Severe error. Contact your nearest Hewlett-Packard office.

125 NO VALID LF PWR LIN CORRECTION CONSTANTS

Severe error. Contact your nearest Hewlett-Packard office.

30 NO VALID MEMORY TRACE

If a memory trace is to be displayed or otherwise used, a data trace must first be stored to memory. Refer to "Response Function Block" in the *Reference Manual*.

122 NO VALID RATIO A/B CORRECTION CONSTANTS

Severe error. Contact your nearest Hewlett-Packard office.

120 NO VALID RATIO A/R CORRECTION CONSTANTS

Severe error. Contact your nearest Hewlett-Packard office.

121 NO VALID RATIO B/R CORRECTION CONSTANTS

Severe error. Contact your nearest Hewlett-Packard office.

117 NO VALID Rch ABS MAG CORRECTION CONSTANTS

Severe error. Contact your nearest Hewlett-Packard office.

127 NO VALID STEP OSC CORRECTION CONSTANTS

Severe error. Contact your nearest Hewlett-Packard office.

31 NOT AVAILABLE FOR THIS FORMAT

The **D&M SCALE [COUPLED]** softkey is not valid when the format is either LOG MAG & PHASE, or LOG MAG & DELAY.

41 NOT ENOUGH DATA

HP-IB only. The amount of data sent to the analyzer is less than that expected.

11 NOT VALID FOR PRESENT TEST SET

The calibration requested is inconsistent with the test set present. This message occurs in the following situations:

- A full 2-port calibration is requested with a test set other than an S-parameter test set.
- A one-path 2-port calibration is requested with an S-parameter test set (this procedure is typically used with a transmission/reflection test set).

-128 Numeric data not allowed

Numerical data not allowed for this operation.

-123 Numeric overflow

Numerical data value was too large (exponent magnitude >32,000).

95 OVERLOAD ON INPUT A, POWER REDUCED

94 OVERLOAD ON INPUT B, POWER REDUCED

96 OVERLOAD ON INPUT R, POWER REDUCED

When the power level at one of the three receiver inputs exceeds a certain level greater than the maximum input level, the RF output power level is automatically reduced to minimum and the annotation "P↓" appears in the left margin of the display. Refer to "Stimulus Function Block" in the *Reference Manual*.

-108 Parameter not allowed

Too many parameters for the command received.

21 PLOT ABORTED

Pressing the **COPY ABORT** softkey causes the analyzer to abort the plot in progress.

25 PLOTTER NOT READY-PINCH WHEELS UP

If user attempts to plot when the plotter's pinch wheels are up, this message is displayed.

23 PLOTTER: not on, not connected, wrong address

The plotter does not respond to control. Verify power to the plotter, and check the HP-IB connection between the analyzer and the plotter. Ensure that the plotter address recognized by the analyzer matches the HP-IB address set on the plotter itself. Refer to "Instrument State Function Block" in the *Reference Manual* for instruction on setting peripheral addresses.

181 POOR PRETUNE TRACKING

Severe error. Contact your nearest Hewlett-Packard office.

186 POWER LINEARITY TEST FAILED

Severe error. Contact your nearest Hewlett-Packard office.

POWER SHUT DOWN (ANALOG SYSTEM)

Severe error. Contact your nearest Hewlett-Packard office.

4 POWER SHUT DOWN (FDD, FRONT PANEL)

Severe error. Contact your nearest Hewlett-Packard office.

20 PRINT ABORTED

Pressing the **COPY ABORT** softkey causes the analyzer to abort the plot in progress.

24 PRINT/PLOT IN PROGRESS, ABORT WITH COPY ABORT

If a print or plot is in progress and a second print or plot is attempted, this message is displayed and the second attempt is ignored. To abort a print or plot in progress, press **COPY ABORT**.

22 PRINTER: not on, not connected, wrong address

The printer does not respond to control. Verify power to the plotter, and check the HP-IB connection between the analyzer and the printer. Ensure that the printer address recognized by the analyzer matches the HP-IB address set on the printer itself. Refer to "Instrument State Function Block" in the *Reference Manual* for instruction on setting peripheral addresses.

-112 Program mnemonic too long

Program mnemonic is too long (maximum length is 12 characters).

-430 Query DEADLOCKED

Input buffer and output buffer are full; cannot continue.

-400 Query error

Query is improper.

-410 Query INTERRUPTED

Query is followed by DAB or GET before the response was completed.

-440 Query UNTERMINATED after indefinite response

The query which requests arbitrary data response (*IDN? and *OPT? queries) was sent before usual queries in a program message. (for example, **FREQ?;*IDN?** was expected, but ***IDN?;FREQ?** is received.)

-420 Query UNTERMINATED

Addressed to talk, incomplete program message received.

146 RATE TIMER TEST FAILED

Severe error. Contact your nearest Hewlett-Packard office.

164 Rch +5V(D)/2 OUT OF SPEC

Severe error. Contact your nearest Hewlett-Packard office.

173 Rch A/D LINEARITY POOR

Severe error.. Contact your nearest Hewlett-Packard office.

165 Rch A/D REF VOLTAGE OUT OF SPEC

Severe error. Contact your nearest Hewlett-Packard office.

170 Rch RECEIVER FUNCTIONALLY POOR

Severe error. Contact your nearest Hewlett-Packard office.

149 REALTIME CLOCK TEST FAILED

Severe error. Contact your nearest Hewlett-Packard office.

REAR PANEL FAN STOPPED

The analyzer detected that the rear panel fan stopped and automatically shut down the power.

104 RECALL ERROR: INSTR STATE PRESET

A serious error, for example corrupted data, is detected on recalling a file, and this forced the analyzer to be PRESET.

185 RF AMP FLATNESS TEST FAILED

Severe error. Contact your nearest Hewlett-Packard office.

188 RF MIXER LOCAL PORT ALC TEST FAILED

Severe error. Contact your nearest Hewlett-Packard office.

194 RF OSC TEST FAILED

Severe error. Contact your nearest Hewlett-Packard office.

190 RF POWER LEVEL ALC(HF) TEST FAILED

Severe error. Contact your nearest Hewlett-Packard office.

189 RF POWER LEVEL ALC(LF) TEST FAILED

Severe error. Contact your nearest Hewlett-Packard office.

103 SAVE ERROR

A serious error, for example physically damaged disk surface, is detected on saving a file.

176 SOURCE ATTENUATOR OUT OF SPEC

Severe error. Contact your nearest Hewlett-Packard office.

184 STEP OSC TEST FAILED

Severe error. Contact your nearest Hewlett-Packard office.

-150 String data error

String data is improper.

-158 String data not allowed

String data is not allowed.

-138 Suffix not allowed

A suffix is not allowed for this operation.

-102 Syntax error

Unrecognized command or data type was received.

-124 Too many digits

Numerical data length was too long (more than 255 digits received).

-350 Too many errors

Too many errors occurred in HP-IB commands.

68 TOO MANY SEGMENTS OR POINTS

Frequency list mode is limited to 31 segments or 801 points. Refer to "Stimulus Function Block" in the *Reference Manual* for more information.

50 TOO MANY SEGMENTS

The maximum number of segments for the limit line table is 18. Refer to "Instrument State Function Block" in the *Reference Manual*.

-223 Too much data

Either there is too much binary data to send to the analyzer when the data transfer format is FORM 2, FORM 3 or FORM 5, or the amount of data is greater than the number of points.

40 TOO MUCH DATA

The number of data to be sent to the analyzer is greater than that expected.

-113 Undefined header

Undefined header or an unrecognized command was received (operation not allowed).

180 VCO MISADJUSTED, RETRY THIS TEST

Severe error. Contact your nearest Hewlett-Packard office.

152 VRAM TEST FAILED

Severe error. Contact your nearest Hewlett-Packard office.

ERROR MESSAGES IN NUMERICAL ORDER

POWER SHUT DOWN (ANALOG SYSTEM)

Severe error. Contact your nearest Hewlett-Packard office.

A40 HEAT SINK TOO HOT

The temperature sensors on the A4 post-regulator assembly have detected an over-temperature condition. Turn the power OFF and let the instrument cool down for approximately 10 minutes. If this message is displayed again, contact your nearest Hewlett-Packard office.

REAR PANEL FAN STOPPED

The analyzer detected that the rear panel fan stopped and automatically shut down the power.

4 POWER SHUT DOWN (FDD, FRONT PANEL)

Severe error. Contact your nearest Hewlett-Packard office.

5 EXTERNAL REFERENCE UNLOCKED

The frequency of the external reference signal input to the connector on the rear panel deviates from $10/N$ MHz, where N is an integer between 1 to 10, and phase lock can no longer be maintained. Refer to "Front and Rear Panel" in the *Reference Manual* for details about the signal requirements.

6 ADDITIONAL STANDARDS NEEDED

Error correction for the selected calibration class cannot be computed until all the necessary standards have been measured.

7 CALIBRATION REQUIRED

No valid calibration coefficients were found when user attempted to turn calibration ON. Refer to "Measurement Calibration" in the *Reference Manual*.

8 NO CALIBRATION CURRENTLY IN PROGRESS

The **RESUME CAL SEQUENCE** softkey is not valid unless a calibration was already in progress. Start a new calibration. Refer to "Measurement Calibration" in the *Reference Manual*.

9 CALIBRATION ABORTED

The calibration in progress was terminated due to change of the active channel or stimulus parameters.

10 DC CALIBRATION ABORTED

Pressing the **ABORT DC CAL** softkey causes the analyzer to abort the DC detector linearity calibration in progress.

11 NOT VALID FOR PRESENT TEST SET

The calibration requested is inconsistent with the test set present. This message occurs in the following situations:

- A full 2-port calibration is requested with a test set other than an S-parameter test set.
- A one-path 2-port calibration is requested with an S-parameter test set (this procedure is typically used with a transmission/reflection test set).

12 EXCEEDED 7 STANDARDS PER CLASS

A maximum of seven standards can be defined for any class. Refer to "Measurement Calibration" in the *Reference Manual*.

13 CURRENT PARAMETER NOT IN CAL SET

HP-IB only. Correction is not valid for the selected measurement parameter. Refer to "Measurement Calibration" in the *Reference Manual*.

14 BACKUP DATA LOST

Data check-sum error on the battery backup memory has occurred. The battery is recharged for approximately 10 minutes after power was turned ON.

20 PRINT ABORTED

Pressing the **COPY ABORT** softkey causes the analyzer to abort the plot in progress.

21 PLOT ABORTED

Pressing the **COPY ABORT** softkey causes the analyzer to abort the plot in progress.

22 PRINTER: not on, not connect, wrong address

The printer does not respond to control. Verify power to the plotter, and check the HP-IB connection between the analyzer and the printer. Ensure that the printer address recognized by the analyzer matches the HP-IB address set on the printer itself. Refer to "Instrument State Function Block" in the *Reference Manual* for instruction on setting peripheral addresses.

23 PLOTTER: not on, not connect, wrong address

The plotter does not respond to control. Verify power to the plotter, and check the HP-IB connection between the analyzer and the plotter. Ensure that the plotter address recognized by the analyzer matches the HP-IB address set on the plotter itself. Refer to "Instrument State Function Block" in the *Reference Manual* for instruction on setting peripheral addresses.

24 PRINT/PLOT IN PROGRESS, ABORT WITH COPY ABORT

If a print or plot is in progress and a second print or plot is attempted, this message is displayed and the second attempt is ignored. To abort a print or plot in progress, press **COPY ABORT**.

25 PLOTTER NOT READY-PINCH WHEELS UP

If user attempts to plot when the plotter's pinch wheels are up, this message is displayed.

30 NO VALID MEMORY TRACE

If a memory trace is to be displayed or otherwise used, a data trace must first be stored to memory. Refer to "Response Function Block" in the *Reference Manual*.

31 NOT AVAILABLE FOR THIS FORMAT

The **D&M SCALE [COUPLED]** softkey is not valid when the format is either LOG MAG & PHASE, or LOG MAG & DELAY.

32 FORMAT TYPE IS NOT SMITH

The conjugate matching function is only valid in the Smith chart format.

40 TOO MUCH DATA

The amount of data to be sent to the analyzer is greater than that expected.

41 NOT ENOUGH DATA

HP-IB only. The amount of data sent to the analyzer is less than that expected.

50 TOO MANY SEGMENTS

The maximum number of segments for the limit line table is 18. Refer to "Instrument State Function Block" in the *Reference Manual*.

57 LIF-DOS copy not allowed

If the user tries to copy a file between the RAM disk and the flexible disk when the format of the RAM disk is different from the format of the flexible disk, this message is displayed.

61 CAN'T CHANGE- ANOTHER CONTROLLER ON BUS

The analyzer cannot assume the mode of system controller until the active controller is removed from the bus or relinquishes the bus.

62 FORMAT NOT VALID FOR MEASUREMENT

The conversion function except the 1/S mode is not valid for the Smith, Inverse Smith, and SWR formats.

67 LIST TABLE EMPTY OR INSUFFICIENT TABLE

The frequency list is empty. To implement the list frequency mode, add segments to the list table. Refer to "Stimulus Function Block" in the *Reference Manual*.

68 TOO MANY SEGMENTS OR POINTS

Frequency list mode is limited to 31 segments or 801 points. Refer to "Stimulus Function Block" in the *Reference Manual* for more information.

77 NO DATA TRACE

The **MARKER ON [DATA]** is selected while the data trace is not displayed.

78 NO MEMORY TRACE

The **MARKER ON [MEMORY]** is selected while the memory trace is not displayed.

79 NO MARKER DELTA - SPAN NOT SET

The **MARKER → SPAN** softkey requires that delta marker mode be turned ON, with at least two markers displayed. Refer to "Using Markers" in the *Reference Manual*.

80 NO MARKER DELTA - RANGE NOT SET

The **SEARCH RNG STORE** softkey requires that delta marker mode be turned ON, with at least two markers displayed. Refer to "Using Markers" in the *Reference Manual*.

81 LOCAL MAX NOT FOUND

The maximum peak whose sharpness is defined by the peak define function cannot be found.

82 LOCAL MIN NOT FOUND

The minimum peak whose sharpness is defined by the peak define function cannot be found.

83 NO MARKER DELTA - PEAK DEF NOT SET

The **MARKER → PEAK DEF** softkey requires that delta marker mode be turned ON, with at least two markers displayed. Refer to "Using Markers" in the *Reference Manual*.

94 OVERLOAD ON INPUT B, POWER REDUCED

95 OVERLOAD ON INPUT A, POWER REDUCED

96 OVERLOAD ON INPUT R, POWER REDUCED

When the power level at one of the three receiver inputs exceeds a certain level greater than the maximum input level, the RF output power level is automatically reduced to minimum and the annotation "P↓" appears in the left margin of the display. Refer to "Stimulus Function Block" in the *Reference Manual*.

97 DC OVERLOAD ON INPUT B

98 DC OVERLOAD ON INPUT A

99 DC OVERLOAD ON INPUT R

The DC voltage at one of the three receiver inputs approach the DC voltage damage level. Refer to "Instrument Specifications" in the *General Information* section for DC damage level information.

103 SAVE ERROR

A serious error, for example physically damaged disk surface, is detected on saving a file.

104 RECALL ERROR: INSTR STATE PRESET

A serious error, for example corrupted data, is detected on recalling a file, and this forced the analyzer to be PRESET.

105 **INVALID FILE NAME**

HP-IB only. The file name for the RECALL, PURGE, or RE-SAVE function must have an “_A”, “_D”, or “_S” extension. Refer to “Saving and Recalling Instrument States and Data” in the *Reference Manual* for more information.

106 **NO LEGAL FILES ON DISK**

There are no files on the disk with extensions, “_A”, “_D”, or “_S”. Refer to “Saving and Recalling Instrument States and Data” in the *Reference Manual* for more information.

107 **CAN'T SAVE GRAPHICS WHEN COPY IN PROGRESS**

If user attempts to save graphics when a print or plot is in progress, this error message is displayed.

108 **LIF-DOS COPY NOT ALLOWED**

If the user tries to copy a file between the RAM disk and the flexible disk when the format of the RAM disk is different from the format of the flexible disk, this message is displayed.

112 **NO DATA TRACE DISPLAYED**

The **SCALE FOR [DATA]** is selected while the data trace is not displayed.

113 **NO MEMORY TRACE DISPLAYED**

The **SCALE FOR [MEMORY]** is selected while the memory trace is not displayed.

117 **NO VALID Rch ABS MAG CORRECTION CONSTANTS**

Severe error. Contact your nearest Hewlett-Packard office.

118 **NO VALID Ach ABS MAG CORRECTION CONSTANTS**

Severe error. Contact your nearest Hewlett-Packard office.

119 **NO VALID Bch ABS MAG CORRECTION CONSTANTS**

Severe error. Contact your nearest Hewlett-Packard office.

120 **NO VALID RATIO A/R CORRECTION CONSTANTS**

Severe error. Contact your nearest Hewlett-Packard office.

121 **NO VALID RATIO B/R CORRECTION CONSTANTS**

Severe error. Contact your nearest Hewlett-Packard office.

122 **NO VALID RATIO A/B CORRECTION CONSTANTS**

Severe error. Contact your nearest Hewlett-Packard office.

123 NO VALID DC FULL SCALE CORRECTION CONSTANTS

Severe error. Contact your nearest Hewlett-Packard office.

124 NO VALID HF PWR LIN CORRECTION CONSTANTS

Severe error. Contact your nearest Hewlett-Packard office.

125 NO VALID LF PWR LIN CORRECTION CONSTANTS

Severe error. Contact your nearest Hewlett-Packard office.

126 NO VALID FN PRETUNE CORRECTION CONSTANTS

Severe error. Contact your nearest Hewlett-Packard office.

127 NO VALID STEP OSC CORRECTION CONSTANTS

Severe error. Contact your nearest Hewlett-Packard office.

137 CONTINUOUS SWITCHING NOT ALLOWED

The current measurement requires the S-parameter test set to switch automatically between forward and reverse measurements (driving test port 1 and, then test port 2). Refer to "Stimulus Function Block" in the *Reference Manual*.

142 A1 ROM TEST FAILED

Severe error. Contact your nearest Hewlett-Packard office.

143 DRAM TEST FAILED

Severe error. Contact your nearest Hewlett-Packard office.

144 BACKUP RAM TEST FAILED

Severe error. Contact your nearest Hewlett-Packard office.

145 EEPROM TEST FAILED

Severe error. Contact your nearest Hewlett-Packard office.

146 RATE TIMER TEST FAILED

Severe error. Contact your nearest Hewlett-Packard office.

147 INTR TIMER TEST FAILED

Severe error. Contact your nearest Hewlett-Packard office.

148 FPC TEST FAILED

Severe error. Contact your nearest Hewlett-Packard office.

149 **REALTIME CLOCK TEST FAILED**

Severe error. Contact your nearest Hewlett-Packard office.

150 **A1 CPU EXT BUS TEST FAILED**

Severe error. Contact your nearest Hewlett-Packard office.

151 **GSP I/F TEST FAILED**

Severe error. Contact your nearest Hewlett-Packard office.

152 **VRAM TEST FAILED**

Severe error. Contact your nearest Hewlett-Packard office.

153 **KEY CHIP TEST FAILED**

Severe error. Contact your nearest Hewlett-Packard office.

154 **FDC CHIP TEST FAILED**

Severe error. Contact your nearest Hewlett-Packard office.

155 **HPIB CHIP TEST FAILED**

Severe error. Contact your nearest Hewlett-Packard office.

156 **-15V OUT OF SPEC**

Severe error. Contact your nearest Hewlett-Packard office.

157 **-12.6V OUT OF SPEC**

Severe error. Contact your nearest Hewlett-Packard office.

158 **+18V OUT OF SPEC**

Severe error. Contact your nearest Hewlett-Packard office.

159 **FAN POWER OUT OF SPEC**

Severe error. Contact your nearest Hewlett-Packard office.

160 **+12V OUT OF SPEC**

Severe error. Contact your nearest Hewlett-Packard office.

161 **+15V(A) OUT OF SPEC**

Severe error. Contact your nearest Hewlett-Packard office.

162 **+22V OUT OF SPEC**

Severe error. Contact your nearest Hewlett-Packard office.

163 **+65V OUT OF SPEC**

Severe error. Contact your nearest Hewlett-Packard office.

164 **Rch +5V(D)/2 OUT OF SPEC**

Severe error. Contact your nearest Hewlett-Packard office.

165 **Rch A/D REF VOLTAGE OUT OF SPEC**

Severe error. Contact your nearest Hewlett-Packard office.

166 **Ach +5V(A)/2 OUT OF SPEC**

Severe error. Contact your nearest Hewlett-Packard office.

167 **Ach A/D REF VOLTAGE OUT OF SPEC**

Severe error. Contact your nearest Hewlett-Packard office.

168 **Bch -5.2V(A)/2 OUT OF SPEC**

Severe error. Contact your nearest Hewlett-Packard office.

169 **Bch A/D REF VOLTAGE OUT OF SPEC**

Severe error. Contact your nearest Hewlett-Packard office.

170 **Rch RECEIVER FUNCTIONALLY POOR**

Severe error. Contact your nearest Hewlett-Packard office.

171 **Ach RECEIVER FUNCTIONALLY POOR**

Severe error. Contact your nearest Hewlett-Packard office.

172 **Bch RECEIVER FUNCTIONALLY POOR**

Severe error. Contact your nearest Hewlett-Packard office.

173 **Rch A/D LINEARITY POOR**

Severe error. Contact your nearest Hewlett-Packard office.

174 **Ach A/D LINEARITY POOR**

Severe error. Contact your nearest Hewlett-Packard office.

175 Bch A/D LINEARITY POOR

Severe error. Contact your nearest Hewlett-Packard office.

176 SOURCE ATTENUATOR OUT OF SPEC

Severe error. Contact your nearest Hewlett-Packard office.

177 Ach/Rch IF GAIN OUT OF SPEC

Severe error. Contact your nearest Hewlett-Packard office.

178 Bch/Rch IF GAIN OUT OF SPEC

Severe error. Contact your nearest Hewlett-Packard office.

179 MIXER LINEARITY POOR

Severe error. Contact your nearest Hewlett-Packard office.

180 VCO MISADJUSTED, RETRY THIS TEST

Severe error. Contact your nearest Hewlett-Packard office.

181 POOR PRETUNE TRACKING

Severe error. Contact your nearest Hewlett-Packard office.

182 FN PRETUNE-DAC/MONITOR FAILURE

Severe error. Contact your nearest Hewlett-Packard office.

183 EEPROM WRITE FAILED

Severe error. Contact your nearest Hewlett-Packard office.

184 STEP OSC TEST FAILED

Severe error. Contact your nearest Hewlett-Packard office.

185 RF AMP FLATNESS TEST FAILED

Severe error. Contact your nearest Hewlett-Packard office.

186 POWER LINEARITY TEST FAILED

Severe error. Contact your nearest Hewlett-Packard office.

187 1st LOCAL MIXER LOCAL PORT ALC TEST FAILED

Severe error. Contact your nearest Hewlett-Packard office.

188 RF MIXER LOCAL PORT ALC TEST FAILED

Severe error. Contact your nearest Hewlett-Packard office.

189 RF POWER LEVEL ALC(LF) TEST FAILED

Severe error. Contact your nearest Hewlett-Packard office.

190 RF POWER LEVEL ALC(HF) TEST FAILED

Severe error. Contact your nearest Hewlett-Packard office.

191 1st LOCAL AMP TEST FAILED

Severe error. Contact your nearest Hewlett-Packard office.

192 FN FREQ TEST FAILED

Severe error. Contact your nearest Hewlett-Packard office.

193 1st IF OFFSET OSC TEST FAILED

Severe error. Contact your nearest Hewlett-Packard office.

194 RF OSC TEST FAILED

Severe error. Contact your nearest Hewlett-Packard office.

-440 Query UNTERMINATED after indefinite response

The query which requests arbitrary data response (*IDN? and *OPT? queries) was sent before usual queries in a program message. (for example, FREQ?;*IDN? was expected, but *IDN?;FREQ? is received.)

-430 Query DEADLOCKED

Input buffer and output buffer are full; cannot continue.

-420 Query UNTERMINATED

Addressed to talk, incomplete program message received.

-410 Query INTERRUPTED

Query is followed by DAB or GET before the response was completed.

-400 Query error

Query is improper.

-350 Too many errors

Too many errors occurred in HP-IB commands.

-258 MEDIA PROTECTED

A legal program command could not be executed because the media was protected; for example, the disk was write-protected.

-257 FILE NAME ERROR

A legal program command could not be executed because the file name on the device media was in error; for example, an attempt was made to copy to a duplicate file name.

-256 FILE NAME NOT FOUND

A legal program command could not be executed because the file name on the device media was not found; for example, an attempt was made to read or copy a nonexistent file.

-255 DIRECTORY FULL

A legal program command could not be executed because the media directory was full.

-254 MEDIA FULL

A legal program command could not be executed because the media was full.

-253 CORRUPT MEDIA

A legal program command could not be executed because of corrupt media; for example, a bad disk or wrong format.

-252 MISSING MEDIA

A legal program command could not be executed because of a missing media; for example, no disk.

-251 MISSING MASS STORAGE

A legal program command could not be executed because of missing mass storage; for example, attempt to access an external disk drive by using Instrument BASIC.

-250 MASS STORAGE ERROR

A mass storage error occurred. This error message is used when the device cannot detect the more specific errors described for errors -251 through -259.

-223 Too much data

Either there is too much binary data to send to the analyzer when the data transfer format is FORM 2, FORM 3 or FORM 5, or the amount of data is greater than the number of points.

-222 Data out of range

Numerical parameter of HP-IB command is out of the range defined.

-168 Block data not allowed

Block data is not allowed.

-161 Invalid block data

Invalid block data was received (for example, END received before length satisfied).

-160 Block data error

Block data is improper.

-158 String data not allowed

String data is not allowed.

-151 Invalid string data

Invalid string data was received (for example, END received before close quote).

-150 String data error

String data is improper.

-148 Character data not allowed

Character data not allowed for this operation.

-144 Character data too long

Character data is too long (maximum length is 12 characters).

-141 Invalid character data

Bad character data or unrecognized character data was received.

-138 Suffix not allowed

A suffix is not allowed for this operation.

-131 Invalid suffix

Units are unrecognized, or the units are not appropriate.

-128 Numeric data not allowed

Numerical data not allowed for this operation.

-124 Too many digits

Numerical data length was too long (more than 255 digits received).

-123 Numeric overflow

Numerical data value was too large (exponent magnitude > 32,000).

-121 Invalid character in number

Invalid character in numeric data.

-113 Undefined header

Undefined header or an unrecognized command was received (operation not allowed).

-112 Program mnemonic too long

Program mnemonic is too long (maximum length is 12 characters).

-109 Missing parameter

A command with an improper number of parameters was received.

-108 Parameter not allowed

Too many parameters for the command received.

-105 GET not allowed

GET is not allowed inside a program message.

-104 Data type error

Improper data type used (for example, string data was expected, but numeric data was received).

-103 Invalid separator

The message unit separator (for example, “;”, “,”) is improper.

-102 Syntax error

Unrecognized command or data type was received.

-101 Invalid character

Invalid character was received.

Index

Special characters

*, 2-8

1

1/S, 6-8

A

A, 6-6

A/B, 6-6

AB, 6-6

ABODCALI, 7-17

ABORT DC CAL, 7-17

ACTIVATE MARKER, 8-4

Active channel, 2-6, 3-1

Active channel key, 2-4, 3-1

Active Entry Area, 2-8

Active marker, 8-4, 8-5

ADD, 5-14, 9-18

ADDRCONT, 9-6

ADDRESS: 8751, 9-6

Addressable, 9-4, 12-4

ADDRESSABLE ONLY, 9-4

ADDRESS: CONTROLLER, 9-6

ADDRESS: PLOTTER, 9-6

ADDRESS: PRINTER, 9-6

ADDRPLOT, 9-6

ADDRPRIN, 9-6

ADJUST DISPLAY, 6-27

Adjust display menu, 6-34

ALC (automatic leveling control), 1-2

ALL, 11-15

ALL BASIC, 6-28

ALL INSTRUMENT, 6-28

ALL MKR OFF, 8-4

AMPLITUDE OFFSET, 9-21

Aperture, 6-18

A/R, 6-6

AR, 6-6

ASCE, 11-18

ASCII DATA [], 11-18

*, 5-10

ATTEN, 6-2, 6-45

Attenuator menu, 6-45

ATTENUATOR PORT 1, 5-8

ATTENUATOR PORT 2, 5-8

ATTIAODB, 6-45

ATTIA20DB, 6-45

ATTIBODB, 6-45

ATTIB20DB, 6-45

ATTIRODB, 6-45

ATTIR20DB, 6-45

ATTP1, 5-8

ATTP2, 5-8

AUTO, 6-21

AUTOREC, 11-5

Auto recall, 11-5

AUTO SCALE, 6-21

Auto sweep time, 5-9

Averaging, 1-6, 6-40

Averaging factor, 6-40, 6-43

AVERAGING FACTOR, 6-42

AVERAGING on OFF, 6-43

AVERAGING RESTART, 6-42, 6-43

AVERFACT, 6-42

AVEROFF, 6-43

AVERON, 6-43

AVERREST, 6-42

Avg, 2-8, 6-43

AVG, 6-2, 6-19, 6-40

B

B, 6-6

BACI, 6-34

BACKGROUND INTENSITY, 6-34

BACK SPACE, 4-2

BACK SPACE, 6-30, 11-16

BASIC STATUS, 6-28

Battery backup, A-1

Bdc, 6-5

BDC, 6-5

Bdc/R, 6-5

BDCR, 6-5

BEEPDONEOFF, 6-27

BEEPDONEON, 6-27

BEEP DONE ON off, 6-27
BEEPFALLOFF, 9-17
BEEPFALON, 9-17
BEEP FAIL on OFF, 9-17
BEEPWARNOFF, 6-27
BEEPWARNON, 6-27
BEEP WARN on OFF, 6-27
↓, 4-2
↑, 4-2
BLUE connector, 2-10
B/R, 6-6
BR, 6-6
BRIGHTNESS, 6-38, 6-39
Built-in Flexible Disk Drive, 2-5

C

C!, 2-8
C?, 2-8
C2, 2-8
C2!, 2-8
C2?, 2-8
CAL, 7-8
CALARY on OFF, 11-19
CALCASSI, 10-12
CALCULATE PARAMETERS, 6-32, 6-33
CALIBRATE MENU, 7-12
CALIBRATE: NONE, 7-18
Calibration, 7-1, 7-17
Calibration coefficients arrays, 11-3
Calibration kit, 7-36
Calibration standard, 1-2
CALIFUL2, 7-19
CALIONE2, 7-19
CALIRAI, 7-18
CALIRESP, 7-18
CALIS111, 7-18
CALIS221, 7-19
CALK7MM, 7-13
Cal kit, 7-36
CAL KIT, 7-12, 7-37
CAL KIT: 7mm, 7-13
CAL KIT DEFINITION, 10-12
CALKN50, 7-13
CALKN75, 7-13
CALKUSED, 7-13
CALN, 7-18
CALP, 6-32
CALS, 10-13
CBRI, 6-38
CENT, 5-3, 5-17
CENTER, 5-17
CH 1, 3-1

CH1 DATA, 6-35
CH1 MEM LIMIT LN, 6-35
CH 2, 3-1
CH2 DATA, 6-35
CH2 MEM LIMIT LN, 6-35
CHAD, 11-21
CHAN1, 3-1
CHAN2, 3-1
CHANGE DIRECTORY, 11-21
Channel coupling, 7-9
Class assignment, A-9
CLASS ASSIGNMENT, 10-12
CLEAR LIST, 5-14
Clear list menu, 5-18, 9-20
CLEAR LIST YES, 5-18, 9-20
CLEAR MARKER, 8-4
Clear marker menu, 8-6
CLEAR POWER TRIP, 5-8
CLEL, 5-14, 5-18
CLEM1, 8-6
CLEM2, 8-6
CLEM3, 8-6
CLEM4, 8-6
CLEM5, 8-6
CLEM6, 8-6
CLEM7, 8-6
CLEM8, 8-6
CLEPTRIP, 5-8
Clock menu, 9-8
Cnj, 2-8
CNJ P DISP on OFF, 6-26
COLOCH1D, 6-35
COLOCH1M, 6-35
COLOCH2D, 6-35
COLOCH2M, 6-35
COLOGRAT, 6-35
COLOIBT, 6-36
COLOPEN, 6-37
COLOR, 6-38, 6-39, 10-5
COLOR, 6-38
Color adjust menu, 6-38
COLOTEXT, 6-36
COLOWARN, 6-35
CONFIG PLOT, 10-4
CONJ MATCH on OFF, 6-32
Conjugate matching, 1-7, 6-31
CONJUGATE MATCHING, 6-26
Conjugate matching circuit parameters, 2-8
CONMOFF, 6-32
CONMON, 6-32
CONPCP, 6-32

CONPCS, 6-32
 CONPDISPOFF, 6-26
 CONPDISPON, 6-26
 CONPLP, 6-32
 CONPLS, 6-32
 CONT, 5-10
 CONTINUOUS, 5-10, 8-10
 Controller, 12-2
 CONV, 6-5
 CONV1DS, 6-8
 CONVERSION, 6-5, 6-6
 Conversion menu, 6-7
 CONVOFF, 6-8
 CONVYREF, 6-8
 CONVYTRA, 6-8
 CONVZREF, 6-8
 CONVZTRA, 6-8
 COPA, 10-4, 10-15
 COPTOFF, 10-15
 COPTON, 10-15
 COPY, 9-8, 10-2
 COPY ABORT, 10-4, 10-15
 Copy cal kit menu, 10-12
 COPY FILE, 11-21
 Copy limit test menu, 10-14
 Copy list sweep menu, 10-13
 Copy menu, 10-4
 Copy more menu, 10-10
 Copy standard number menu, 10-13
 COPY TIME, 9-8
 COPY TIME on OFF, 10-15, D-35
 Cor, 2-8
 Correction menu, 7-11
 CORRECTION on OFF, 7-11
 CORROFF, 7-11
 CORRON, 7-11
 COUCOFF, 5-6
 COUCON, 5-6
 COUPLED CH on OFF, 5-6
 Cp, 6-32
 Cp-Cs, 6-33
 Cp-Ls, 6-33
 CREATE DIRECTORY, 11-21
 CRED, 11-21
 Crosstalk, 7-2, 7-5, 7-18
 CRT display, 2-4, 2-6
 Cs, 6-32
 Cs-Cp, 6-33
 Cs-Lp, 6-33
 CTR & SPAN, 10-14

CW FREQ, 5-7
 CWFREQ, 5-7

D

DATA and MEMORY, 6-29
 Data arrays, 11-3
 DATA ARY on OFF, 11-19
 DATA & GRATCL, 10-7
 DATA-MEM, 6-29
 DATA/MEM, 6-29
 DATA ONLY, 10-8
 DATA ONLY (ASCII), 11-17
 Data point, 1-4
 DATA → MEM, 6-29
 DATE MM/DD/YY, 9-8
 DATE MODE: MonDayYear, 9-9
 DATI, 6-29
 DAY, 9-10
 DayMonYear, 9-9
 DAYMYEAR, 9-9
 DCCOROFF, 7-16
 DCCORON, 7-16
 DC correction menu, 7-16
 DC CORR on OFF, 7-16
 DC DETECT. LIN CORR, 7-15
 DC voltage measurement, 6-4
 Default, A-1
 DEFAULT COLORS, 6-34, 6-39
 DEFAULT SETUP, 10-6
 DEFC, 6-34
 DEFINE EXTENSION, 11-17
 DEFINE PLOT, 10-5
 Define plot menu, 10-7
 DEFINE SAVE DATA, 11-15, 11-17
 Define save data menu, 11-19
 DEFINE STANDARD, 7-38
 Define standard menu, 7-39
 Define standard number menu, 7-38
 DEFINE TRACE, 6-26
 DEFS, 7-38
 De1, 2-8
 DELA, 6-12
 DELAY, 6-12
 DELETE, 5-14, 9-18
 DELO, 8-7
 DELR1, 8-8
 DELR2, 8-8
 DELR3, 8-8

DELR4, 8-8
 DELR5, 8-8
 DELR6, 8-8
 DELR7, 8-8
 DELR8, 8-8
 DELRFIXM, 8-7
 DELTA LIMITS, 9-19
 Delta marker menu, 8-8
 Delta marker mode, 8-2, 8-7
 DFLT, 10-6
 Directivity, 7-2, 7-18, 7-19, 7-52
 DISAALLB, 6-28
 DISAALLI, 6-28
 DISABASI, 6-28
 DISAHIHB, 6-28
 DISFDOS, 11-21
 DISFLIF, 11-21
 Disk capacity, 11-4
 Disk format, 11-4
 Disk menu, 11-21
 DISL1, 10-13
 DISL2, 10-13
 DISLLIST, 10-14
 DISMCTSP, 10-14
 DISMMD, 10-14
 DISMNUM, 10-14
 DISMSTEP, 10-14
 DISMSTSP, 10-14
 DISMUL, 10-14
 DISPDATA, 6-29
 DISPDATM, 6-29
 DISPDDM, 6-29
 DISPDM, 6-29
 DISPLAY, 6-1, 6-24
 DISPLAY ALLOCATION, 6-26
 Display allocation menu, 6-27
 DISPLAY: DATA, 6-29
 DISPLAY LIST, 10-14
 DISPLAY: LIST1, 10-13
 Display menu, 6-25
 DISPMEMO, 6-29
 DISP MODE: ST & SP, 10-14
 DISP MODE: UPR & LWR, 10-14
 D&M SCALE, 6-21
 DUACOFF, 6-25
 DUACON, 6-25
 DUAL CHAN on OFF, 6-25
 DUT, 1-1

E

EDIT, 5-14, 9-18
 EDIT, 5-14
 EDITDONE, 5-14
 EDIT LIMIT LINE, 9-17
 Edit limits menu, 9-17
 EDITLIML, 9-17
 EDITLIS1, 5-14
 EDITLIS2, 5-14
 EDIT LIST, 5-12
 EDITLIST, 5-12
 Edit list menu, 5-13
 Edit segment menu, 5-15, 9-18
 ELEC DELAY MENU, 6-21
 Electrical delay, 1-7, 6-21, 7-16
 ELECTRICAL DELAY, 6-22, 7-14
 ELED, 6-22
 Entry, 2-5, 3-1
 ENTRY OFF, 4-2
 ERASE TITLE, 6-30, 11-16
 EXECUTE DC CAL, 7-16
 EXEDCALI, 7-16
 EXPANDED PHASE, 6-15
 Expanded Phase format, 6-15
 EXPP, 6-15
 Ext, 2-8
 EXTENSION, 7-15
 EXTENSIONS on OFF, 7-15
 EXT PROG RUN/CONT connector, 2-10
 EXT REF INPUT connector, 2-10
 EXTTOFF, 5-10
 EXTTON, 5-10
 EXTTPOIN, 5-11
 EXT TRIGGER connector, 2-10
 EXT. TRIG ON POINT, 5-11
 EXT. TRIG ON SWEEP, 5-10

F

Factory setting, A-1
 Fan, 2-10
 FILC, 11-21
 File name, 11-4
 File size, 11-5
 FILE UTILITIES, 11-15
 Fixed marker menu, 8-9
 FIXED MKR AUX VALUE, 8-10
 FIXED MKR STIMULUS, 8-9
 FIXED MKR VALUE, 8-10
 Format, 2-7, 6-10
 FORMAT, 6-1, 6-10

FORMAT [], 11-21

Format more menu, 6-14

Forward transmission coefficient, 6-5

FREQ, 6-27**FREQUENCY BLANK**, 6-27

Frequency list mode, 5-12

Frequency response, 7-2, 7-6, 7-18, 7-19, 7-52,
7-53, 7-56

Front panel, 2-4

FULL 2-PORT, 7-19

Full 2-Port Calibration, 7-28

FULL PAGE, 10-6

Full two-port calibration, 7-6

FULP, 10-6**FWD MATCH**, 7-45**FWD TRANS.**, 7-45**G**

G, 4-2

(G/n), 4-2**GRAE**, 11-18**GRAPHICS**, 11-17**GRAPHICS** [], 11-18**GRATICULE**, 6-35**GREEN** connector, 2-10**GRODAPER**, 6-43

Group delay, 6-17

GROUP DELAY APERTURE, 6-19, 6-43**H****HALF INSTR HALF BASIC**, 6-28

Hard copy, 10-1

Hewlett-Packard Interface Bus, 9-3, 12-1

Hld, 2-8, 5-10**HOLD**, 5-10**HOLD**, 5-10**HOUR**, 9-9

HP 11667A, 1-2

HP 11850C,D, 1-2

HP 87511A, B, 7-59

HP 87511A,B, 1-2, 2-9

HP 87512A, B, 7-59

HP 87512A,B, 1-2, 2-9, 6-4

HP-HIL connector, 2-5

HP-IB, 2-2, 9-3, 12-1

HP-IB address, 12-4

HP-IB connector, 2-9

I**IBASIC**, 6-36, 9-7

IF bandwidth, 1-6, 6-41, 6-43, 6-44

IF BW, 5-16, 6-43**IFBW**, 5-16, 6-43**IF BW AUTO**, 6-44**IFBWAUTO**, 6-44

IF (Intermediate frequency), 1-2

IMAG, 6-14**IMAGINARY**, 6-14

Imaginary format, 6-14

INID, 11-21

Initialize, A-1

INITIALIZE, 11-21

Initialize menu, 11-24

INITIALIZE YES, 11-24**INPUT-A:**, 6-45**INPUT-B:**, 6-45

Input port menu, 6-6

INPUT PORTS, 6-5**INPUT-R:**, 6-45

Instrument BASIC, 9-22

Instrument data arrays, 11-3

Instrument state, 2-2

Instrument state data, 11-3

Instrument state function, 2-5, 9-1

Instrument states and internal data arrays, 11-3

INTE, 6-34**INTENSITY**, 6-34

Interpolated error correction, 5-11, 7-9

INT REF OUTPUT connector, 2-10

Inverse smith chart format, 6-15

INVL TYPE: Ls-Lp, 6-33**INVSCHAR**, 6-15**INV SMITH CHART**, 6-15

I/O port connector, 2-9

Isolation, 7-2, 7-5, 7-18, 7-19, 7-56

Isolation calibration, 7-10

Isolation error, 7-58

K

K, 4-2

KEY 15, 7-8

KEY 17, 8-14

KEY 19, 5-5

KEY 24, 4-2

KEY 25, 4-2

KEY 26, 4-2

KEY 27, 4-2

KEY 41, 4-2

KEY 42, 4-2

KEY 43, 4-2

KITD, 7-38
KIT DONE, 7-38
(k/m), 4-2

L

LABEL CLASS, 7-38
Label class menu, 7-46
LABEL KIT, 7-38, 7-47
Label kit menu, 7-47
Label standard menu, 7-43
LABK, 7-38
LEFL, 10-6
LEFT LOWER, 10-6
LEFT UPPER, 10-6
LEFU, 10-6
LIF (logical inter change format), 11-4
LIMCLEL, 9-20
LIMD, 9-19
LIMIAMPD, 9-21
LIMILINEOFF, 9-16
LIMILINEON, 9-16
LIMIMAOF, 9-21
LIMISTIO, 9-21
LIMITESTOFF, 9-16
LIMITESTON, 9-16
Limit line, 9-11
LIMIT LINE OFFSETS, 9-17
LIMIT LINE on OFF, 9-16
LIMIT MENU, 9-7
Limits menu, 9-16
Limit test, 9-11
LIMIT TEST on OFF, 9-16
LIMIT TEST TABLE, 10-12
LIML, 9-19
LIMM, 9-20
LIMS, 9-19
LIMSADD, 9-18
LIMSDEL, 9-18
LIMSDON, 9-20
LIMSEDI, 9-18
LIMU, 9-19
Linear frequency sweep mode, 5-11
LINE switch, 2-4
LINE TYPE DATA, 10-8
LINE TYPE MEMORY, 10-8
LIN FREQ, 5-11
LINFREQ, 5-11
LINM, 6-13
LIN MAG, 6-13
LINTDATA, 10-8
LINTMEMO, 10-8

LISDFBASE, 5-12
LISDOBASE, 5-12
LISFREQ, 5-12
LISSLIS1, 5-13
LISSLIS2, 5-13
LIST2, 10-13
LIST DISP: FREQ BASE, 5-12
LIST DONE, 5-14
Listener, 12-2
LIST FREQ [], 5-12
List sweep menu, 5-13
LIST SWEEP TABLE, 5-12, 10-12
LIST VALUES, 10-10
LISV, 10-10
Load match, 7-2, 7-4, 7-19, 7-56
Load match error, 7-57
(LOCAL), 9-3
LOCAL MAX, 8-19, 8-20
LOCAL MIN, 8-19, 8-20
Local mode, 9-3
Logarithmic frequency sweep mode, 5-11
LOG FREQ, 5-11
LOGFREQ, 5-11
LOGM, 6-11
LOG MAG, 6-11
LOG MAG & DELAY, 6-16
Log magnitude and delay format, 6-16
Log magnitude and Phase Format, 6-16
LOG MAG & PHASE, 6-16
LOGMD, 6-16
LOGMP, 6-16
LOWER GRATICULE, 10-8
LOWER LIMIT, 9-19
Lp, 6-32
Lp-Cs, 6-33
Ls-Cp, 6-33
L TYPE: Lp-Ls, 6-33

M

M, 4-2
MA, 4-2
man, 5-11
MANTRIG, 5-11
Manual Changes, D-1
Manual sweep time, 5-9
MANUAL TRG ON POINT, 5-11
MARK1, 8-5
MARK2, 8-5
MARK3, 8-5

- MARK4, 8-5
- MARK5, 8-5
- MARK6, 8-5
- MARK7, 8-5
- MARK8, 8-5
- MARKCENT, 8-15
- MARKCONT, 8-10
- MARKCOUP, 8-11
- MARKDELA, 6-22
- MARKDISC, 8-10
- Marker data readout, 2-7
- Marker function menu, 8-15
- Marker list, 8-1
- Marker menu, 8-4
- Marker mode menu, 8-10
- MARKER MODE MENU, 8-5
- MARKER → AMP. OPS., 9-21
- MARKER → CENTER, 8-15
- MARKER → DELAY, 6-22
- MARKER → MIDDLE, 9-20
- MARKER → REFERENCE, 6-21, 8-15
- MARKER → SPAN, 8-15
- MARKER → START, 8-15
- MARKER → STIMULUS, 9-19
- MARKER → STOP, 8-15
- MARKERS: COUPLED, 8-11
- MARKERS: DISCRETE, 8-10
- Marker Search menu, 8-17
- MARKERS ON [DATA], 8-4
- Marker statistics, width value, 2-7
- MARKERS: UNCOUPLED, 6-26
- Marker time mode, 8-1
- MARKFAUV, 8-10
- MARKFSTI, 8-9
- MARKFVAL, 8-10
- MARKLOFF, 8-4
- MARKLON, 8-4
- MARKMIDD, 9-20
- MARKODATA, 8-4
- MARKOFF, 8-4
- MARKOMEMO, 8-4
- MARKPEAD, 8-19
- MARKREF, 6-21, 8-15
- MARKSPAN, 8-15
- MARKSTAR, 5-16, 8-15
- MARKSTIM, 9-19
- MARKSTOP, 5-16, 8-15
- MARKTIMEOFF, 8-11
- MARKTIMEON, 8-11
- MARKUNCO, 8-11
- MARKZERO, 8-4
- MAX, 8-17
- MEAS, 6-1, 6-2
- MEASA, 6-6
- MEASB, 6-6
- MEASTATOFF, 8-16
- MEASTATON, 8-16
- Measured input, 2-6
- MEASURE RESTART, 5-2, 5-6
- MEMORY, 6-29
- Memory arrays, 11-3
- MEMORY ARY on OFF, 11-19
- Memory trace arrays, 11-3
- MENU, 5-5
- Message area, 2-8
- MIDDLE VALUE, 9-20
- MTD & DLT, 10-14
- MIN, 8-17, 9-9
- Minimum sweep time, 5-9
- MKR, 8-1
- MKR FCTN, 8-14
- MKR LIST on off, 8-4
- MKR → START, 5-16
- MKR → STOP, 5-16
- MKR SEARCH, 8-16
- MKR TIME on OFF, 8-11
- MKR ZERO, 8-4
- M/μ, 4-2
- MODI1, 7-13
- MODIFY, 7-13, 7-37
- Modify cal kit menu, 7-37
- MODIFY COLORS, 6-34
- Modify colors menu, 6-35
- Modify colors more menu, 6-36
- MONDYEAR, 9-9
- MONTH, 9-10
- msH, 2-8, 5-2
- N**
- N, 4-2
- N 50Ω, 7-13
- N 75Ω, 7-13
- Network analyzer inputs R, A, and B, 2-5
- NEXP, 10-16
- NEXT PAGE, 10-16
- Non-volatile memory, A-1
- NUMBER of GROUPS, 5-2, 5-10
- NUMBER of POINTS, 5-5, 5-16, 10-14
- NUMG, 5-10

O

OFF, 6-8
OFFSET DELAY, 7-42
 Offset limit menu, 9-21
OFFSET LOSS, 7-42
OFFSET Z0, 7-42
OFSD, 7-42
OFSL, 7-42
OFSZ, 7-42
 Omitting isolation calibration, 7-10
ONE-PATH 2-PORT, 7-19
 One-Path 2-Port Calibration, 7-32
 One-path two-port calibration, 7-6
 One-port calibration, 7-6
 One-Port Error Model, 7-52
OPEP, 10-11
OPERATING PARAMETERS, 10-11
 Option 001, 2-10
 Option 002, 9-22
ORDER BASE, 5-12
 Output power level, 5-5, 5-7

P

PARAMETER:LS, 6-32
PARSOFF, 8-16
PARSON, 8-16
PART SRCH on OFF, 8-16
 Pass/Fail, 2-7
P↓, 2-8, 5-7, 5-8
PEADX, 8-19
PEADY, 8-19
PEAK DEF: ΔX(Y), 8-20
PEAK-PEAK, 8-19, 8-20
PEN, 6-37
 Pen Menu, 6-37
PENNCH1DATA, 10-16
PENNCH1MEM, 10-16
PENNCH2DATA, 10-16
PENNCH2MEM, 10-16
PENNGRAT, 10-16
PENNIBPEN1, 10-17
PENNIBPEN2, 10-17
PENNIBPEN3, 10-17
PENNIBPEN4, 10-17
PENNIBPENS, 10-17
PENNIBPEN6, 10-17
PENNIBTEXT, 10-17
PENNTTEXT, 10-17
 pen number, 10-16
PEN NUM CH1 DATA, 10-16
PEN NUM CH1 MEM, 10-16
PEN NUM CH2 DATA, 10-16
PEN NUM CH2 MEM, 10-16
PEN NUM GRATICULE, 10-16
PEN NUM IB TEXT, 10-17
PEN NUM PEN 1, 10-17
PEN NUM PEN 2, 10-17
PEN NUM PEN 3, 10-17
PEN NUM PEN 4, 10-17
PEN NUM PEN 5, 10-17
PEN NUM PEN 6, 10-17
PEN NUM TEXT, 10-17
PHAO, 6-23
PHAS, 6-11
PHASE, 6-11
PHASE OFFSET, 6-23
PLOALL, 10-7
PLODGRAT, 10-7
PLODONLY, 10-8
PLOFAST, 10-8
PLOSSLOW, 10-8
PLOT, 10-4, 10-15
PLOT, 10-4, 10-15
PLOT: ALL, 10-7
PLOT SPEED, 10-8
POIN, 5-5
 Point, 1-4
POINT, 5-16
POLA, 6-13
POLAR, 6-13
 Polar marker menu, 8-11
POLAR MKR MENU, 8-11
POLMLIN, 8-12
POLMLOG, 8-12
POLMRI, 8-12
POREOFF, 7-15
POREON, 7-15
PORT1, 7-16
PORT2, 7-16
PORTA, 7-16
PORTB, 7-16
PORT EXTENSIONS, 7-14
PORTR, 7-15
POWE, 5-5, 5-7, 5-16
POWER, 5-5, 5-7
 power splitter, 1-2
POWER SWEEP, 5-12
 Power sweep mode, 5-12
 Power trip, 5-8
POWS, 5-12

- PREP, 10-16
 (PRESET), 2-5, A-1
 Preset state, A-1
 PREV FILES, 11-20
 PREV PAGE, 10-16
 PRIC, 10-5
 PRICFIXE, 10-5
 PRICVARI, 10-5
 PRINALL, 10-4, 10-15
 PRINT COLOR [FIXED], 10-5
 PRINT/PLOT SETUP, 10-5
 PRINT/PLOT SETUPS, 10-15
 PRINT: STANDARD, 10-5
 PRINT [STANDARD], 10-4, 10-15
 PRIS, 10-5
 PROBE POWER connector, 2-5
 PURG, 11-21
 PURGE FILE, 11-21
 Purge file menu, 11-22
 Purge Menu, 11-23
 PURGE YES, 11-23
- R**
- RAM disk, 11-1
 RAW ARY on OFF, 11-19
 Raw data arrays, 11-3
 REAL, 6-14
 REAL, 6-14
 Real format, 6-14
 Rear panel, 2-9
 (RECALL), 11-13
 RECALL COLORS, 6-34, 6-39
 Recall file menu, 11-25
 RECC, 6-34
 Recharge time, A-1
 RED connector, 2-10
 Reference level, 2-7
 Reference plane menu, 7-15
 REFERENCE POSITION, 6-21
 REFERENCE VALUE, 6-21
 Reflection coefficient, 6-5, 6-14, 7-52
 Ref1: FWD S11 (A/R), 6-5
 Ref1: REV S22 (B/R), 6-5
 REF OVEN (Option 001) connector, 2-10
 REFP, 6-21
 REFV, 6-21
 Remote mode, 9-3
 RESAVD, 11-15
 RE-SAVE FILE, 11-15
 Re-save file menu, 11-20
- RESC, 7-12
 RESD, 10-16
 RESET COLOR, 6-38
 Response, 2-2
 RESPONSE, 7-18, 7-46
 Response and isolation calibration, 7-6, 7-22, 7-24, 7-46
 Response calibration, 7-6, 7-20, 7-21, 7-46
 Response function, 2-4, 6-1
 RESPONSE & ISOL'N, 7-18, 7-46
 REST, 5-6
 RESTORE DISPLAY, 10-16
 RESUME CAL SEQUENCE, 7-12
 Reverse transmission coefficient, 6-5
 REV MATCH, 7-46
 REV TRANS., 7-45
 RF OUT connector, 2-5
 ρ , 6-14
 RIGHT LOWER, 10-6
 RIGHT UPPER, 10-6
 RIGL, 10-6
 RIGU, 10-6
 RMT, 2-8
 RSCO, 6-38
- S**
- S11, 6-5
 S11 1-PORT, 7-18
 S11 1-port calibration, 7-25, 7-45
 S11B, 7-45
 S11C, 7-45
 S11 one-port calibration, 7-6
 S12, 6-5
 S21, 6-5
 S22, 6-5
 S22 1-PORT, 7-19
 S22 1-port calibration, 7-27, 7-45
 S22 one-port calibration, 7-6
 SADD, 5-14
 SAVCAOFF, 11-19
 SAVCAON, 11-19
 SAVDAL, 11-15
 SAVDAOFF, 11-19
 SAVDAON, 11-19
 SAVDASC, 11-17
 SAVDDAT, 11-15
 SAVDGRA, 11-17
 SAVDSTA, 11-15
 (SAVE), 11-13
 SAVE COLORS, 6-34, 6-39
 SAVE DATA ONLY, 11-15

SAVE FILE, 11-15
SAVE STATE ONLY, 11-15
SAVEUSEK, 7-13
SAVE USER KIT, 7-13, 7-38
SAVMAOFF, 11-19
SAVMAON, 11-19
SAVRAOFF, 11-19
SAVRAON, 11-19
SAVTAOFF, 11-19
SAVTAON, 11-19
SAVTMAOFF, 11-19
SAVTMAON, 11-19
SAVUAOFF, 11-19
SAVUAON, 11-19
SCAC, 6-21
SCAFDATA, 6-21
SCAFMEMO, 6-21
SCAL, 6-21
Scale/Div, 2-7
SCALE/DIV, 6-21
SCALE FOR, 6-21
SCALE: FULL, 10-8
SCALE PLOT, 10-8
Scale plot menu, 10-8
SCALE REF, 6-1, 6-20
Scale reference menu, 6-20
SCAPFULL, 10-8
SCAPGL, 10-8
SCAPGU, 10-8
scattering parameters, 6-3
SCAU, 6-21
Screen menu, 10-15
SDEL, 5-14
SDON, 5-16
SEAL, 8-18
SEALMAX, 8-19
SEALMIN, 8-19
SEAMAX, 8-17
SEAMEAN, 8-19
SEAMIN, 8-17
SEAOFF, 8-17
SEAPPEAK, 8-19
SEAR, 8-18
SEARCH IN, 8-21
SEARCH LEFT, 8-18
SEARCH: MEAN, 8-19
SEARCH: OFF, 8-17
SEARCH OUT, 8-21
SEARCH RANGE, 8-15
Search Range menu, 8-16
SEARCH RIGHT, 8-18

SEARCH RNG STORE, 8-16
SEARSTOR, 8-16
SEATARG, 8-17, 8-18
SEC, 9-9
SEDI, 5-14
Segment, 9-13
SEGMENT, 5-14, 9-18
SEGMENT DONE, 5-16
SEGMENT POWER, 5-16
SEGMENT START, 5-17
SELCLSLP, 6-33
SELEC, 6-32
SELECCPCS, 6-33
SELECCPLS, 6-33
SELECCSCP, 6-33
SELECCSLP, 6-33
SELECLPCS, 6-33
SELECLPLS, 6-33
SELECLSCP, 6-33
Select cal kit menu, 7-12
Select circuit menu, 6-33
SELECT CRT [Ls-Lp], 6-32
SELECT LETTER, 6-30, 11-16
SELECT QUADRANT, 10-5
Serial number plate, 2-9
SERVICE MENU, 9-7
SET ADDRESSES, 9-5
SETCDATE, 9-8
SET CLOCK, 9-7
SETCTIME, 9-8
Set date menu, 9-10
Set time menu, 9-9
SETZ, 7-15
SET ZO, 7-15
SING, 5-10
SINGLE, 5-10
SMIC, 6-12
SMIMB, 8-13
SMIMLIN, 8-12
SMIMLOG, 8-12
SMIMRI, 8-12
SMIMRX, 8-13
Smith chart, 6-12
SMITH CHART, 6-12
Smith marker menu, 8-12
SMITH MKR MENU, 8-11
Smo, 2-8, 6-43
SMOOAPER, 6-43
SMOOIFF, 6-43
SMOOON, 6-43
Smoothing, 1-7, 6-41

- Smoothing aperture, 6-43
 - SMOOTHING APERTURE, 6-43
 - SMOOTHING on OFF, 6-43
 - Softkey, 2-4
 - Softkey label, 2-7
 - Source match, 7-2, 7-3, 7-19, 7-52, 7-53, 7-56
 - SPACE, 6-30, 11-16
 - SPAN, 5-3, 5-17
 - (SPAN), 5-3
 - SPAN, 5-17
 - S-parameter, 6-2, 6-3, 6-4
 - S PARAMETERS, 6-6
 - S-parameter test set, 1-2, 2-9, 5-8, 7-59
 - SPECFWDM, 7-45
 - SPECFWDT, 7-45
 - SPECIFY CLASS, 7-38
 - Specify class menu, 7-44
 - Specify offset menu, 7-42
 - SPECIFY: S11A, 7-45
 - SPECIFY: S22A, 7-45
 - SPECRESI, 7-46
 - SPECRESP, 7-46
 - SPECREVM, 7-46
 - SPECREVT, 7-45
 - SPECS11A, 7-45
 - SPECS11B, 7-45
 - SPECS11C, 7-45
 - SPECS22A, 7-45
 - SPECS22B, 7-45
 - SPECS22C, 7-45
 - SPLDOFF, 6-26
 - SPLDON, 6-26
 - Split display, 6-26
 - SPLIT DISP on OFF, 6-26
 - SPLIT DISP ON off, 6-25
 - Standard class assignment, A-9
 - STANDARD DEFINITION, 10-12
 - Standard device, 7-9, 7-12
 - Standard kit, A-7
 - STAR, 5-3, 5-17
 - (START), 5-3
 - STATISTICS, 8-16
 - STD DONE(DEFINED), 7-41
 - STD NO. n., 7-38, 10-13
 - STD TARBI, 7-41
 - STD TDELA, 7-41
 - STD TLOAD, 7-41
 - STD TOPEN, 7-40
 - STD TSHOR, 7-41
 - STEP SIZE, 5-16, 10-14
 - Stimulus, 1-4, 2-2, 5-5
 - Stimulus function, 2-4, 5-1
 - STIMULUS OFFSET, 9-21
 - Stimulus start value, 2-7
 - Stimulus stop value, 2-7
 - STIMULUS VALUE, 9-19
 - STODDISK, 11-15
 - STODMEMO, 11-15
 - STOP, 5-17
 - (STOP), 5-3
 - STOP, 5-17
 - Storage devices, 11-1
 - STOR DEV [], 11-15
 - STPSIZ, 5-16
 - Svc, 2-8
 - SVCO, 6-34
 - Sweep, 1-4, 5-11
 - SWEEP by:, 5-13
 - SWEEP TIME, 5-8
 - SWEEP TIME [], 5-5
 - SWEEP TIME AUTO, 5-9
 - Sweep time menu, 5-8
 - SWEEP TYPE MENU, 5-7
 - SWET, 5-8
 - SWETAUTO, 5-9
 - SWR, 6-14
 - SWR, 6-14
 - (SYSTEM), 9-7
 - System controller, 9-4, 12-3, 12-4
 - SYSTEM CONTROLLER, 9-4
- ## T
- Talker, 12-2
 - TARGET, 8-17, 8-18
 - Target menu, 8-18
 - TERI, 7-41
 - TERMINAL IMPEDANCE, 7-41
 - Test set, 1-2
 - TEST SET INTERCONNECT, 2-9
 - TEXT, 6-36
 - TIME HH:MM:SS, 9-8
 - TINT, 6-38
 - TINT, 6-38
 - TITL, 6-26
 - Title, 2-8, 6-29, 11-16
 - TITLE, 6-26
 - T. MEM ARY on OFF, 11-19
 - Trace arrays, 11-3
 - TRACE ARY on OFF, 11-19
 - Trace math menu, 6-28
 - Trace math operation, 1-7

Tracking, 7-2, 7-6, 7-19, 7-52, 7-53, 7-56
TRACKING on OFF, 8-17
TRACKOFF, 8-17
TRACKON, 8-17
Trans: FWD S21 (B/R), 6-5
Transmission coefficient, 7-57
Transmission/reflection test kit, 1-2, 2-9, 7-59
Transmission/reflection test set, 6-4
Trans: REV S12 (A/R), 6-5
Trigger menu, 5-9
TRIGGER MENU, 5-5
TRIGGER: TRIG OFF, 5-10
Two-Port Error Model, 7-56

U

U, 4-2
Δ MODE MENU, 8-4
Δ MODE OFF, 8-7
Δ REF MARKER, 8-7
ΔREF=Δ FIXED MKR, 8-7
UNCOUPLED, 8-11
UNIFORM ARY on OFF, 11-19
Unformat arrays, 11-3
↑, 5-9
UPPER GRATICULE, 10-8
UPPER LIMIT, 9-19
User-defined cal kit, 7-36

USER KIT, 7-13

V

VELOCITY FACTOR, 7-15
VELOFACT, 7-15

W

WARNING, 6-35
WIDSIN, 8-21
WIDSON, 8-21
Width menu, 8-21
WIDTHS on OFF, 8-21
WIDTH VALUE, 8-21
WIDTOFF, 8-21
WIDTON, 8-21
WIDV, 8-21

X

x1, 4-2

Y

YEAR, 9-10
Y: Refl, 6-8
Y: Trans, 6-8

Z

Z: Refl, 6-8
Z: Trans, 6-8

Reorder No. or
Manual Part No.
08751-90000

Copyright © 1990,1992
Hewlett-Packard
Printed in Japan

Manufacturing
Part No.
08751-90000



08751-90000