



**Advanced Test Equipment Rentals**  
**www.atecorp.com 800-404-ATEC (2832)**

## **Technical Specifications**

**Agilent Technologies**  
**PNA Series Network Analyzers**  
**E8362B/C, E8363B/C, and E8364B/C**



**Manufacturing Part Number: E8364-90031**

**Printed in USA**

**Print Date: October 3, 2008**

**Supersedes: September 8, 2008**

© Agilent Technologies, Inc. 2004, 2006 - 2008 All rights reserved.

---

## Documentation Warranty

THE MATERIAL CONTAINED IN THIS DOCUMENT IS PROVIDED "AS IS," AND IS SUBJECT TO BEING CHANGED, WITHOUT NOTICE, IN FUTURE EDITIONS. FURTHER, TO THE MAXIMUM EXTENT PERMITTED BY APPLICABLE LAW, AGILENT DISCLAIMS ALL WARRANTIES, EITHER EXPRESS OR IMPLIED WITH REGARD TO THIS MANUAL AND ANY INFORMATION CONTAINED HEREIN, INCLUDING BUT NOT LIMITED TO THE IMPLIED WARRANTIES OF MERCHANTABILITY AND FITNESS FOR A PARTICULAR PURPOSE. AGILENT SHALL NOT BE LIABLE FOR ERRORS OR FOR INCIDENTAL OR CONSEQUENTIAL DAMAGES IN CONNECTION WITH THE FURNISHING, USE, OR PERFORMANCE OF THIS DOCUMENT OR ANY INFORMATION CONTAINED HEREIN. SHOULD AGILENT AND THE USER HAVE A SEPARATE WRITTEN AGREEMENT WITH WARRANTY TERMS COVERING THE MATERIAL IN THIS DOCUMENT THAT CONFLICT WITH THESE TERMS, THE WARRANTY TERMS IN THE SEPARATE AGREEMENT WILL CONTROL.

---

## DFARS/Restricted Rights Notice

If software is for use in the performance of a U.S. Government prime contract or subcontract, Software is delivered and licensed as "Commercial computer software" as defined in DFAR 252.227-7014 (June 1995), or as a "commercial item" as defined in FAR 2.101(a) or as "Restricted computer software" as defined in FAR 52.227-19 (June 1987) or any equivalent agency regulation or contract clause. Use, duplication or disclosure of Software is subject to Agilent Technologies' standard commercial license terms, and non-DOD Departments and Agencies of the U.S. Government will receive no greater than Restricted Rights as defined in FAR 52.227-19(c)(1-2) (June 1987). U.S. Government users will receive no greater than Limited Rights as defined in FAR 52.227-14 (June 1987) or DFAR 252.227-7015 (b)(2) (November 1995), as applicable in any technical data.

---

## Printing Copies of Documentation from the Web

To print copies of documentation from the Web, download the PDF file from the Agilent web site:

- Go to [www.agilent.com](http://www.agilent.com).
  - Enter the document's part number (located on the title page) in the **Search** box.
  - Click **SEARCH**.
  - Click on the hyperlink for the document.
  - Click the printer icon located in the tool bar.
-

---

## Contacting Agilent

Assistance with test and measurement needs and information on finding a local Agilent office are available on the Web at:

[www.agilent.com/find/assist](http://www.agilent.com/find/assist)

If you do not have access to the Internet, please contact your Agilent field engineer.

---

**NOTE** In any correspondence or telephone conversation, refer to the Agilent product by its model number and full serial number. With this information, the Agilent representative can determine whether your product is still within its warranty period.

---

---

**This page intentionally left blank.**

---

# Technical Specifications for the E8362B/C, E8363B/C, E8364B/C (Rev. 2008-10-03)

<b>Definitions</b> .....	4
<b>Corrected System Performance</b> .....	4
<b>Table 1.</b> System Dynamic Range.....	5
<b>Table 2.</b> Receiver Dynamic Range.....	7
<b>E8363B/C AND E8364B/C Corrected System Performance with 2.4mm Connectors</b> .....	9
<b>Table 3.</b> 85056A Calibration Kit Standard Configuration and Standard Power Range (E8363B/C AND E8364B/C).....	9
<b>Table 4.</b> 85056A Calibration Kit Fully Optioned (E836xB/C - Option 014, UNL, 016, 080, and 081).....	12
<b>Table 5.</b> 85056D Calibration Kit Standard Configuration and Standard Power Range (E8363B/C AND E8364B/C).....	15
<b>Table 6.</b> 85056D Calibration Kit Fully Optioned (E836xB/C - Option 014, UNL, 016, 080, and 081).....	18
<b>E8363B/C AND E8364B/C Corrected System Performance with 2.92mm Connectors</b> .....	21
<b>Table 7.</b> 85056K Calibration Kit Standard Configuration and Standard Power Range (E8363B/C AND E8364B/C).....	21
<b>Table 8.</b> 85056K Calibration Kit Fully Optioned (E836xB/C - Option 014, UNL, 016, 080, and 081).....	24
<b>E836xB/C Corrected System Performance with 3.5mm Connectors</b> .....	27
<b>Table 9.</b> 85052B Calibration Kit Standard Configuration and Standard Power Range (E836xB/C).....	27
<b>Table 10.</b> 85052B Calibration Kit Fully Optioned (E836xB/C - Option 014, UNL, 016, 080, and 081).....	30
<b>Table 11.</b> 85052C Calibration Kit Standard Configuration and Standard Power Range (E836xB/C).....	33
<b>Table 12.</b> 85052C Calibration Kit Fully Optioned (E836xB/C - Option 014, UNL, 016, 080, and 081).....	36
<b>Table 13.</b> 85052D Calibration Kit Standard Configuration and Standard Power Range (E836xB/C).....	39
<b>Table 14.</b> 85052D Calibration Kit Fully Optioned (E836xB/C - Option 014, UNL, 016, 080, and 081).....	42
<b>E836xB/C Corrected System Performance with 7mm Connectors</b> .....	45
<b>Table 15.</b> 85050B Calibration Kit Standard Configuration and Standard Power Range (E836xB/C).....	45
<b>Table 16.</b> 85050B Calibration Kit Fully Optioned (E836xB/C - Option 014, UNL, 016, 080, and 081).....	48
<b>Table 17.</b> 85050C Calibration Kit Standard Configuration and Standard Power Range (E836xB/C).....	51
<b>Table 18.</b> 85050C Calibration Kit Fully Optioned (E836xB/C - Option 014, UNL, 016, 080, and 081).....	54
<b>Table 19.</b> 85050D Calibration Kit Standard Configuration and Standard Power Range (E836xB/C).....	57
<b>Table 20.</b> 85050D Calibration Kit Fully Optioned (E836xB/C - Option 014, UNL, 016, 080, and 081).....	60
<b>E836xB/C Corrected System Performance with Type-N Connectors</b> .....	63
<b>Table 21.</b> 85054B Calibration Kit Standard Configuration and	

Standard Power Range (E836xB/C).....	63
<b>Table 22.</b> 85054B Calibration Kit Fully Optioned (E836xB/C - Option 014, UNL, 016, 080, and 081) .....	66
<b>Table 23.</b> 85054D Calibration Kit Standard Configuration and Standard Power Range (E836xB/C).....	69
<b>Table 24.</b> 85054D Calibration Kit Fully Optioned (E836xB/C - Option 014, UNL, 016, 080, and 081).....	72
<b>E8363B/C AND E8364B/C Corrected System Performance with WR-28 Connectors</b> .....	75
<b>Table 25.</b> R11644A Calibration Kit Standard Configuration and Standard Power Range (E8363B/C AND E8364B/C) .....	75
<b>Table 26.</b> R11644A Calibration Kit Fully Optioned (E836xB/C - Option 014, UNL, 016, 080, and 081).....	78
<b>E8363B/C AND E8364B/C Corrected System Performance with WR-42 Connectors</b> .....	81
<b>Table 27.</b> K11644A Calibration Kit Standard Configuration and Standard Power Range (E8363B/C AND E8364B/C) .....	81
<b>Table 28.</b> K11644A Calibration Kit Fully Optioned (E836xB/C - Option 014, UNL, 016, 080, and 081).....	84
<b>E836xB/C Corrected System Performance with WR-62 Connectors</b> .....	87
<b>Table 29.</b> P11644A Calibration Kit Standard Configuration and Standard Power Range (E836xB/C).....	87
<b>Table 30.</b> P11644A Calibration Kit Fully Optioned (E836xB/C - Option 014, UNL, 016, 080, and 081).....	90
<b>E836xB/C Corrected System Performance with WR-90 Connectors</b> .....	93
<b>Table 31.</b> X11644A Calibration Kit Standard Configuration and Standard Power Range (E836xB/C).....	93
<b>Table 32.</b> X11644A Calibration Kit Fully Optioned (E836xB/C - Option 014, UNL, 016, 080, and 081) .....	96
<b>Table 33.</b> Uncorrected System Performance .....	99
<b>Table 34.</b> Test Port Output .....	102
<b>Table 35:</b> Test Port Input.....	106
<b>Table 36.</b> Dynamic Accuracy (Specification).....	113
<b>Table 37.</b> Test Port Input (Group Delay).....	117
<b>General Information</b> .....	118
<b>Table 38. Miscellaneous Information</b> .....	118
<b>Table 39.</b> Front Panel Information.....	118
<b>Table 40.</b> Rear Panel Information.....	119
<b>Table 41.</b> Analyzer Dimensions and Weight .....	122
<b>Measurement Throughput Summary</b> .....	123
<b>Table 42</b> Typical Cycle Time (ms) for Measurement Completion .....	123
<b>Table 43.</b> Cycle Time vs IF Bandwidth.....	124
<b>Table 44.</b> Cycle Time vs Number of Points.....	124
<b>Table 45.</b> Frequency Converter Application (option 083) Cycle Time for Fixed-IF Measurements .....	125
<b>Table 46.</b> Data Transfer Time (ms) .....	125
<b>Specifications: Front-Panel Jumpers</b> .....	126
<b>Table 47:</b> Measurement Receiver Inputs (Rcvr A In, Rcvr B In).....	126

<b>Table 48:</b> Reference Receiver Inputs (Rcvr R1, Rcvr R2) .....	128
<b>Table 49:</b> Reference Outputs (Reference 1 Source Out, Reference 2 Source Out) .....	129
<b>Table 50:</b> Source Outputs (Port 1 Source Out, Port 2 Source Out) .....	130
<b>Table 51:</b> Coupler Inputs (Port 1 Cplr Thru, Port 2 Cplr Thru).....	132
<b>Table 52:</b> Coupler Outputs (Port 1 Cplr Arm, Port 2 Cplr Arm).....	133
<b>Test Set Block Diagrams</b> .....	134
E836xB/C - Standard Configuration and Standard Power Range .....	134
E836xB/C - Option UNL Standard Configuration with Extended Power Range and Bias - Tees .....	134
E836xB/C - Option UNL Standard Configuration with Extended Power Range and Bias - Tees, and Option 016, Receiver Attenuators.....	135
<b>Test Set with Option 014 Block Diagrams</b> .....	136
E836xB/C - Option 014 Configurable Test Set and Standard Power Range.....	136
E836xB/C - Option 014 Configurable Test Set and Standard Power Range, and Option 081 Reference Channel Transfer Switch.....	137
E836xB/C - Option 014 Configurable Test Set, and Option UNL Extended Power Range and Bias - Tees.....	138
E836xB/C - Option 014 Configurable Test Set, and Option UNL Extended Power Range and Bias - Tees, and Option 081 Reference Channel Transfer Switch .....	139
E836xB/C - Option 014 Configurable Test Set and Option UNL, Extended Power Range and Bias - Tees and Option 016 Receiver Attenuators .....	140
E836xB/C - Option 014 Configurable Test Set, and Option UNL Extended Power Range and Bias - Tees, and Option 016 Receiver Attenuators, and Option 081 Reference Channel Transfer Switch.....	141

## Definitions

All specifications and characteristics apply over a 25 °C ±5 °C range (unless otherwise stated) and 90 minutes after the instrument has been turned on.

**Specification (spec.):** Warranted performance. Specifications include guardbands to account for the expected statistical performance distribution, measurement uncertainties, and changes in performance due to environmental conditions.

**Characteristic (char.):** A performance parameter that the product is expected to meet before it leaves the factory, but that is not verified in the field and is not covered by the product warranty. A characteristic includes the same guardbands as a specification.

**Typical (typ.):** Expected performance of an average unit which does not include guardbands. It is not covered by the product warranty.

**Nominal (nom.):** A general, descriptive term that does not imply a level of performance. It is not covered by the product warranty.

**Calibration:** The process of measuring known standards to characterize a network analyzer's systematic (repeatable) errors.

**Corrected (residual):** Indicates performance after **error correction** (calibration). It is determined by the quality of calibration standards and how well "known" they are, plus system repeatability, stability, and noise.

**Uncorrected (raw):** Indicates instrument performance without error correction. The uncorrected performance affects the stability of a **calibration**.

**Standard:** When referring to the analyzer, this includes no options unless noted otherwise.

---

## Corrected System Performance

The specifications in this section apply for measurements made with the E836xB/C analyzer with the following conditions:

- 10 Hz IF bandwidth
- No averaging applied to data
- Isolation calibration with an averaging factor of 8



**Table 1. System Dynamic Range<sup>a</sup>**

Description	Specification (dB) at Test Port <sup>b</sup>	Typical (dB) at Direct Receiver Access Input <sup>c</sup>	Supplemental Information
<b>Dynamic Range (in a 10 Hz BW)</b>			
<b>Standard Configuration and Standard Power Range (E836xB/C - Standard)</b>			
10 MHz to 45 MHz <sup>d</sup>	79 (typical)	NA	--
45 MHz to 500 MHz <sup>e</sup>	94	NA	--
500 MHz to 2 GHz	119	NA	--
2 GHz to 10 GHz	122	NA	--
10 GHz to 20 GHz	123	NA	--
20 GHz to 30 GHz	114	NA	--
30 GHz to 40 GHz	110	NA	--
40 GHz to 45 GHz	109	NA	--
45 GHz to 50 GHz	104	NA	--
<b>Configurable Test Set and Standard Power Range (E836xB/C - Option 014)</b>			
10 MHz to 45 MHz <sup>d</sup>	79 (typical)	129	Option 016 degrades performance by 2 dB.
45 MHz to 500 MHz <sup>e</sup>	94	132	
500 MHz to 2 GHz	119	138	
2 GHz to 10 GHz	122	137	
10 GHz to 20 GHz	121	136	
20 GHz to 30 GHz	111	123	
30 GHz to 40 GHz	107	119	
40 GHz to 45 GHz	105	116	
45 GHz to 50 GHz	100	111	
<b>Standard Configuration and Extended Power Range &amp; Bias-Tees (E836xB/C - Option UNL)</b>			
10 MHz to 45 MHz <sup>d</sup>	79 (typical)	NA	Option 016 degrades performance by 2 dB.
45 MHz to 500 MHz <sup>e</sup>	92	NA	
500 MHz to 2 GHz	117	NA	
2 GHz to 10 GHz	120	NA	
10 GHz to 20 GHz	121	NA	
20 GHz to 30 GHz	112	NA	
30 GHz to 40 GHz	108	NA	
40 GHz to 45 GHz	105	NA	
45 GHz to 50 GHz	99	NA	
<b>Configurable Test Set and Extended Power Range &amp; Bias-Tees (E836xB/C - Option 014/UNL)</b>			
10 MHz to 45 MHz <sup>d</sup>	79 (typical)	129	Option 016 degrades performance by 2 dB.
45 MHz to 500 MHz <sup>e, f</sup>	92	130	
500 MHz to 2 GHz <sup>g</sup>	117	136	
2 GHz to 10 GHz <sup>h</sup>	120	135	
10 GHz to 20 GHz <sup>g</sup>	119	134	
20 GHz to 30 GHz	109	121	
30 GHz to 40 GHz	105	117	
40 GHz to 45 GHz	101	112	
45 GHz to 50 GHz	95	106	

<sup>a</sup> The system dynamic range is calculated as the difference between the noise floor and the source maximum output power. System dynamic range is a specification when the source is set to Port 1, and a characteristic when the source is set to Port 2. The effective dynamic range must take measurement uncertainties and interfering signals into account as well as the insertion loss resulting from a thru cable connected between Port 1 and Port 2..

<sup>b</sup> The test port system dynamic range is calculated as the difference between the test port noise floor and the source maximum output power. The effective dynamic range must take measurement uncertainties and interfering signals into account as well as the insertion loss resulting from a thru cable connected between Port 1 and Port 2..

<sup>c</sup> The direct receiver access input system dynamic range is calculated as the difference between the receiver access input noise floor and the source maximum output power. The effective dynamic range must take measurement uncertainties and interfering signals into account. This set-up should only be used when the receiver input will never exceed its damage level. When the analyzer is in segment sweep mode,

the analyzer can have predefined frequency segments which will output a higher power level when the extended dynamic range is required (i.e. devices with high insertion loss), and reduced power when receiver damage may occur (i.e. devices with low insertion loss). The extended range is only available in one-path transmission measurements.

<sup>d</sup> Typical performance.

<sup>e</sup> May be limited to 100 dB at particular frequencies below 500 MHz due to spurious receiver residuals. Methods are available to regain the full dynamic range.

<sup>f</sup> E8362B/C only: Option H11 decreases value by 1 dB.

<sup>g</sup> E8362B/C only: Option H11 decreases value by 2 dB.

**Table 2. Receiver Dynamic Range<sup>a</sup>**

Description	Specification (dB) at Test Port <sup>b</sup>	Typical (dB) at Direct Receiver Access Input <sup>c</sup>	
<b>Dynamic Range (in a 10 Hz BW)</b>			
<b>Standard Configuration and Standard Power Range (E836xB/C - Standard)</b>			
<b>OR</b>			
<b>Standard Configuration and Extended Power Range &amp; Bias Tees (E836xB/C - Option UNL)</b>			
10 MHz to 45 MHz <sup>d</sup>	82 (typical)	NA	--
45 MHz to 500 MHz <sup>e</sup>	94	NA	--
500 MHz to 2 GHz	119	NA	--
2 GHz to 10 GHz	122	NA	--
10 GHz to 20 GHz	125	NA	--
20 GHz to 30 GHz	114	NA	Option 016 degrades performance by 2 dB.
30 GHz to 40 GHz	111	NA	
40 GHz to 50 GHz	111	NA	
<b>Configurable Test Set and Standard Power Range (E836xB/C - Option 014)</b>			
<b>OR</b>			
<b>Configurable Test Set and Extended Power Range &amp; Bias Tees (E836xB/C - Option 014/UNL)</b>			
10 MHz to 45 MHz <sup>d</sup>	82 (typical)	132	--
45 MHz to 500 MHz <sup>e</sup>	94	132	--
500 MHz to 2 GHz	119	138	--
2 GHz to 10 GHz	122	137	--
10 GHz to 20 GHz	124	139	--
20 GHz to 30 GHz	113	125	Option 016 degrades performance by 2 dB.
30 GHz to 40 GHz	110	122	
40 GHz to 50 GHz	109	120	

<sup>a</sup> The receiver dynamic range is calculated as the difference between the noise floor and the receiver maximum output power. The effective dynamic range must take measurement uncertainties and interfering signals into account.

<sup>b</sup> The test port receiver dynamic range is calculated as the difference between the test port noise floor and the receiver maximum input level. The effective dynamic range must take measurement uncertainties and interfering signals into account.

<sup>c</sup> The direct receiver access input receiver dynamic range is calculated as the difference between the direct receiver access input noise floor and the receiver maximum input level. The effective dynamic range must take measurement uncertainties and interfering signals into account. This set-up should only be used when the receiver input will never exceed its compression or damage level. When the analyzer is in segment sweep mode, the analyzer can have predefined frequency segments which will output a higher power level when the extended dynamic range is required (i.e. devices with high insertion loss), and reduced power when compression or receiver damage may occur (i.e. devices with low insertion loss). The extended range is only available in one-path transmission measurements.

<sup>d</sup> Typical performance.

<sup>e</sup> May be degraded by 10 dB at particular frequencies (multiples of 5 MHz) below 500 MHz due to spurious receiver residuals. Methods are available to regain the full dynamic range.

**Note:** This E836xB/C document provides technical specifications for the following calibration kits only: 85056A, 85056D, 85056K, 85052B, 85052C, 85052D, 85050B, 85050C, 85050D, 85054B, 85054D, K11644A, P11644A, R11644A, and the X11644A.

**Table 2 (Continued).** Receiver Dynamic Range<sup>a</sup>

Description	Specification (dB) at Test Port <sup>b</sup>	Typical (dB) at Direct Receiver Access Input <sup>c</sup>	
<b>Dynamic Range (in a 10 Hz BW)</b>			
<b>Standard Configuration and Standard Power Range (E836xB/C - Standard)</b>			
<b>OR</b>			
<b>Standard Configuration and Extended Power Range &amp; Bias Tees (E836xB/C - Option UNL)</b>			
10 MHz to 45 MHz <sup>d</sup>	82 (typical)	NA	--
45 MHz to 500 MHz <sup>e</sup>	94	NA	--
500 MHz to 2 GHz	119	NA	--
2 GHz to 10 GHz	122	NA	--
10 GHz to 20 GHz	125	NA	--
20 GHz to 30 GHz	114	NA	Option 016 degrades performance by 2 dB.
30 GHz to 40 GHz	111	NA	
40 GHz to 50 GHz	111	NA	
<b>Configurable Test Set and Standard Power Range (E836xB/C - Option 014)</b>			
<b>OR</b>			
<b>Configurable Test Set and Extended Power Range &amp; Bias Tees (E836xB/C - Option 014/UNL)</b>			
10 MHz to 45 MHz <sup>d</sup>	82 (typical)	132	--
45 MHz to 500 MHz <sup>e</sup>	94	132	--
500 MHz to 2 GHz	119	138	--
2 GHz to 10 GHz	122	137	--
10 GHz to 20 GHz	124	139	--
20 GHz to 30 GHz	113	125	Option 016 degrades performance by 2 dB.
30 GHz to 40 GHz	110	122	
40 GHz to 50 GHz	109	120	

<sup>a</sup> The receiver dynamic range is calculated as the difference between the noise floor and the receiver maximum output power. The effective dynamic range must take measurement uncertainties and interfering signals into account.

<sup>b</sup> The test port receiver dynamic range is calculated as the difference between the test port noise floor and the receiver maximum input level. The effective dynamic range must take measurement uncertainties and interfering signals into account.

<sup>c</sup> The direct receiver access input receiver dynamic range is calculated as the difference between the direct receiver access input noise floor and the receiver maximum input level. The effective dynamic range must take measurement uncertainties and interfering signals into account. This set-up should only be used when the receiver input will never exceed its compression or damage level. When the analyzer is in segment sweep mode, the analyzer can have predefined frequency segments which will output a higher power level when the extended dynamic range is required (i.e. devices with high insertion loss), and reduced power when compression or receiver damage may occur (i.e. devices with low insertion loss). The extended range is only available in one-path transmission measurements.

<sup>d</sup> Typical performance.

<sup>e</sup> May be degraded by 10 dB at particular frequencies (multiples of 5 MHz) below 500 MHz due to spurious receiver residuals. Methods are available to regain the full dynamic range.

**Note:** This E836xB/C document provides technical specifications for the following calibration kits only: 85056A, 85056D, 85056K, 85052B, 85052C, 85052D, 85050B, 85050C, 85050D, 85054B, 85054D, K11644A, P11644A, R11644A, and the X11644A.

## E8363B/C AND E8364B/C Corrected System Performance with 2.4mm Connectors

**Table 3. 85056A Calibration Kit**  
**Standard Configuration and Standard Power Range**  
**(E8363B/C AND E8364B/C)**

Applies to the E8363B/C AND E8364B/C analyzers, 85056A (2.4mm) calibration kit, 85133F flexible test port cable set, and a full 2-port calibration. Also applies to the following condition:

Environmental temperature 23° ±3 °C, with < 1 °C deviation from calibration temperature

Description	Specification (dB)			
	45 MHz to 2 GHz	2 to 20 GHz	20 to 40 GHz	40 to 50 GHz
Directivity	42	42	38	36
Source Match	41	38	33	31
Load Match	42	42	37	35
Reflection Tracking	±0.001 +0.02/°C	±0.008 +0.02/°C	±0.020 +0.02/°C	±0.027 +0.03/°C
Transmission Tracking	±0.010 +0.02/°C	±0.049 +0.02/°C	±0.105 +0.02/°C	±0.170 +0.03/°C

NOTE: The following graphs also apply to the "C" model of the analyzers.

Transmission Uncertainty (Specifications)

Magnitude

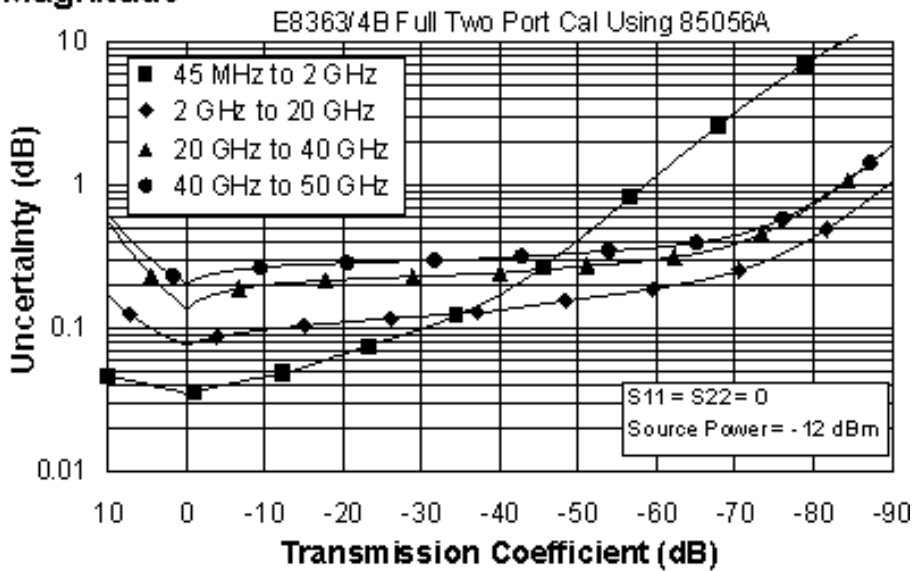

Phase

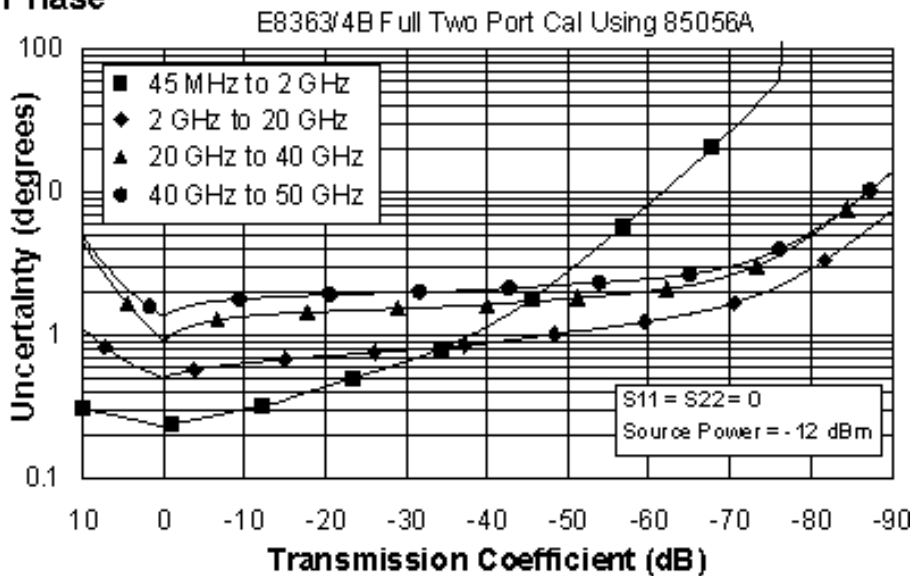

## Reflection Uncertainty (Specifications)

### Magnitude

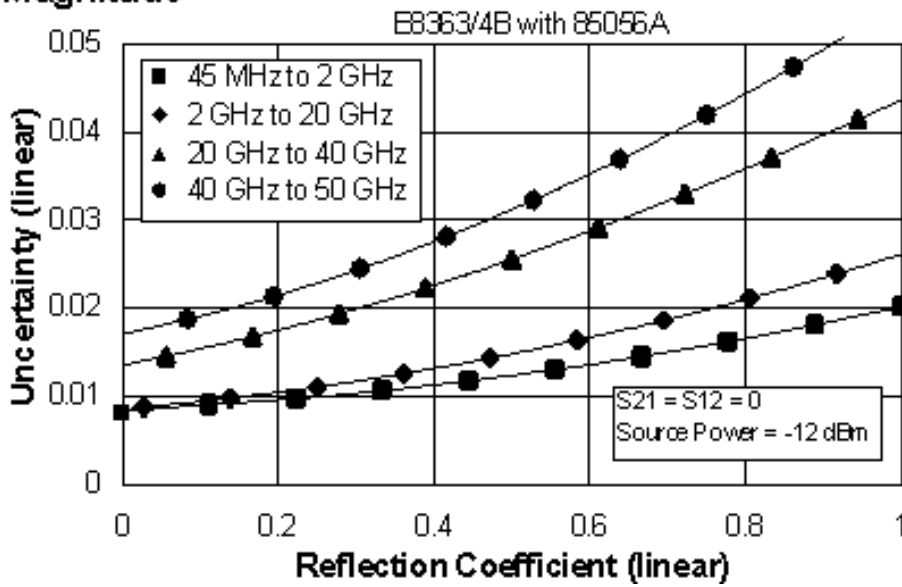

### Phase

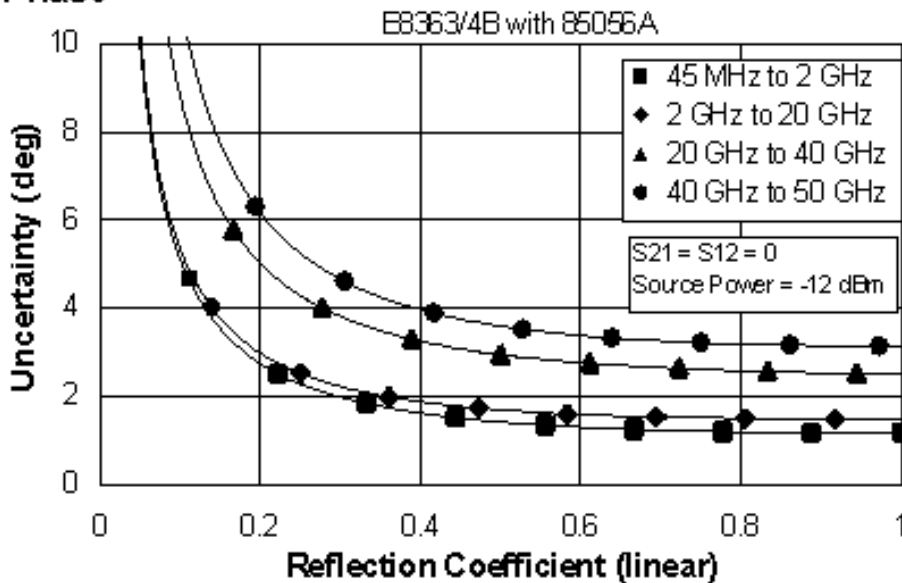

**Table 4. 85056A Calibration Kit**

Fully Optioned (E836xB/C - Option 014, UNL, 016, 080, and 081)

Configurable Test Set, Extended Power Range &amp; Bias-Tees, Receiver Attenuators, Frequency Offset Mode, and Reference Channel Transfer Switch

Applies to the, E8363B/C AND E8364B/C analyzers, 85056A (2.4mm) calibration kit, 85133F flexible test port cable set, and a full 2-port calibration. Also applies to the following condition:

Environmental temperature 23° ±3 °C, with &lt; 1 °C deviation from calibration temperature

Description	Specification (dB)			
	45 MHz to 2 GHz	2 to 20 GHz	20 to 40 GHz	40 to 50 GHz
Directivity	42	42	38	36
Source Match	41	38	33	31
Load Match	42	42	37	35
Reflection Tracking	±0.001 +0.02/°C	±0.008 +0.02/°C	±0.020 +0.02/°C	±0.027 +0.03/°C
Transmission Tracking	±0.019 +0.02/°C	±0.053 +0.02/°C	±0.109 +0.02/°C	±0.182 +0.03/°C



NOTE: The following graphs also apply to the “C” model of the analyzers.

**Transmission Uncertainty (Specifications)**

**Magnitude**

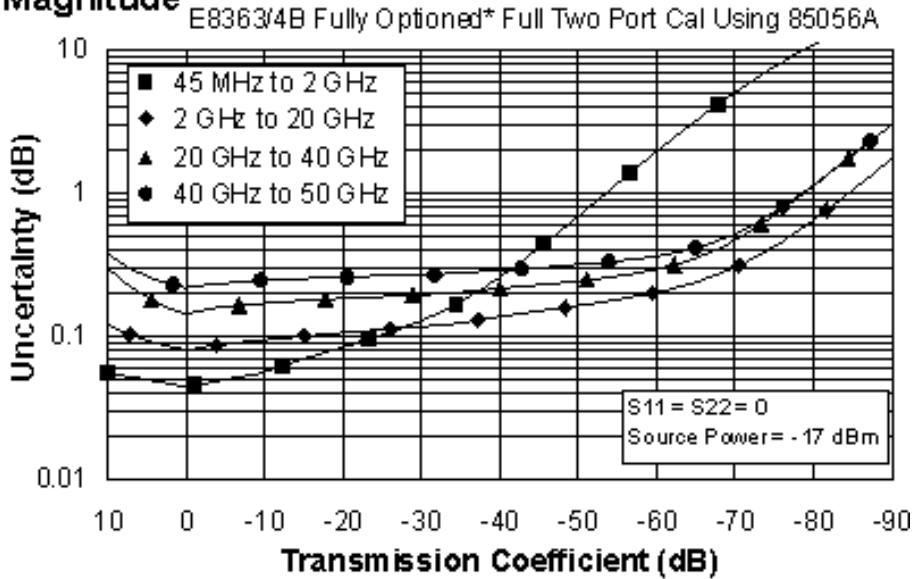

**Phase**

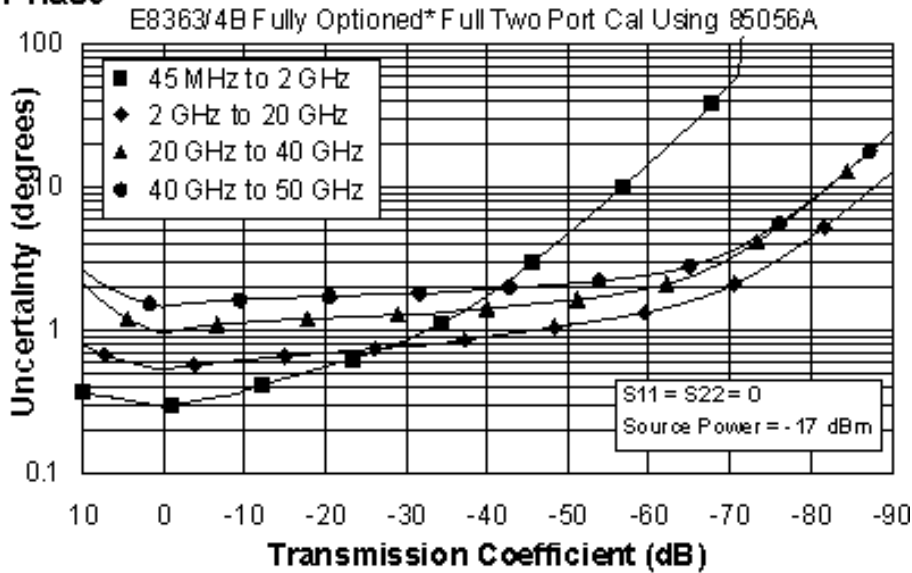

\* Configurable Test Set, Extended Power Range & Bias-Tees, Receiver Attenuators, Frequency Offset Mode, and Reference Channel Transfer Switch (E836xB/C - Option 014, UNL, 016, 080, and 081)

**Reflection Uncertainty (Specifications)**

**Magnitude**

E8363/4B Fully Optioned\* with 85056A

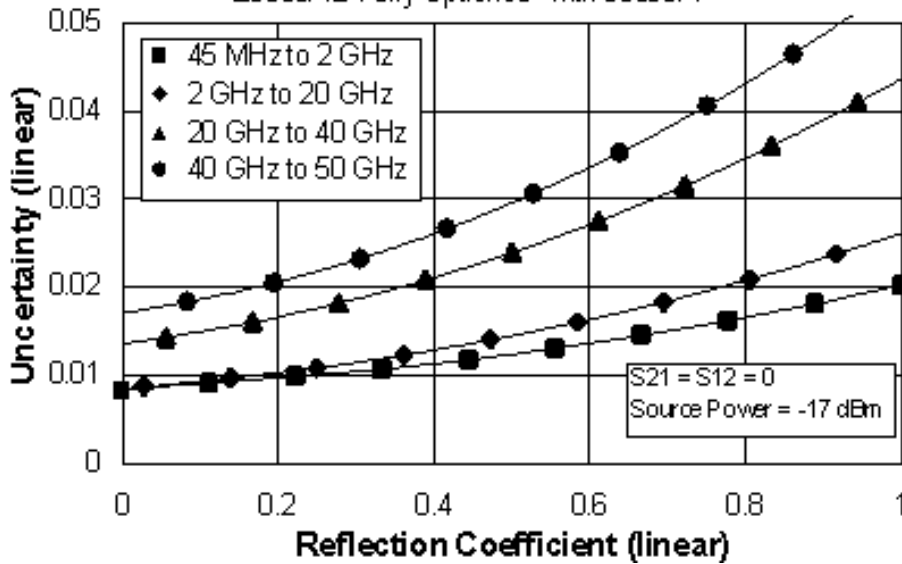

**Phase**

E8363/4B Fully Optioned\* with 85056A

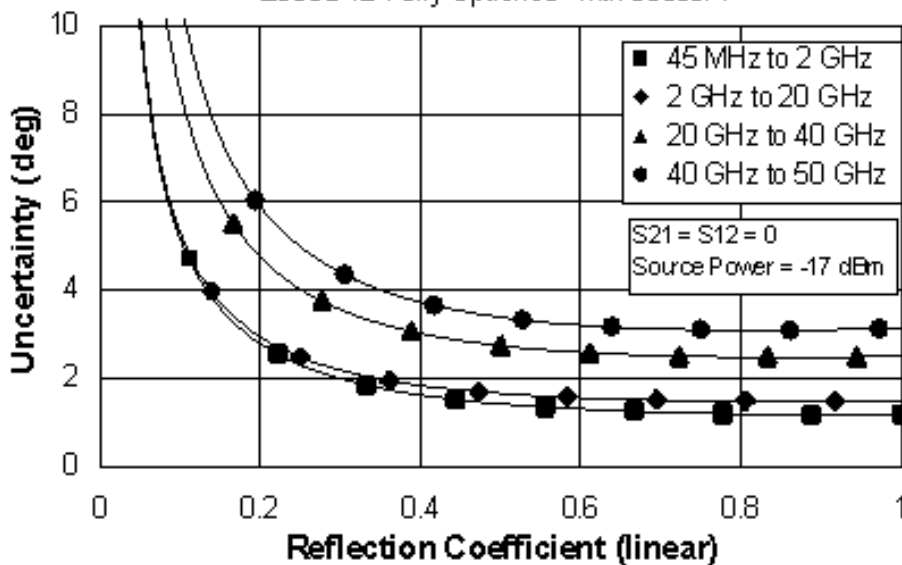

\* Configurable Test Set, Extended Power Range & Bias-Tees, Receiver Attenuators, Frequency Offset Mode, and Reference Channel Transfer Switch (E836xB/C - Option 014, UNL, 016, 080, and 081)

**Table 5. 85056D Calibration Kit**  
**Standard Configuration and Standard Power Range**  
**(E8363B/C AND E8364B/C)**

Applies to the, E8363B/C AND E8364B/C analyzers, 85056D (2.4mm) calibration kit, 85133F flexible test port cable set, and a full 2-port calibration. Also applies to the following condition:

Environmental temperature 23° ±3 °C, with < 1 °C deviation from calibration temperature

Description	Specification (dB)			
	45 MHz to 2 GHz	2 to 20 GHz	20 to 40 GHz	40 to 50 GHz
Directivity	42	34	26	26
Source Match	40	30	24	23
Load Match	42	33	25	25
Reflection Tracking	±0.002 +0.02/°C	±0.029 +0.02/°C	±0.079 +0.02/°C	±0.075 +0.03/°C
Transmission Tracking	±0.011 +0.02/°C	±0.121 +0.02/°C	±0.347 +0.02/°C	±0.462 +0.03/°C

NOTE: The following graphs also apply to the "C" model of the analyzers.

Transmission Uncertainty (Specifications)

Magnitude

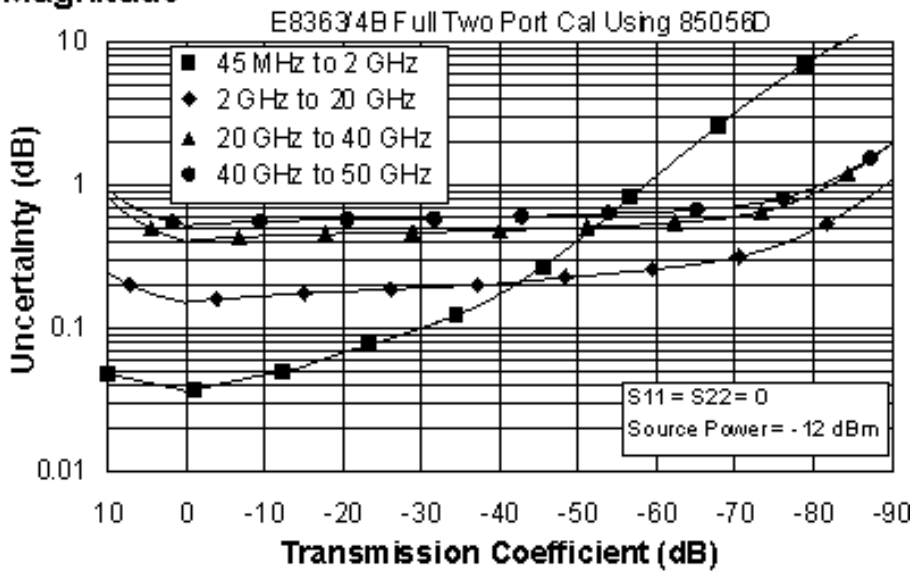

Phase

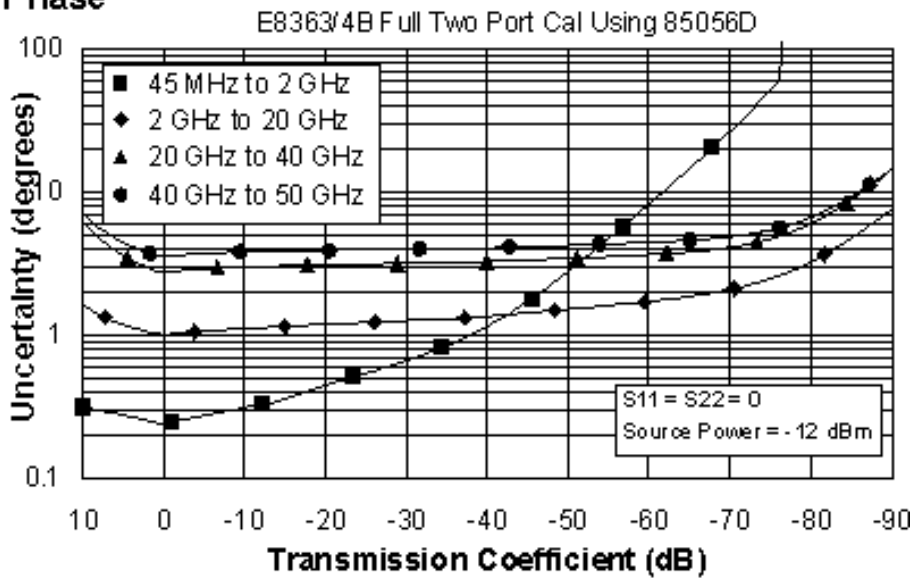

## Reflection Uncertainty (Specifications)

### Magnitude

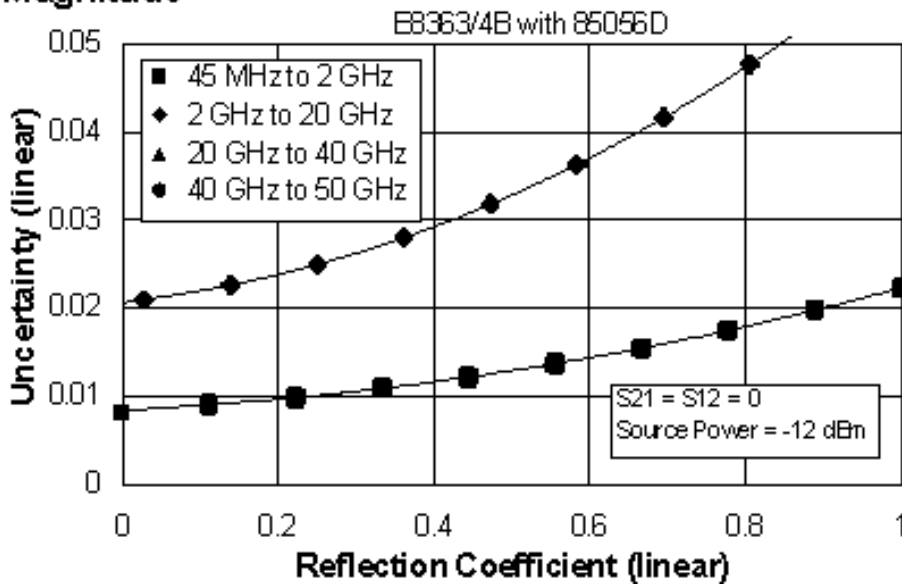

### Phase

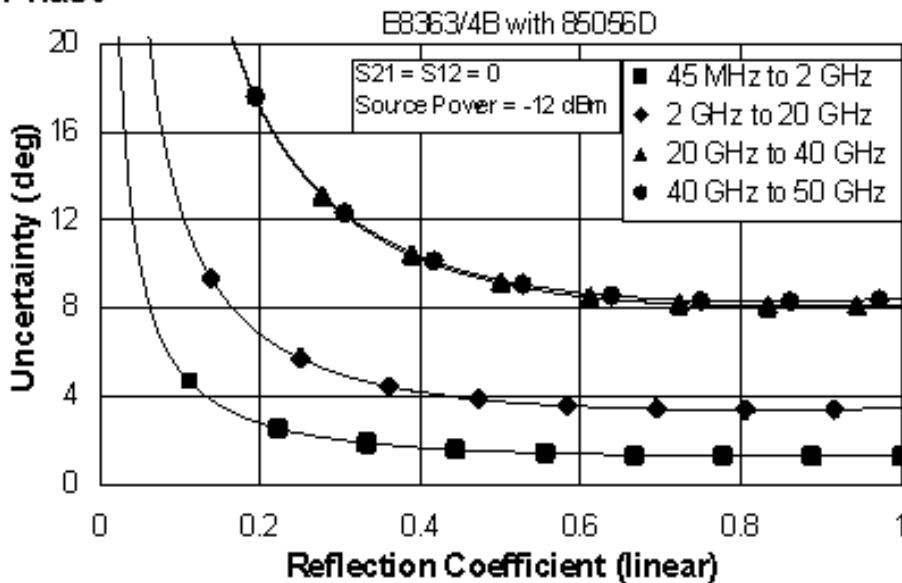

**Table 6. 85056D Calibration Kit**

Fully Optioned (E836xB/C - Option 014, UNL, 016, 080, and 081)

Configurable Test Set, Extended Power Range &amp; Bias-Tees, Receiver Attenuators, Frequency Offset Mode, and Reference Channel Transfer Switch

Applies to the, E8363B/C AND E8364B/C analyzers, 85056D (2.4mm) calibration kit, 85133F flexible test port cable set, and a full 2-port calibration. Also applies to the following condition:

Environmental temperature 23° ±3 °C, with &lt; 1 °C deviation from calibration temperature

Description	Specification (dB)			
	45 MHz to 2 GHz	2 to 20 GHz	20 to 40 GHz	40 to 50 GHz
Directivity	42	34	26	26
Source Match	40	30	24	23
Load Match	42	33	25	25
Reflection Tracking	±0.002 +0.02/°C	±0.029 +0.02/°C	±0.079 +0.02/°C	±0.075 +0.03/°C
Transmission Tracking	±0.022 +0.02/°C	±0.130 +0.02/°C	±0.365 +0.02/°C	±0.498 +0.03/°C

NOTE: The following graphs also apply to the “C” model of the analyzers.

**Transmission Uncertainty (Specifications)**

**Magnitude**

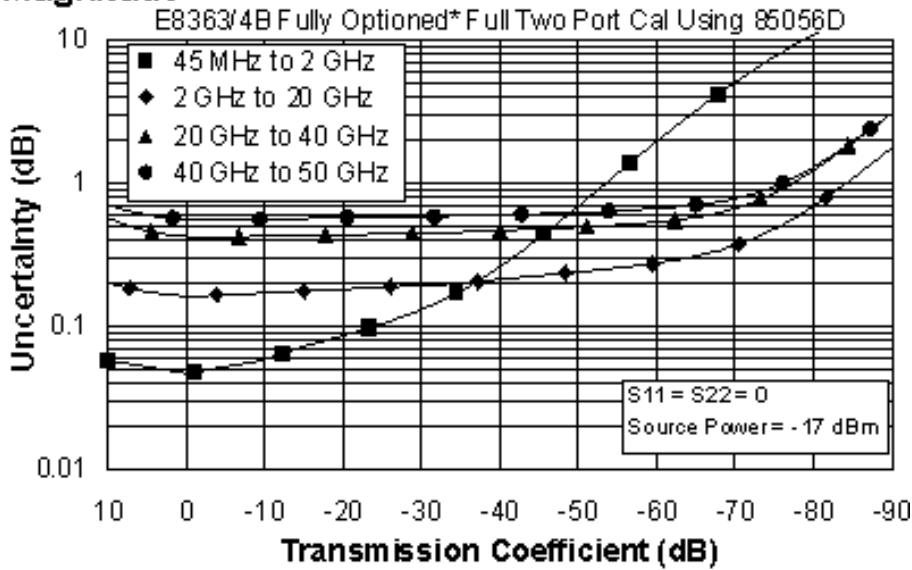

**Phase**

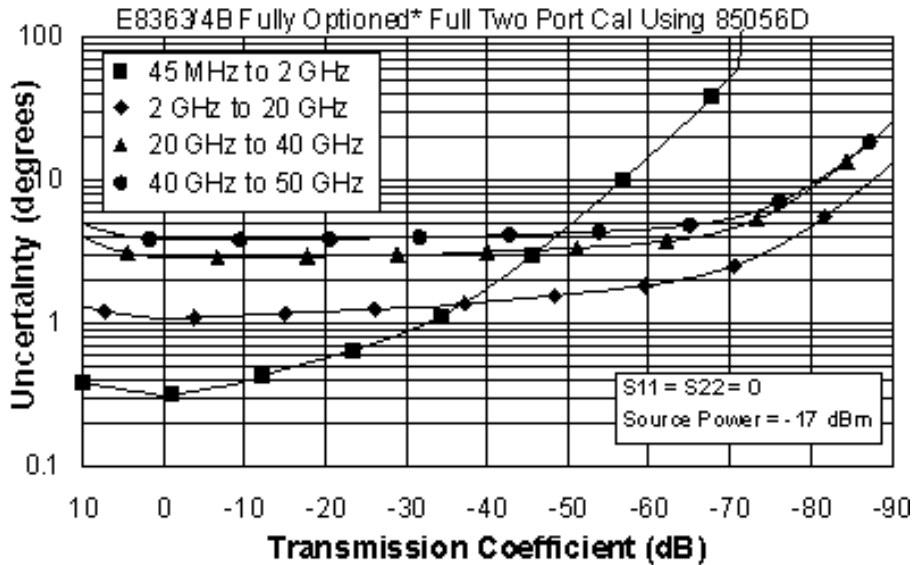

\* Configurable Test Set, Extended Power Range & Bias-Tees, Receiver Attenuators, Frequency Offset Mode, and Reference Channel Transfer Switch (E836xB/C - Option 014, UNL, 016, 080, and 081)

## Reflection Uncertainty (Specifications)

### Magnitude

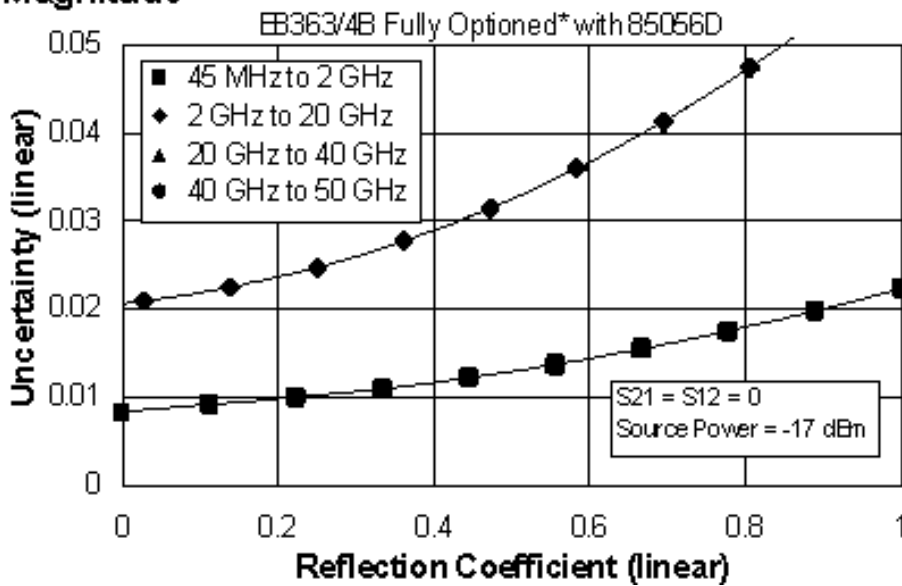

### Phase

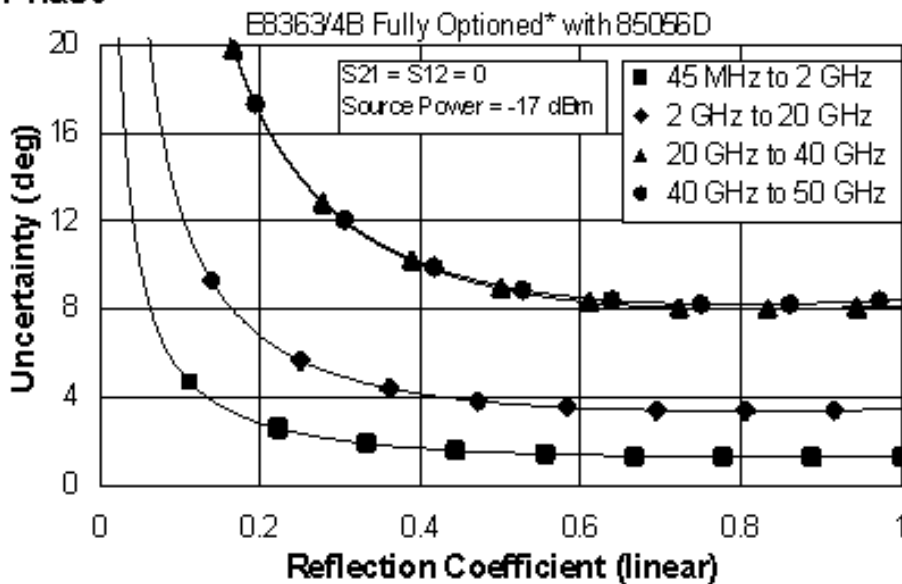

\* Configurable Test Set, Extended Power Range & Bias-Tees, Receiver Attenuators, Frequency Offset Mode, and Reference Channel Transfer Switch (E836xB/C - Option 014, UNL, 016, 080, and 081)



## E8363B/C AND E8364B/C Corrected System Performance with 2.92mm Connectors

**Table 7. 85056K Calibration Kit**

Standard Configuration and Standard Power Range

(E8363B/C AND E8364B/C)

Applies to the, E8363B/C AND E8364B/C analyzers, 85056K (2.92mm) calibration kit, 85133F flexible test port cable set, and a full 2-port calibration. Also applies to the following condition:

Environmental temperature 23° ±3 °C, with < 1 °C deviation from calibration temperature

Description	Specification (dB)		
	0.045 to 2 GHz	2 to 20 GHz	20 to 40 GHz
Directivity	42	42	40
Source Match	40	40	35
Load Match	42	41	38
Reflection Tracking	±0.018 +0.02/°C	±0.018 +0.02/°C	±0.067 +0.03/°C
Transmission Tracking	±0.011 +0.02/°C	±0.042 +0.02/°C	±0.089 +0.03/°C

NOTE: The following graphs also apply to the "C" model of the analyzers.

**Transmission Uncertainty (Specifications)**

**Magnitude**

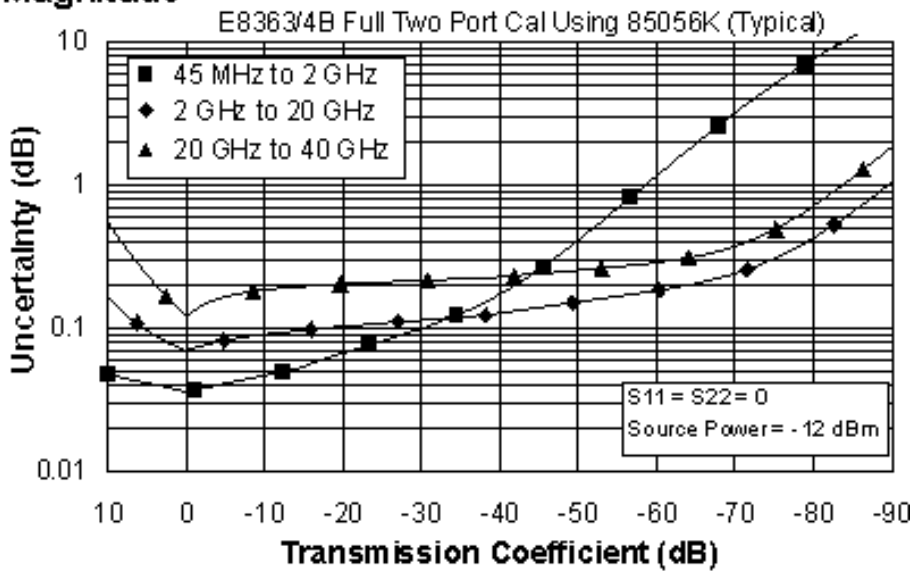

**Phase**

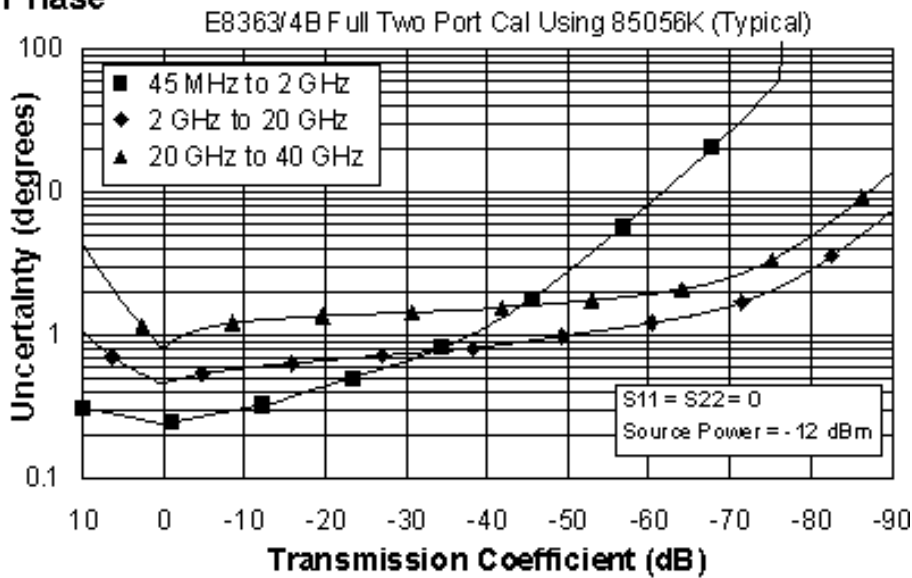

## Reflection Uncertainty (Specifications)

### Magnitude

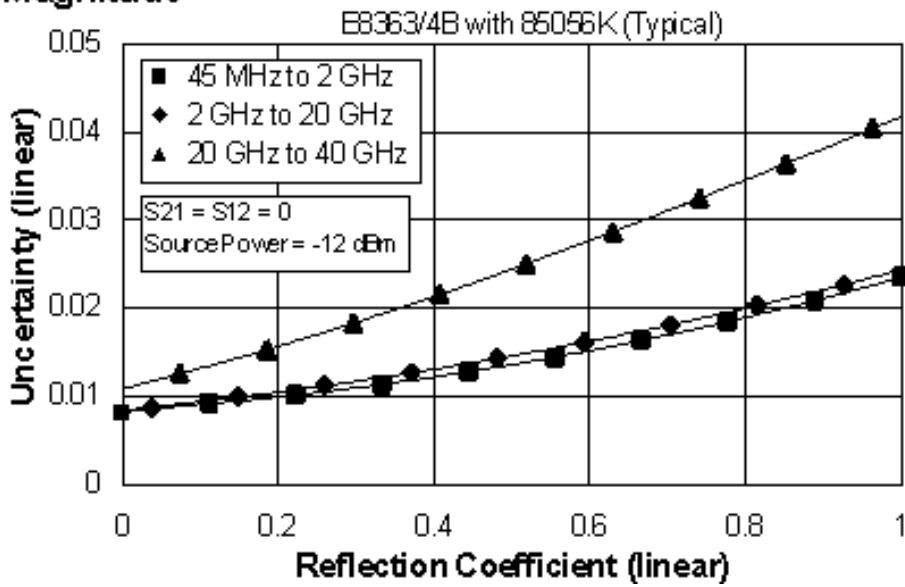

### Phase

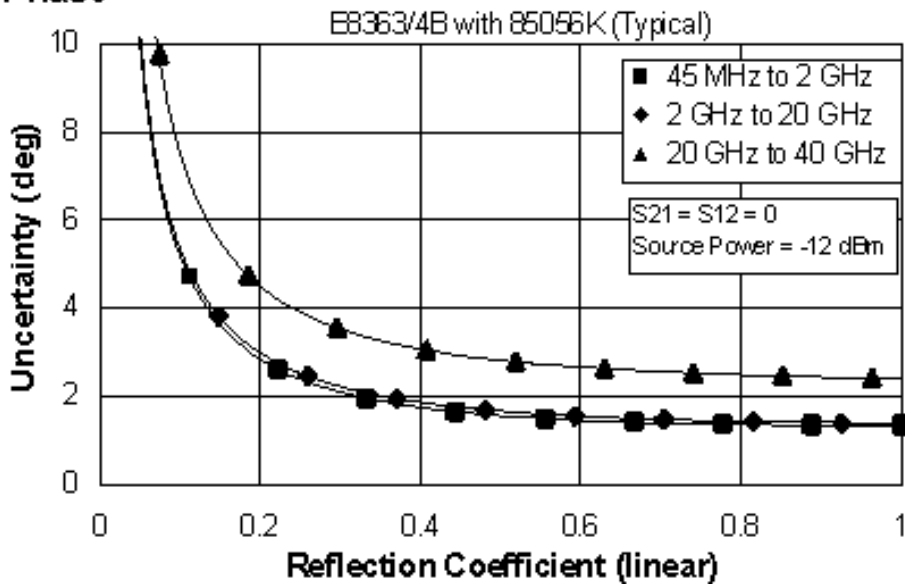

**Table 8. 85056K Calibration Kit**

Fully Optioned (E836xB/C - Option 014, UNL, 016, 080, and 081)

Configurable Test Set, Extended Power Range &amp; Bias-Tees, Receiver Attenuators, Frequency Offset Mode, and Reference Channel Transfer Switch

Applies to the, E8363B/C AND E8364B/C analyzers, 85056K (2.92mm) calibration kit, 85133F flexible test port cable set, and a full 2-port calibration. Also applies to the following condition:

Environmental temperature 23° ±3 °C, with &lt; 1 °C deviation from calibration temperature

Description	Specification (dB)		
	0.045 to 2 GHz	2 to 20 GHz	20 to 40 GHz
Directivity	42	42	40
Source Match	40	40	35
Load Match	42	41	38
Reflection Tracking	±0.018 +0.02/°C	±0.018 +0.02/°C	±0.067 +0.03/°C
Transmission Tracking	±0.021 +0.02/°C	±0.046 +0.02/°C	±0.094 +0.03/°C

NOTE: The following graphs also apply to the “C” model of the analyzers.

**Transmission Uncertainty (Specifications)**

**Magnitude**

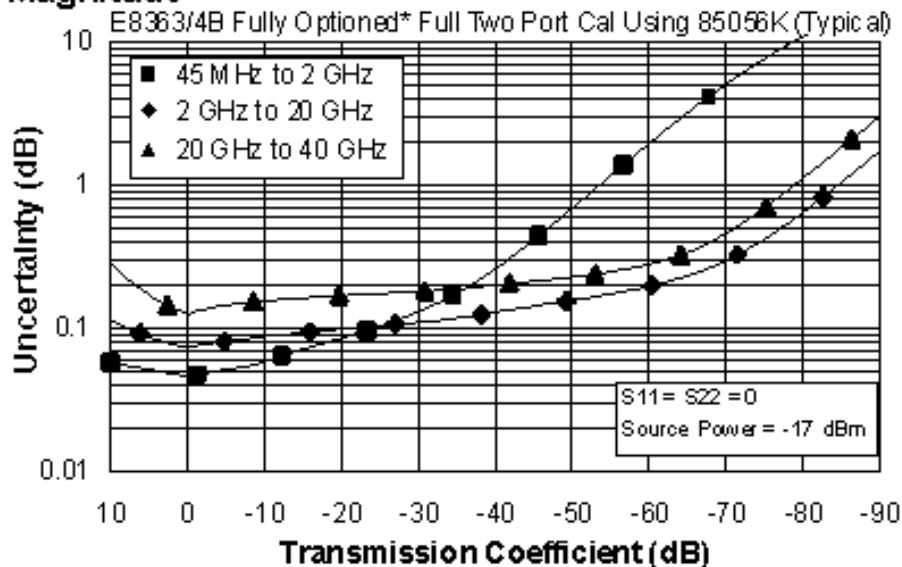

**Phase**

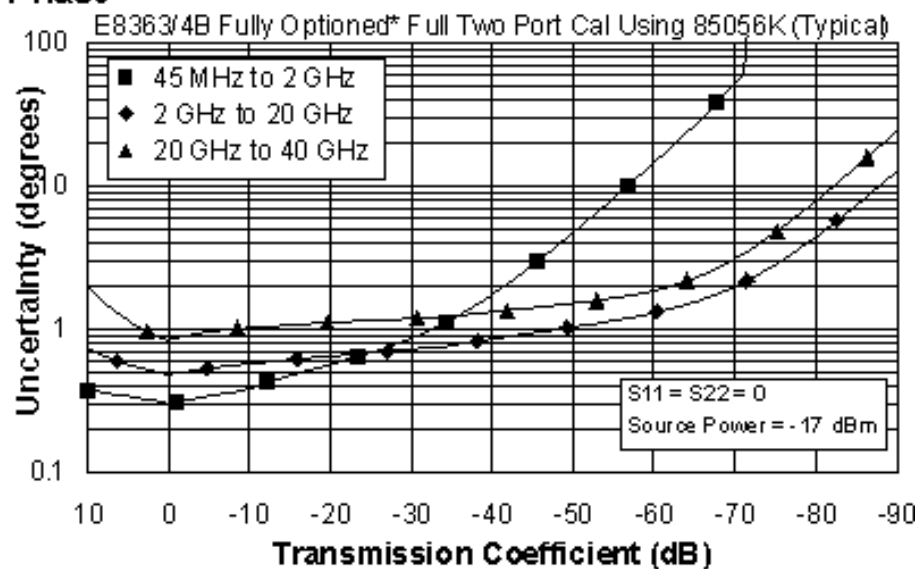

\* Configurable Test Set, Extended Power Range & Bias-Tees, Receiver Attenuators, Frequency Offset Mode, and Reference Channel Transfer Switch (E836xB/C - Option 014, UNL, 016, 080, and 081)

## Reflection Uncertainty (Specifications)

### Magnitude

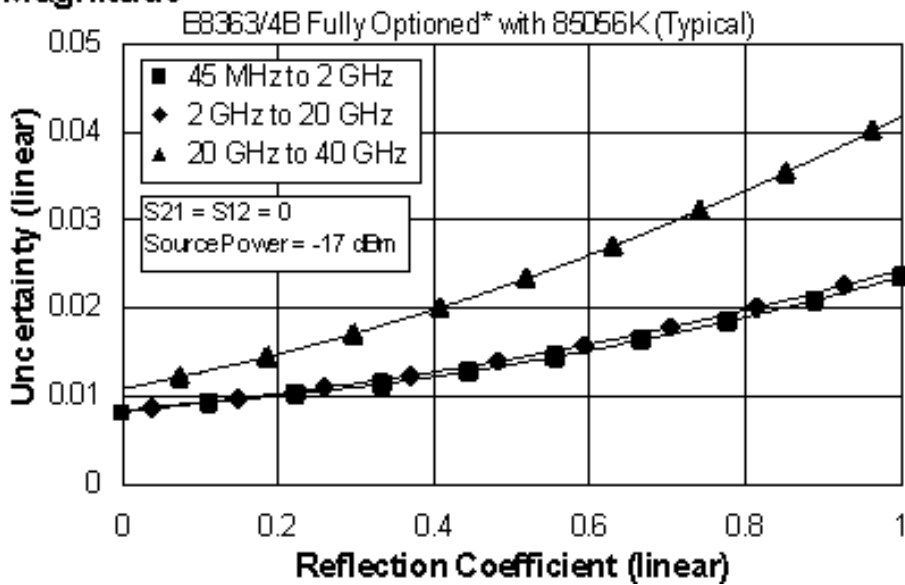

### Phase

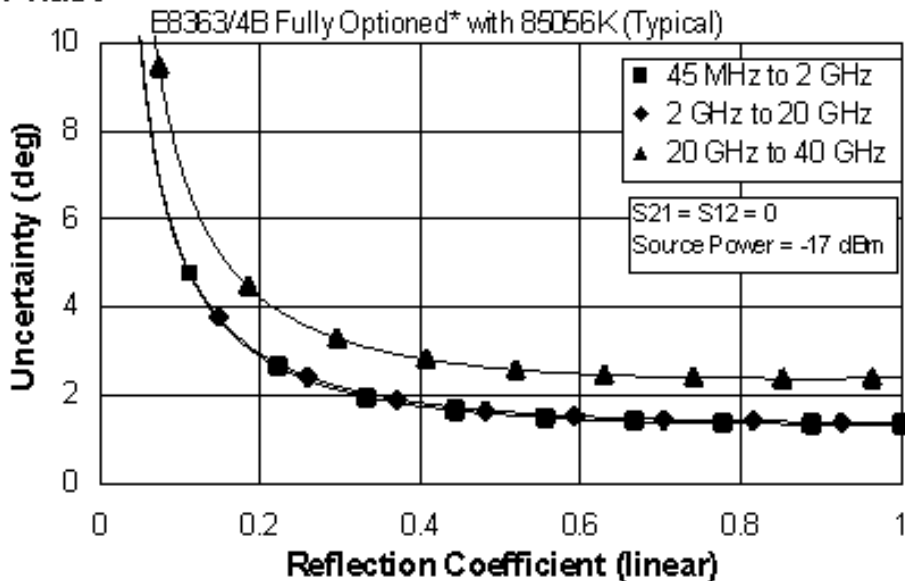

\* Configurable Test Set, Extended Power Range & Bias-Tees, Receiver Attenuators, Frequency Offset Mode, and Reference Channel Transfer Switch (E836xB/C - Option 014, UNL, 016, 080, and 081)

## E836xB/C Corrected System Performance with 3.5mm Connectors

---

**Table 9. 85052B Calibration Kit**  
**Standard Configuration and Standard Power Range**  
 (E836xB/C)

Applies to the, E836xB/C analyzers, 85052B (3.5mm) calibration kit, 85131F flexible test port cable set, and a full 2-port calibration. Data and traces above 20 GHz are not applicable to the E8362C. Also applies to the following condition:

Environmental temperature 23° ±3 °C, with < 1 °C deviation from calibration temperature

Description	Specification (dB)		
	45 MHz to 2 GHz	2 to 20 GHz	20 to 26.5 GHz
Directivity	48	44	44
Source Match	40	31	31
Load Match	48	44	44
Reflection Tracking	±0.003 +0.02/°C	±0.006 +0.02/°C	±0.006 +0.03/°C
Transmission Tracking	±0.009 +0.02/°C	±0.088 +0.02/°C	±0.104 +0.03/°C

NOTE: The following graphs also apply to the "C" model of the analyzers.

**Transmission Uncertainty (Specifications)**

**Magnitude**

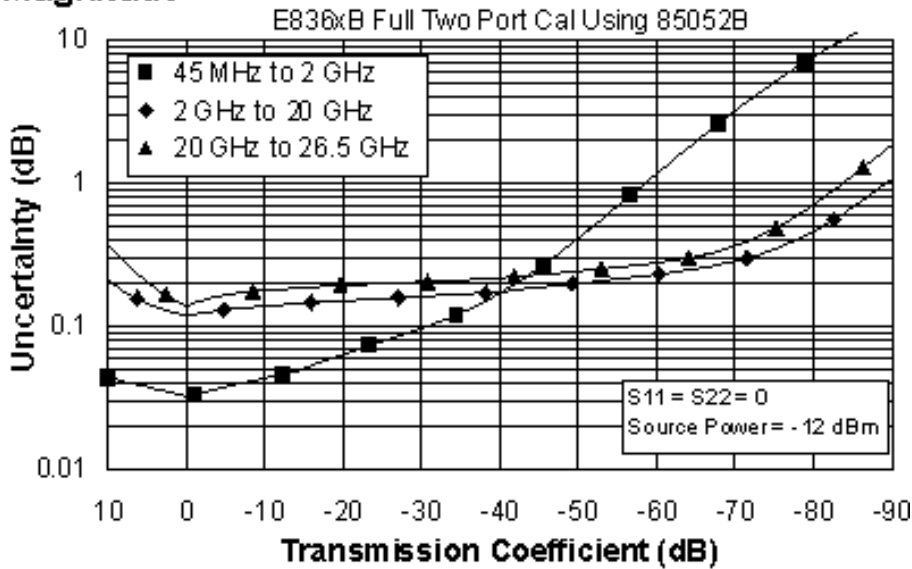

**Phase**

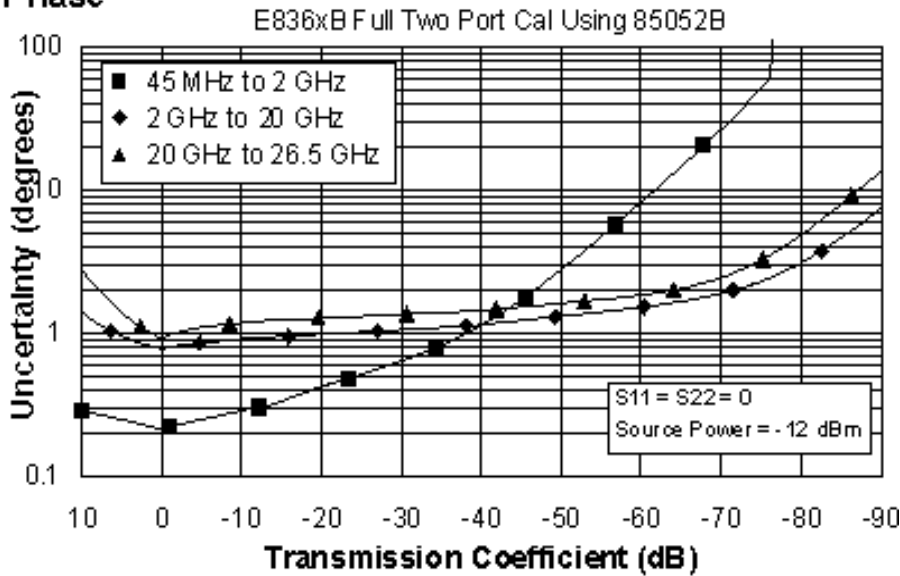



## Reflection Uncertainty (Specifications)

### Magnitude

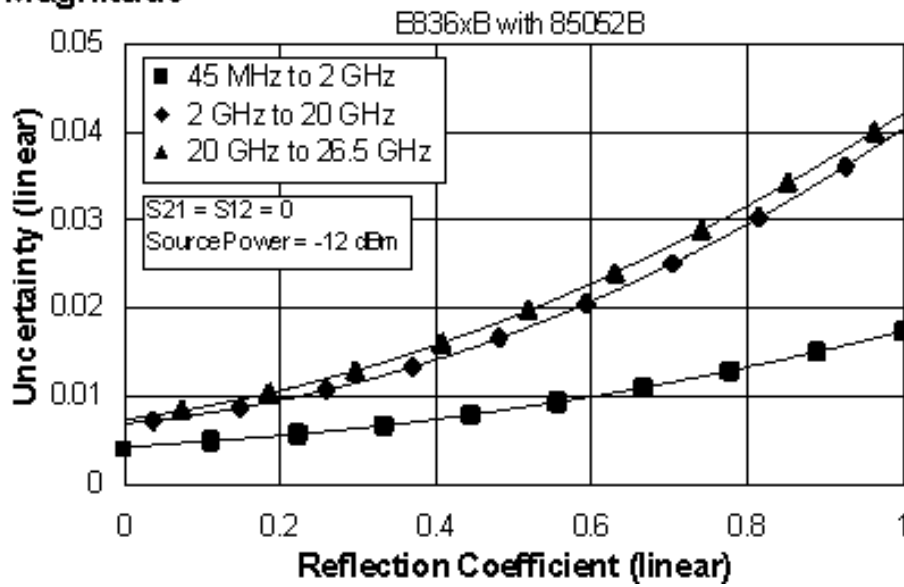

### Phase

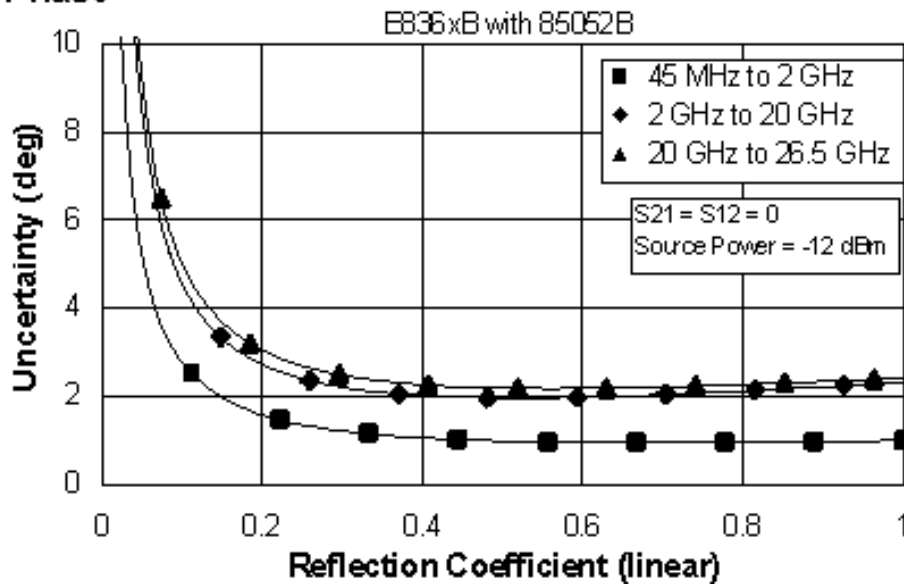

**Table 10. 85052B Calibration Kit**

Fully Optioned (E836xB/C - Option 014, UNL, 016, 080, and 081)

Configurable Test Set, Extended Power Range &amp; Bias-Tees, Receiver Attenuators, Frequency Offset Mode, and Reference Channel Transfer Switch

Applies to the, E836xB/C analyzers, 85052B (3.5mm) calibration kit, 85131F flexible test port cable set, and a full 2-port calibration. Data and traces above 20 GHz are not applicable to the E8362C. Also applies to the following condition:

Environmental temperature 23° ±3 °C, with &lt; 1 °C deviation from calibration temperature

Description	Specification (dB)		
	45 MHz to 2 GHz	2 to 20 GHz	20 to 26.5 GHz
Directivity	48	44	44
Source Match	40	31	31
Load Match	48	44	44
Reflection Tracking	±0.003 +0.02/°C	±0.006 +0.02/°C	±0.006 +0.03/°C
Transmission Tracking	±0.017 +0.02/°C	±0.091 +0.02/°C	±0.106 +0.03/°C

NOTE: The following graphs also apply to the “C” model of the analyzers.

**Transmission Uncertainty (Specifications)**

**Magnitude**

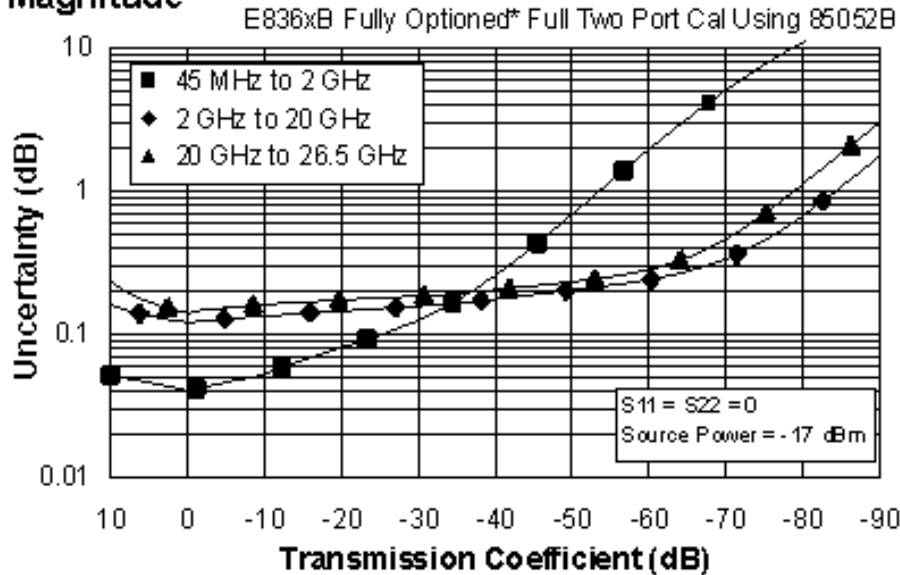

**Phase**

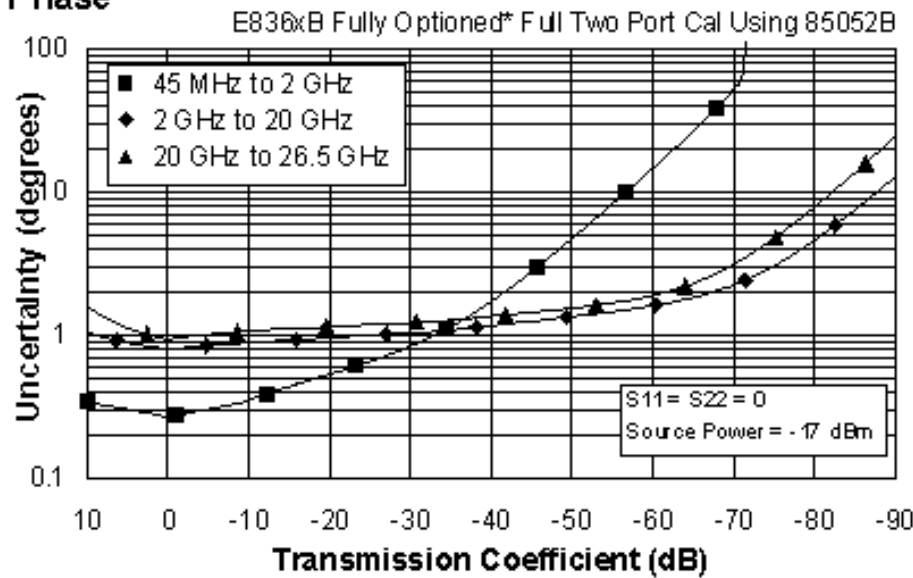

\* Configurable Test Set, Extended Power Range & Bias-Tees, Receiver Attenuators, Frequency Offset Mode, and Reference Channel Transfer Switch  
 (E836xB/C - Option 014, UNL, 016, 080, and 081)

## Reflection Uncertainty (Specifications)

### Magnitude

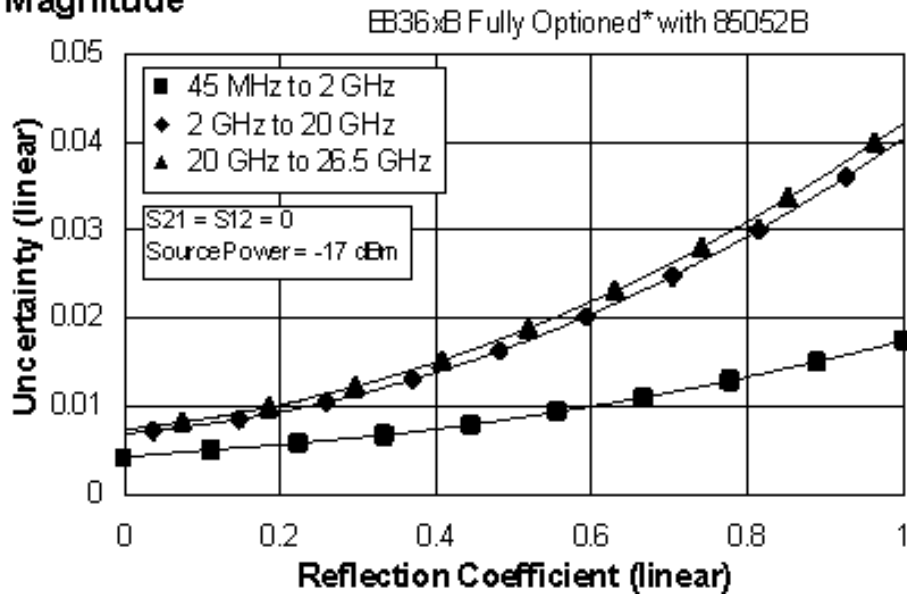

### Phase

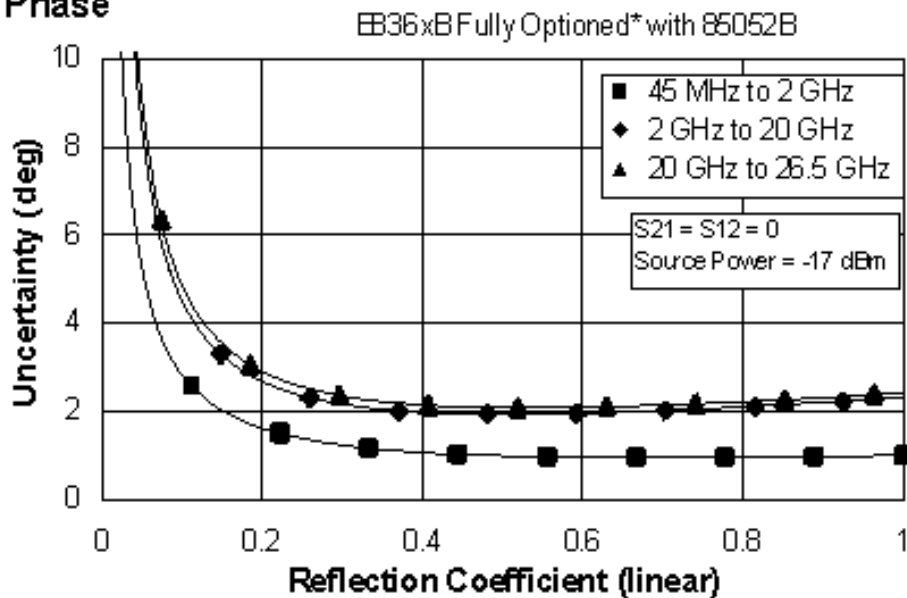

\* Configurable Test Set, Extended Power Range & Bias-Tees, Receiver Attenuators, Frequency Offset Mode, and Reference Channel Transfer Switch  
(E836xB/C - Option 014, UNL, 016, 080, and 081)

**Table 11. 85052C Calibration Kit**  
**Standard Configuration and Standard Power Range**  
 (E836xB/C)

Applies to the, E836xB/C analyzers, 85052C (3.5mm) calibration kit, 85131F flexible test port cable set, and a full 2-port calibration. Data and traces above 20 GHz are not applicable to the E8362C. Also applies to the following condition:

Environmental temperature 23° ±3 °C, with < 1 °C deviation from calibration temperature

Description	Specification (dB)		
	45 MHz to 2 GHz	2 to 20 GHz	20 to 26.5 GHz
Directivity	48	50	50
Source Match	40	50	50
Load Match	48	50	50
Reflection Tracking	±0.003 +0.02/°C	±0.000 +0.02/°C	±0.000 +0.03/°C
Transmission Tracking	±0.009 +0.02/°C	±0.014 +0.02/°C	±0.018 +0.03/°C

NOTE: The following graphs also apply to the "C" model of the analyzers.

**Transmission Uncertainty (Specifications)**

**Magnitude**

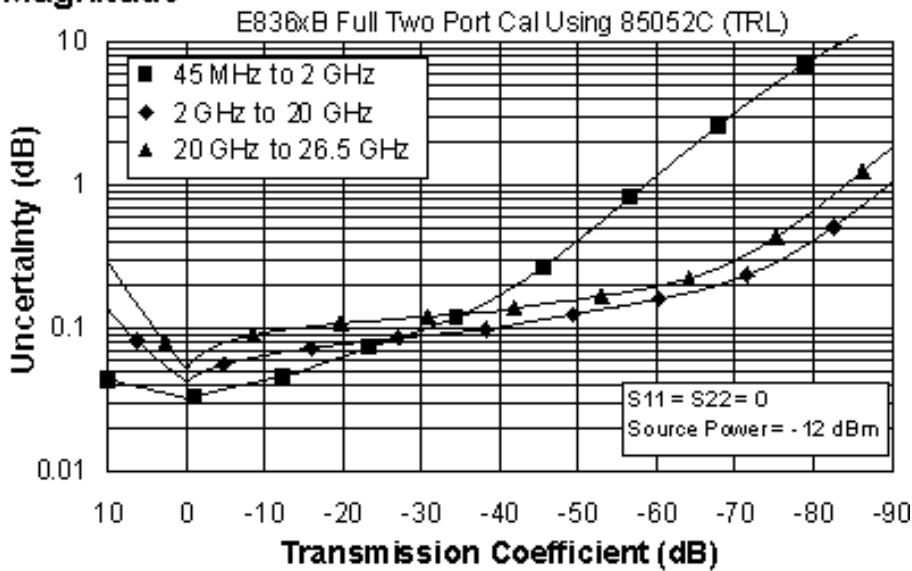

**Phase**

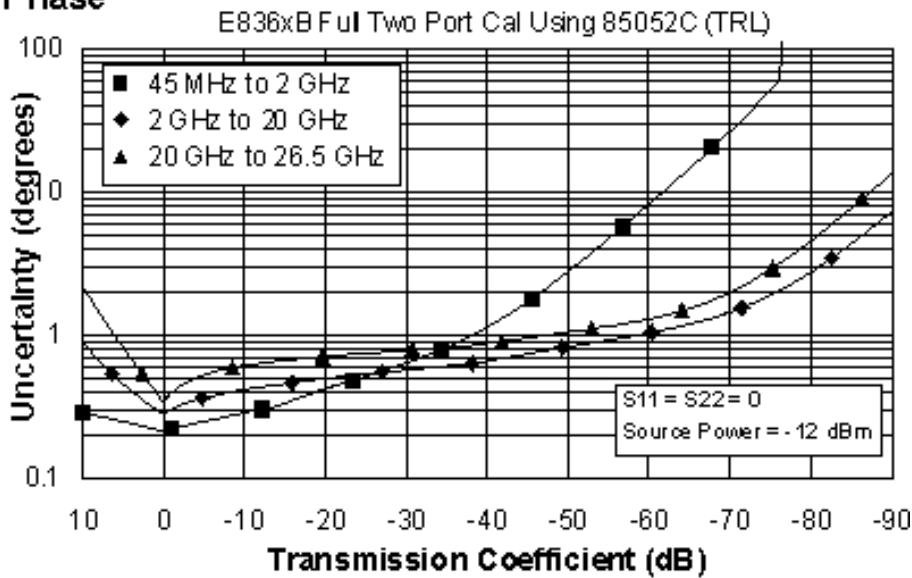

## Reflection Uncertainty (Specifications)

### Magnitude

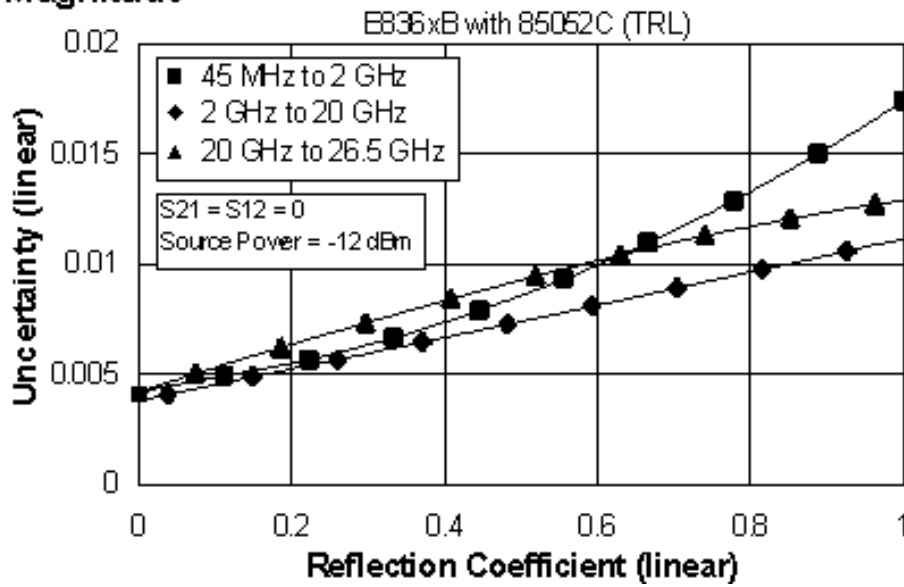

### Phase

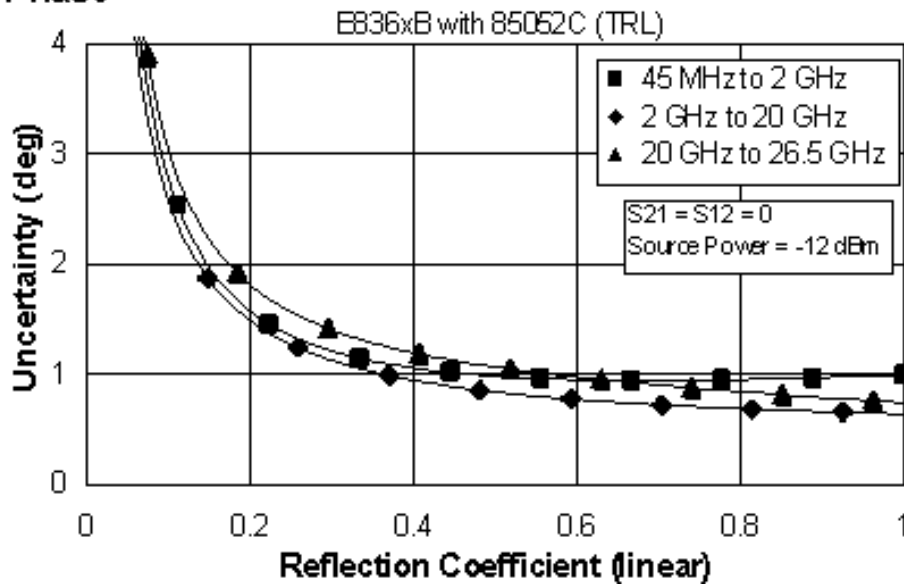

**Table 12. 85052C Calibration Kit**

Fully Optioned (E836xB/C - Option 014, UNL, 016, 080, and 081)

Configurable Test Set, Extended Power Range &amp; Bias-Tees, Receiver Attenuators, Frequency Offset Mode, and Reference Channel Transfer Switch

Applies to the, E836xB/C analyzers, 85052C (3.5mm) calibration kit, 85131F flexible test port cable set, and a full 2-port calibration. Data and traces above 20 GHz are not applicable to the E8362C. Also applies to the following condition:

Environmental temperature 23° ±3 °C, with &lt; 1 °C deviation from calibration temperature

Description	Specification (dB)		
	45 MHz to 2 GHz	2 to 20 GHz	20 to 26.5 GHz
Directivity	48	50	50
Source Match	40	50	50
Load Match	48	50	50
Reflection Tracking	±0.003 +0.02/°C	±0.000 +0.02/°C	±0.000 +0.03/°C
Transmission Tracking	±0.017 +0.02/°C	±0.016 +0.02/°C	±0.019 +0.03/°C



NOTE: The following graphs also apply to the “C” model of the analyzers.

**Transmission Uncertainty (Specifications)**

**Magnitude**

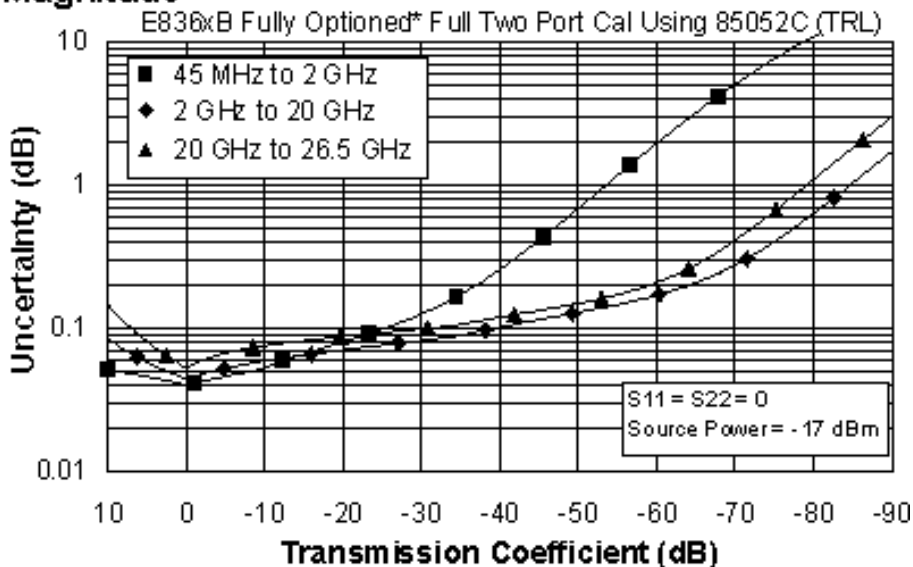

**Phase**

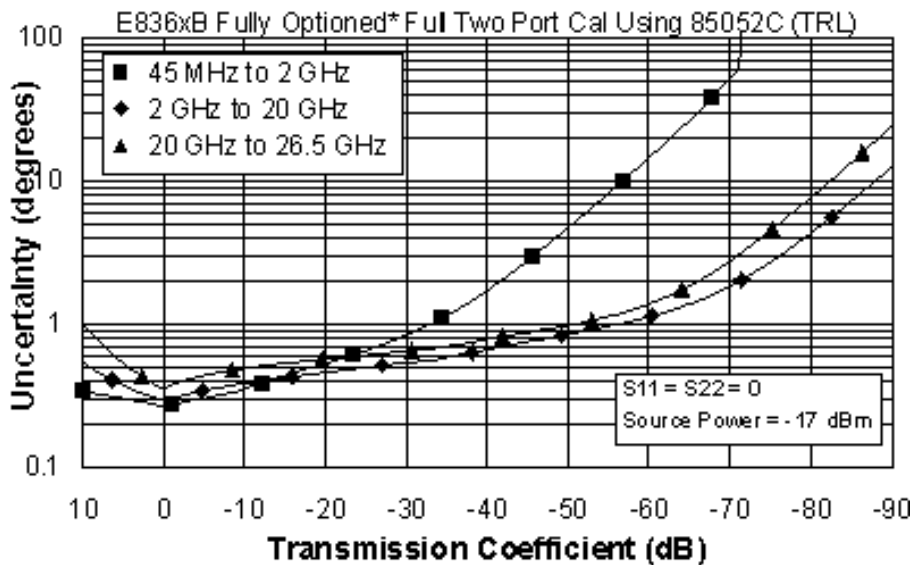

\* Configurable Test Set, Extended Power Range & Bias-Tees, Receiver Attenuators, Frequency Offset Mode, and Reference Channel Transfer Switch  
 (E836xB/C - Option 014, UNL, 016, 080, and 081)

## Reflection Uncertainty (Specifications)

### Magnitude

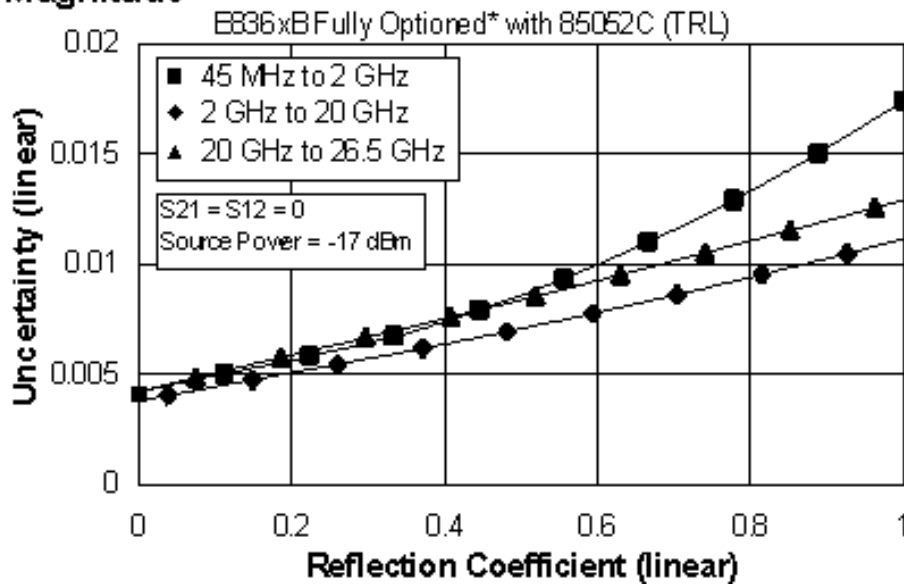

### Phase

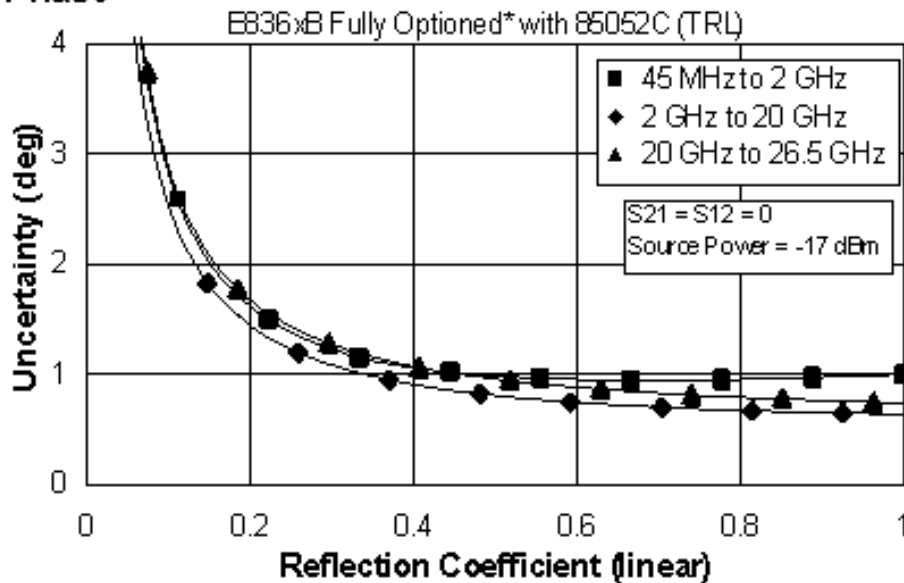

\* Configurable Test Set, Extended Power Range & Bias-Tees, Receiver Attenuators, Frequency Offset Mode, and Reference Channel Transfer Switch  
(E836xB/C - Option 014, UNL, 016, 080, and 081)

**Table 13. 85052D Calibration Kit**  
**Standard Configuration and Standard Power Range**  
 (E836xB/C)

Applies to the, E836xB/C analyzers, 85052D (3.5mm) calibration kit, 85131F flexible test port cable set, and a full 2-port calibration. Data and traces above 20 GHz are not applicable to the E8362C. Also applies to the following condition:

Environmental temperature 23° ±3 °C, with < 1 °C deviation from calibration temperature

Description	Specification (dB)		
	45 MHz to 2 GHz	2 to 20 GHz	20 to 26.5 GHz
Directivity	42	36	30
Source Match	37	28	25
Load Match	42	36	30
Reflection Tracking	±0.003 +0.02/°C	±0.008 +0.02/°C	±0.011 +0.03/°C
Transmission Tracking	±0.014 +0.02/°C	±0.131 +0.02/°C	±0.250 +0.03/°C

NOTE: The following graphs also apply to the "C" model of the analyzers.

**Transmission Uncertainty (Specifications)**

**Magnitude**

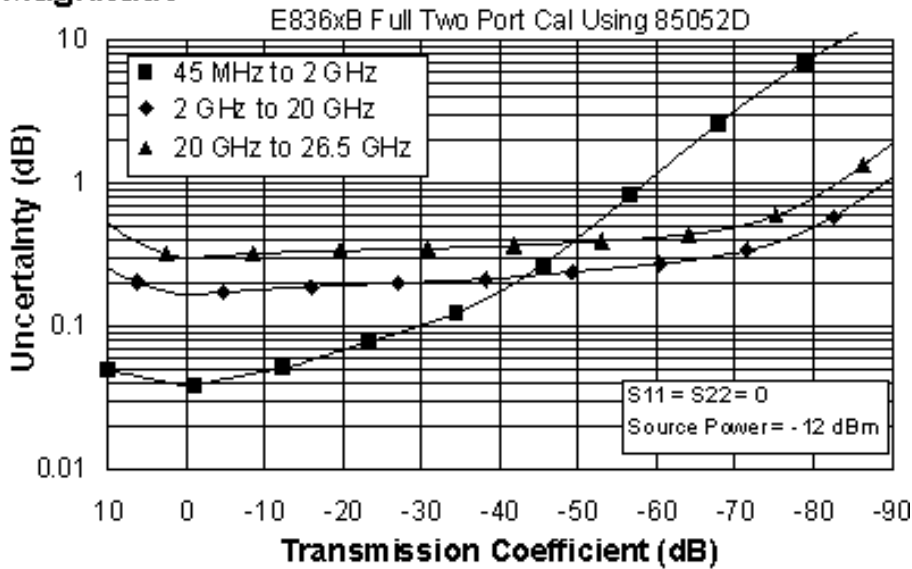

**Phase**

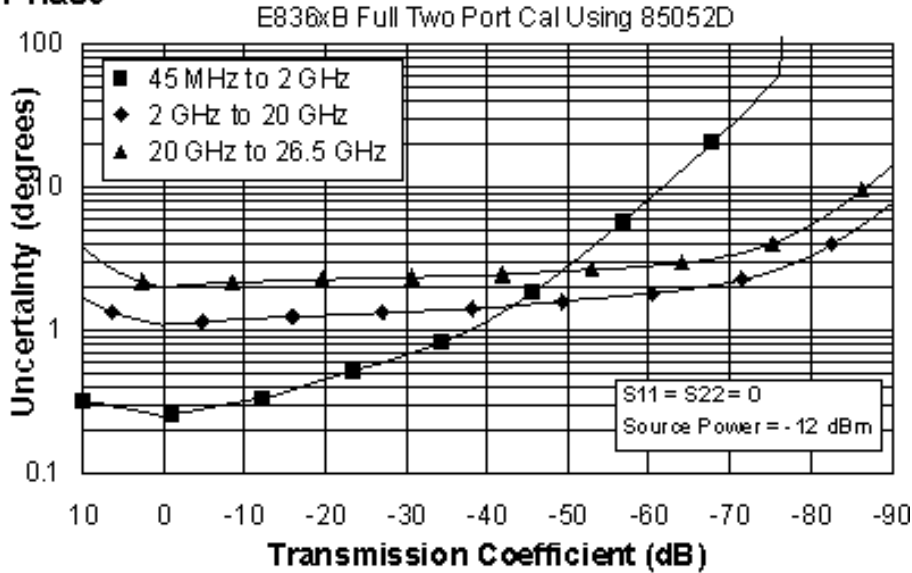

## Reflection Uncertainty (Specifications)

### Magnitude

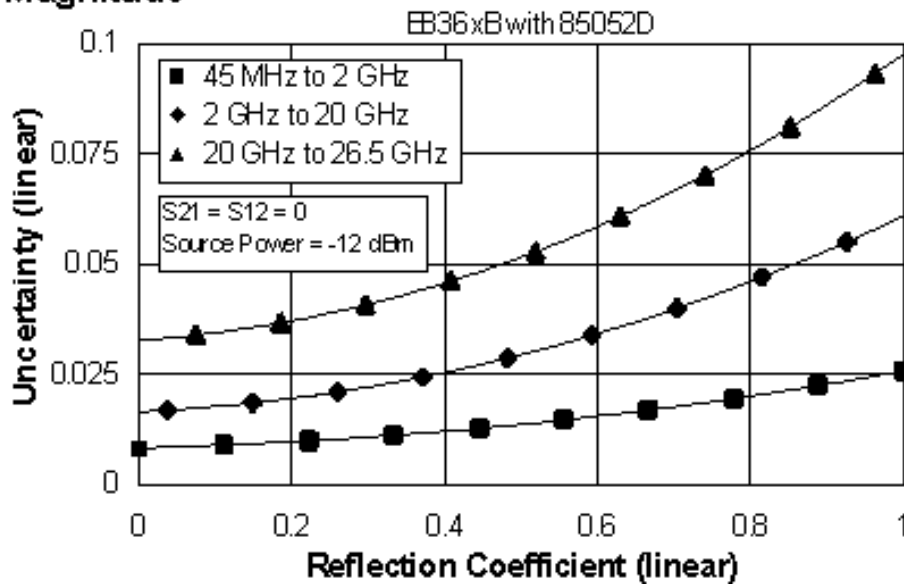

### Phase

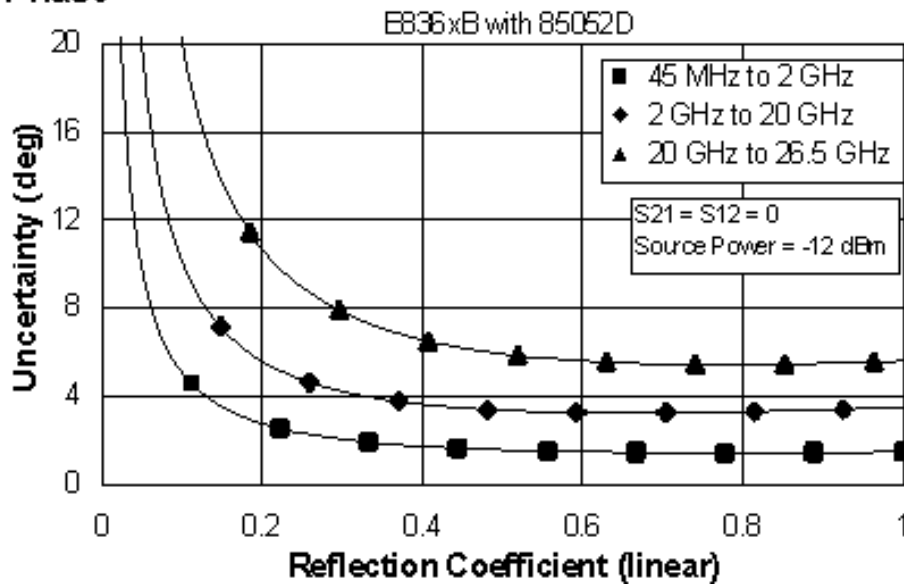

**Table 14. 85052D Calibration Kit**

Fully Optioned (E836xB/C - Option 014, UNL, 016, 080, and 081)

Configurable Test Set, Extended Power Range &amp; Bias-Tees, Receiver Attenuators, Frequency Offset Mode, and Reference Channel Transfer Switch

Applies to the, E836xB/C analyzers, 85052D (3.5mm) calibration kit, 85131F flexible test port cable set, and a full 2-port calibration. Data and traces above 20 GHz are not applicable to the E8362C. Also applies to the following condition:

Environmental temperature 23° ±3 °C, with &lt; 1 °C deviation from calibration temperature

Description	Specification (dB)		
	45 MHz to 2 GHz	2 to 20 GHz	20 to 26.5 GHz
Directivity	42	36	30
Source Match	37	28	25
Load Match	42	36	30
Reflection Tracking	±0.003 +0.02/°C	±0.008 +0.02/°C	±0.011 +0.03/°C
Transmission Tracking	±0.026 +0.02/°C	±0.138 +0.02/°C	±0.261 +0.03/°C

NOTE: The following graphs also apply to the “C” model of the analyzers.

**Transmission Uncertainty (Specifications)**

**Magnitude**

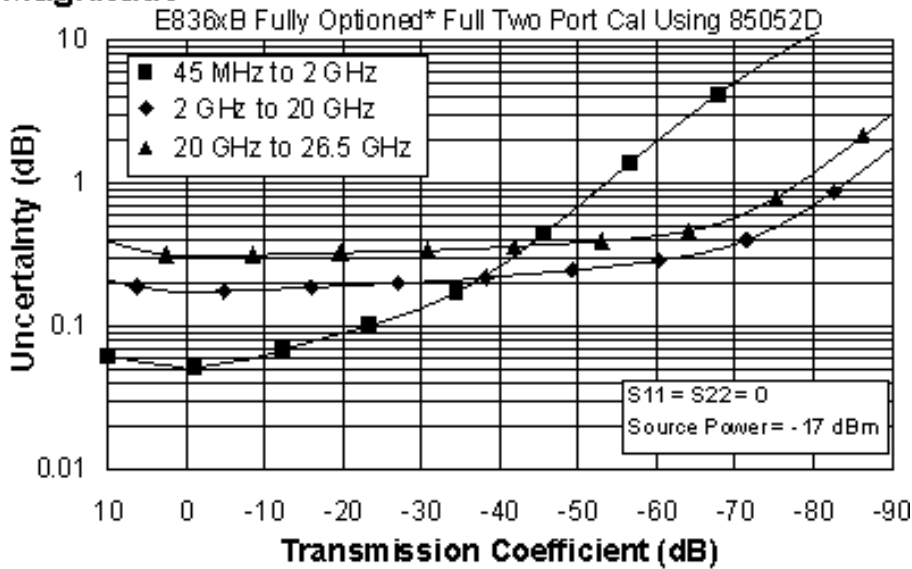

**Phase**

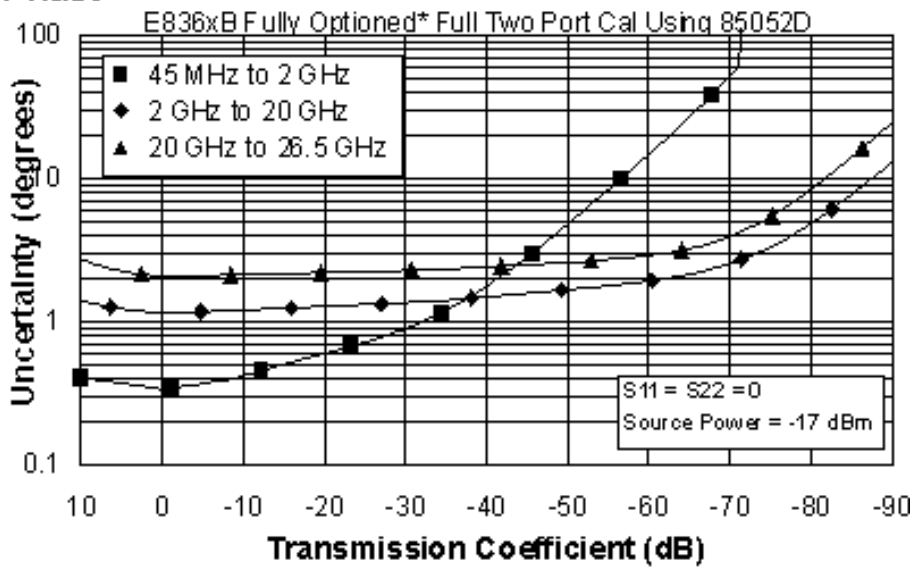

\* Configurable Test Set, Extended Power Range & Bias-Tees, Receiver Attenuators, Frequency Offset Mode, and Reference Channel Transfer Switch (E836xB/C - Option 014, UNL, 016, 080, and 081)

**Reflection Uncertainty (Specifications)**

**Magnitude**

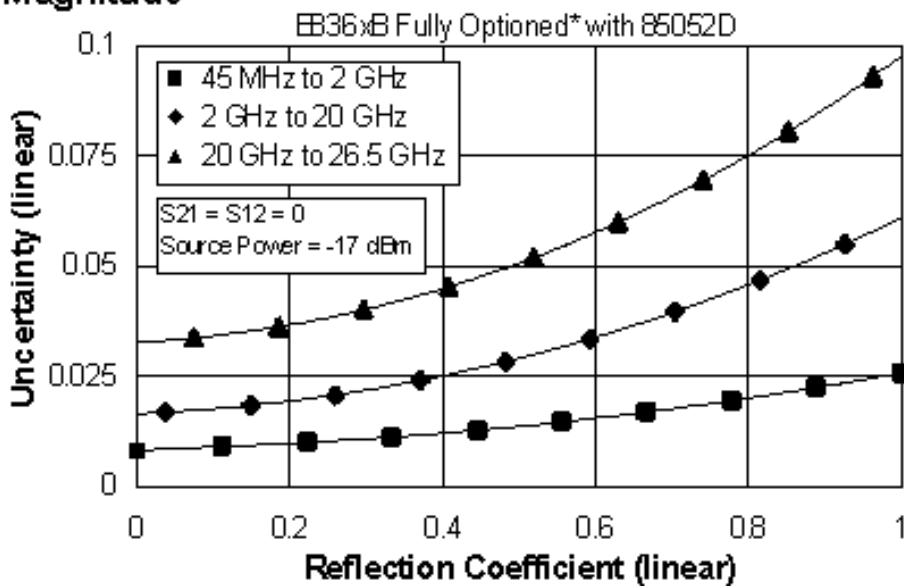

**Phase**

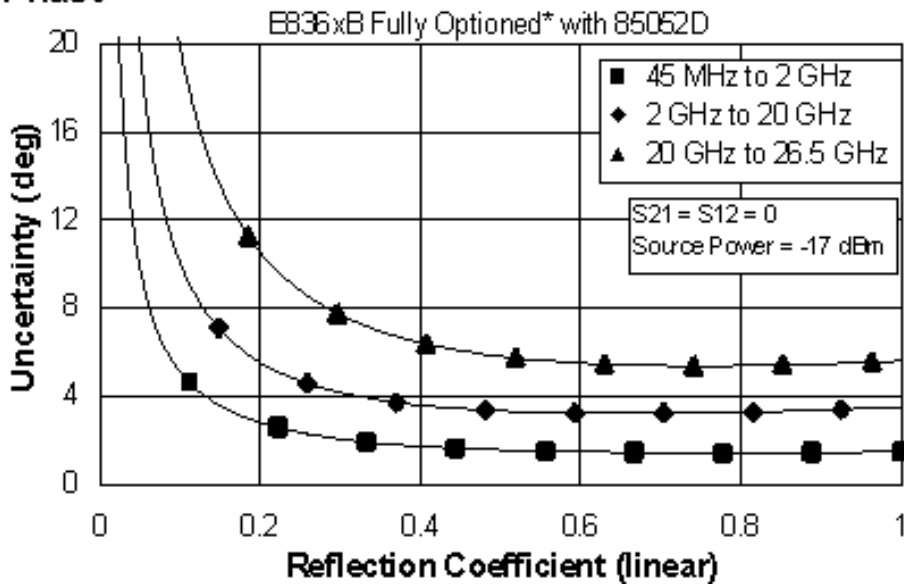

\* Configurable Test Set, Extended Power Range & Bias-Tees, Receiver Attenuators, Frequency Offset Mode, and Reference Channel Transfer Switch (E836xB/C - Option 014, UNL, 016, 080, and 081)



## E836xB/C Corrected System Performance with 7mm Connectors

**Table 15.** 85050B Calibration Kit  
Standard Configuration and Standard Power Range  
(E836xB/C)

Applies to the, E836xB/C analyzers, 85050B (7mm) calibration kit, 85132F flexible test port cable set, and a full 2-port calibration. Also applies to the following condition:

Environmental temperature  $23^{\circ} \pm 3^{\circ} \text{C}$ , with  $< 1^{\circ} \text{C}$  deviation from calibration temperature

Description	Specification (dB)	
	0.045 to 2 GHz	2 to 18 GHz
Directivity	52	52
Source Match	48	41
Load Match	52	47
Reflection Tracking	$\pm 0.003$ $+0.02/^{\circ}\text{C}$	$\pm 0.047$ $+0.02/^{\circ}\text{C}$
Transmission Tracking	$\pm 0.004$ $+0.02/^{\circ}\text{C}$	$\pm 0.032$ $+0.02/^{\circ}\text{C}$

NOTE: The following graphs also apply to the “C” model of the analyzers.

**Transmission Uncertainty (Specifications)**

**Magnitude**

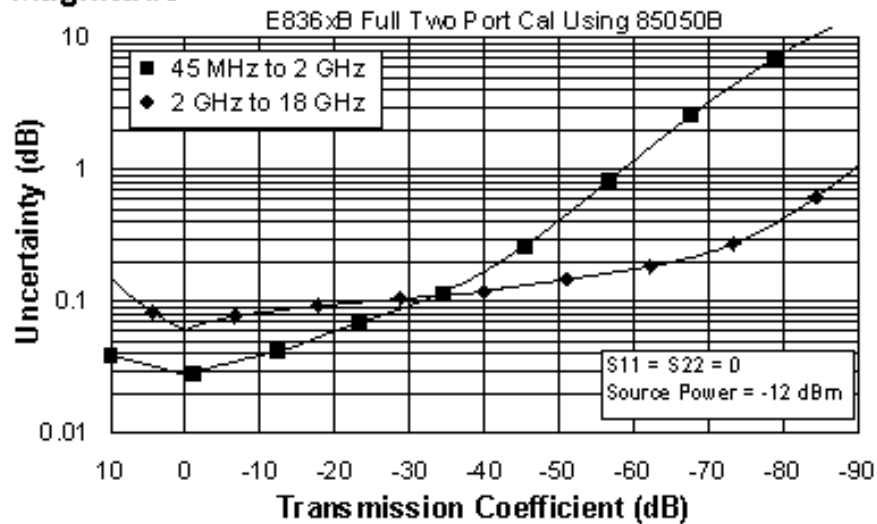

**Phase**

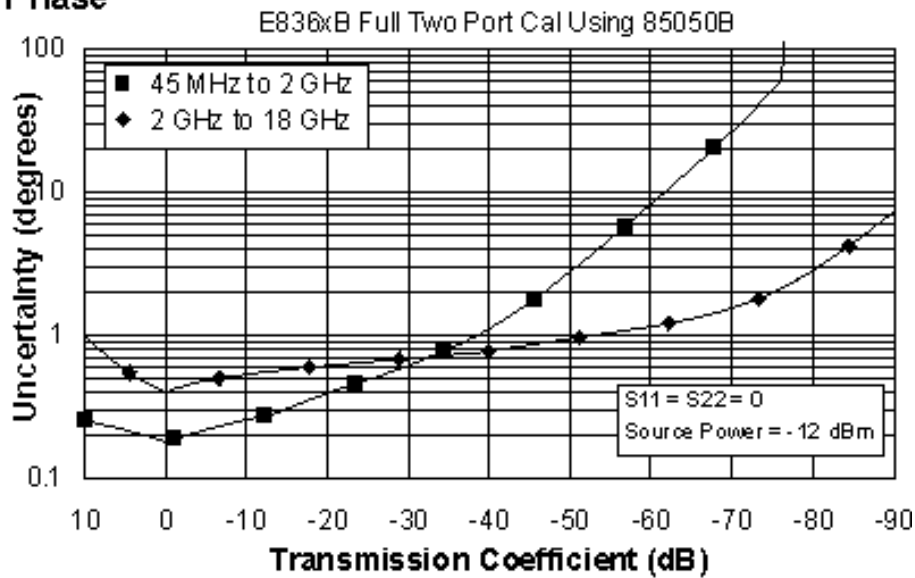

## Reflection Uncertainty (Specifications)

### Magnitude

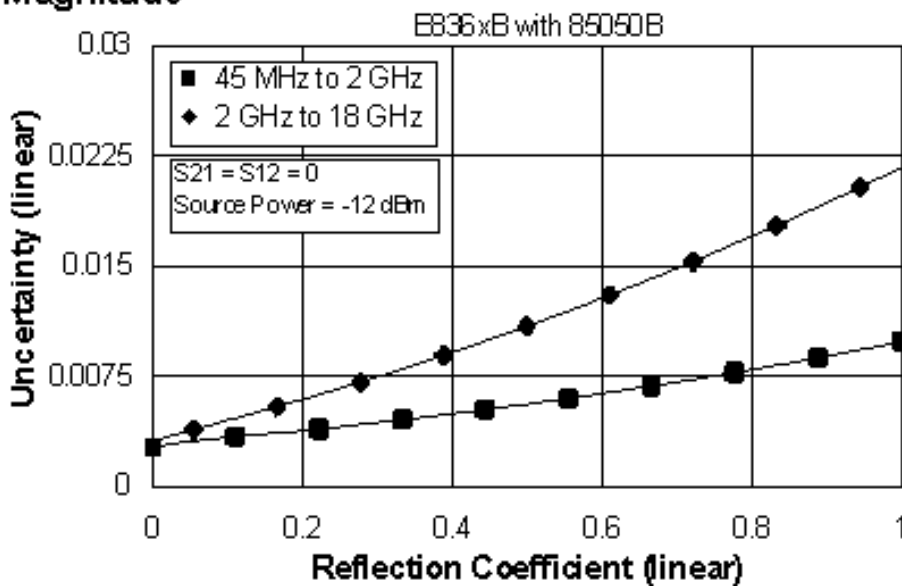

### Phase

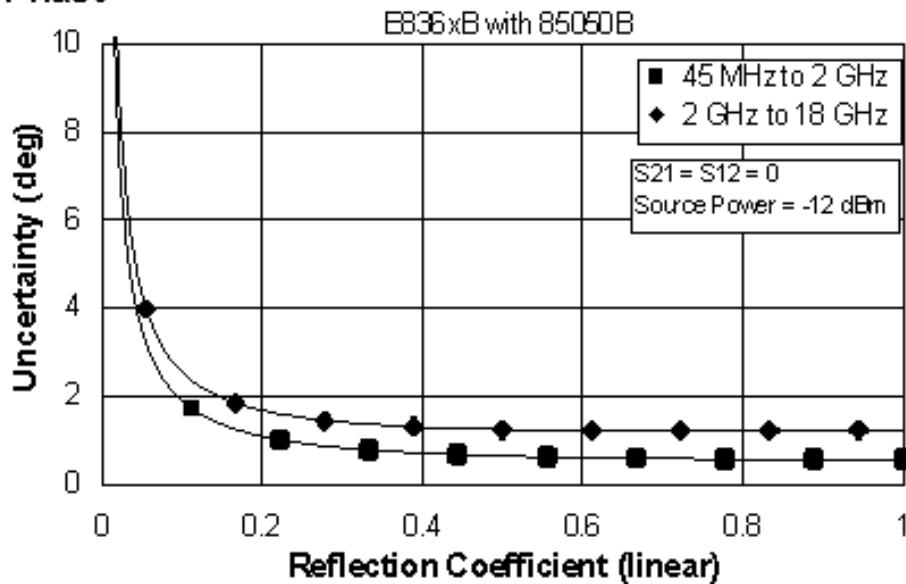

**Table 16. 85050B Calibration Kit**

Fully Optioned (E836xB/C - Option 014, UNL, 016, 080, and 081)

Configurable Test Set, Extended Power Range &amp; Bias-Tees, Receiver Attenuators, Frequency Offset Mode, and Reference Channel Transfer Switch

Applies to the, E836xB/C analyzers, 85050B (7mm) calibration kit, 85132F flexible test port cable set, and a full 2-port calibration. Also applies to the following condition:

Environmental temperature 23° ±3 °C, with &lt; 1 °C deviation from calibration temperature

Description	Specification (dB)	
	0.045 to 2 GHz	2 to 18 GHz
Directivity	52	52
Source Match	48	41
Load Match	52	47
Reflection Tracking	±0.003 +0.02/°C	±0.047 +0.02/°C
Transmission Tracking	±0.008 +0.02/°C	±0.034 +0.02/°C

NOTE: The following graphs also apply to the “C” model of the analyzers.

**Transmission Uncertainty (Specifications)**

**Magnitude**

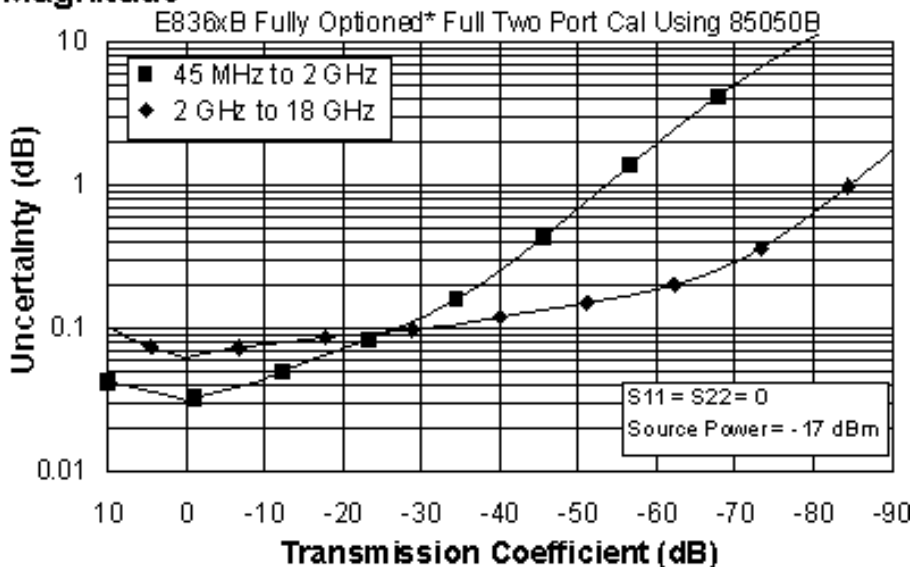

**Phase**

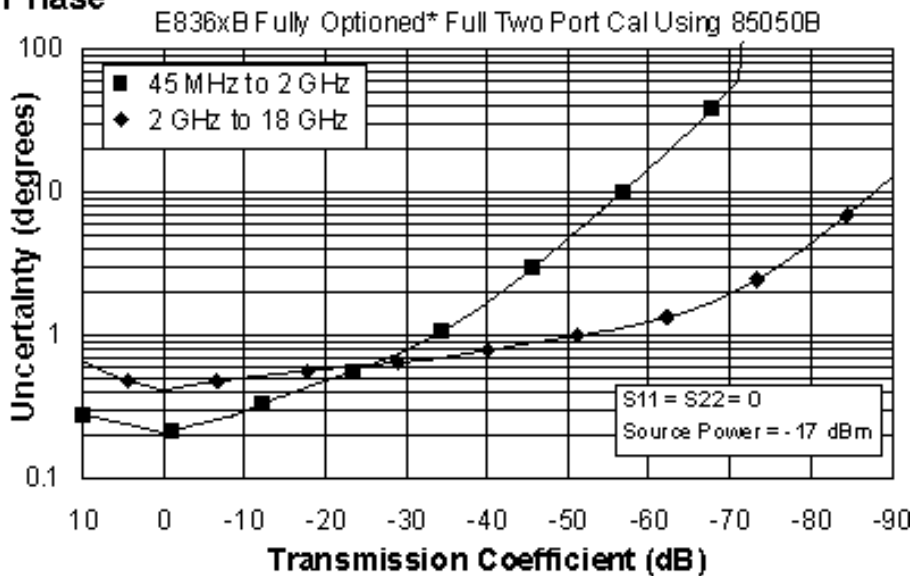

\*Configurable Test Set, Extended Power Range & Bias-Tees, Receiver Attenuators, Frequency Offset Mode, and Reference Channel Transfer Switch (E836xB/C - Option 014, UNL, 016, 080, and 081)

**Reflection Uncertainty (Specifications)**

**Magnitude**

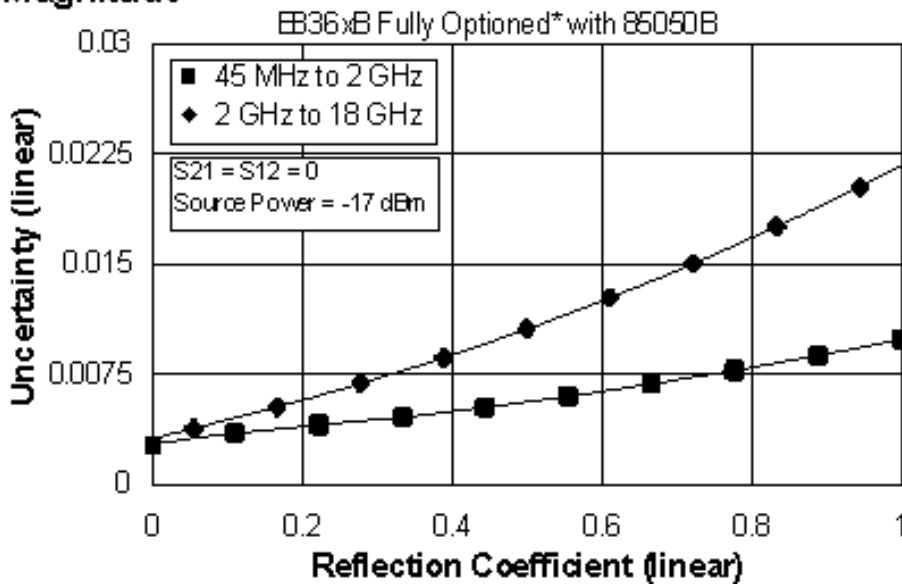

**Phase**

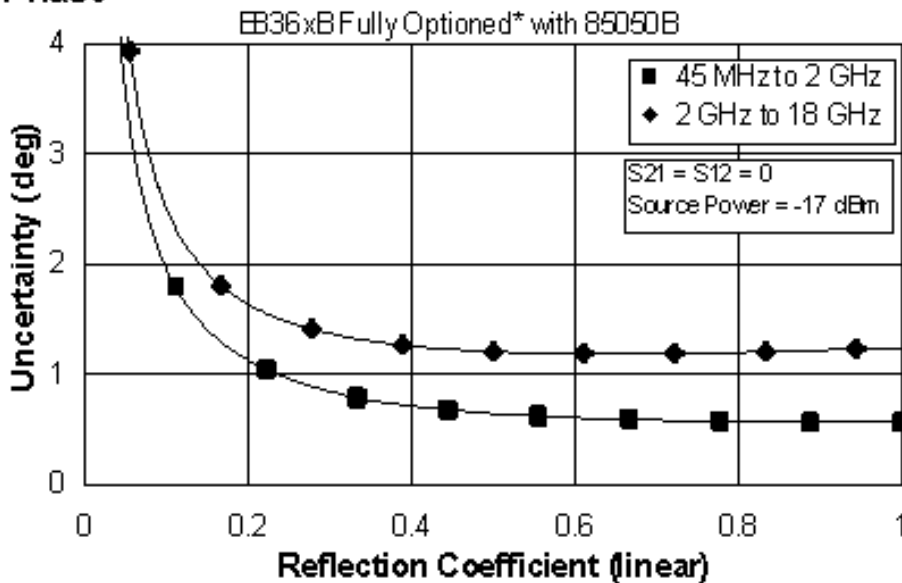

\*Configurable Test Set, Extended Power Range & Bias-Tees, Receiver Attenuators, Frequency Offset Mode, and Reference Channel Transfer Switch (E836xB/C - Option 014, UNL, 016, 080, and 081)

**Table 17. 85050C Calibration Kit**  
**Standard Configuration and Standard Power Range**  
**(E836xB/C)**

Applies to the, E836xB/C analyzers, 85050C (7mm) calibration kit, 85132F flexible test port cable set, and a full 2-port calibration. Also applies to the following condition:

Environmental temperature 23° ±3 °C, with < 1 °C deviation from calibration temperature

Description	Specification (dB)	
	0.045 to 2 GHz	2 to 18 GHz
Directivity	52	60
Source Match	48	60
Load Match	52	60
Reflection Tracking	±0.003 +0.02/°C	±0.000 +0.02/°C
Transmission Tracking	±0.004 +0.02/°C	±0.004 +0.02/°C

NOTE: The following graphs also apply to the "C" model of the analyzers.

**Transmission Uncertainty (Specifications)**

**Magnitude**

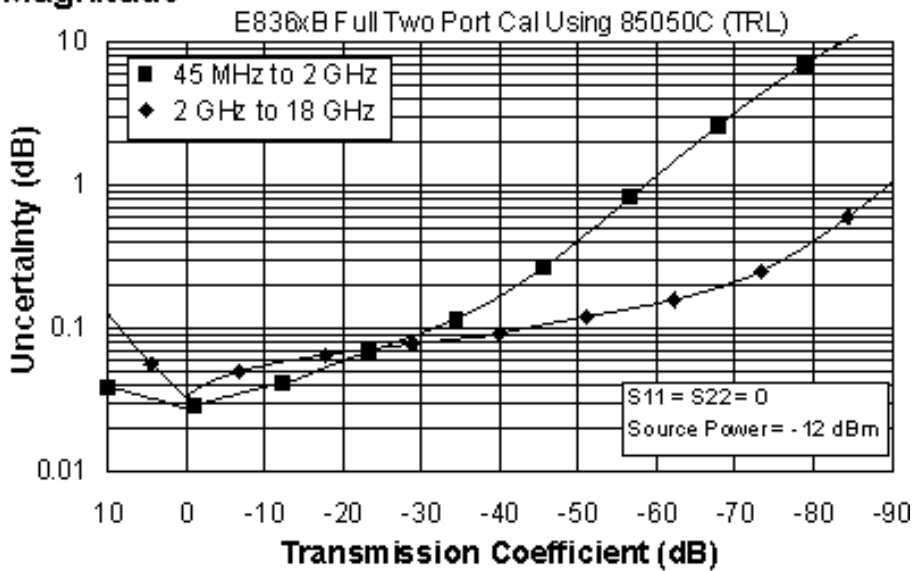

**Phase**

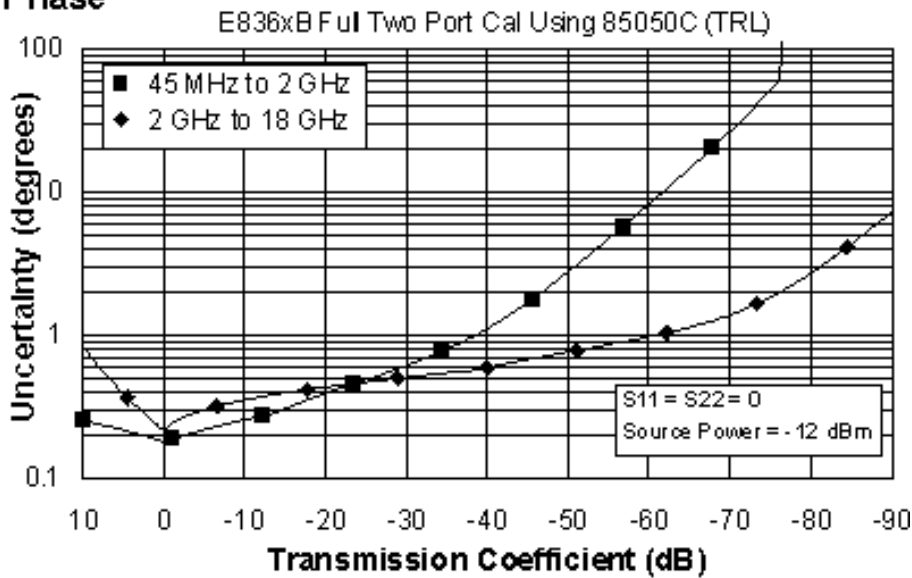



## Reflection Uncertainty (Specifications)

### Magnitude

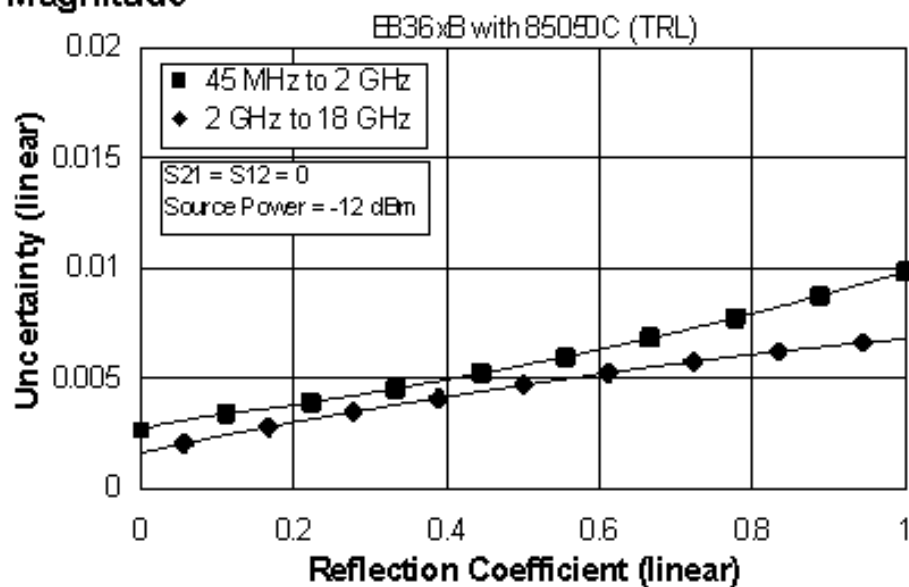

### Phase

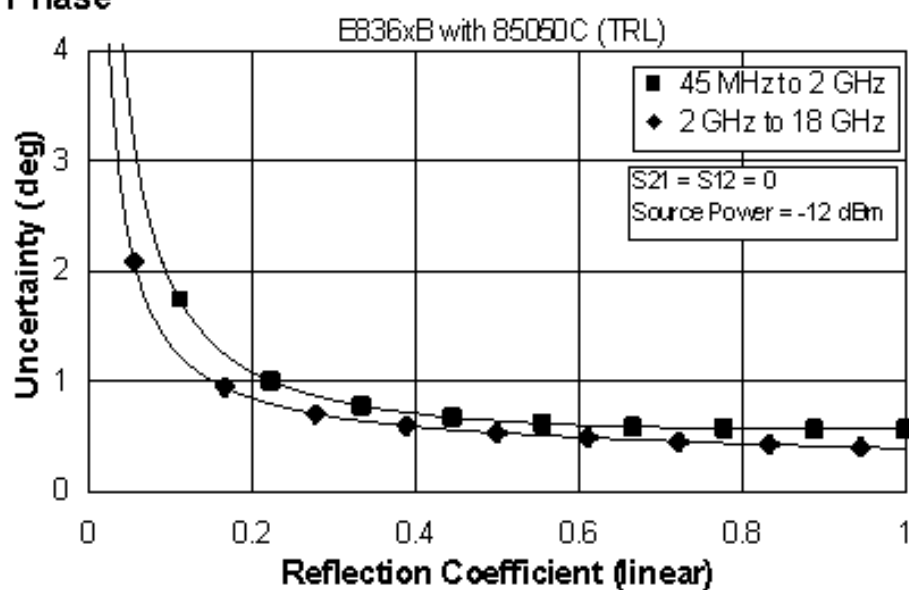

**Table 18. 85050C Calibration Kit**  
**Fully Optioned (E836xB/C - Option 014, UNL, 016, 080, and 081)**

Configurable Test Set, Extended Power Range & Bias-Tees, Receiver Attenuators, Frequency Offset Mode, and Reference Channel Transfer Switch

Applies to the, E836xB/C analyzers, 85050C (7mm) calibration kit, 85132F flexible test port cable set, and a full 2-port calibration. Also applies to the following condition:

Environmental temperature 23° ±3 °C, with < 1 °C deviation from calibration temperature

Description	Specification (dB)	
	0.045 to 2 GHz	2 to 18 GHz
Directivity	52	60
Source Match	48	60
Load Match	52	60
Reflection Tracking	±0.003 +0.02/°C	±0.000 +0.02/°C
Transmission Tracking	±0.008 +0.02/°C	±0.005 +0.02/°C

NOTE: The following graphs also apply to the “C” model of the analyzers.

**Transmission Uncertainty (Specifications)**

**Magnitude**

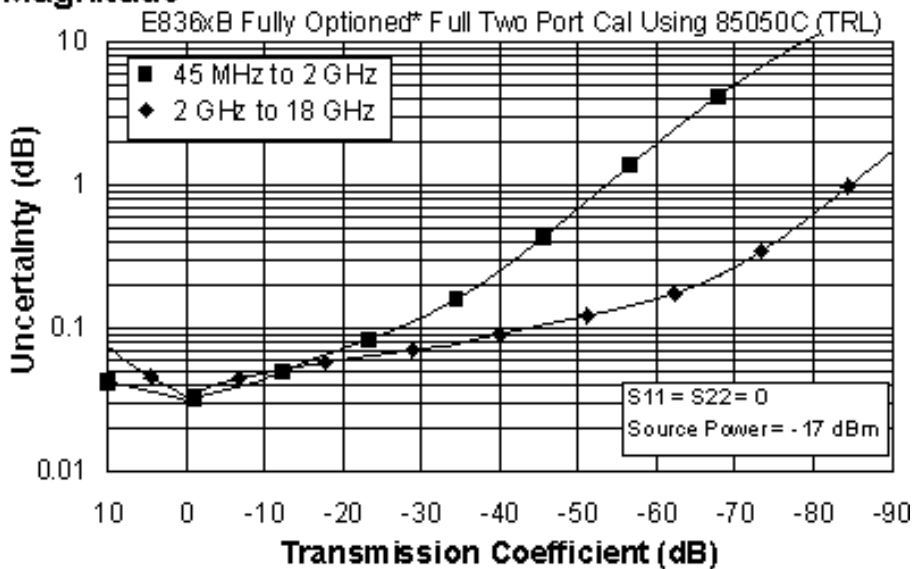

**Phase**

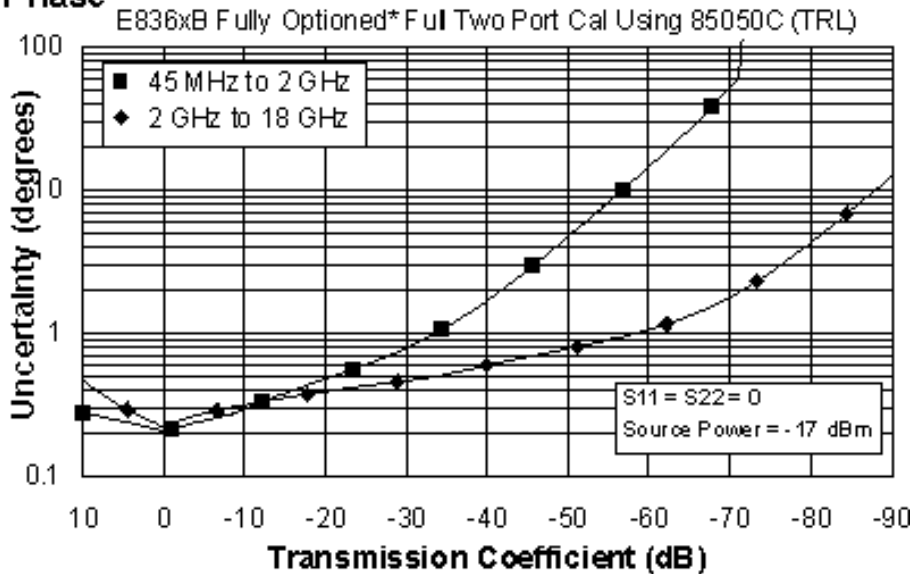

\*Configurable Test Set, Extended Power Range & Bias-Tees, Receiver Attenuators, Frequency Offset Mode, and Reference Channel Transfer Switch (E836xB/C - Option 014, UNL, 016, 080, and 081)

**Reflection Uncertainty (Specifications)**

**Magnitude**

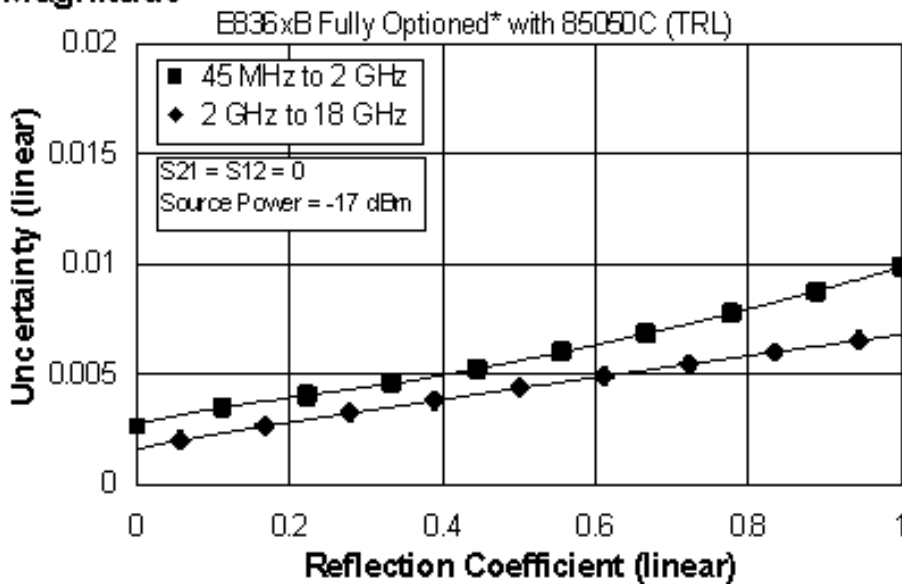

**Phase**

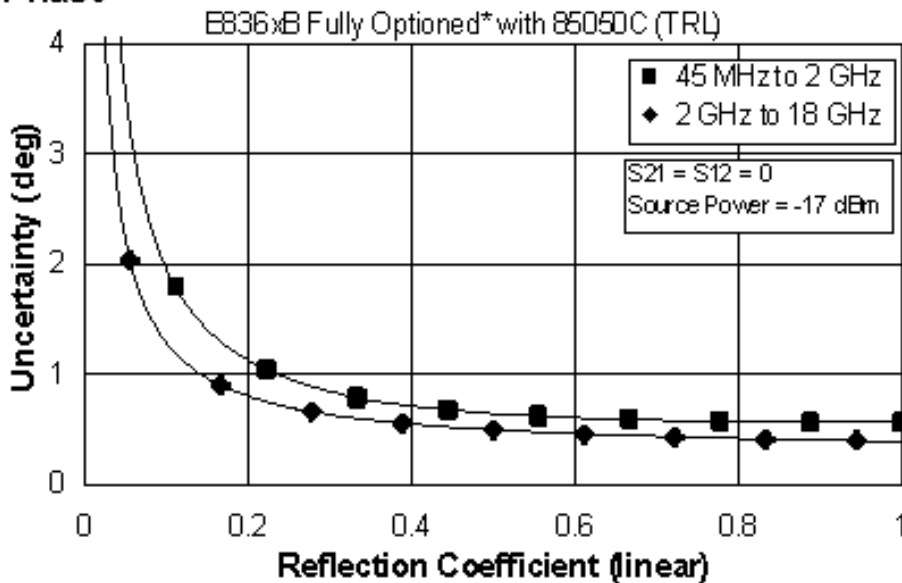

\*Configurable Test Set, Extended Power Range & Bias-Tees, Receiver Attenuators, Frequency Offset Mode, and Reference Channel Transfer Switch (E836xB/C - Option 014, UNL, 016, 080, and 081)

**Table 19. 85050D Calibration Kit**  
**Standard Configuration and Standard Power Range**  
**(E836xB/C)**

Applies to the, E836xB/C analyzers, 85050D (7mm) calibration kit, 85132F flexible test port cable set, and a full 2-port calibration. Also applies to the following condition:

Environmental temperature  $23^{\circ} \pm 3^{\circ} \text{C}$ , with  $< 1^{\circ} \text{C}$  deviation from calibration temperature

Description	Specification (dB)	
	0.045 to 2 GHz	2 to 18 GHz
Directivity	40	40
Source Match	39	35
Load Match	40	37
Reflection Tracking	$\pm 0.010$ $+0.02/^{\circ}\text{C}$	$\pm 0.100$ $+0.02/^{\circ}\text{C}$
Transmission Tracking	$\pm 0.013$ $+0.02/^{\circ}\text{C}$	$\pm 0.072$ $+0.02/^{\circ}\text{C}$

NOTE: The following graphs also apply to the “C” model of the analyzers.

**Transmission Uncertainty (Specifications)**

**Magnitude**

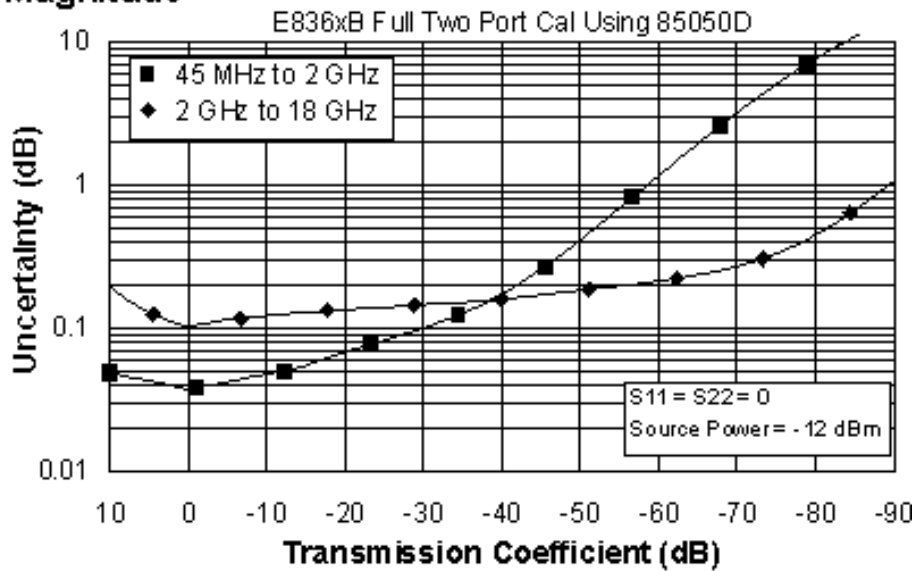

**Phase**

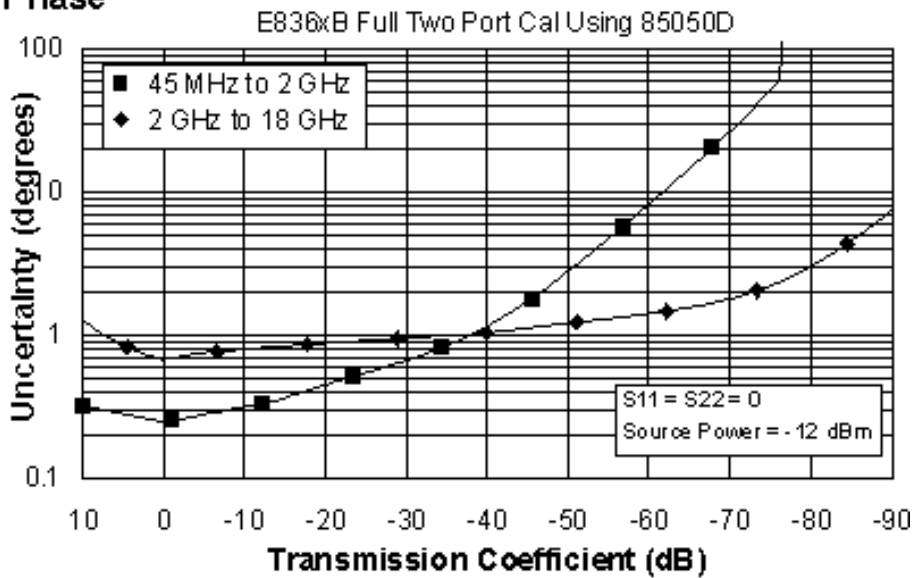

## Reflection Uncertainty (Specifications)

### Magnitude

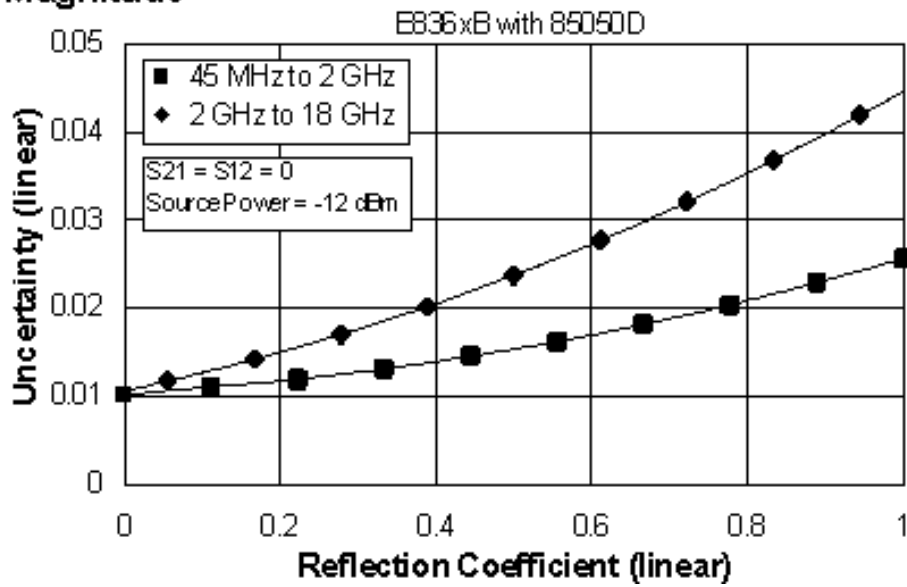

### Phase

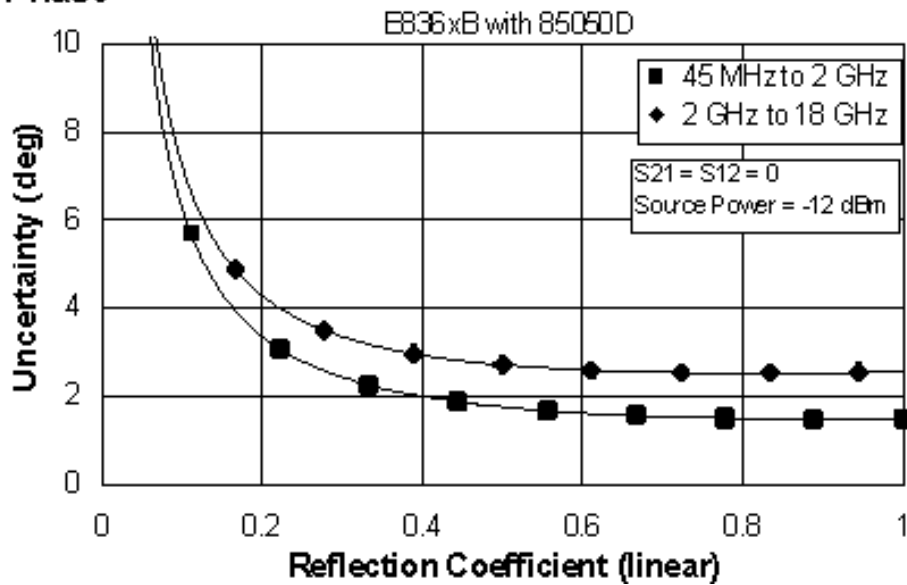

**Table 20. 85050D Calibration Kit**  
**Fully Optioned (E836xB/C - Option 014, UNL, 016, 080, and 081)**

Configurable Test Set, Extended Power Range & Bias-Tees, Receiver Attenuators, Frequency Offset Mode, and Reference Channel Transfer Switch

Applies to the, E836xB/C analyzers, 85050D (7mm) calibration kit, 85132F flexible test port cable set, and a full 2-port calibration. Also applies to the following condition:

Environmental temperature 23° ±3 °C, with < 1 °C deviation from calibration temperature

Description	Specification (dB)	
	0.045 to 2 GHz	2 to 18 GHz
Directivity	40	40
Source Match	39	35
Load Match	40	37
Reflection Tracking	±0.010 +0.02/°C	±0.100 +0.02/°C
Transmission Tracking	±0.025 +0.02/°C	±0.078 +0.02/°C



NOTE: The following graphs also apply to the “C” model of the analyzers.

**Transmission Uncertainty (Specifications)**

**Magnitude**

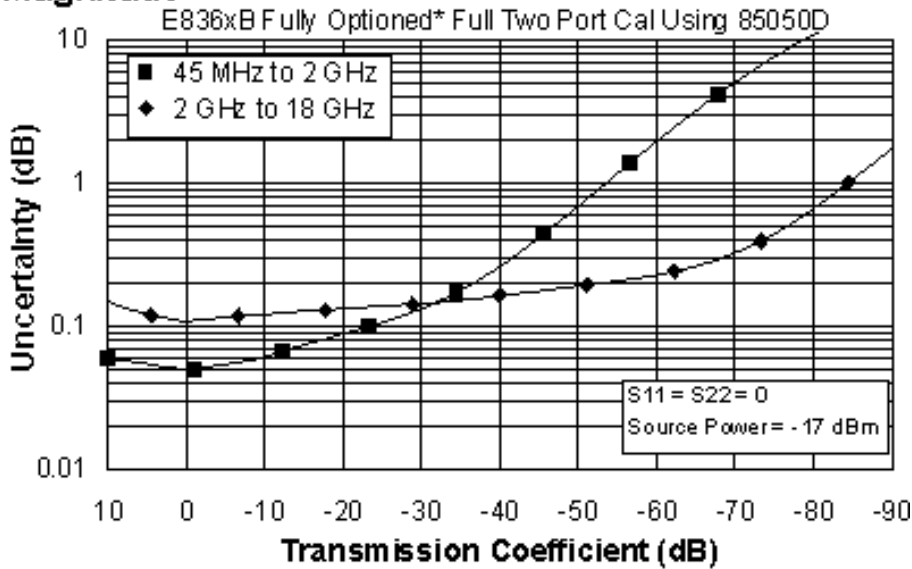

**Phase**

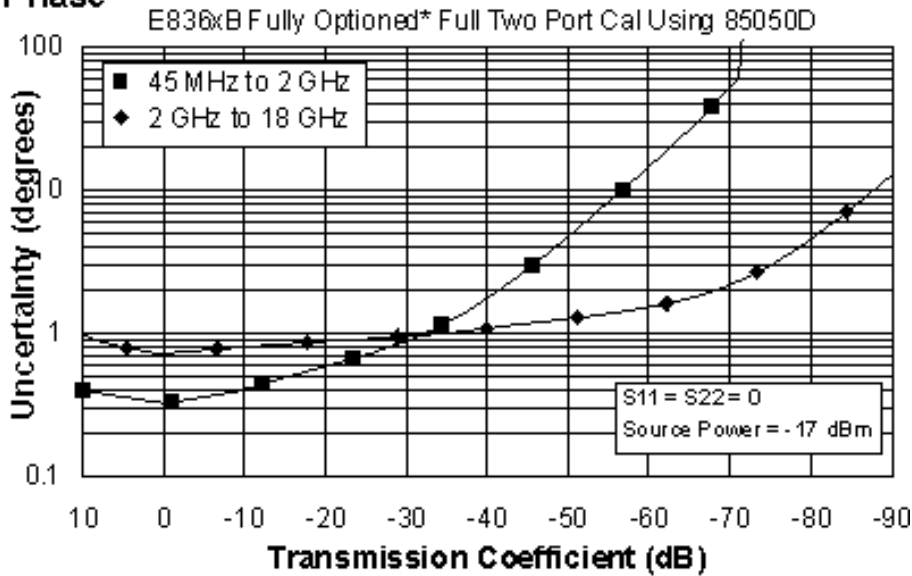

\*Configurable Test Set, Extended Power Range & Bias-Tees, Receiver Attenuators, Frequency Offset Mode, and Reference Channel Transfer Switch (E836xB/C - Option 014, UNL, 016, 080, and 081)

**Reflection Uncertainty (Specifications)**

**Magnitude**

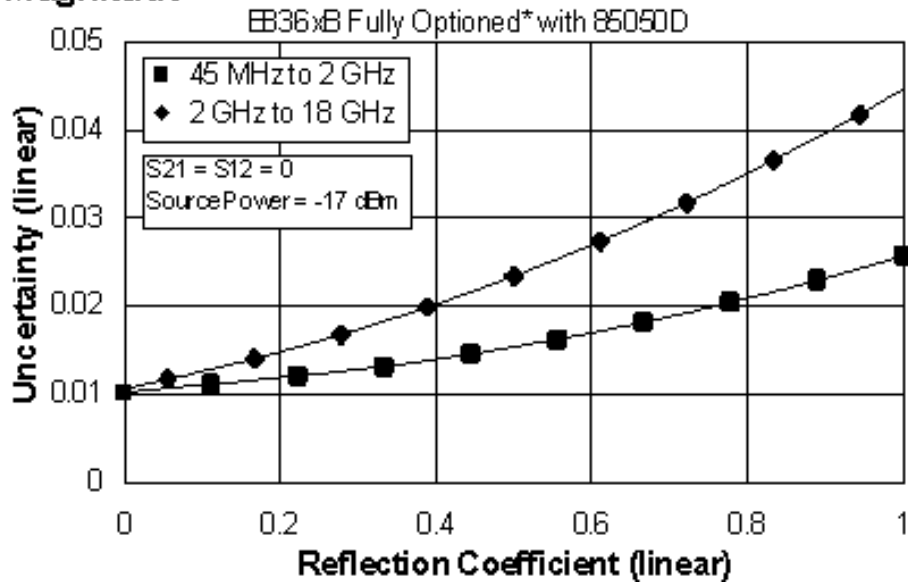

**Phase**

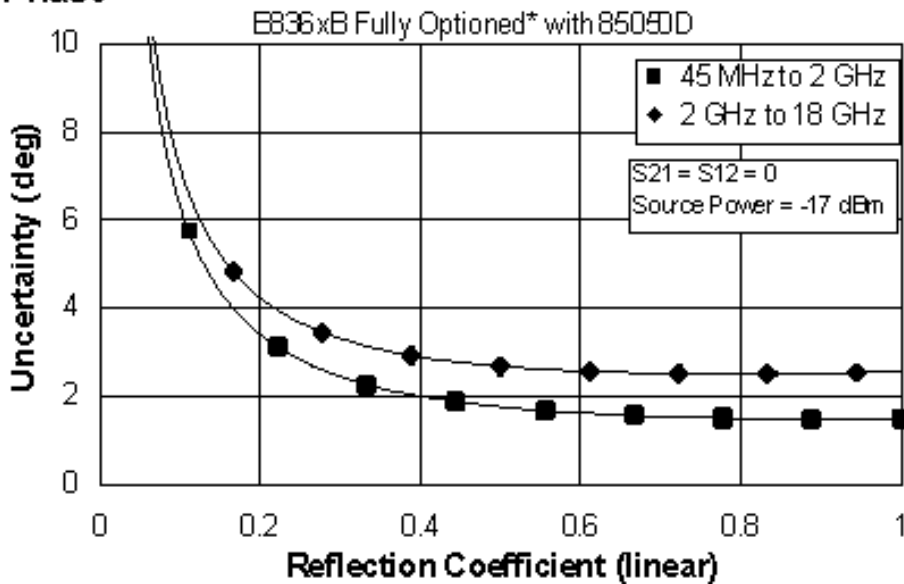

\*Configurable Test Set, Extended Power Range & Bias-Tees, Receiver Attenuators, Frequency Offset Mode, and Reference Channel Transfer Switch (E836xB/C - Option 014, UNL, 016, 080, and 081)

**E836xB/C Corrected System Performance with Type-N Connectors**

**Table 21. 85054B Calibration Kit**  
**Standard Configuration and Standard Power Range**  
 (E836xB/C)

Applies to the, E836xB/C analyzers, 85054B (Type-N) calibration kit, 85132F flexible test port cable set with 85130C adapter set, and a full 2-port calibration. Also applies to the following condition:

Environmental temperature 23° ±3 °C, with < 1 °C deviation from calibration temperature

Description	Specification (dB)	
	0.045 to 2 GHz	2 to 18 GHz
Directivity	48	42
Source Match	45	33
Load Match	48	41
Reflection Tracking	±0.001 +0.02/°C	±0.015 +0.02/°C
Transmission Tracking	±0.006 +0.02/°C	±0.079 +0.02/°C

NOTE: The following graphs also apply to the "C" model of the analyzers.

Transmission Uncertainty (Specifications)

Magnitude

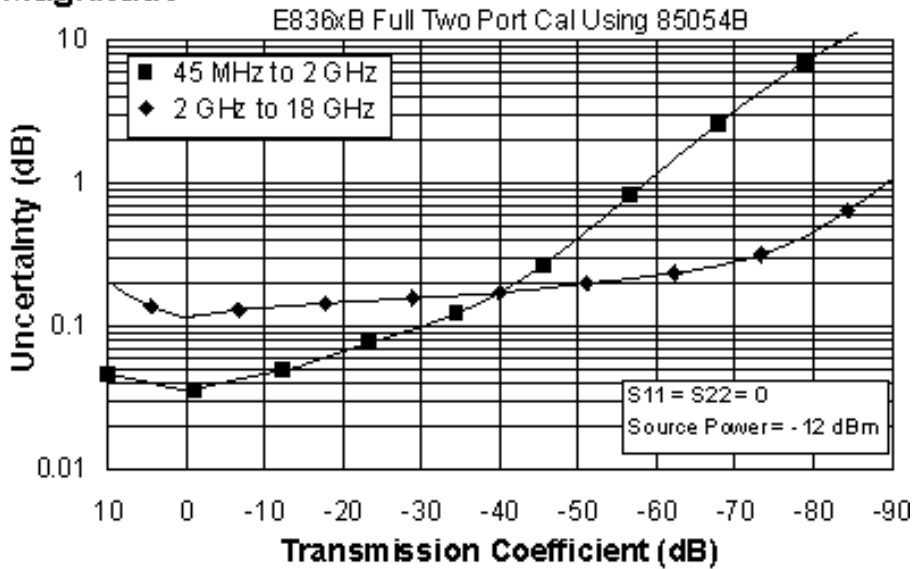

Phase

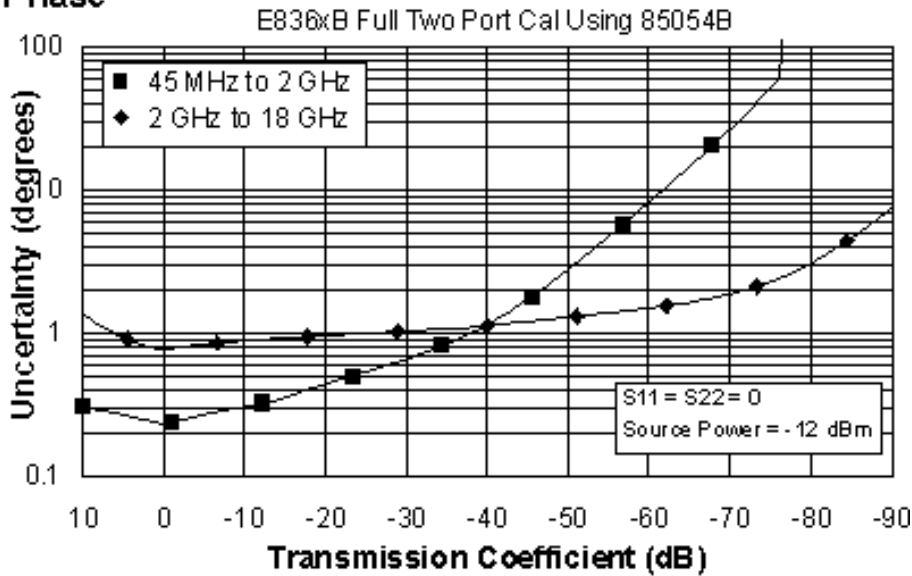

## Reflection Uncertainty (Specifications)

### Magnitude

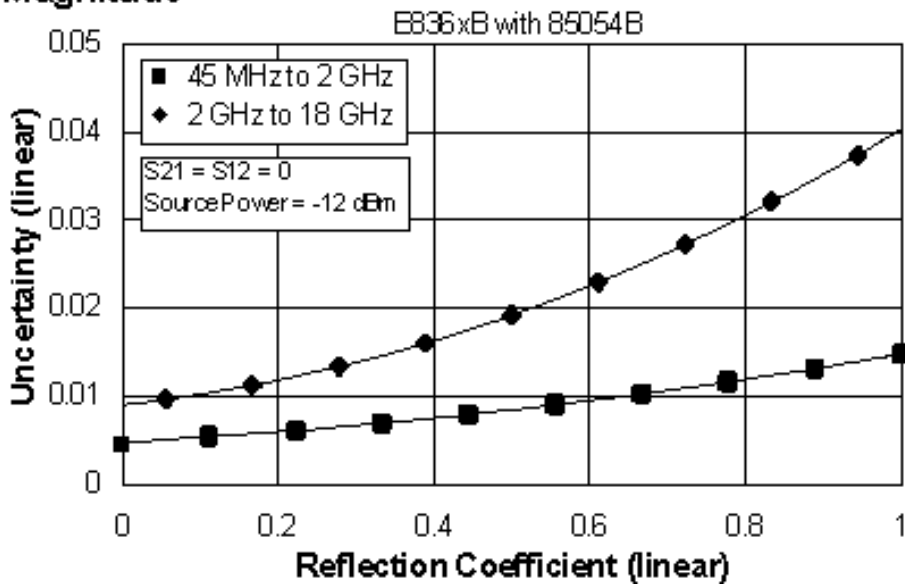

### Phase

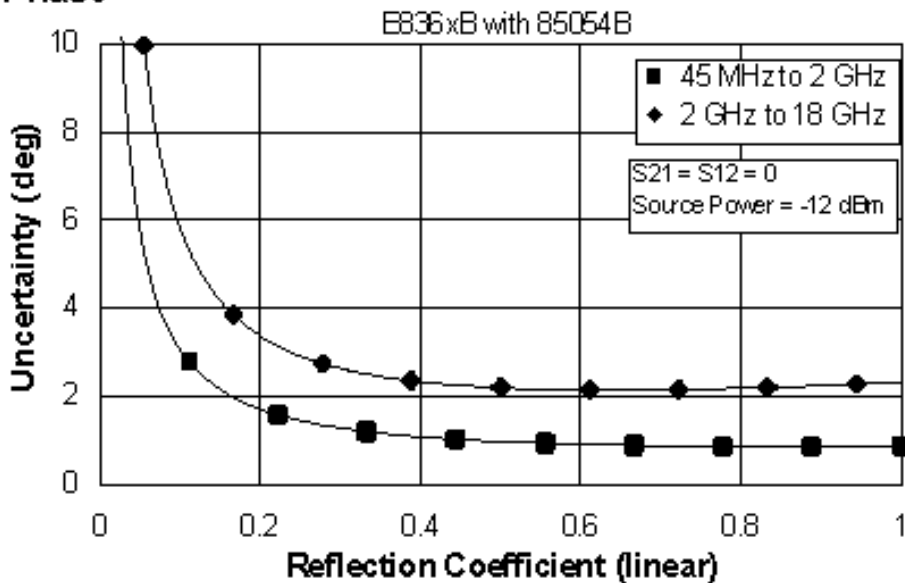

**Table 22. 85054B Calibration Kit**

Fully Optioned (E836xB/C - Option 014, UNL, 016, 080, and 081)

Configurable Test Set, Extended Power Range &amp; Bias-Tees, Receiver Attenuators, Frequency Offset Mode, and Reference Channel Transfer Switch

Applies to the, E836xB/C analyzers, 85054B (Type-N) calibration kit, 85132F flexible test port cable set with 85130C adapter set, and a full 2-port calibration. Also applies to the following condition:

Environmental temperature 23° ±3 °C, with &lt; 1 °C deviation from calibration temperature

Description	Specification (dB)	
	0.045 to 2 GHz	2 to 18 GHz
Directivity	48	42
Source Match	45	33
Load Match	48	41
Reflection Tracking	±0.001 +0.02/°C	±0.015 +0.02/°C
Transmission Tracking	±0.011 +0.02/°C	±0.083 +0.02/°C

NOTE: The following graphs also apply to the “C” model of the analyzers.

**Transmission Uncertainty (Specifications)**

**Magnitude**

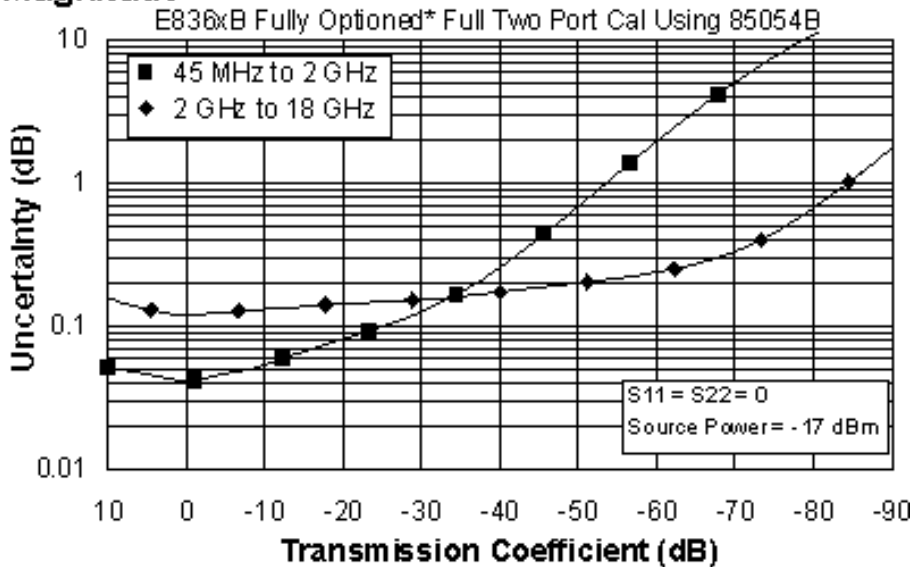

**Phase**

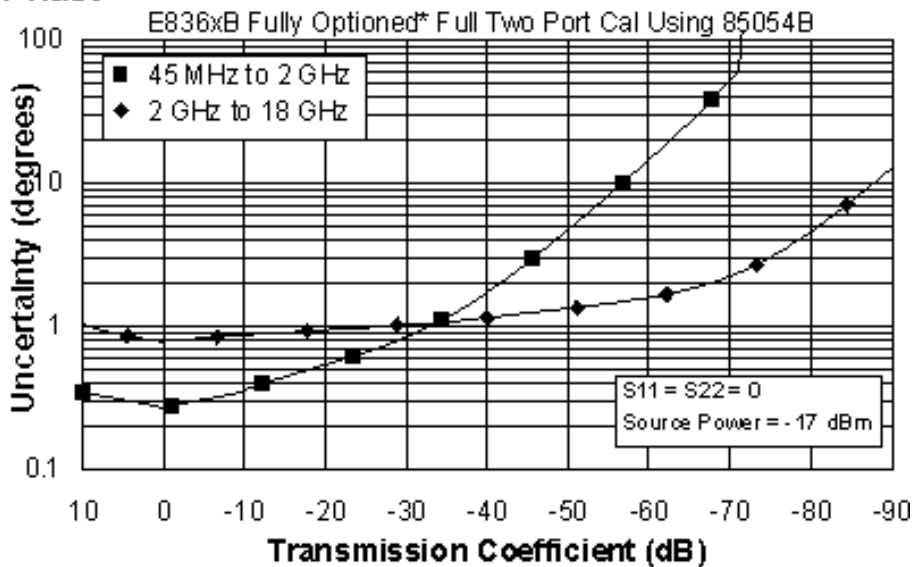

\* Configurable Test Set, Extended Power Range & Bias-Tees, Receiver Attenuators, Frequency Offset Mode, and Reference Channel Transfer Switch  
(E836xB/C - Option 014, UNL, 016, 080, and 081)

## Reflection Uncertainty (Specifications)

### Magnitude

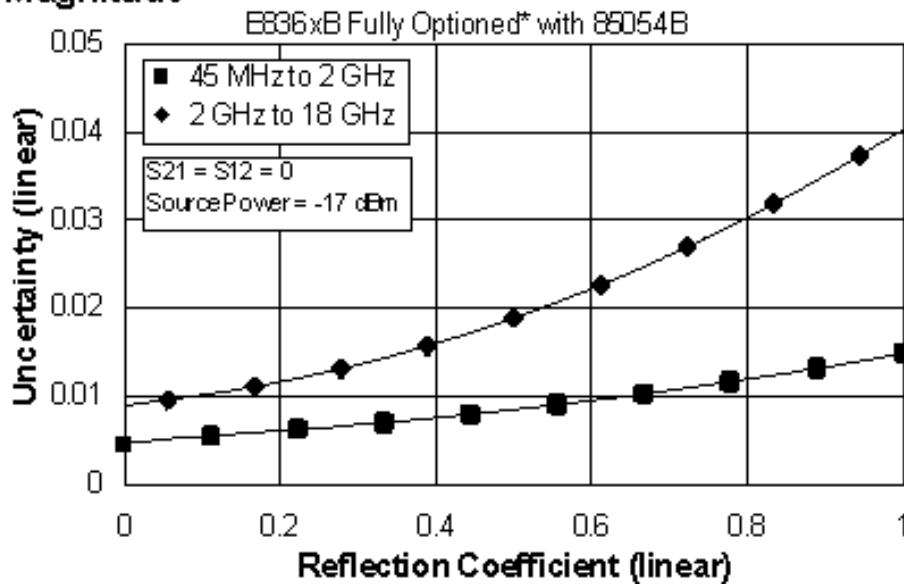

### Phase

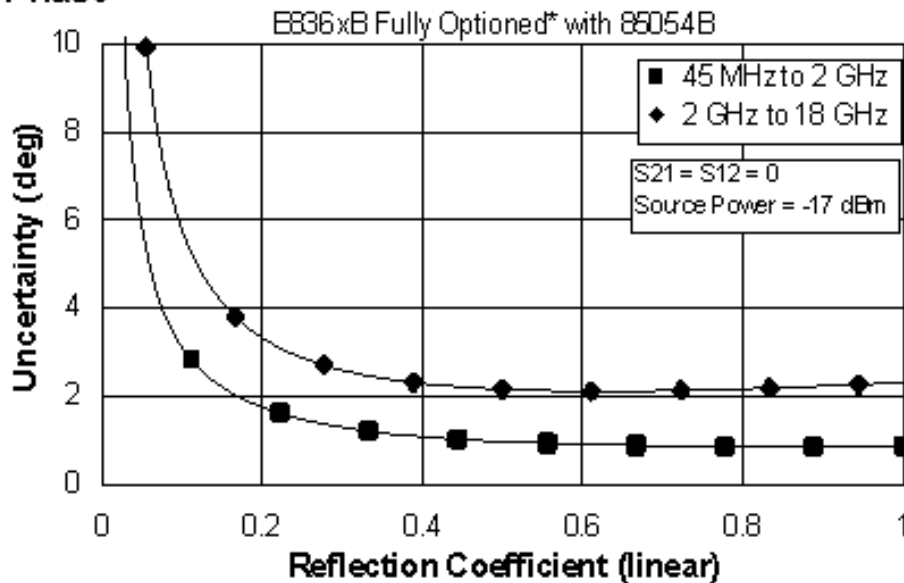

\* Configurable Test Set, Extended Power Range & Bias-Tees, Receiver Attenuators, Frequency Offset Mode, and Reference Channel Transfer Switch  
 (E836xB/C - Option 014, UNL, 016, 080, and 081)



**Table 23. 85054D Calibration Kit**  
**Standard Configuration and Standard Power Range**  
**(E836xB/C)**

Applies to the, E836xB/C analyzers, 85054D (Type-N) calibration kit, 85132F flexible test port cable set with 85130C adapter set, and a full 2-port calibration. Also applies to the following condition:

Environmental temperature  $23^{\circ} \pm 3^{\circ} \text{C}$ , with  $< 1^{\circ} \text{C}$  deviation from calibration temperature

Description	Specification (dB)	
	0.045 to 2 GHz	2 to 18 GHz
Directivity	40	34
Source Match	39	29
Load Match	40	34
Reflection Tracking	$\pm 0.003$ $+0.02/^{\circ}\text{C}$	$\pm 0.027$ $+0.02/^{\circ}\text{C}$
Transmission Tracking	$\pm 0.013$ $+0.02/^{\circ}\text{C}$	$\pm 0.136$ $+0.02/^{\circ}\text{C}$

NOTE: The following graphs also apply to the “C” model of the analyzers.

**Transmission Uncertainty (Specifications)**

**Magnitude**

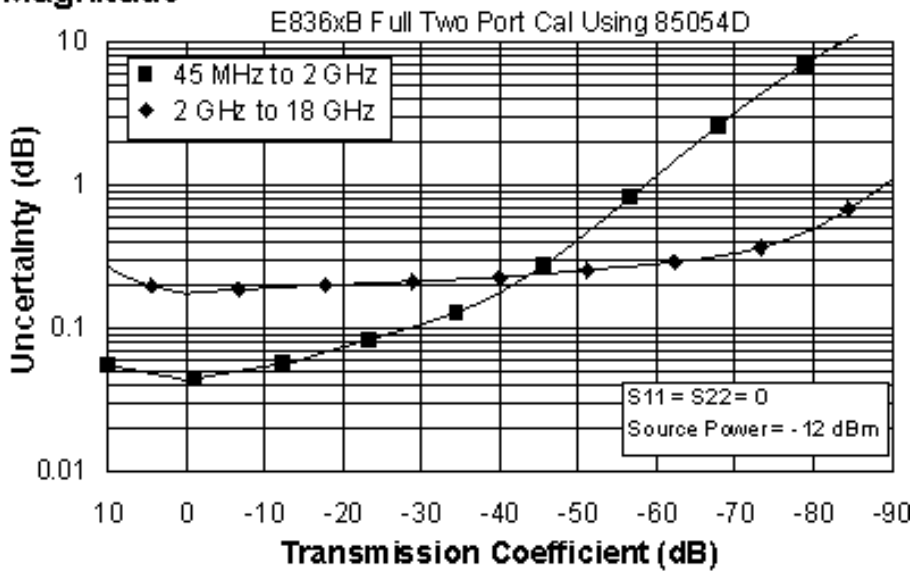

**Phase**

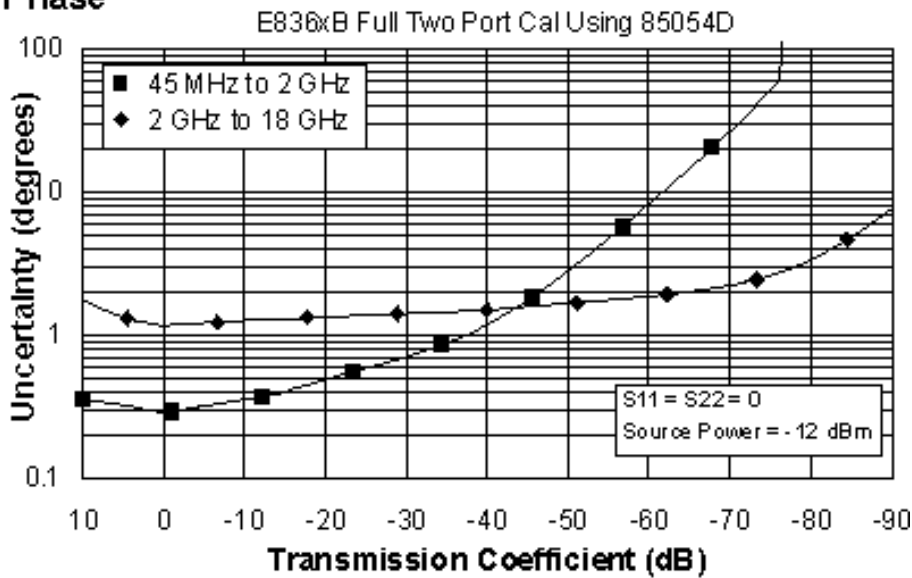

## Reflection Uncertainty (Specifications)

### Magnitude

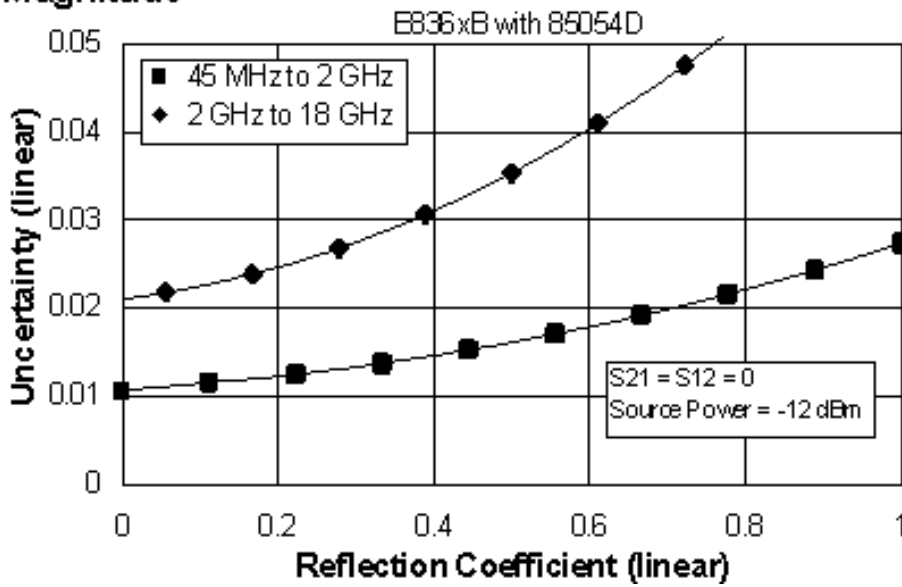

### Phase

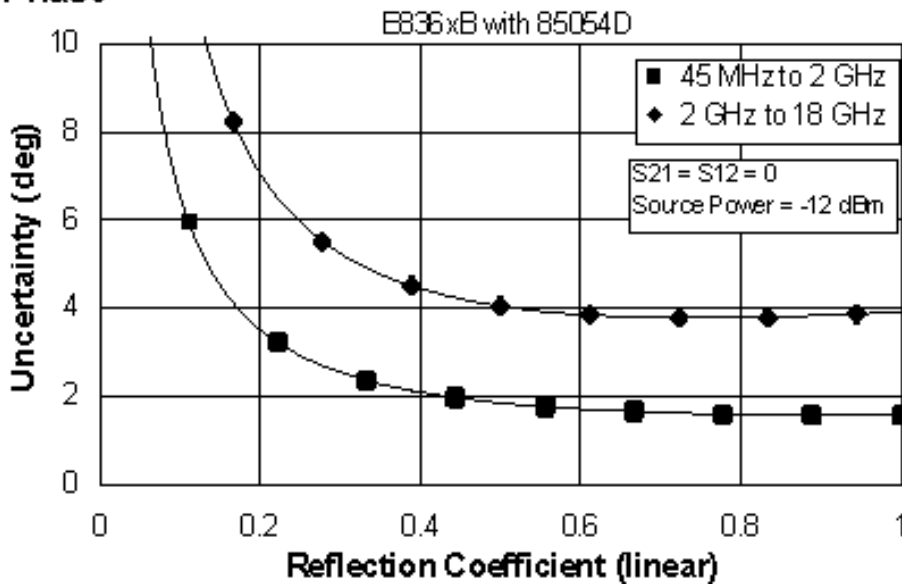

**Table 24. 85054D Calibration Kit****Fully Optioned (E836xB/C - Option 014, UNL, 016, 080, and 081)**

Configurable Test Set, Extended Power Range &amp; Bias-Tees, Receiver Attenuators, Frequency Offset Mode, and Reference Channel Transfer Switch

Applies to the, E836xB/C analyzers, 85054D (Type-N) calibration kit, 85132F flexible test port cable set with 85130C adapter set, and a full 2-port calibration. Also applies to the following condition:

Environmental temperature 23° ±3 °C, with &lt; 1 °C deviation from calibration temperature

<b>Description</b>	<b>Specification (dB)</b>	
	<b>0.045 to 2 GHz</b>	<b>2 to 18 GHz</b>
Directivity	40	34
Source Match	39	29
Load Match	40	34
Reflection Tracking	±0.003 +0.02/°C	±0.027 +0.02/°C
Transmission Tracking	±0.025 +0.02/°C	±0.145 +0.02/°C

NOTE: The following graphs also apply to the “C” model of the analyzers.

**Transmission Uncertainty (Specifications)**

**Magnitude**

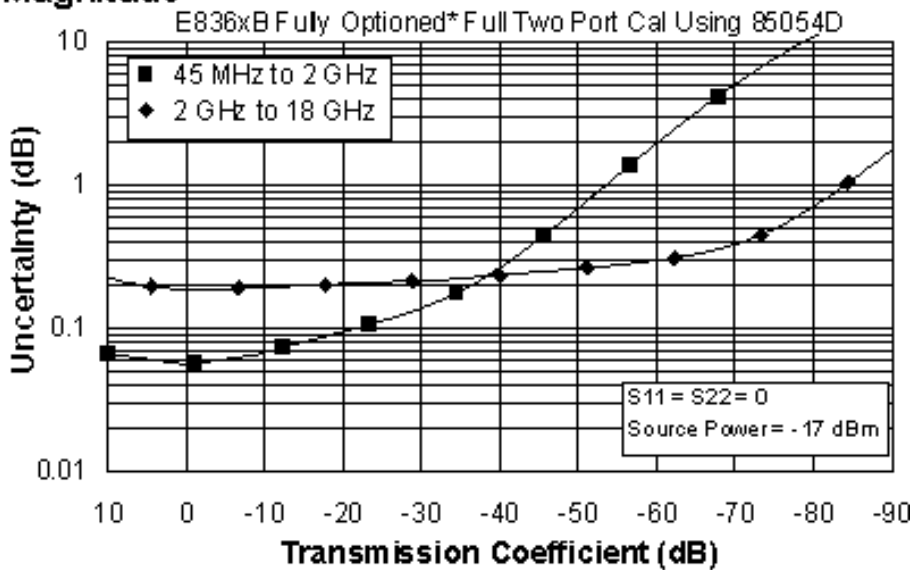

**Phase**

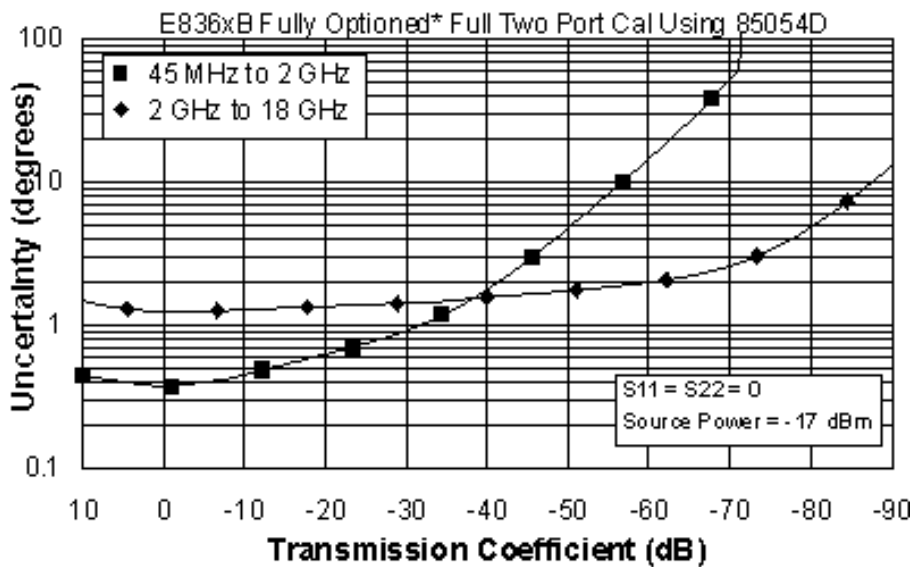

\* Configurable Test Set, Extended Power Range & Bias-Tees, Receiver Attenuators, Frequency Offset Mode, and Reference Channel Transfer Switch (E836xB/C - Option 014, UNL, 016, 080, and 081)

## Reflection Uncertainty (Specifications)

### Magnitude

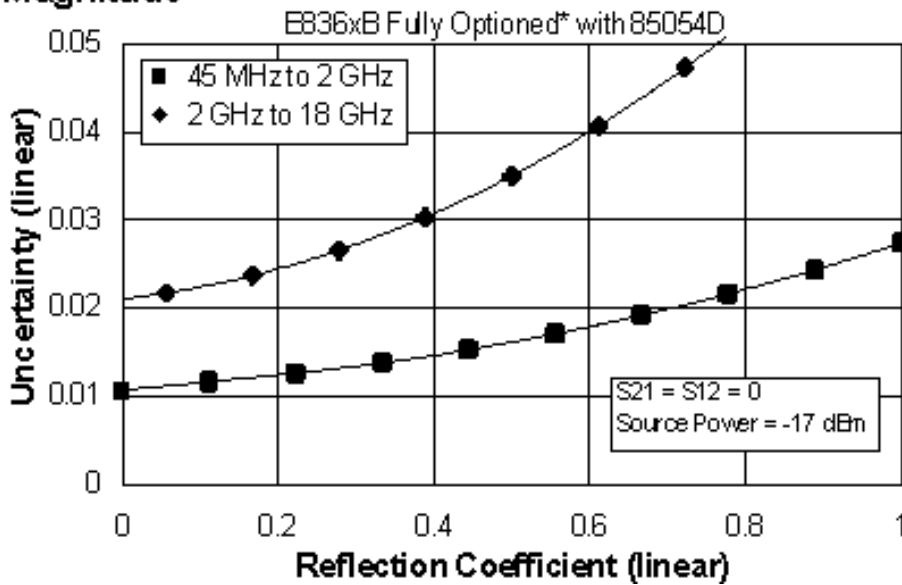

### Phase

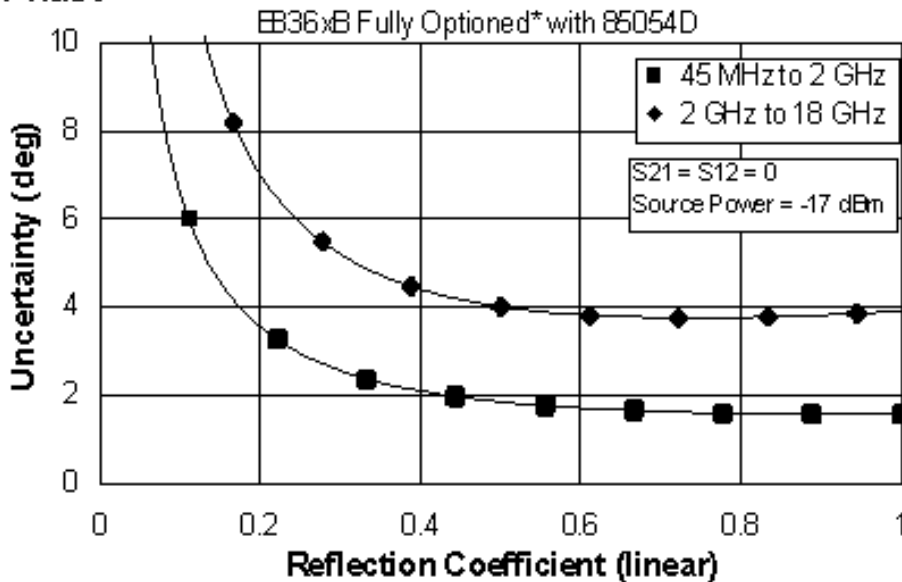

\* Configurable Test Set, Extended Power Range & Bias-Tees, Receiver Attenuators, Frequency Offset Mode, and Reference Channel Transfer Switch  
 (E836xB/C - Option 014, UNL, 016, 080, and 081)

**E8363B/C AND E8364B/C Corrected System Performance with WR-28 Connectors**

**Table 25. R11644A Calibration Kit**  
**Standard Configuration and Standard Power Range**  
**(E8363B/C AND E8364B/C)**

Applies to the, E8363B/C AND E8364B/C analyzers, R11644A (WR-28) calibration kit, 85133F flexible test port cable set with the R281A and R281B launch sets, and a full 2-port calibration. Also applies to the following condition:

Environmental temperature 23° ±3 °C, with < 1 °C deviation from calibration temperature

<b>Description</b>	<b>Specification (dB)</b>
	<b>26.5 to 40 GHz</b>
Directivity	50
Source Match	50
Load Match	50
Reflection Tracking	±0.000 +0.03/°C
Transmission Tracking	±0.018 +0.03/°C

NOTE: The following graphs also apply to the "C" model of the analyzers.

Transmission Uncertainty (Specifications)

Magnitude

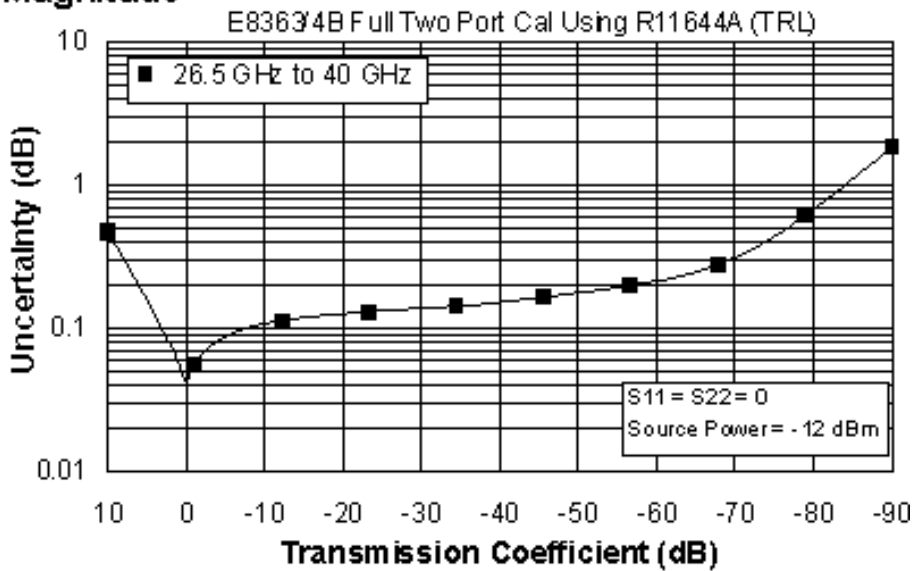

Phase

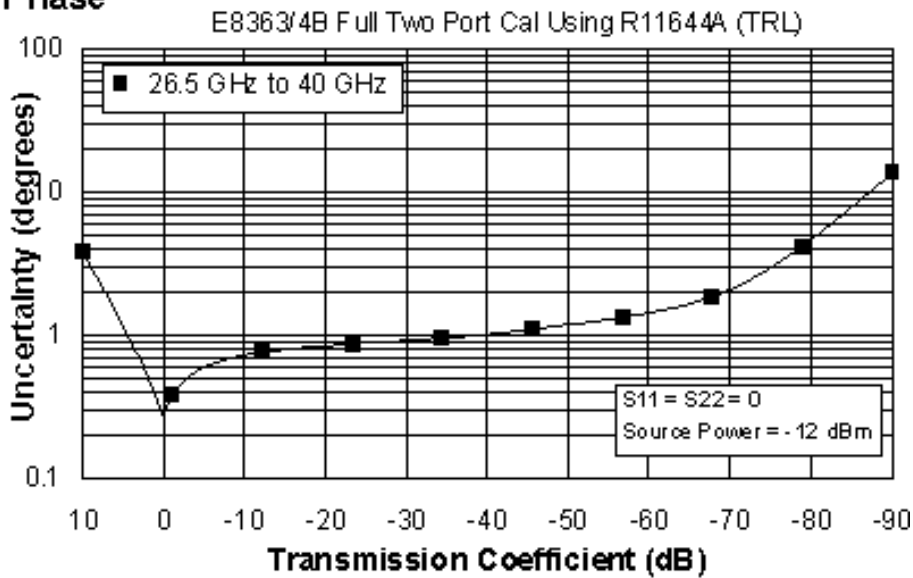



## Reflection Uncertainty (Specifications)

### Magnitude

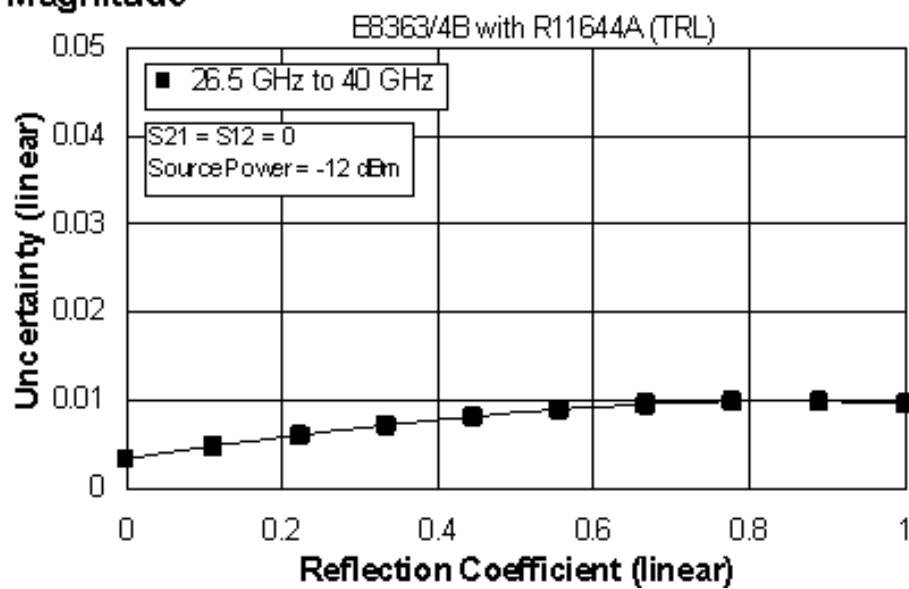

### Phase

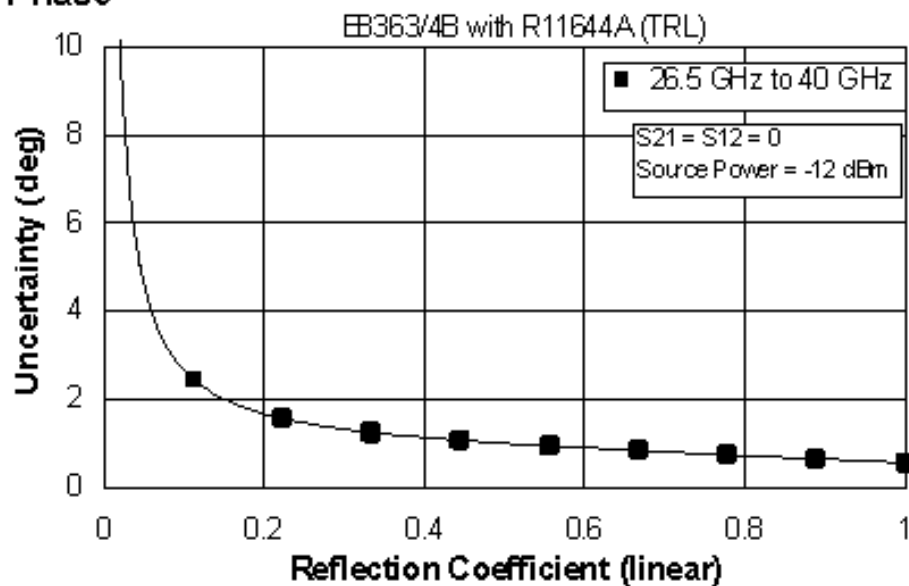

**Table 26. R11644A Calibration Kit**

Fully Optioned (E836xB/C - Option 014, UNL, 016, 080, and 081)

Configurable Test Set, Extended Power Range & Bias-Tees, Receiver Attenuators, Frequency Offset Mode, and Reference Channel Transfer Switch

Applies to the, E8363B/C AND E8364B/C analyzers, R11644A (WR-28) calibration kit, 85133F flexible test port cable set with the R281A and R281B launch sets, and a full 2-port calibration. Also applies to the following condition:

Environmental temperature 23° ±3 °C, with < 1 °C deviation from calibration temperature

Description	Specification (dB)
	<b>26.5 to 40 GHz</b>
Directivity	50
Source Match	50
Load Match	50
Reflection Tracking	±0.000
	+0.03/°C
Transmission Tracking	±0.019
	+0.03/°C

NOTE: The following graphs also apply to the “C” model of the analyzers.

**Transmission Uncertainty (Specifications)**

**Magnitude**

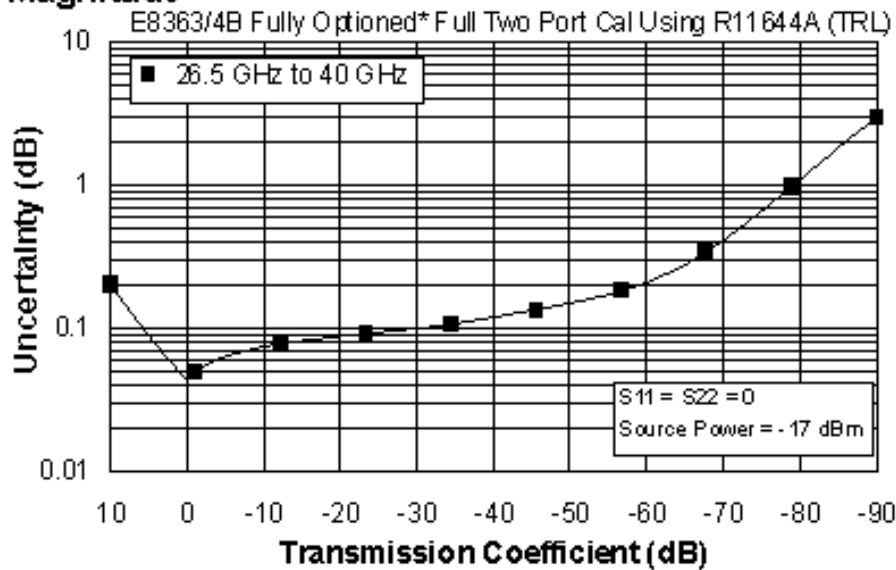

**Phase**

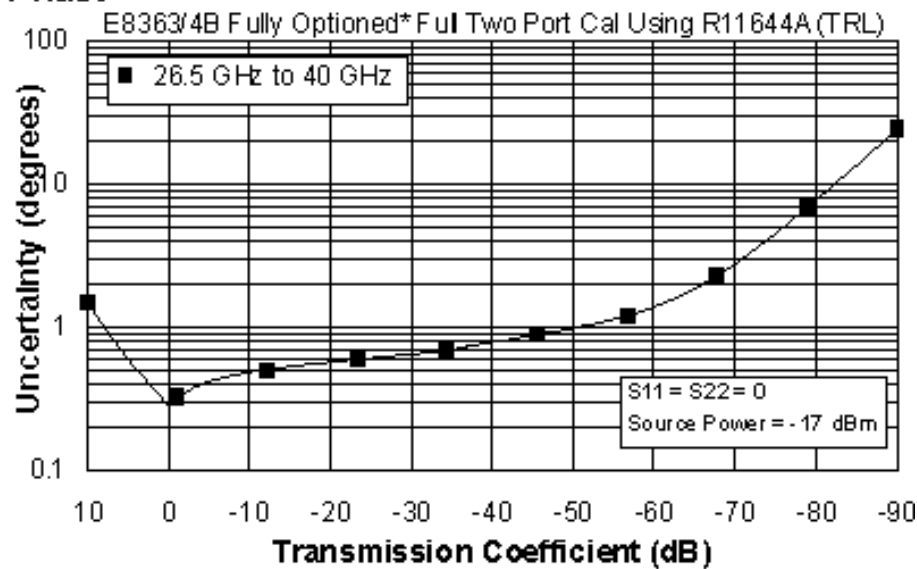

\* Configurable Test Set, Extended Power Range & Bias-Tees, Receiver Attenuators, Frequency Offset Mode, and Reference Channel Transfer Switch (E836xB/C - Option 014, UNL, 016, 080, and 081)

## Reflection Uncertainty (Specifications)

### Magnitude

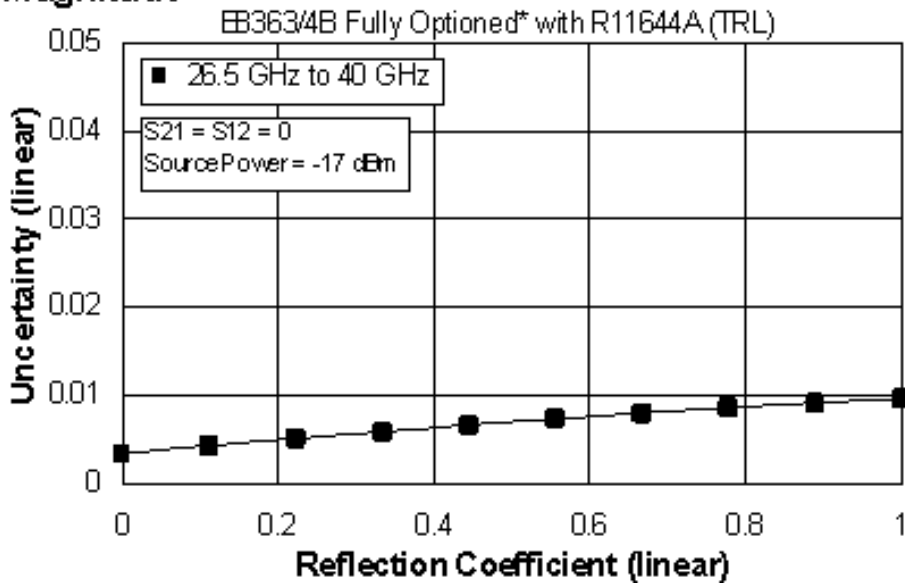

### Phase

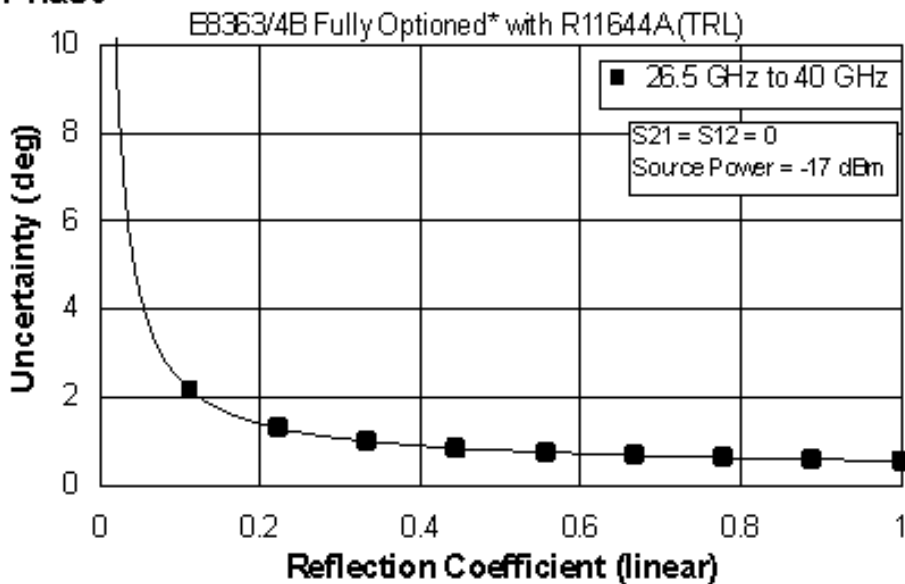

\* Configurable Test Set, Extended Power Range & Bias-Tees, Receiver Attenuators, Frequency Offset Mode, and Reference Channel Transfer Switch (E836xB/C - Option 014, UNL, 016, 080, and 081)

## E8363B/C AND E8364B/C Corrected System Performance with WR-42 Connectors

**Table 27.** K11644A Calibration Kit

Standard Configuration and Standard Power Range  
(E8363B/C AND E8364B/C)

Applies to the, E8363B/C AND E8364B/C analyzers, K11644A (WR-42) calibration kit, 85134F flexible test port cable set with the K281C launch set, and a full 2-port calibration. Also applies to the following condition:

Environmental temperature  $23^{\circ} \pm 3^{\circ} \text{C}$ , with  $< 1^{\circ} \text{C}$  deviation from calibration temperature

Description	Specification (dB)	
	18 to 20 GHz	20 to 26.5 GHz
Directivity	50	50
Source Match	50	50
Load Match	50	50
Reflection Tracking	$\pm 0.000$ $+0.02/^{\circ}\text{C}$	$\pm 0.000$ $+0.02/^{\circ}\text{C}$
Transmission Tracking	$\pm 0.014$ $+0.02/^{\circ}\text{C}$	$\pm 0.018$ $+0.02/^{\circ}\text{C}$

NOTE: The following graphs also apply to the “C” model of the analyzers.

**Transmission Uncertainty (Specifications)**

**Magnitude**

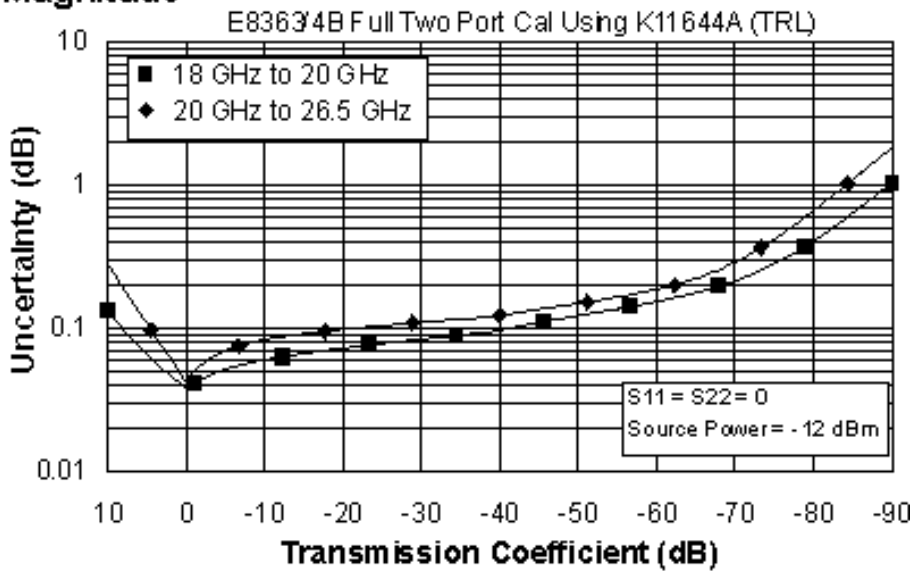

**Phase**

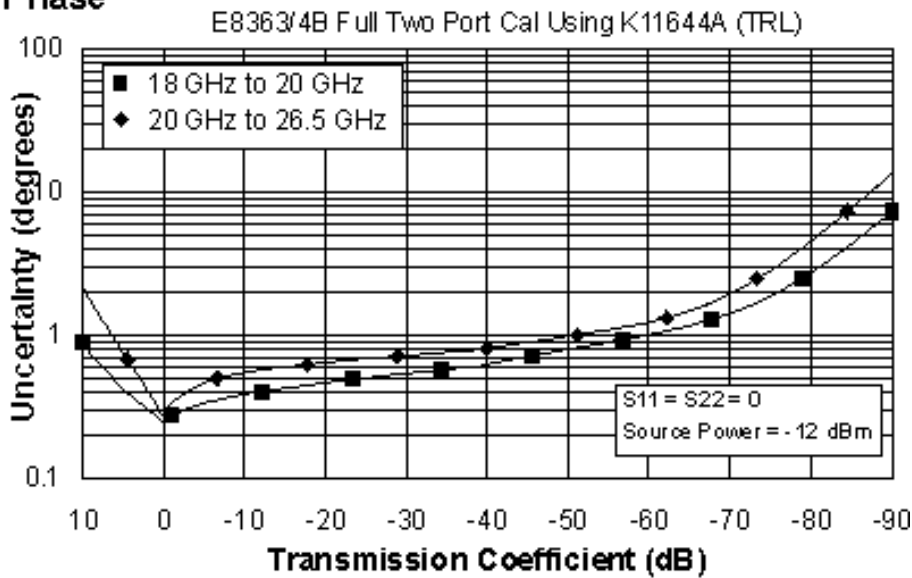

## Reflection Uncertainty (Specifications)

### Magnitude

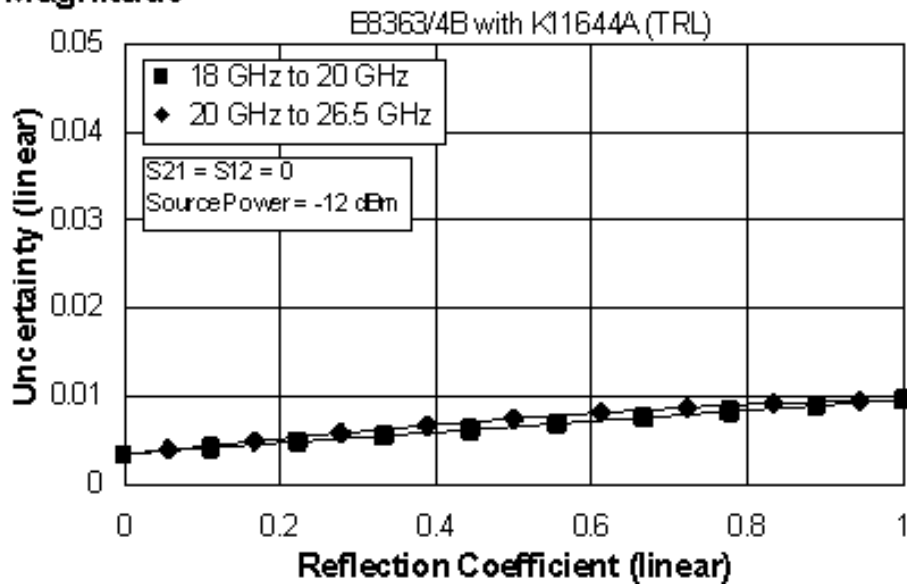

### Phase

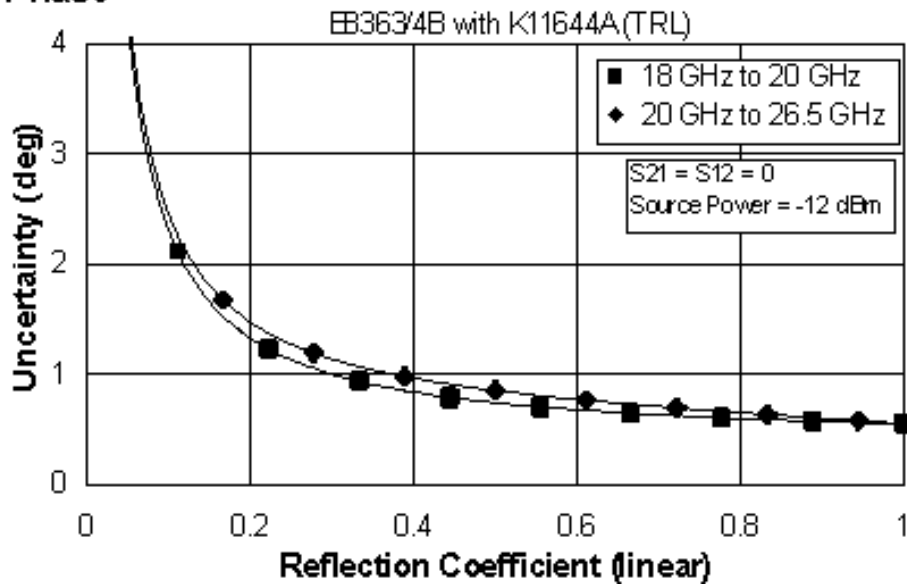

**Table 28. K11644A Calibration Kit**

Fully Optioned (E836xB/C - Option 014, UNL, 016, 080, and 081)

Configurable Test Set, Extended Power Range & Bias-Tees, Receiver Attenuators, Frequency Offset Mode, and Reference Channel Transfer Switch

Applies to the, E8363B/C AND E8364B/C analyzers, K11644A (WR-42) calibration kit, 85134F flexible test port cable set with the K281C launch set, and a full 2-port calibration. Also applies to the following condition:

Environmental temperature 23° ±3 °C, with < 1 °C deviation from calibration temperature

Description	Specification (dB)	
	18 to 20 GHz	20 to 26.5 GHz
Directivity	50	50
Source Match	50	50
Load Match	50	50
Reflection Tracking	±0.000 +0.02/°C	±0.000 +0.02/°C
Transmission Tracking	±0.016 +0.02/°C	±0.019 +0.02/°C



NOTE: The following graphs also apply to the "C" model of the analyzers.

**Transmission Uncertainty (Specifications)**

**Magnitude**

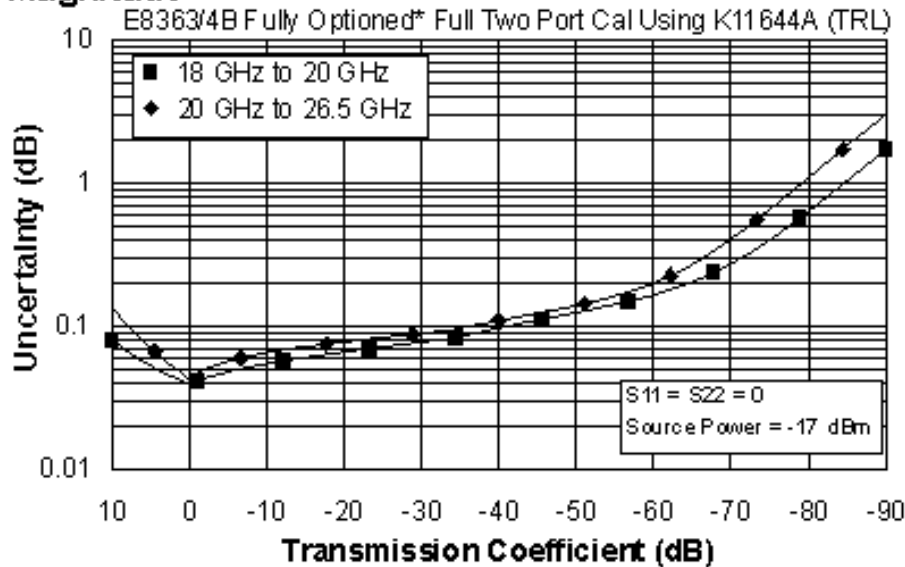

**Phase**

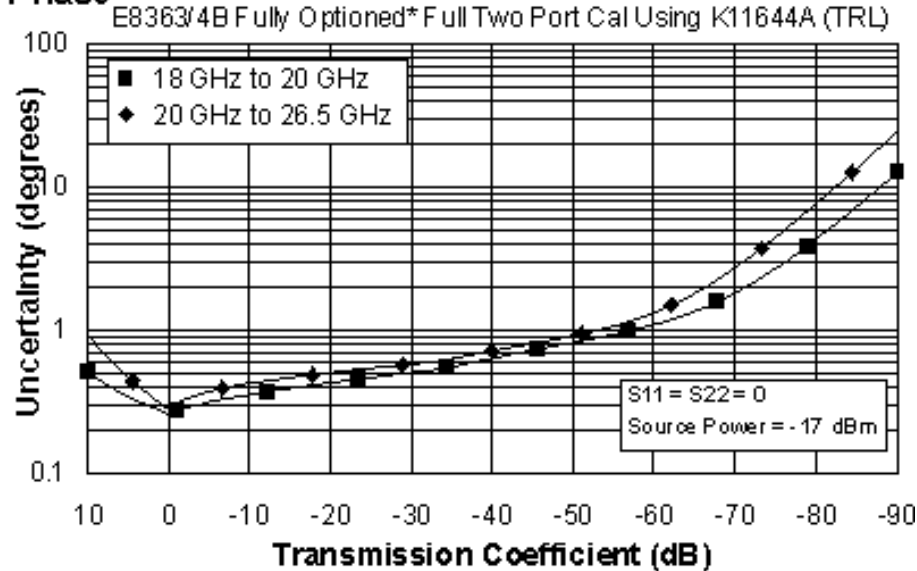

\* Configurable Test Set, Extended Power Range & Bias-Tees, Receiver Attenuators, Frequency Offset Mode, and Reference Channel Transfer Switch (E836xB/C - Option 014, UNL, 016, 080, and 081)

## Reflection Uncertainty (Specifications)

### Magnitude

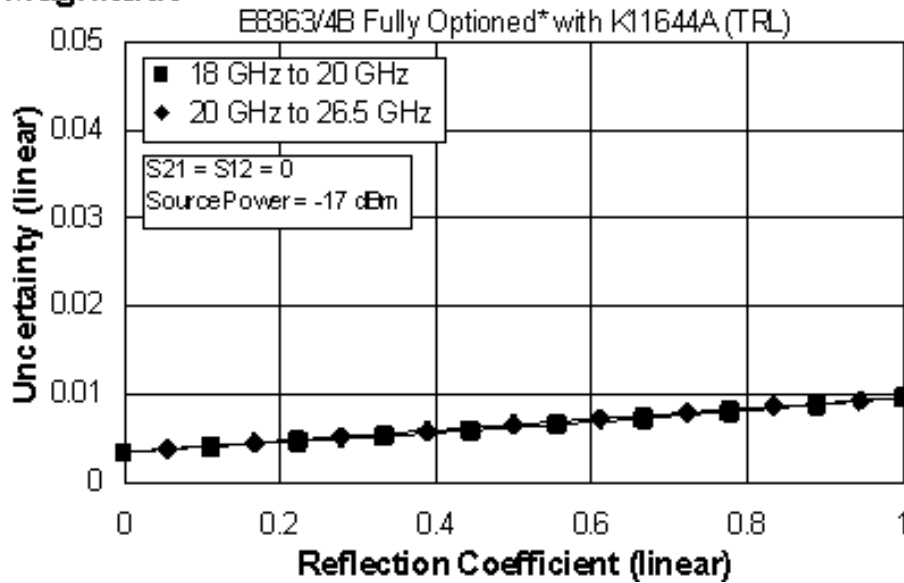

### Phase

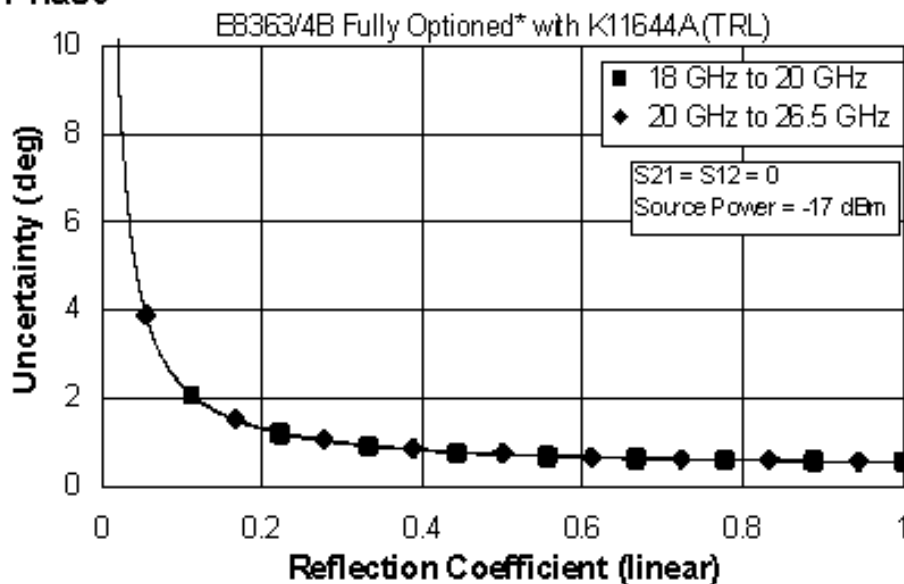

\* Configurable Test Set, Extended Power Range & Bias-Tees, Receiver Attenuators, Frequency Offset Mode, and Reference Channel Transfer Switch (E836xB/C - Option 014, UNL, 016, 080, and 081)

## E836xB/C Corrected System Performance with WR-62 Connectors

**Table 29.** P11644A Calibration Kit  
Standard Configuration and Standard Power Range  
(E836xB/C)

Applies to the, E836xB/C analyzers, P11644A (WR-62) calibration kit, 85132F flexible test port cable set with the P281B and P281C launch sets, and a full 2-port calibration. Also applies to the following condition:

Environmental temperature  $23^{\circ} \pm 3^{\circ} \text{C}$ , with  $< 1^{\circ} \text{C}$  deviation from calibration temperature

Description	Specification (dB)
	<b>12.4 to 18 GHz</b>
Directivity	50
Source Match	50
Load Match	50
Reflection Tracking	$\pm 0.000$ $+0.02/^{\circ}\text{C}$
Transmission Tracking	$\pm 0.014$ $+0.02/^{\circ}\text{C}$

NOTE: The following graphs also apply to the "C" model of the analyzers.

**Transmission Uncertainty (Specifications)**

**Magnitude**

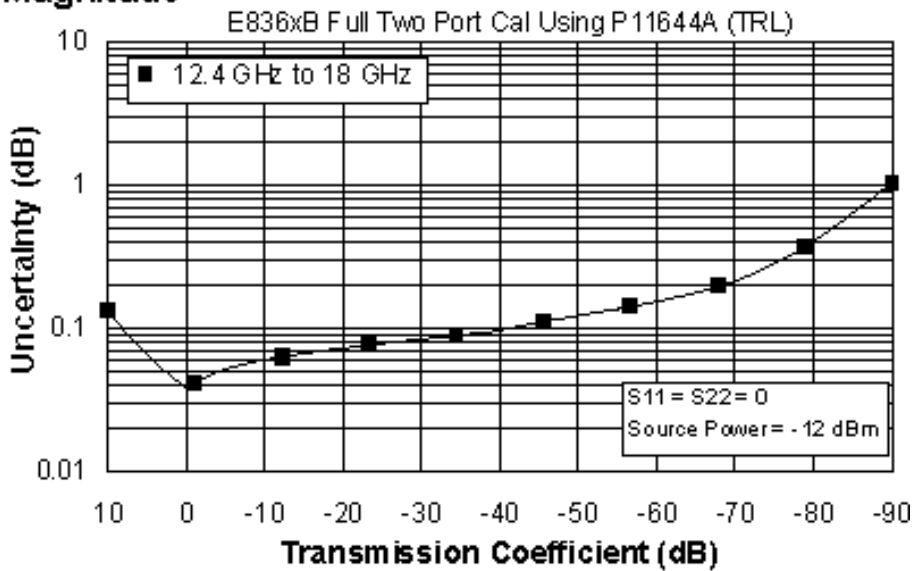

**Phase**

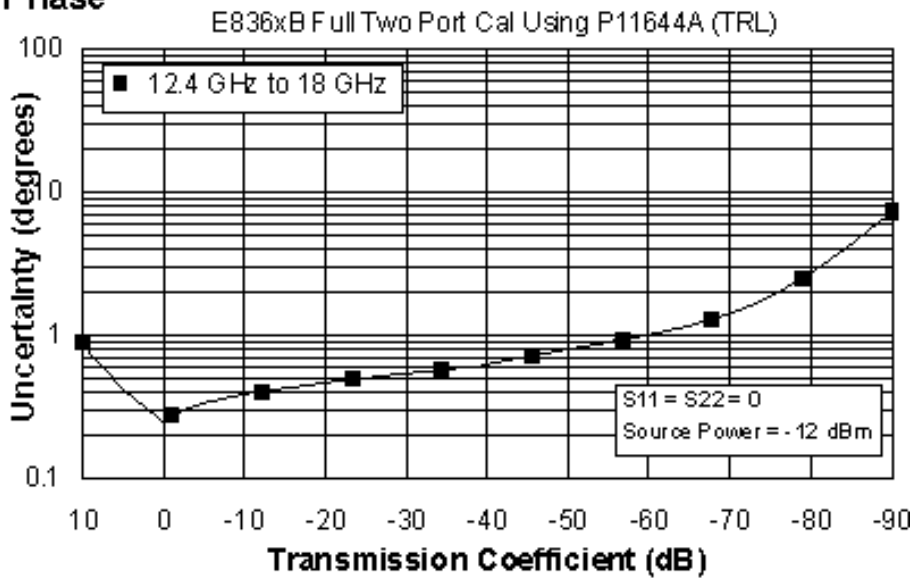

## Reflection Uncertainty (Specifications)

### Magnitude

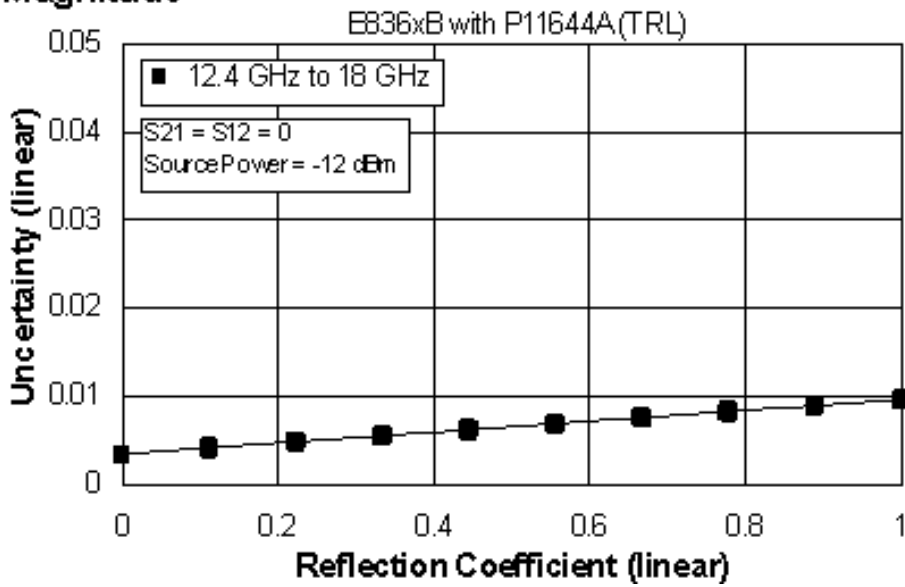

### Phase

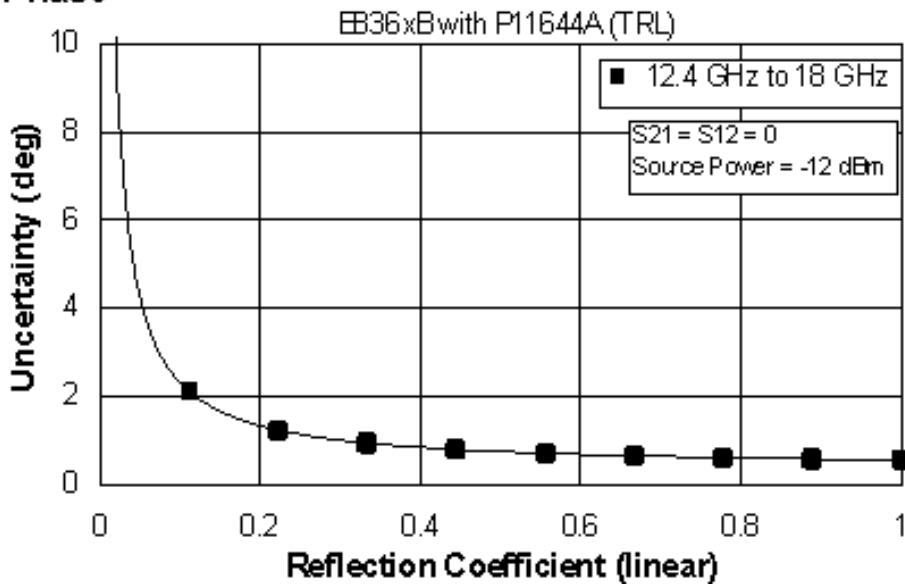

**Table 30. P11644A Calibration Kit**

Fully Optioned (E836xB/C - Option 014, UNL, 016, 080, and 081)

Configurable Test Set, Extended Power Range & Bias-Tees, Receiver Attenuators, Frequency Offset Mode, and Reference Channel Transfer Switch

Applies to the, E836xB/C analyzers, P11644A (WR-62) calibration kit, 85132F flexible test port cable set with the P281B and P281C launch sets, and a full 2-port calibration. Also applies to the following condition:

Environmental temperature 23° ±3 °C, with < 1 °C deviation from calibration temperature

Description	Specification (dB)
	<b>12.4 to 18 GHz</b>
Directivity	50
Source Match	50
Load Match	50
Reflection Tracking	±0.000 +0.02/°C
Transmission Tracking	±0.016 +0.02/°C

NOTE: The following graphs also apply to the “C” model of the analyzers.

**Transmission Uncertainty (Specifications)**

**Magnitude**

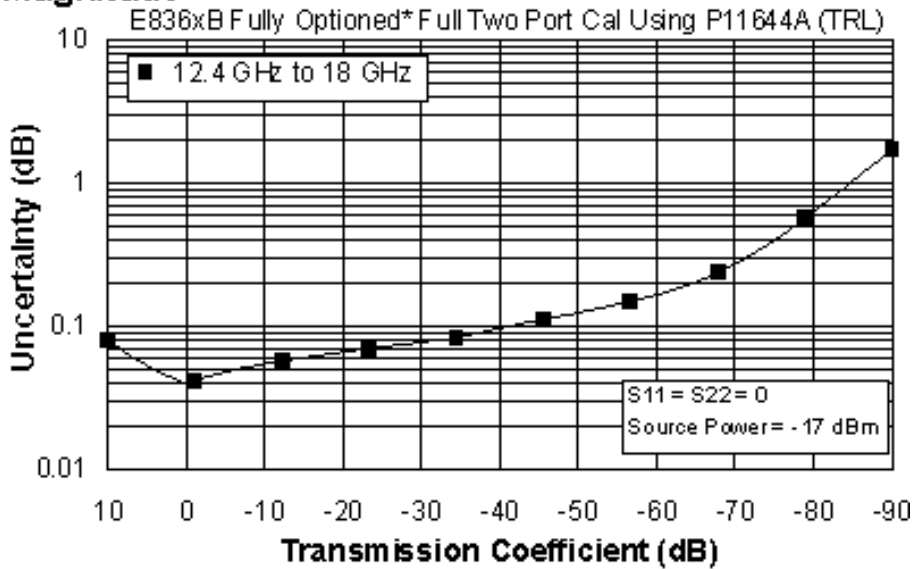

**Phase**

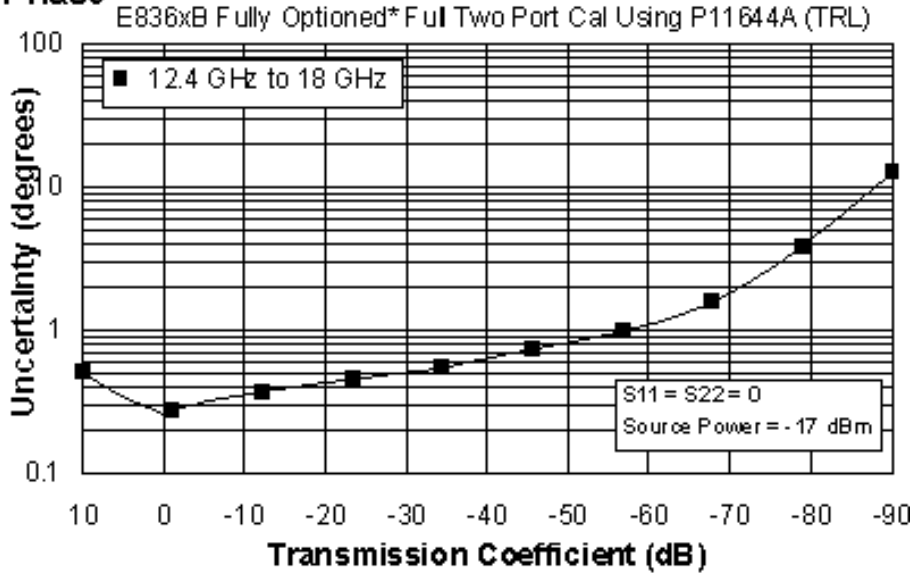

\* Configurable Test Set, Extended Power Range & Bias-Tees, Receiver Attenuators, Frequency Offset Mode, and Reference Channel Transfer Switch (E836xB/C - Option 014, UNL, 016, 080, and 081)

## Reflection Uncertainty (Specifications)

### Magnitude

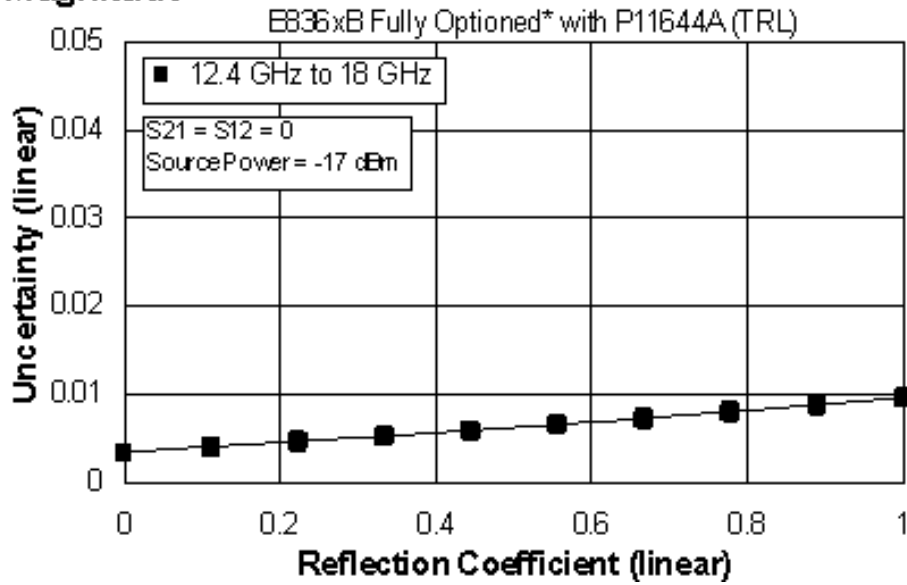

### Phase

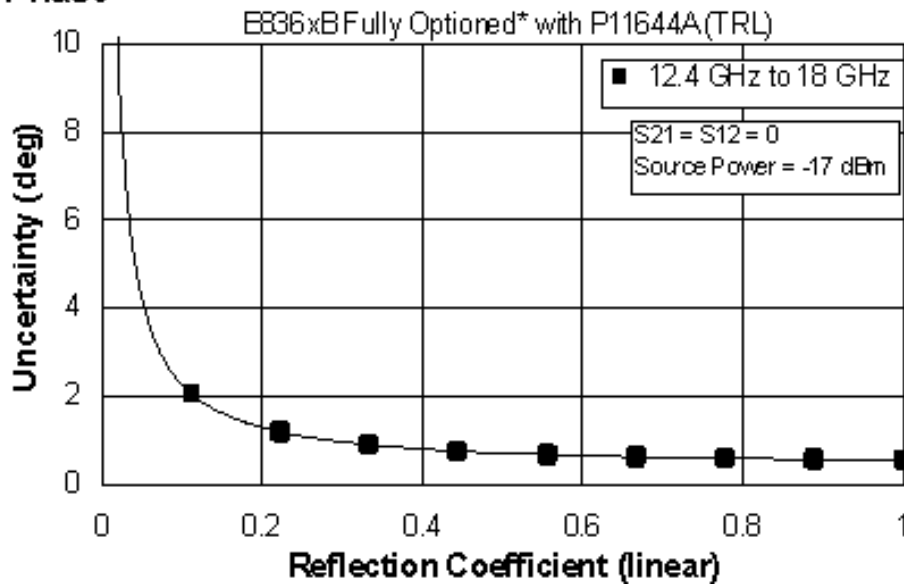

\* Configurable Test Set, Extended Power Range & Bias-Tees, Receiver Attenuators, Frequency Offset Mode, and Reference Channel Transfer Switch (E836xB/C - Option 014, UNL, 016, 080, and 081)



**E836xB/C Corrected System Performance with WR-90 Connectors**

**Table 31. X11644A Calibration Kit**  
**Standard Configuration and Standard Power Range**  
 (E836xB/C)

Applies to the, E836xB/C analyzers, X11644A (WR-90) calibration kit, 85133F flexible test port cable set with the X281A and X281C launch sets, and a full 2-port calibration. Also applies to the following condition:

Environmental temperature 23° ±3 °C, with < 1 °C deviation from calibration temperature

<b>Description</b>	<b>Specification (dB)</b>
	<b>8.2 to 12.4 GHz</b>
Directivity	50
Source Match	50
Load Match	50
Reflection Tracking	±0.000 +0.02/°C
Transmission Tracking	±0.014 +0.02/°C

NOTE: The following graphs also apply to the “C” model of the analyzers.

**Transmission Uncertainty (Specifications)**

**Magnitude**

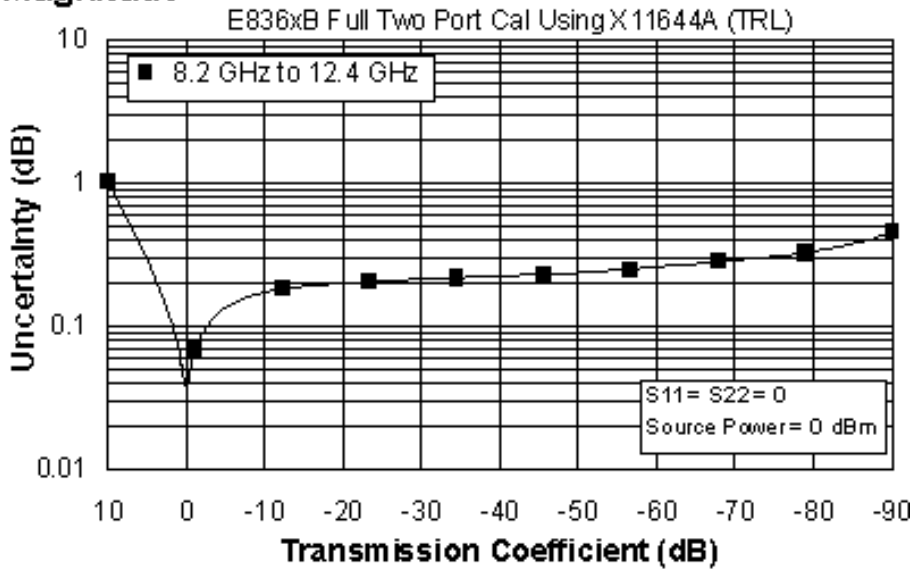

**Phase**

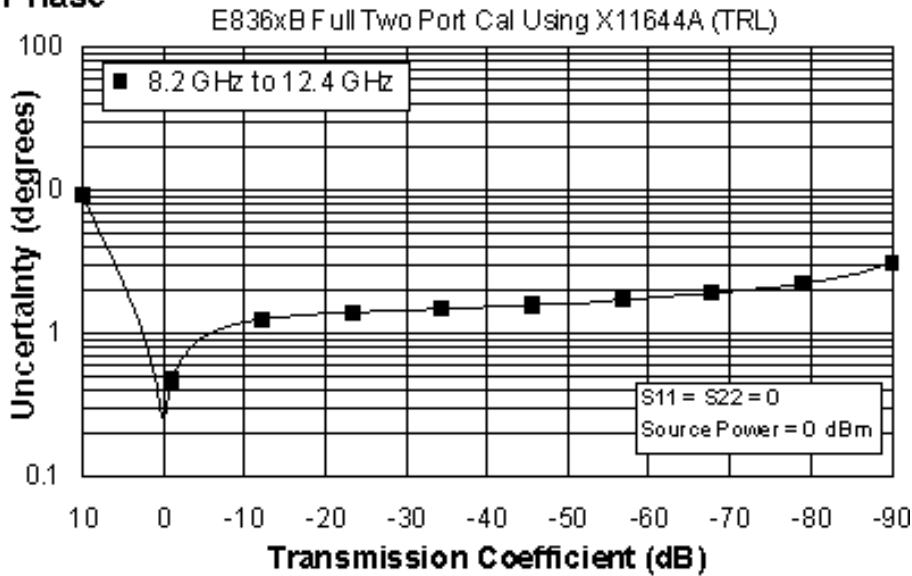

## Reflection Uncertainty (Specifications)

### Magnitude

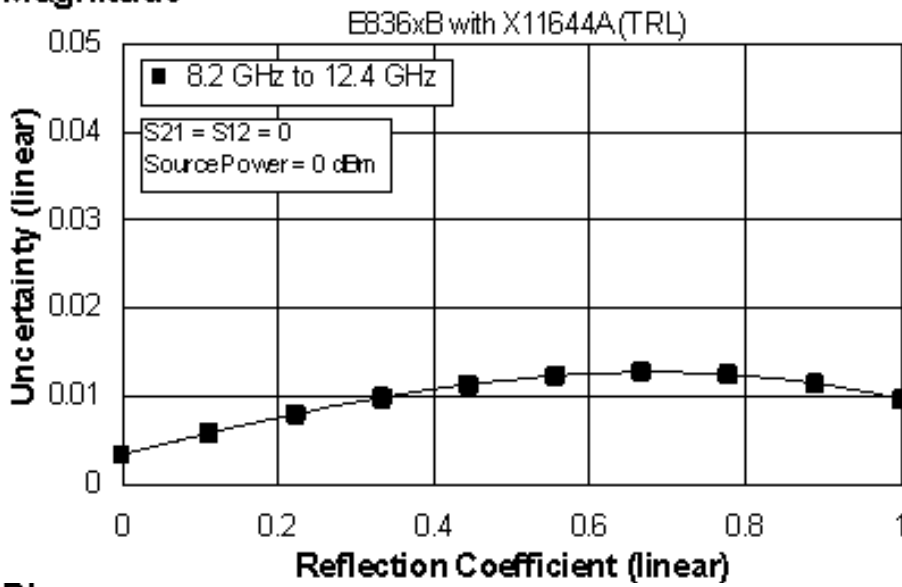

### Phase

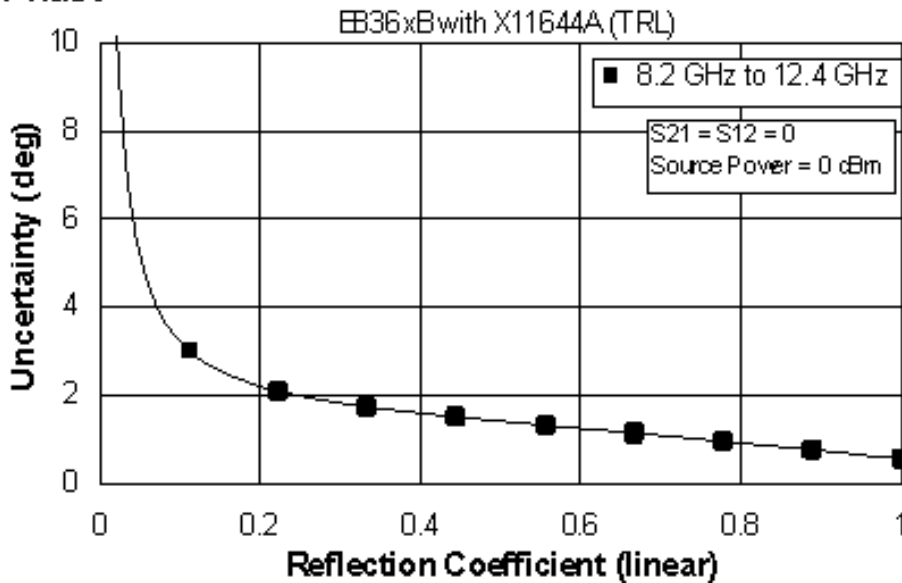

**Table 32. X11644A Calibration Kit**

Fully Optioned (E836xB/C - Option 014, UNL, 016, 080, and 081)

Configurable Test Set, Extended Power Range & Bias-Tees, Receiver Attenuators, Frequency Offset Mode, and Reference Channel Transfer Switch

Applies to the, E836xB/C analyzers, X11644A (WR-90) calibration kit, 85133F flexible test port cable set with the X281A and X281C launch sets, and a full 2-port calibration. Also applies to the following condition:

Environmental temperature 23° ±3 °C, with < 1 °C deviation from calibration temperature

Description	Specification (dB)
	<b>8.2 to 12.4 GHz</b>
Directivity	50
Source Match	50
Load Match	50
Reflection Tracking	±0.000 +0.02/°C
Transmission Tracking	±0.016 +0.02/°C

NOTE: The following graphs also apply to the “C” model of the analyzers.

**Transmission Uncertainty (Specifications)**

**Magnitude**

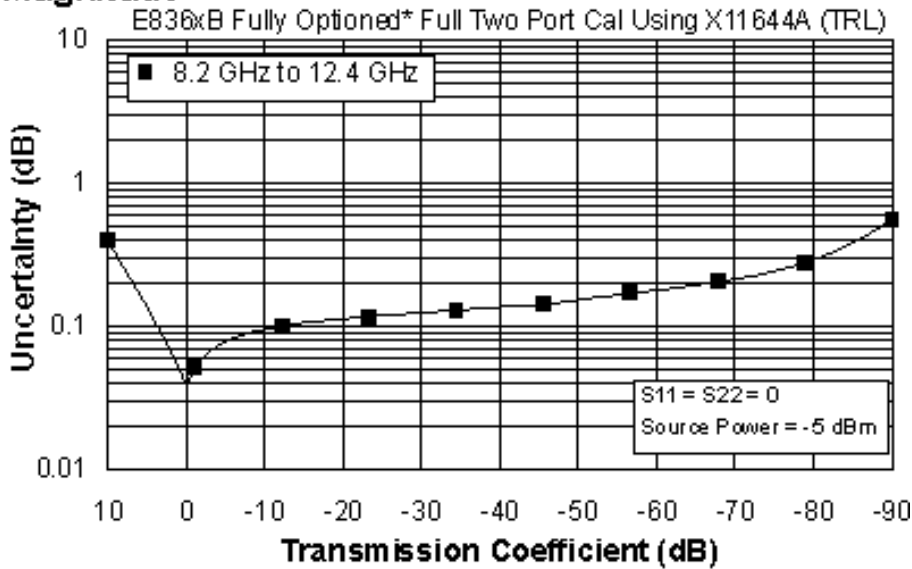

**Phase**

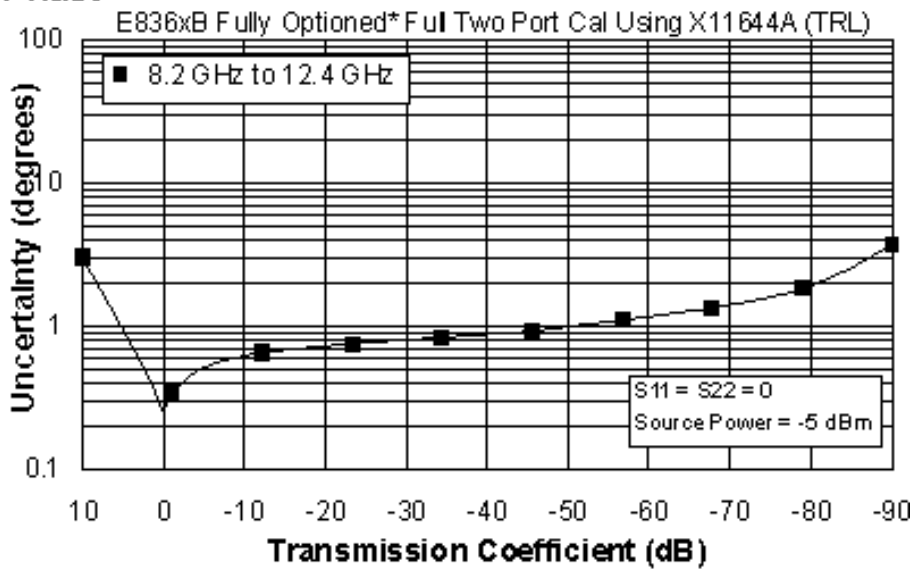

\* Configurable Test Set, Extended Power Range & Bias-Tees, Receiver Attenuators, Frequency Offset Mode, and Reference Channel Transfer Switch (E836xB/C - Option 014, UNL, 016, 080, and 081)

## Reflection Uncertainty (Specifications)

### Magnitude

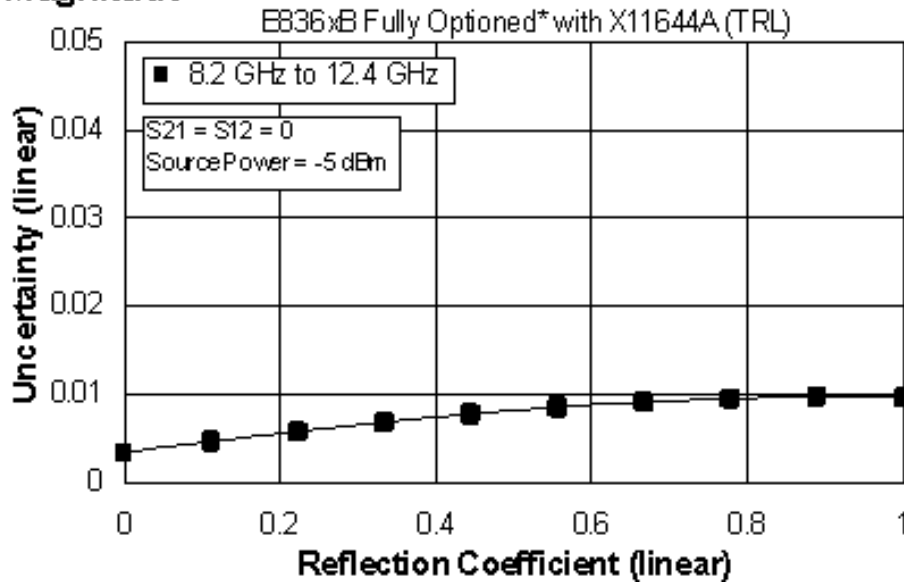

### Phase

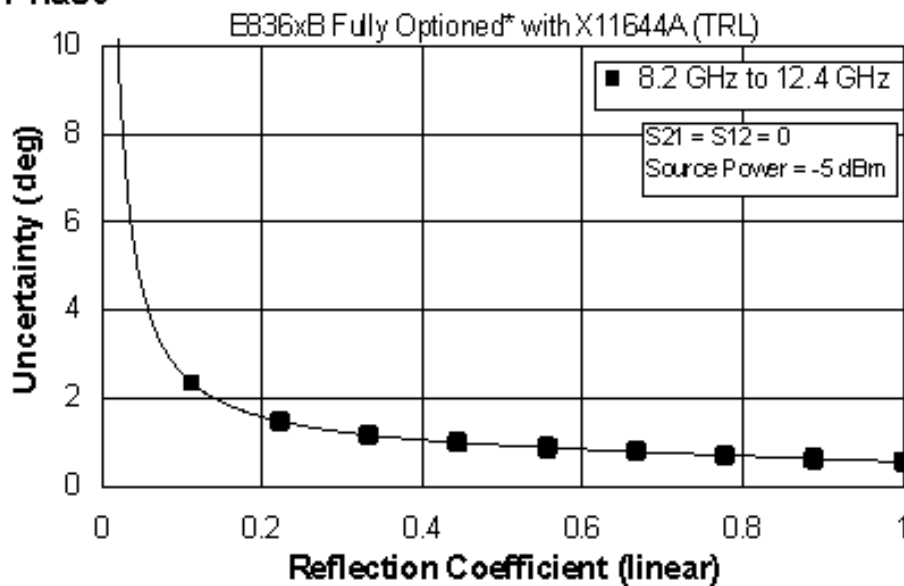

\* Configurable Test Set, Extended Power Range & Bias-Tees, Receiver Attenuators, Frequency Offset Mode, and Reference Channel Transfer Switch (E836xB/C - Option 014, UNL, 016, 080, and 081)

**Table 33. Uncorrected System Performance<sup>a</sup>**

Specifications apply over environmental temperature of 23° ±3 °C, with &lt; 1 °C deviation from the calibration temperature

Description	Specification	Supplemental Information
<b>Directivity</b>		
10 MHz to 45 MHz <sup>b</sup>	--	11 dB (typical)
45 MHz to 2 GHz	24 dB	--
2 GHz to 10 GHz	22 dB	--
10 GHz to 20 GHz	16 dB	--
20 GHz to 40 GHz	16 dB	--
40 GHz to 45 GHz	15 dB	--
45 GHz to 50 GHz	13 dB	--
<b>Source Match - Standard</b>		
10 MHz to 45 MHz <sup>b</sup>	--	11 dB (typical)
45 MHz to 2 GHz	23 dB	--
2 GHz to 10 GHz	16 dB	--
10 GHz to 20 GHz	14 dB	--
20 GHz to 40 GHz	10 dB	--
40 GHz to 45 GHz	9 dB	--
45 GHz to 50 GHz	7.5 dB	--
<b>Source Match - Opt UNL, 014 or 014/UNL</b>		
10 MHz to 45 MHz <sup>b</sup>	--	11 dB (typical)
45 MHz to 2 GHz	18 dB	--
2 GHz to 10 GHz	14 dB	--
10 GHz to 20 GHz	12 dB	--
20 GHz to 40 GHz	9 dB	--
40 GHz to 45 GHz	8 dB	--
45 GHz to 50 GHz	6 dB	--
<b>Load Match - Standard</b>		
10 MHz to 45 MHz <sup>b</sup>	--	11 dB (typical)
45 MHz to 2 GHz	23 dB	--
2 GHz to 10 GHz	14 dB	--
10 GHz to 20 GHz	10 dB	--
20 GHz to 40 GHz	9 dB	--
40 GHz to 45 GHz	9 dB	--
45 GHz to 50 GHz	8 dB	--
<b>Load Match - Opt UNL, 014 or 014/UNL</b>		
10 MHz to 45 MHz <sup>b</sup>	--	--
45 MHz to 2 GHz	17 dB	--
2 GHz to 10 GHz	13 dB	--
10 GHz to 20 GHz	10 dB	--
20 GHz to 40 GHz	9 dB	--
40 GHz to 45 GHz	9 dB	--
45 GHz to 50 GHz	7 dB	--

**Table 33 (Continued). Uncorrected System Performance<sup>a</sup>**

<b>Reflection Tracking</b>		
		<b>Typical:</b>
10 MHz to 45 MHz <sup>b</sup>	--	±1.5 dB
45 MHz to 20 GHz	--	±1.5 dB
20 GHz to 40 GHz	--	±1.5 dB
40 GHz to 50 GHz	--	±2.0 dB
<b>Transmission Tracking<sup>c</sup></b>		
		<b>Typical:</b>
10 MHz to 45 MHz <sup>b</sup>	--	±3.0 dB
45 MHz to 2 GHz	--	±1.5 dB
2 GHz to 10 GHz	--	±2.0 dB
10 GHz to 20 GHz	--	±2.5 dB
20 GHz to 40 GHz	--	±3.5 dB
40 GHz to 45 GHz	--	±4.0 dB
45 GHz to 50 GHz	--	±4.5 dB
<b>Crosstalk<sup>d</sup> - Standard</b>		
10 MHz to 45 MHz <sup>b</sup>	--	-65 dB (typical)
45 MHz to 1 GHz	-85 dB	--
1 GHz to 2 GHz	-100 dB	--
2 GHz to 20 GHz	-110 dB	--
20 GHz to 40 GHz	-108 dB	--
40 GHz to 45 GHz	-105 dB	--
45 GHz to 50 GHz	-100 dB	--
<b>Crosstalk<sup>d</sup> - Option UNL or 014</b>		
10 MHz to 45 MHz <sup>b</sup>	--	-65 dB (typical)
45 MHz to 1 GHz	-85 dB	--
1 GHz to 2 GHz	-100 dB	--
2 GHz to 20 GHz	-109 dB	--
20 GHz to 40 GHz	-106 dB	--
40 GHz to 45 GHz	-103 dB	--
45 GHz to 50 GHz	-98 dB	--
<b>Crosstalk<sup>d</sup> - Option 014/UNL</b>		
10 MHz to 45 MHz <sup>b</sup>	--	-65 dB (typical)
45 MHz to 1 GHz	-85 dB	--
1 GHz to 2 GHz	-98 dB	--
2 GHz to 10 GHz	-108 dB	--
10 GHz to 20 GHz	-107 dB	--
20 GHz to 40 GHz	-104 dB	--
40 GHz to 45 GHz	-100 dB	--
45 GHz to 50 GHz	-95 dB	--



**Table 33 (Continued). Uncorrected System Performance<sup>a</sup>**

<b>Crosstalk - Option 080 enabled<sup>b,e</sup></b>		
		<b>Typical:</b>
10 MHz to 45 MHz	--	-65
45 MHz to 1 GHz	--	-85
1 GHz to 2 GHz	--	-100
2 GHz to 10 GHz	--	-109
10 GHz to 20 GHz	--	-110
20 GHz to 40 GHz	--	-106
40 GHz to 45 GHz	--	-103
45 GHz to 50 GHz	--	-98

<sup>a</sup> Specifications apply over environment temperature of 23°C +/- 3°C, with less than 1°C deviation from the calibration temperature.

<sup>b</sup> Typical performance.

<sup>c</sup> Transmission tracking performance is strongly dependent on cable used. These typical specifications are based on the use of the Agilent thru cable (part number 85133-60016).

<sup>d</sup> Measurement conditions: normalized to a thru, measured with two shorts, 10 Hz IF bandwidth, averaging factor of 16, alternate mode, source power set to the lesser of the maximum power out or the maximum receiver power.

<sup>e</sup> 0 Hz offset.

**Table 34. Test Port Output**

Description	Specification				Supplemental
<b>Frequency Range</b>					
	Standard	Opt 014	Opt UNL	Opt 014/UNL	
E8362B/C	10 MHz to 20 GHz				--
E8363B/C	10 MHz to 40 GHz				--
E8364B/C	10 MHz to 50 GHz				--
<b>Nominal Power<sup>c</sup></b>					
E8362B/C	0 dBm	-5 dBm	-5 dBm	-5 dBm	--
E8363B/C AND E8364B/C	-12 dBm	-17 dBm	-17 dBm	-17 dBm	--
<b>Frequency Resolution</b>					
	1 Hz				--
<b>CW Accuracy</b>					
	+/-1 ppm				--
<b>Frequency Stability</b>					
					+/-0.05 ppm. -10° to 70° C, typical <sup>l</sup> ; +/-0.1 ppm/yr maximum, typical <sup>m</sup>
<b>Power Level Accuracy<sup>a</sup></b>					
10 MHz to 45 MHz <sup>b</sup>	+/-2.0 dB (typical)	+/-2.0 dB (typical)	+/-2.0 dB (typical)	+/-2.0 dB (typical)	--
45 MHz to 10 GHz	+/-1.5 dB	+/-1.5 dB	+/-1.5 dB	+/-1.5 dB	Variation from nominal power in range 0 (step attenuator at 0 dB)
10 GHz to 20 GHz	+/-2.0 dB	+/-2.0 dB	+/-2.0 dB	+/-2.0 dB	
20 GHz to 40 GHz	+/-3.0 dB	+/-3.0 dB	+/-3.0 dB	+/-3.0 dB	
40 GHz to 45 GHz	+/-3.0 dB	+/-3.5 dB	+/-3.0 dB	+/-3.5 dB	
45 GHz to 50 GHz	+/-3.0 dB	+/-4.0 dB	+/-3.0 dB	+/-4.0 dB	
<b>Power Level Linearity<sup>d</sup></b>					
10 MHz to 45 MHz <sup>b</sup>	+/-1.0 dB <sup>g</sup> (typical)				Test reference is at the nominal power level (step attenuator at 0 dB)
45 MHz to 20 GHz	+/-1.0 dB <sup>g</sup>				
20 GHz to 40 GHz	+/-1.0 dB <sup>g</sup>				
40 GHz to 50 GHz	+/-1.0 dB <sup>g</sup>				

**Table 34 (Continued). Test Port Output**

<b>Power Range<sup>a, e, f</sup></b>					
10 MHz to 45 MHz <sup>b</sup>	-25 to +2 dBm (typical)	-25 to +2 dBm (typical)	-87 to +2 dBm (typical)	-87 to +2 dBm (typical)	--
45 MHz to 10 GHz	-25 to +5 dBm	-25 to +5 dBm	-87 to +3 dBm	-87 to +3 dBm <sup>h</sup>	--
10 GHz to 20 GHz	-24 to +3 dBm	-25 to +2 dBm	-86 to +1 dBm	-87 to 0 dBm <sup>i</sup>	--
20 GHz to 30 GHz	-23 to 0 dBm	-25 to -2 dBm	-85 to -2 dBm	-87 to -4 dBm	--
30 GHz to 40 GHz	-23 to -4 dBm	-25 to -6 dBm	-85 to -6 dBm	-87 to -8 dBm	--
40 GHz to 45 GHz	-25 to -5 dBm	-27 to -7 dBm	-87 to -9 dBm	-87 to -11 dBm	--
45 GHz to 50 GHz	-25 to -10 dBm	-27 to -12 dBm	-87 to -15 dBm	-87 to -17 dBm	--
<b>Power Sweep Range (ALC)</b>					
10 MHz to 45 MHz <sup>b</sup>	27 dB (typical)	27 dB (typical)	29 dB (typical)	29 dB (typical)	
45 MHz to 10 GHz	30 dB	30 dB	30 dB	30 dB <sup>j</sup>	ALC range starts at maximum leveled output power and decreases by power level indicated in the table.
10 GHz to 20 GHz	27 dB	27 dB	27 dB	27 dB <sup>k</sup>	
20 GHz to 30 GHz	23 dB	23 dB	23 dB	23 dB	
30 GHz to 40 GHz	19 dB	19 dB	19 dB	19 dB	
40 GHz to 45 GHz	20 dB	20 dB	18 dB	16 dB	
45 GHz to 50 GHz	15 dB	15 dB	12 dB	10 dB	
<b>Power Resolution</b>					
	0.01 dB				--
<b>Phase Noise</b>					
<b>1 kHz offset from center frequency, nominal power at test port</b>					
					<b>Typical:</b>
10 MHz to 10 GHz	--	--	--	--	-60 dBc
10 GHz to 20 GHz	--	--	--	--	-55 dBc
20 GHz to 50 GHz	--	--	--	--	-50 dBc
<b>1 kHz offset from center frequency, nominal power at test port - Option 080 enabled</b>					
					<b>Typical:</b>
10 MHz to 10 GHz	--	--	--	--	-60 dBc
10 GHz to 20 GHz	--	--	--	--	-60 dBc
20 GHz to 50 GHz	--	--	--	--	-50 dBc

**Table 34 (Continued). Test Port Output**

<b>10 kHz offset from center frequency, nominal power at test port</b>					
					<b>Typical:</b>
10 MHz to 45 MHz	--	--	--	--	-70 dBc
45 MHz to 10 GHz	--	--	--	--	-70 dBc
10 GHz to 20 GHz	--	--	--	--	-65 dBc
20 GHz to 40 GHz	--	--	--	--	-55 dBc
40 GHz to 50 GHz	--	--	--	--	-55 dBc
<b>10 kHz offset from center frequency, nominal power at test port - Option 080 enabled</b>					
					<b>Typical:</b>
10 MHz to 45 MHz	--	--	--	--	-70 dBc
45 MHz to 10 GHz	--	--	--	--	-70 dBc
10 GHz to 20 GHz	--	--	--	--	-65 dBc
20 GHz to 40 GHz	--	--	--	--	-55 dBc
40 GHz to 50 GHz	--	--	--	--	-55 dBc
<b>100 kHz offset from center frequency, nominal power at test port</b>					
					<b>Typical:</b>
10 MHz to 10 GHz	--	--	--	--	-60 dBc
10 GHz to 20 GHz	--	--	--	--	-55 dBc
20 GHz to 50 GHz	--	--	--	--	-50 dBc
<b>100 kHz offset from center frequency, nominal power at test port - Option 080 enabled</b>					
					<b>Typical:</b>
10 MHz to 10 GHz	--	--	--	--	-75 dBc
10 GHz to 20 GHz	--	--	--	--	-70 dBc
20 GHz to 50 GHz	--	--	--	--	-65 dBc
<b>1 MHz offset from center frequency, nominal power at test port</b>					
					<b>Typical:</b>
10 MHz to 10 GHz	--	--	--	--	-106 dBc
10 GHz to 20 GHz	--	--	--	--	-103 dBc
20 GHz to 50 GHz	--	--	--	--	-90 dBc

**Table 34 (Continued). Test Port Output**

1 MHz offset from center frequency, nominal power at test port - Option 080 enabled					
					Typical:
10 MHz to 10 GHz	--	--	--	--	-103 dBc
10 GHz to 20 GHz	--	--	--	--	-97 dBc
20 GHz to 50 GHz	--	--	--	--	-85 dBc
Harmonics (2nd or 3rd)					
					-23 dBc typical, in power range 0
Non-Harmonic Spurious (at Nominal Output Power)					
10 MHz to 45 MHz	--	--	--	--	-50 dBc typical, for offset frequency > 1 kHz
45 MHz to 20 GHz	--	--	--	--	-50 dBc typical, for offset frequency > 1 kHz
20 GHz to 40 GHz	--	--	--	--	-30 dBc typical, for offset frequency > 1 kHz
40 GHz to 50 GHz	--	--	--	--	-30 dBc typical, for offset frequency > 1 kHz

<sup>a</sup> Test port output is a specification when the source is set to Port 1, and a characteristic when the source is set to Port 2.

<sup>b</sup> Typical performance.

<sup>c</sup> Preset power.

<sup>d</sup> Power Level Linearity is a specification when the source is set to Port 1, and a typical when the source is set to Port 2.

<sup>e</sup> Test port power is specified into nominal 50 ohms.

<sup>f</sup> Power to which the source can be set and phase lock is assured.

<sup>g</sup> +/-1.5 dB for power <= -23 dBm.

<sup>h</sup> E8362B/C only: Option H11 decreases maximum power level by 1 dB.

<sup>i</sup> E8362B/C only: Option H11 decreases maximum power level by 2 dB.

<sup>j</sup> E8362B/C only: Option H11 decreases power level by 1 dB.

<sup>k</sup> E8362B/C only: Option H11 decreases power level by 2 dB.

<sup>l</sup> Assumes no variation in time.

<sup>m</sup> Assumes no variation in temperature.

**Table 35: Test Port Input**

Description	Specification				Supplemental
	Standard	Opt 014	Opt UNL	Opt 014/UNL	
<b>Test Port Noise Floor<sup>a</sup></b>					
<b>10 Hz IF Bandwidth</b>					
10 MHz to 45 MHz <sup>b</sup>	<-77 dBm (typical)	<-77 dBm (typical)	<-77 dBm (typical)	<-77 dBm (typical)	--
45 MHz to 500 MHz <sup>c</sup>	<-89 dBm	<-89 dBm	<-89 dBm	<-89 dBm	--
500 MHz to 2 GHz	<-114 dBm	<-114 dBm	<-114 dBm	<-114 dBm	--
2 GHz to 10 GHz	<-117 dBm	<-117 dBm	<-117 dBm	<-117 dBm	--
10 GHz to 20 GHz	<-120 dBm	<-119 dBm	<-120 dBm	<-119 dBm	--
20 GHz to 40 GHz	<-114 dBm	<-113 dBm	<-114 dBm	<-113 dBm	Option 016 degrades performance by 2 dB.
40 GHz to 50 GHz	<-114 dBm	<-112 dBm	<-114 dBm	<-112 dBm	
<b>1 KHz IF Bandwidth</b>					
10 MHz to 45 MHz <sup>b</sup>	<-57 dBm (typical)	<-57 dBm (typical)	<-57 dBm (typical)	<-57 dBm (typical)	--
45 MHz to 500 MHz <sup>c</sup>	<-69 dBm	<-69 dBm	<-69 dBm	<-69 dBm	--
500 MHz to 2 GHz	<-94 dBm	<-94 dBm	<-94 dBm	<-94 dBm	--
2 GHz to 10 GHz	<-97 dBm	<-97 dBm	<-97 dBm	<-97 dBm	--
10 GHz to 20 GHz	<-100 dBm	<-99 dBm	<-100 dBm	<-99 dBm	--
20 GHz to 40 GHz	<-94 dBm	<-93 dBm	<-94 dBm	<-93 dBm	Option 016 degrades performance by 2 dB.
40 GHz to 50 GHz	<-94 dBm	<-92 dBm	<-94 dBm	<-92 dBm	

**Table 35 (Continued). Test Port Input**

<b>Test Port Noise Floor<sup>a,b</sup> Option 080 enabled<sup>d</sup></b>					
<b>10 Hz IF Bandwidth</b>					
10 MHz to 45 MHz <sup>b</sup>	<-77 dBm (typical)	<-77 dBm (typical)	<-77 dBm (typical)	<-77 dBm (typical)	--
45 MHz to 500 MHz <sup>c</sup>	<-88 dBm	<-88 dBm	<-88 dBm	<-88 dBm	--
500 MHz to 2 GHz	<-113 dBm	<-113 dBm	<-113 dBm	<-113 dBm	--
2 GHz to 10 GHz	<-116 dBm	<-116 dBm	<-116 dBm	<-116 dBm	--
10 GHz to 20 GHz	<-118 dBm	<-118 dBm	<-118 dBm	<-118 dBm	--
20 GHz to 40 GHz	<-112 dBm	<-112 dBm	<-112 dBm	<-112 dBm	Option 016 degrades performance by 2 dB.
40 GHz to 50 GHz	<-111 dBm	<-111 dBm	<-111 dBm	<-111 dBm	
<b>1 KHz IF Bandwidth</b>					
10 MHz to 45 MHz <sup>b</sup>	<-57 dBm (typical)	<-57 dBm (typical)	<-57 dBm (typical)	<-57 dBm (typical)	--
45 MHz to 500 MHz <sup>c</sup>	<-68 dBm	<-68 dBm	<-68 dBm	<-68 dBm	--
500 MHz to 2 GHz	<-93 dBm	<-93 dBm	<-93 dBm	<-93 dBm	--
2 GHz to 10 GHz	<-96 dBm	<-96 dBm	<-96 dBm	<-96 dBm	--
10 GHz to 20 GHz	<-98 dBm	<-98 dBm	<-98 dBm	<-98 dBm	--
20 GHz to 40 GHz	<-92 dBm	<-92 dBm	<-92 dBm	<-92 dBm	Option 016 degrades performance by 2 dB.
40 GHz to 50 GHz	<-91 dBm	<-91 dBm	<-91 dBm	<-91 dBm	

**Table 35 (Continued). Test Port Input**

<b>Direct Receiver Access Input Noise Floor<sup>a,b</sup></b>					
<b>10 Hz IF Bandwidth</b>					
10 MHz to 45 MHz	--	<-127 dBm	--	<-127 dBm	--
45 MHz to 500 MHz <sup>c</sup>	--	<-127 dBm	--	<-127 dBm	--
500 MHz to 2 GHz	--	<-133 dBm	--	<-133 dBm	--
2 GHz to 10 GHz	--	<-132 dBm	--	<-132 dBm	--
10 GHz to 20 GHz	--	<-134 dBm	--	<-134 dBm	--
20 GHz to 40 GHz	--	<-125 dBm	--	<-125 dBm	Option 016 degrades performance by 2 dB.
40 GHz to 50 GHz	--	<-123 dBm	--	<-123 dBm	
<b>1 KHz IF Bandwidth</b>					
10 MHz to 45 MHz	--	<-107 dBm	--	<-107 dBm	--
45 MHz to 500 MHz <sup>c</sup>	--	<-107 dBm	--	<-107 dBm	--
500 MHz to 2 GHz	--	<-113 dBm	--	<-113 dBm	--
2 GHz to 10 GHz	--	<-112 dBm	--	<-112 dBm	--
10 GHz to 20 GHz	--	<-114 dBm	--	<-114 dBm	--
20 GHz to 40 GHz	--	<-105 dBm	--	<-105 dBm	Option 016 degrades performance by 2 dB.
40 GHz to 50 GHz	--	<-103 dBm	--	<-103 dBm	



**Table 35 (Continued). Test Port Input**

<b>Direct Receiver Access Input Noise Floor<sup>a,b</sup> - Option 080 enabled<sup>d</sup></b>					
<b>10 Hz IF Bandwidth</b>					
10 MHz to 45 MHz	--	<-127 dBm	--	<-127 dBm	--
45 MHz to 500 MHz <sup>c</sup>	--	<-126 dBm	--	<-126 dBm	--
500 MHz to 2 GHz	--	<-132 dBm	--	<-132 dBm	--
2 GHz to 10 GHz	--	<-131 dBm	--	<-131 dBm	--
10 GHz to 20 GHz	--	<-133 dBm	--	<-133 dBm	--
20 GHz to 40 GHz	--	<-124 dBm	--	<-124 dBm	Option 016 degrades performance by 2 dB.
40 GHz to 50 GHz	--	<-122 dBm	--	<-122 dBm	
<b>1 KHz IF Bandwidth</b>					
10 MHz to 45 MHz	--	<-107 dBm	--	<-107 dBm	--
45 MHz to 500 MHz <sup>c</sup>	--	<-106 dBm	--	<-106 dBm	--
500 MHz to 2 GHz	--	<-112 dBm	--	<-112 dBm	--
2 GHz to 10 GHz	--	<-111 dBm	--	<-111 dBm	--
10 GHz to 20 GHz	--	<-113 dBm	--	<-113 dBm	--
20 GHz to 40 GHz	--	<-104 dBm	--	<-104 dBm	Option 016 degrades performance by 2 dB.
40 GHz to 50 GHz	--	<-102 dBm	--	<-102 dBm	
<b>Receiver Compression Level (Measured at Test Ports)</b>					
10 MHz to 20 GHz	<0.1 dB at -5 dBm <sup>g</sup> and <0.45 dB at +5 dBm				--
20 GHz to 30 GHz	<0.1 dB at -9.5 dBm <sup>g</sup> and <0.45 dB at 0 dBm				--
30 GHz to 40 GHz	<0.1 dB at -12.5 dBm <sup>g</sup> and <0.45 dB at -3 dBm				--
40 GHz to 50 GHz	<0.1 dB at -12.5 dBm <sup>g</sup> and <0.45 dB at -3 dBm				--
<b>System Compression Level</b>					
	maximum output power				See <a href="#">dynamic accuracy table</a>

**Table 35 (Continued).** Test Port Input

<b>Third Order Intercept - Tone spacing from 100 kHz - 5 MHz</b>		
		<b>Typical</b>
10 MHz to 150 MHz	--	+33 dBm
150 MHz to 300 MHz	--	+34 dBm
300 MHz to 500 MHz	--	+30 dBm
500 MHz to 20 GHz	--	+24 dBm
20 to 40 GHz	--	+18 dBm
40 to 50 GHz	--	+15 dBm
<b>Third Order Intercept - Tone spacing from 5 MHz - 20 MHz</b>		
		<b>Typical</b>
10 MHz to 500 MHz	--	+20 dBm
500 MHz to 20 GHz	--	+20 dBm
20 to 40 GHz	--	+16 dBm
40 to 50 GHz	--	+15 dBm
<b>Third Order Intercept - Tone spacing from 20 MHz - 50 MHz</b>		
		<b>Typical</b>
10 MHz to 500 MHz	--	+26 dBm
500 MHz to 20 GHz	--	+26 dBm
20 to 40 GHz	--	+20 dBm
40 to 50 GHz	--	+19 dBm
<b>Trace Noise Magnitude</b>		
1 kHz IF bandwidth. Ratio measurement, nominal power at test port.		
10 MHz to 45 MHz <sup>b</sup>	--	<0.050 dB rms (typical)
45 MHz to 500 MHz <sup>e</sup>	<0.010 dB rms	--
500 MHz to 20 GHz	<0.006 dB rms	--
20 GHz to 40 GHz	<0.006 dB rms	--
40 GHz to 50 GHz	<0.006 dB rms	--

**Table 35 (Continued). Test Port Input**

<b>Trace Noise Magnitude - Option 080 enabled<sup>b,d</sup></b>		
1 kHz IF bandwidth. Ratio measurement, nominal power at test port.		<b>Typical</b>
10 MHz to 45 MHz	--	<0.060 dB rms
45 MHz to 500 MHz <sup>e</sup>	--	<0.010 dB rms
500 MHz to 20 GHz	--	<0.006 dB rms
20 GHz to 40 GHz	--	<0.007 dB rms
40 GHz to 50 GHz	--	<0.008 dB rms
<b>Trace Noise Phase</b>		
1 kHz IF bandwidth. Ratio measurement, nominal power at test port.		
10 MHz to 45 MHz <sup>b</sup>	<0.350° rms (typical)	--
45 MHz to 500 MHz	<0.100° rms	--
500 MHz to 20 GHz	<0.060° rms	--
20 GHz to 40 GHz	<0.100° rms	--
40 GHz to 50 GHz	<0.100° rms	--
<b>Trace Noise Phase - Option 080 enabled<sup>b,d</sup></b>		
1 kHz IF bandwidth. Ratio measurement, nominal power at test port.		<b>Typical</b>
10 MHz to 45 MHz	--	<0.350° rms
45 MHz to 500 MHz <sup>e</sup>	--	<0.100° rms
500 MHz to 20 GHz	--	<0.060° rms
20 GHz to 40 GHz	--	<0.100° rms
40 GHz to 50 GHz	--	<0.100° rms
<b>Reference Level Magnitude</b>		
Range	+/-200 dB	--
Resolution	0.001 dB	--
<b>Reference Level Phase</b>		
Range	+/-500°	--
Resolution	0.01°	--

**Table 35 (Continued). Test Port Input**

<b>Stability Magnitude<sup>d</sup></b>					
Typical ratio measurement, made at the test port.					
10 MHz to 45 MHz	--	--	--	--	+/-0.05 dB/°C
45 MHz to 20 GHz	--	--	--	--	+/-0.02 dB/°C
20 GHz to 40 GHz	--	--	--	--	+/-0.03 dB/°C
40 GHz to 50 GHz	--	--	--	--	+/-0.04 dB/°C
<b>Stability Phase<sup>d</sup></b>					
Typical ratio measurement, measured at the test port.					
10 MHz to 45 MHz	--	--	--	--	+/-0.5°/°C
45 MHz to 20 GHz	--	--	--	--	+/-0.2°/°C
20 GHz to 40 GHz	--	--	--	--	+/-0.5°/°C
40 GHz to 50 GHz	--	--	--	--	+/-0.8°/°C
<b>Damage Input Level</b>					
Test Port 1 and 2	--	--	--	--	+30 dBm or +/-40 VDC, typical
R1, R2 in	--	--	--	--	+15 dBm or +/-15 VDC, typical
A, B in	--	--	--	--	+15 dBm or +/-15 VDC, typical
Coupler Thru (Option 014 or UNL/014)	--	--	--	--	+30 dBm or +/-40 VDC, typical
Coupler Arm (Option 014 or UNL/014)	--	--	--	--	+30 dBm or +/-7 VDC, typical

<sup>a</sup>Total average (rms) noise power calculated as the mean value of a linear magnitude trace expressed in dBm.

<sup>b</sup>Typical performance.

<sup>c</sup>Noise floor may be degraded by 10 dB at particular frequencies (multiples of 5 MHz) due to spurious receiver residuals.

<sup>d</sup>0 Hz offset

<sup>e</sup>Trace noise magnitude may be degraded to 20 mdB rms at harmonic frequencies of the first IF (8.33 MHz) below 80 MHz.

<sup>f</sup>Stability is defined as a ratio measurement made at the test port.

<sup>g</sup>This compression level comes from the dynamic accuracy curve with -30 dBm reference test port power.

**Table 36. Dynamic Accuracy (Specification<sup>a</sup>)**

Accuracy of the test port input power reading relative to the reference input power level.

**NOTE: The following graphs also apply to the “C” model of the analyzers.**

### Magnitude\*

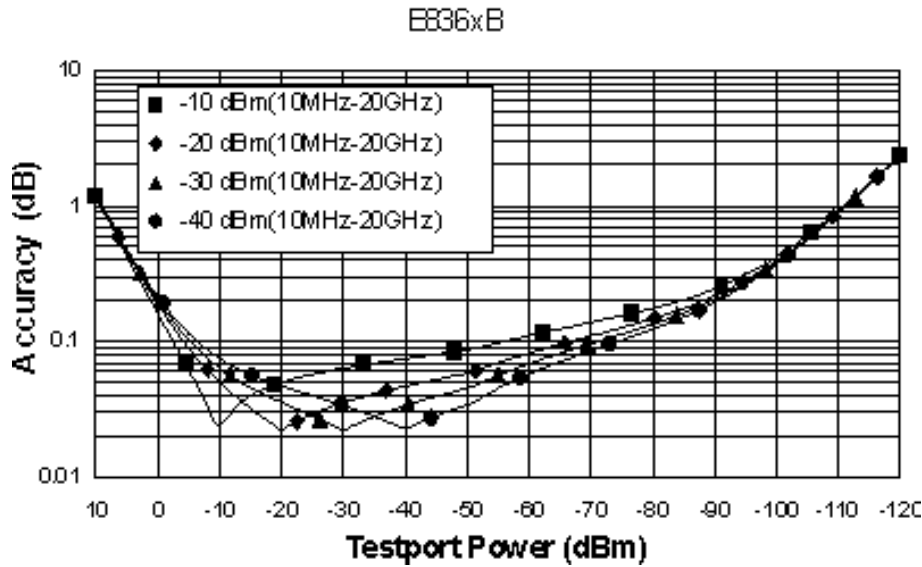

### Phase\*

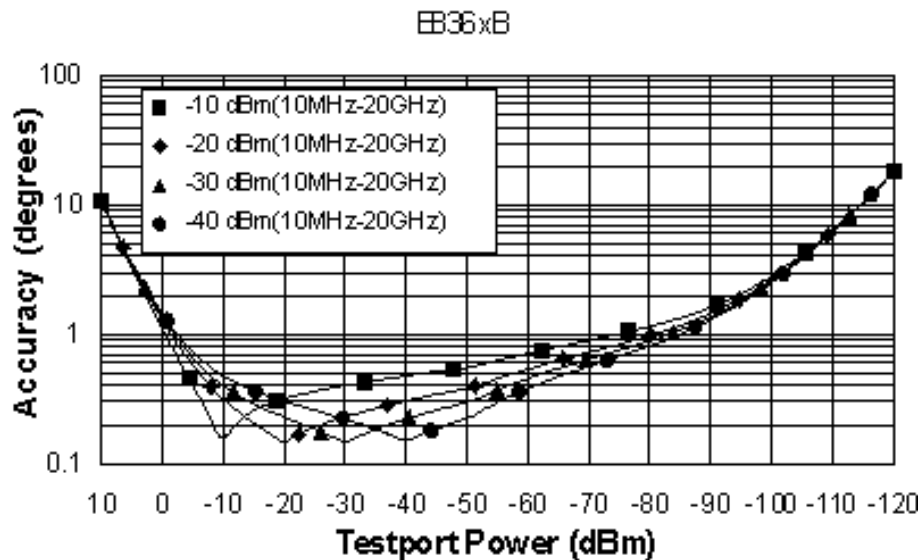

\*Below 800 MHz the coupling factor rolls off 20 dB per decade causing a shift in the dynamic accuracy curves. Please see the Uncertainty Calculator ([http://www.agilent.com/find/na\\_calculator](http://www.agilent.com/find/na_calculator)) for detailed compression values.

### Magnitude

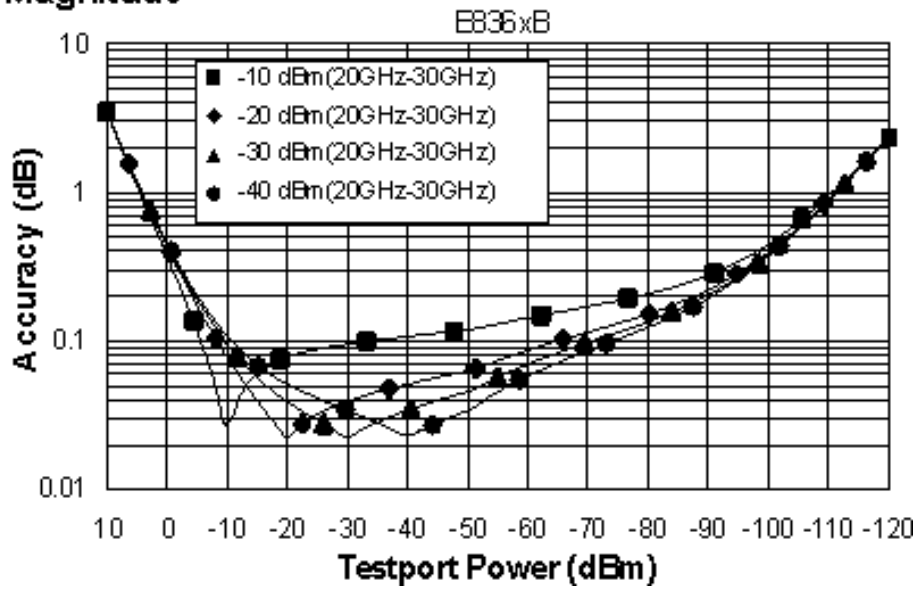

### Phase

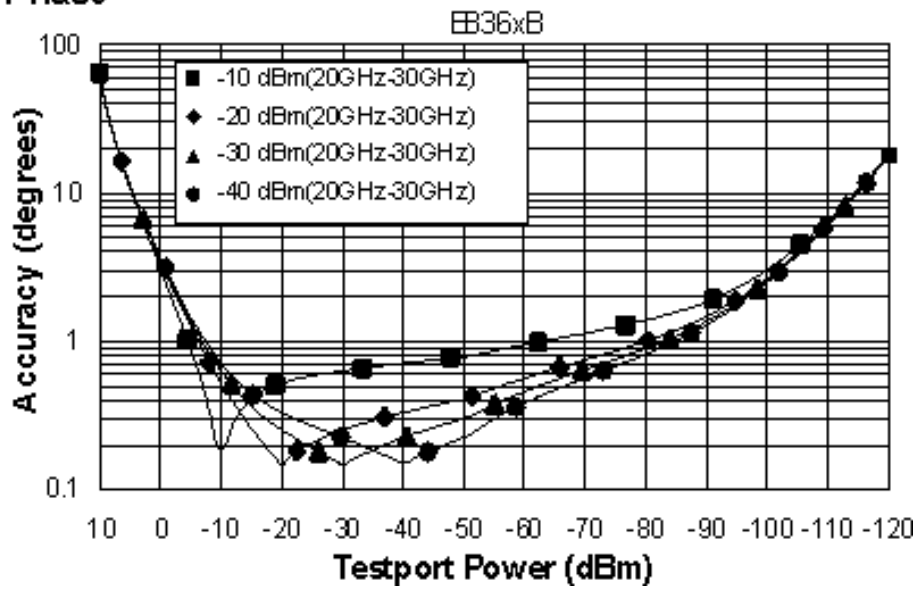

### Magnitude

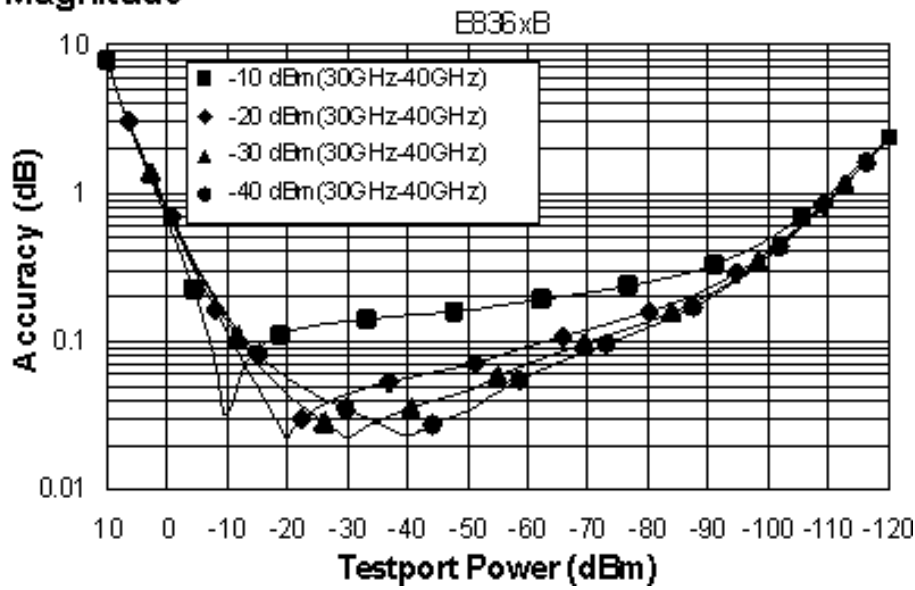

### Phase

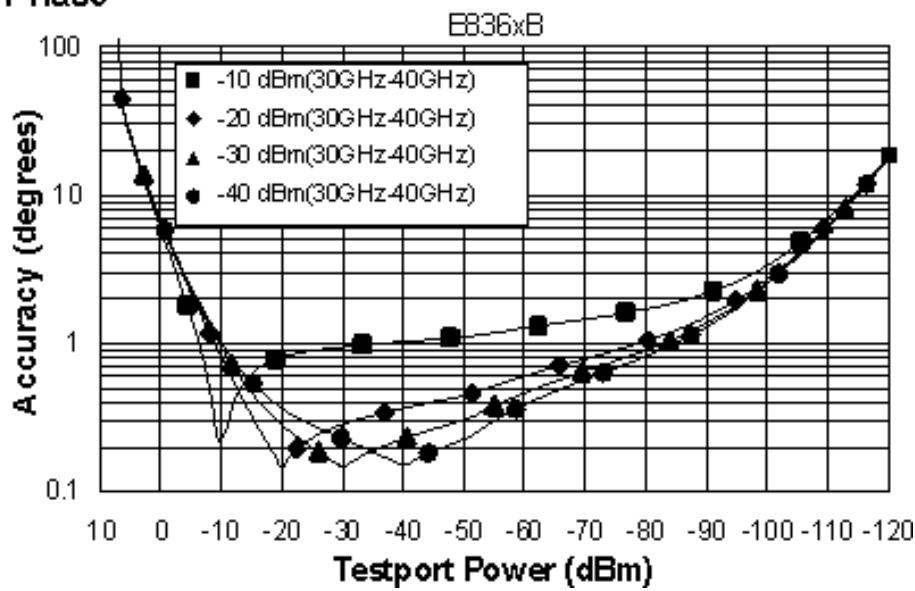

## Magnitude

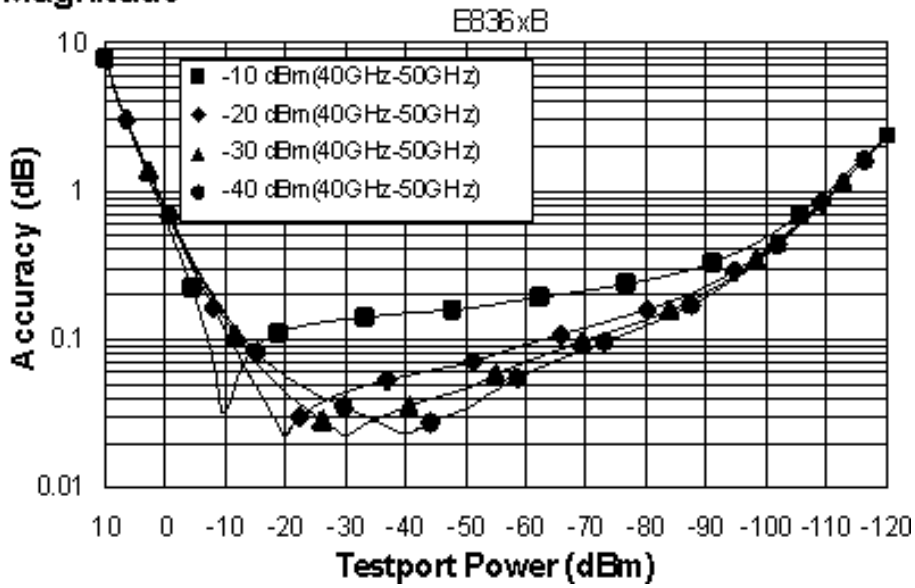

## Phase

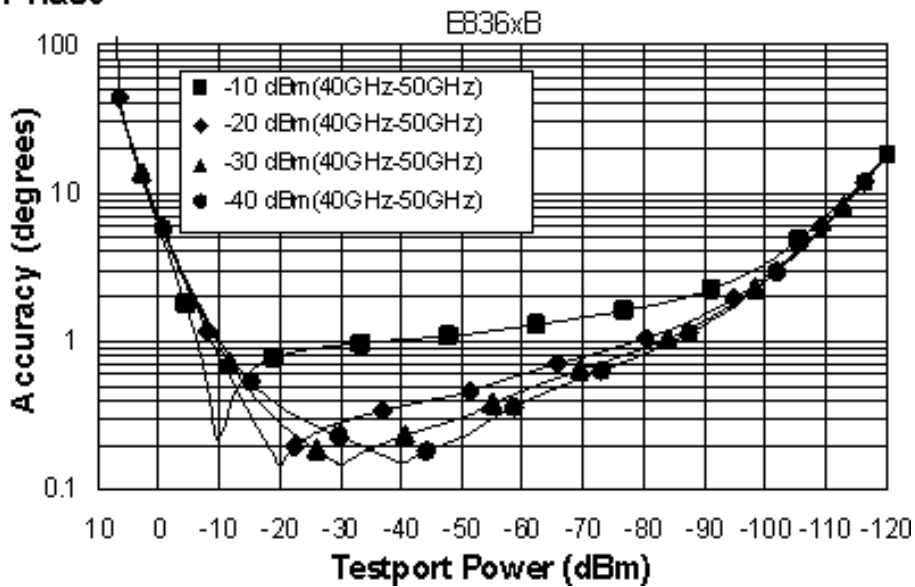

<sup>a</sup> Dynamic accuracy is verified with the following measurements:

- Compression over frequency.
- IF linearity at a single frequency of 1.195 GHz and a reference level of -20 dBm for an input power range of 0 to -120 dBm.



**Table 37. Test Port Input (Group Delay)<sup>a</sup>**

Description	Specification	Supplemental Information (typ.)
Aperture (selectable)		(frequency span)/(number of points - 1)
Maximum Aperture		20% of frequency span
Range		0.5 x (1/minimum aperture)
Maximum Delay		Limited to measuring no more than 180° of phase change within the minimum aperture.)
Accuracy		See graph below. Char.

The following graph shows characteristic group delay accuracy with full 2-port calibration and a 10 Hz IF bandwidth. Insertion loss is assumed to be < 2 dB and electrical length to be ten meters.

**NOTE: The following graph also applies to the “C” model of the analyzers.**

**Group Delay (Typical)**

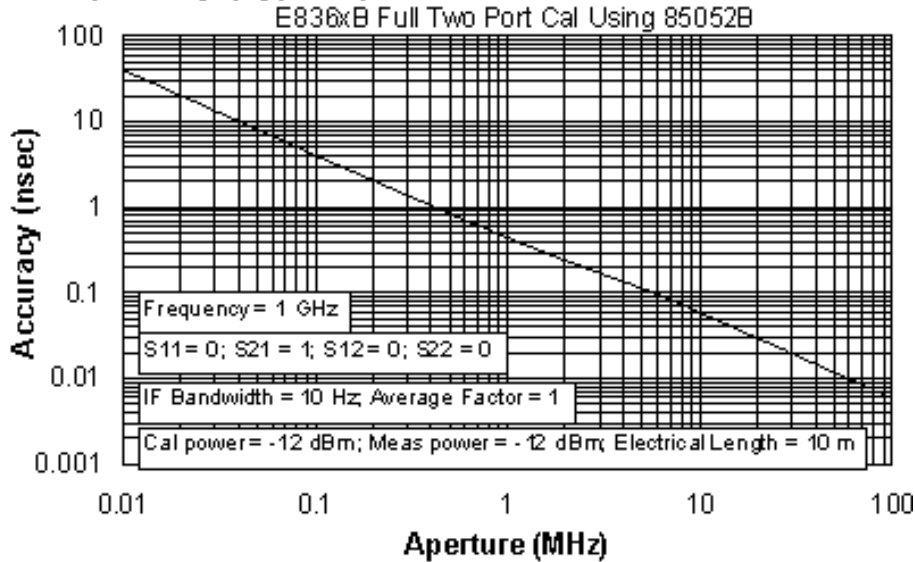

In general, the following formula can be used to determine the accuracy, in seconds, of specific group delay measurement:

$$\pm \text{Phase Accuracy (deg)} / [360 \times \text{Aperture (Hz)}]$$

Depending on the aperture and device length, the phase accuracy used is either incremental phase accuracy or worst case phase accuracy.

<sup>a</sup> Group delay is computed by measuring the phase change within a specified frequency step (determined by the frequency span and the number of points per sweep).

## General Information

**Table 38.** Miscellaneous Information

Description	Specification	Supplemental Information
System IF Bandwidth Range	--	1 Hz to 40 kHz, nominal
CPU	--	Intel® 1.1 GHz Pentium® M with 1 GByte RAM

**Table 39.** Front Panel Information

Description	Supplemental Information
<b>RF Connectors</b>	
<b>E8362B/C</b>	
Type	3.5 mm (male), 50 ohm, (nominal)
Center Pin Recession	0.002 in. (characteristic)
<b>E8363B/C AND E8364B/C</b>	
Type	2.4 mm (male), 50 ohm, (nominal)
Center Pin Recession	0.002 in. (characteristic)
<b>Display</b>	
NOTE: The PNA display must remain in the 16 bit color setting in order to comply with international emissions regulations.	
Size	21.3 cm (8.4 in) diagonal color active matrix LCD; 640 (horizontal) X 480 (vertical) resolution; 59.83 Hz vertical refresh rate; 31.41 Hz horizontal refresh rate
Refresh Rate	Vertical 59.83 Hz; Horizontal 31.41 kHz
Pixels	<p>A display is considered faulty if:</p> <ul style="list-style-type: none"> <li>• A complete row or column consists of “stuck” or “dark” pixels.</li> <li>• More than six “stuck on” pixels (but not more than three green) or more than 0.002% of the total pixels are within the LCD specifications.</li> <li>• More than twelve “dark” pixels (but no more than seven of the same color) or more than 0.004% of the total pixels are within the LCD specifications.</li> <li>• Two or more consecutive "stuck on" pixels or three or more consecutive "dark" pixel (but no more than one set of two consecutive dark pixels)</li> <li>• “Stuck on” “dark” pixels are less than 6.5 mm apart (excluding consecutive pixels)</li> </ul>
<b>Display Range</b>	
Magnitude	±200 dB (at 20 dB/div), max
Phase	±500°, max
Polar	10 pUnits, min 1000 Units, max
<b>Display Resolution</b>	
Magnitude	0.001 dB/div, min
Phase	0.01°/div, min
<b>Marker Resolution</b>	
Magnitude	0.001 dB, min
Phase	0.01°, min
Polar	0.01 mUnit, min; 0.01°, min

**Table 40. Rear Panel Information**

Description	Supplemental Information
<b>10 MHz Reference In</b>	
Connector	BNC, female
Input Frequency	10 MHz $\pm$ 10 ppm, typical
Input Level	-15 dBm to +20 dBm, typical
Input Impedance	200 $\Omega$ , nom.
<b>10 MHz Reference Out</b>	
Connector	BNC, female
Output Frequency	10 MHz $\pm$ 1 ppm, typical
Signal Type	Sine Wave, typical
Output Level	+10 dBm $\pm$ 4 dB into 50 $\Omega$ , typical
Output Impedance	50 $\Omega$ , nominal
Harmonics	<-40 dBc, typical
<b>External Trigger Rear-Panel I/O (typical)</b>	
Trigger Inputs/Outputs	BNC(f), TTL/CMOS compatible
<b>Trigger Input</b>	
Function	Measurement of next point, next channel, or next group of channels
Source	Aux I/O (pin 19) or I/O 1 (BNC (f) connector)
Signal Levels	TTL-compatible
Input impedance	5 Kohm nominal
Minimum Trigger Width	1 microsecond
Trigger modes	High or low level; positive or negative edge
Trigger Delay Range	0 to 1 second
Trigger Delay Resolution	6 microseconds (IF bandwidth => 15 kHz) or 6.2 microseconds (IF bandwidth < 15 kHz)
<b>Trigger Output</b>	
Function	Generate pulse before or after measurement (only active when trigger type is external)
Source	I/O 2 (BNC (f) connector)
Signal levels	TTL-compatible
Trigger Polarity	Positive or negative edge
Pulse Width	1 microsecond
<b>Option H11 Rear-Panel I/O (typical)</b>	
<b>External IF Inputs</b>	
Function	Allows use of external IF signals from remote mixers, bypassing the PNA's first converters
Connectors	A, R1, R2, B receivers (BNC (f) Connectors)
Input Frequency	8 1/3 MHz
Input Impedance	50 $\Omega$ nominal
RF Damage Level	-20.0 dBm
DC Damage Level	25 volts
0.1 dB Compression Point	-27.0 dBm
<b>Pulse Inputs (IF Gates)<sup>2</sup></b>	
Function	Internal receiver gates used for point-in-pulse and pulse-profile measurements
Connectors	A, R1, R2, B (BNC (f) Connectors)
Input Impedance	1 Kohm nominal
Minimum Pulse Width	20 ns for less than 1 dB deviation from theoretical performance <sup>3</sup>
DC Damage Level	5.5 volts
Drive Voltage	TTL; 0 V (off), +5 V (on) nominal

**Table 40 (Continued). Rear Panel Information**

<b>Test Set Drivers</b>	
Function	Used for driving remote mixers
Connectors	SMA (f) for RF and LO outputs
RF, LO Output Frequency Range	1.7 to 20 GHz
RF Output Power Levels	+5 dBm to -16 dBm, depending on frequency <sup>1</sup>
LO Output Power Levels	-7 dBm to -16 dBm, depending on frequency
<b>Rear Panel LO Power (Typical)</b>	
1.7 GHz- 20 GHz	-7 to -16 dBm
<b>Rear Panel RF Power 8362B (Typical)</b>	
1.7 GHz to 20 GHz	-5 to -16 dBm (at -5 dBm test port power <sup>4</sup> )
<b>Rear Panel RF Power 8363B/8364B (Typical)</b>	
1.7 GHz to 10 GHz	-2 to -12 dBm (at -5 dBm test port power <sup>4</sup> )
10 GHz to 16 GHz	0 to -8 dBm (at -5 dBm test port power <sup>4</sup> )
16 GHz to 20 GHz	+5 to -1 dBm (at -5 dBm test port power <sup>4</sup> )
<b>VGA Video Output</b>	
Connector	15-pin mini D-Sub; Drives VGA compatible monitors
Devices Supported:	
	<b>Resolutions:</b>
Flat Panel (TFT)	1024 X 768, 800 X 600, 640 X 480
Flat Panel (DSTN)	800 X 600, 640 X 480
CRT Monitor	1280 X 1024, 1024 X 768, 800 X 600, 640 X 480
	Simultaneous operation of the internal and external displays is allowed, but with 640 X 480 resolution only. If you change resolution, you can only view the external display (internal display will "white out").
<b>Bias Tee Input Connectors (Option UNL)</b>	
Connectors	BNC (f), for port 1 and port 2
Fuse	500 mA, bi-pin style
Maximum bias current	+/-200 mA with no degradation of RF specifications
Maximum bias voltage	+/-40 Volts DC
<b>Test Set IO</b>	
	25-pin D-Sub connector, available for external test set control.
<b>Aux IO</b>	
	25-pin D-Sub connector, male, analog and digital IO.
<b>Handler IO</b>	
	36-pin parallel I/O port; all input/output signals are default set to negative logic; can be reset to positive logic via GPIB command.
<b>GPIB</b>	
	24-pin D-sub (Type D-24), female; compatible with IEEE-488.
<b>Parallel Port (LPT1)</b>	
	25-pin D-Sub miniature connector, female; provides connection to printers or any other parallel port peripherals
<b>Serial Port (COM 1)</b>	
	9-pin D-Sub, male; compatible with RS-232

**Table 40 (Continued). Rear Panel Information**

<b>USB Port</b>	
	One port on front panel and five ports on rear panel. Universal Serial Bus jack, Type A configuration (4 contacts inline, contact 1 on left); female
Contact 1	Vcc: 4.75 to 5.25 VDC, 500 mA, maximum
Contact 2	-Data
Contact 3	+Data
Contact 4	Ground
<b>LAN</b>	
	10/100BaseT Ethernet, 8-pin configuration; auto selects between the two data rates
<b>Line Power<sup>5</sup></b>	
Frequency, Voltage	50/60/400 Hz for 100 – 120 V 50/60 Hz for 220 – 240 V Power supply is auto switching
Max	350 W

<sup>1</sup> Measured at -5 dBm test port power.

<sup>2</sup> Pulse input connectors are operational only with Option H08 (Pulse Measurement Capability) enabled.

<sup>3</sup> Based on deviation from signal reduction equation: Signal Reduction (dB) =  $20\log_{10}(\text{Duty\_cycle}) = 20\log_{10}(\text{pulse\_width/pulse\_repetition\_interval})$ . Measured at pulse repetition frequency of 1 MHz.

<sup>4</sup> Test port power has to be at a high enough level such that the Drop Cal does not occur. If Drop Cal occurs then the power out of the rear panel RF connector will drop by about 15 dB.

<sup>5</sup> A third-wire ground is required.

**Table 41. Analyzer Dimensions and Weight**

Description	Supplemental Information		
<b>Cabinet Dimensions</b>			
	Height	Width	Depth
Excluding front and rear panel hardware and feet	267 mm 10.5 in	426 mm 16.75 in	427 mm 16.8 in
As shipped - includes front panel connectors, rear panel bumpers, and feet.	280 mm 11.0 in	435 mm 17.1 in	470 mm 18.5 in
As shipped plus handles	280 mm 11.0 in	458 mm 18 in	501 mm 19.70 in
As shipped plus rack-mount flanges	280 mm 11.0 in	483 mm 19 in	470 mm 18.5 in
As shipped plus handles and flanges	280 mm 11.0 in	483 mm 19 in	501 mm 19.70 in
<b>Weight</b>			
<b>Net</b>			
E8362B/C	28.6 kg (63.5 lb), nominal		
E8363B/C AND E8364B/C	29 kg (64 lb), nominal		
<b>Shipping</b>			
E8362B/C	35.8 kg (79.5 lb), nominal		
E8363B/C AND E8364B/C	36.3 kg 80 lb), nominal		

**Note:** For Regulatory and Environmental information, refer to the PNA Series Installation and Quick Start Guide, located online at <http://cp.literature.agilent.com/litweb/pdf/E8356-90001.pdf>.

## Measurement Throughput Summary

**Table 42** Typical Cycle Time<sup>a,b</sup> (ms) for Measurement Completion

	Number of Points			
	201	401	1601	16,001
<b>Start 28 GHz, Stop 30 GHz, 35 kHz IF bandwidth</b>				
Uncorrected, 1-port cal	12	19	55	503
2-Port cal	29	44	124	1112
<b>Start 10 MHz, Stop 10 GHz, 35 kHz IF bandwidth</b>				
Uncorrected, 1-port cal	86	93	121	583
2-Port cal	179	199	267	1301
<b>Start 10 MHz, Stop 20 GHz, 35 kHz IF bandwidth</b>				
Uncorrected, 1-port cal	126	130	153	597
2-Port cal	264	275	335	1321
<b>Start 10 MHz, Stop 40 GHz, 35 kHz IF bandwidth</b>				
Uncorrected, 1-port cal	185	190	213	621
2-Port cal	382	401	459	1374
<b>Start 10 MHz, Stop 50 GHz, 35 kHz IF bandwidth</b>				
Uncorrected, 1-port cal	210	216	243	643
2-Port cal	436	450	522	1405
<b>Start 10 MHz, Stop 67 GHz, 35 kHz IF bandwidth</b>				
Uncorrected 1-Port cal	244	254	300	645
2-Port cal	502	524	591	1423

<sup>a</sup> Typical performance.

<sup>b</sup> Includes sweep time, retrace time and band-crossing time. Analyzer display turned off with DISPLAY:ENABLE OFF. Add 21 ms for display on. Data for one trace (S11) measurement.

**Table 43. Cycle Time vs IF Bandwidth<sup>a</sup>**

Applies to the Preset condition (201 points, correction off) except for the following changes:

- CF = 28 GHz
- Span = 100 MHz
- Display off (add 21 ms for display on)

IF Bandwidth (Hz)	Cycle Time (ms) <sup>b</sup>	Cycle Time (ms) Option 080 enabled
40,000	11	100
35,000	12	101
30,000	13	102
20,000	16	106
10,000	30	127
7000	38	138
5000	50	152
3000	74	182
1000	274	326
300	694	782
100	1905	2054
30	6091	6355
10	17916	18372

<sup>a</sup> Typical performance.

<sup>b</sup> Cycle time includes sweep and retrace time.

**Table 44. Cycle Time vs Number of Points<sup>a</sup>**

Applies to the Preset condition (35 kHz IF bandwidth, correction off) except for the following changes:

- CF = 28 GHz
- Span = 100 MHz
- Display off (add 21 ms for display on)

Number of Points	Cycle Time (ms) <sup>b</sup>
3	6
11	6
51	7
101	9
201	12
401	18
801	30
1601	55
16,001	497

<sup>a</sup> Typical performance.

<sup>b</sup> Cycle time includes sweep and retrace time.



**Table 45. Frequency Converter Application (option 083) Cycle Time for Fixed-IF Measurements (ms)<sup>1</sup>**

	Number of Points		
	101	201	401
<b>Stimulus start = 1 GHz, stop = 11 GHz, IFBW = 35 kHz Response = 70 MHz, trace = SC21, cal = SMC_2P</b>			
Hardware Trigger	8.5	17	34
Software Trigger	31	62	124

**Table 46. Data Transfer Time (ms)<sup>a</sup>**

	Number of Points			
	201	401	1601	16,001
<b>SCPI over GPIB (program executed on external PC)</b>				
32-bit floating point	7	12	43	435
64-bit floating point	12	22	84	856
ASCII	64	124	489	5054
<b>SCPI (program executed in the analyzer)</b>				
32-bit floating point	1	2	3	30
64-bit floating point	2	2	4	40
ASCII	29	56	222	2220
<b>COM (program executed in the analyzer)</b>				
32-bit floating point	1	1	1	6
Variant type	1	2	6	68
<b>DCOM over LAN (program executed on external PC)</b>				
32-bit floating point	1	1	2	121
Variant type	3	6	19	939

<sup>a</sup> Typical performance

**Note:** Specifications for Recall & Sweep Speed are not provided for the E836xB/C analyzers.

## Specifications: Front-Panel Jumpers

### Models E8362B/C, E8363B/C, and E8364B/C Option 014

**NOTE:** The standard E8362/3/4A/B has no front-panel jumpers.

**Table 47: Measurement Receiver Inputs (Rcvr A In, Rcvr B In)**

Description	Specification	Supplemental Information
<b>Maximum Input Level</b>		
<b>E8362B/C:</b>		<b>Typical</b>
45 MHz to 500 MHz	--	-15 dBm, typical
500 MHz to 2 GHz	--	-11 dBm, typical
2 GHz to 10 GHz	--	-11 dBm, typical
10 GHz to 20 GHz	--	-11 dBm, typical
<b>E8363B/C:</b>		
45 MHz to 500 MHz	--	-14 dBm, typical
500 MHz to 2 GHz	--	-10 dBm, typical
2 GHz to 10 GHz	--	-10 dBm, typical
10 GHz to 20 GHz	--	-10 dBm, typical
20 GHz to 30 GHz	--	-14.5 dBm, typical
30 GHz to 40 GHz	--	-16.5 dBm, typical
<b>E8364B/C:</b>		
45 MHz to 500 MHz	--	- 14 dBm, typical
500 MHz to 2 GHz	--	- 10 dBm, typical
2 GHz to 10 GHz	--	- 10 dBm, typical
10 GHz to 20 GHz	--	- 10 dBm, typical
20 GHz to 30 GHz	--	- 14.5 dBm, typical
30 GHz to 40 GHz	--	- 16.5 dBm, typical
40 GHz to 45 GHz	--	- 16 dBm, typical
45 GHz to 50 GHz	--	- 15 dBm, typical
<b>Noise Floor</b>		
<b>E8362B/C:</b>		
	<b>10 Hz IF Bandwidth</b>	
45 MHz to 500 MHz	< -109 dBm	--
500 MHz to 2 GHz	< -130 dBm	--
2 GHz to 10 GHz	< -133 dBm	--
10 GHz to 20 GHz	< -135 dBm	--
	<b>1 kHz IF Bandwidth</b>	
45 MHz to 500 MHz	< -89 dBm	--
500 MHz to 2 GHz	< -110 dBm	--
2 GHz to 10 GHz	< -113 dBm	--
10 GHz to 20 GHz	< -115 dBm	--

<b>E8363B/C:</b>		
	<b>10 Hz IF Bandwidth</b>	
45 MHz to 500 MHz	< -127 dBm	--
500 MHz to 2 GHz	< -133 dBm	--
2 GHz to 10 GHz	< -132 dBm	--
10 GHz to 20 GHz	< -134 dBm	--
20 GHz to 40 GHz	< -125 dBm	--
	<b>1 kHz IF Bandwidth</b>	
45 MHz to 500 MHz	< -107 dBm	--
500 MHz to 2 GHz	< -113 dBm	--
2 GHz to 10 GHz	< -112 dBm	--
10 GHz to 20 GHz	< -114 dBm	--
20 GHz to 40 GHz	< -105 dBm	--
<b>E8364B/C:</b>		
	<b>10 Hz IF Bandwidth</b>	--
45 MHz to 500 MHz	< - 127 dBm	--
500 MHz to 2 GHz	< - 133 dBm	--
2 GHz to 10 GHz	< - 132 dBm	--
10 GHz to 20 GHz	< - 134 dBm	--
20 GHz to 40 GHz	< - 125 dBm	--
40 GHz to 50 GHz	< - 123 dBm	--
	<b>1 kHz IF Bandwidth</b>	
45 MHz to 500 MHz	< -107 dBm	--
500 MHz to 2 GHz	< -113 dBm	--
2 GHz to 10 GHz	< -112 dBm	--
10 GHz to 20 GHz	< -114 dBm	--
20 GHz to 40 GHz	< -105 dBm	--
40 GHz to 50 GHz	< -103 dBm	--
<b>Damage Level</b>		
E8362B/C	--	+ 15 dBm
E8363B/C	--	+ 15 dBm
E8364B/C	--	+ 15 dBm
<b>Maximum DC Level</b>		
E8362B/C	--	+ 15 V
E8363B/C	--	+ 15 V
E8364B/C	--	+ 15 V

**Table 48: Reference Receiver Inputs (Rcvr R1, Rcvr R2)**

Description	Specification	Supplemental Information
<b>Minimum Input Level</b>		
E8362B/C, E8363B/C, E8364B/C	--	-25 dBm, typical
<b>Maximum Input Level</b>		
<b>E8362B/C:</b>		
45 MHz to 500 MHz	--	-15 dBm, typical
500 MHz to 2 GHz	--	-11 dBm, typical
2 GHz to 10 GHz	--	-11 dBm, typical
10 GHz to 20 GHz	--	-11 dBm, typical
<b>E8363B/C:</b>		
45 MHz to 500 MHz	--	-14 dBm, typical
500 MHz to 2 GHz	--	-10 dBm, typical
2 GHz to 10 GHz	--	-10 dBm, typical
10 GHz to 20 GHz	--	-9.5 dBm, typical
20 GHz to 30 GHz	--	-14 dBm, typical
30 GHz to 40 GHz	--	-15.5 dBm, typical
<b>E8364B/C:</b>		
45 MHz to 500 MHz	--	- 14 dBm, typical
500 MHz to 2 GHz	--	- 10 dBm, typical
2 GHz to 10 GHz	--	- 10 dBm, typical
10 GHz to 20 GHz	--	- 9.5 dBm, typical
20 GHz to 30 GHz	--	- 14 dBm, typical
30 GHz to 40 GHz	--	- 15.5 dBm, typical
40 GHz to 45 GHz	--	- 14 dBm, typical
45 GHz to 50 GHz	--	- 15 dBm, typical
<b>Damage Level</b>		
E8362B/C	--	+ 15 dBm, typical
E8363B/C	--	+ 15 dBm, typical
E8364B/C	--	+ 15 dBm, typical
<b>Maximum DC Level</b>		
E8362B/C	--	+/- 15 V, typical
E8363B/C	--	+/- 15 V, typical
E8364B/C	--	+/- 15 V, typical

**Table 49: Reference Outputs (Reference 1 Source Out, Reference 2 Source Out)**

Description	Specification	Supplemental Information
<b>Maximum Output Level</b>		
<b>E8362B/C:</b>		
45 MHz to 500 MHz	--	-24 dBm, typical
500 MHz to 2 GHz	--	-23 dBm, typical
2 GHz to 10 GHz	--	-23 dBm, typical
10 GHz to 20 GHz	--	-26 dBm, typical
<b>E8363B/C:</b>		
45 MHz to 500 MHz	--	-11.5 dBm, typical
500 MHz to 2 GHz	--	-10.5 dBm, typical
2 GHz to 10 GHz	--	-11 dBm, typical
10 GHz to 20 GHz	--	-11 dBm, typical
20 GHz to 30 GHz	--	-11 dBm, typical
30 GHz to 40 GHz	--	-11 dBm, typical
<b>E8364B/C:</b>		
45 MHz to 500 MHz	--	- 11.5 dBm, typical
500 MHz to 2 GHz	--	- 10.5 dBm, typical
2 GHz to 10 GHz	--	- 11 dBm, typical
10 GHz to 20 GHz	--	- 11 dBm, typical
20 GHz to 30 GHz	--	- 11 dBm, typical
30 GHz to 40 GHz	--	- 11 dBm, typical
40 GHz to 45 GHz	--	- 11 dBm, typical
45 GHz to 50 GHz	--	- 15 dBm, typical
<b>Damage Level</b>		
E8362B/C	--	+ 20 dBm, typical
E8363B/C	--	+ 20 dBm, typical
E8364B/C	--	+ 20 dBm, typical
<b>Maximum DC Level</b>		
E8362B/C	--	+/- 15 V, typical
E8363B/C	--	+/- 15 V, typical
E8364B/C	--	+/- 15 V, typical

**Table 50: Source Outputs (Port 1 Source Out, Port 2 Source Out)**

Description	Specification	Supplemental Information
<b>Maximum Output Level</b>		
<b>E8362B/C, Option 014:</b>		
45 MHz to 500 MHz	--	6 dBm, typical
500 MHz to 2 GHz	--	7 dBm, typical
2 GHz to 10 GHz	--	7 dBm, typical
10 GHz to 20 GHz	--	4 dBm, typical
<b>E8362B/C, Option 014 and UNL:</b>		
45 MHz to 500 MHz	--	4 dBm, typical
500 MHz to 2 GHz	--	5 dBm, typical
2 GHz to 10 GHz	--	5 dBm, typical
10 GHz to 20 GHz	--	2 dBm, typical
<b>E8363B/C, Option 014:</b>		
45 MHz to 500 MHz	--	5.5 dBm, typical
500 MHz to 2 GHz	--	6.5 dBm, typical
2 GHz to 10 GHz	--	6.5 dBm, typical
10 GHz to 20 GHz	--	4 dBm, typical
20 GHz to 30 GHz	--	10 dBm, typical
30 GHz to 40 GHz	--	-2 dBm, typical
<b>E8363B/C, Option 014 and UNL:</b>		
45 MHz to 500 MHz	--	3.5 dBm, typical
500 MHz to 2 GHz	--	5 dBm, typical
2 GHz to 10 GHz	--	5 dBm, typical
10 GHz to 20 GHz	--	3.5 dBm, typical
20 GHz to 30 GHz	--	0 dBm, typical
30 GHz to 40 GHz	--	-2.5 dBm, typical
<b>E8364B/C, Option 014:</b>		
45 MHz to 500 MHz	--	5.5 dBm, typical
500 MHz to 2 GHz	--	6.5 dBm, typical
2 GHz to 10 GHz	--	6.5 dBm, typical
10 GHz to 20 GHz	--	4 dBm, typical
20 GHz to 30 GHz	--	1 dBm, typical
30 GHz to 40 GHz	--	-2 dBm, typical
40 GHz to 45 GHz	--	-3 dBm, typical
45 GHz to 50 GHz	--	-7.5 dBm, typical

<b>E8364B/C, Option 014 and UNL:</b>		
45 MHz to 500 MHz	--	3.5 dBm, typical
500 MHz to 2 GHz	--	5 dBm, typical
2 GHz to 10 GHz	--	5 dBm, typical
10 GHz to 20 GHz	--	3.5 dBm, typical
20 GHz to 30 GHz	--	0 dBm, typical
30 GHz to 40 GHz	--	-2.5 dBm, typical
40 GHz to 45 GHz	--	-5 dBm, typical
45 GHz to 50 GHz	--	-10 dBm, typical
<b>Damage Level</b>		
E8362B/C	--	20 dBm, typical
E8363B/C	--	20 dBm, typical
E8364B/C	--	20 dBm, typical
<b>Maximum DC Level</b>		
E8362B/C	--	0 V, typical
E8363B/C	--	0 V, typical
E8364B/C	--	0 V, typical

**Table 51: Coupler Inputs (Port 1 Cplr Thru, Port 2 Cplr Thru)**

Description	Specification	Supplemental Information
<b>Insertion Loss to Test Port</b>		
<b>E8362B/C, Option 014:</b>		
45 MHz to 500 MHz	--	0.5 dB, typical
500 MHz to 2 GHz	--	1.5 dB, typical
2 GHz to 10 GHz	--	1.5 dB, typical
10 GHz to 20 GHz	--	1.5 dB, typical
<b>E8362B/C, Option 014 and UNL:</b>		
45 MHz to 500 MHz	--	1 dB, typical
500 MHz to 2 GHz	--	2 dB, typical
2 GHz to 10 GHz	--	2 dB, typical
10 GHz to 20 GHz	--	2 dB, typical
<b>E8363B/C, Option 014:</b>		
45 MHz to 500 MHz	--	0.5 dB, typical
500 MHz to 2 GHz	--	0.5 dB, typical
2 GHz to 10 GHz	--	1.5 dB, typical
10 GHz to 20 GHz	--	2 dB, typical
20 GHz to 30 GHz	--	3 dB, typical
30 GHz to 40 GHz	--	3.5 dB, typical
<b>E8363B/C, Option 014 and UNL:</b>		
45 MHz to 500 MHz	--	0.5 dB, typical
500 MHz to 2 GHz	--	1 dB, typical
2 GHz to 10 GHz	--	2 dB, typical
10 GHz to 20 GHz	--	3 dB, typical
20 GHz to 30 GHz	--	4 dB, typical
30 GHz to 40 GHz	--	5 dB, typical
<b>E8364B/C, Option 014:</b>		
45 MHz to 500 MHz	--	0.5 dB, typical
500 MHz to 2 GHz	--	0.5 dB, typical
2 GHz to 10 GHz	--	1.5 dB, typical
10 GHz to 20 GHz	--	2 dB, typical
20 GHz to 30 GHz	--	3 dB, typical
30 GHz to 40 GHz	--	3.5 dB, typical
40 GHz to 45 GHz	--	3.5 dB, typical
45 GHz to 50 GHz	--	4 dB, typical



<b>E8364B/C, Option 014 and UNL:</b>		
45 MHz to 500 MHz	--	0.5 dB, typical
500 MHz to 2 GHz	--	1 dB, typical
2 GHz to 10 GHz	--	2 dB, typical
10 GHz to 20 GHz	--	3 dB, typical
20 GHz to 30 GHz	--	4 dB, typical
30 GHz to 40 GHz	--	5 dB, typical
40 GHz to 45 GHz	--	5.5 dB, typical
45 GHz to 50 GHz	--	6 dB, typical
<b>Damage Level</b>		
E8362B/C	--	+ 30 dBm, typical
E8363B/C	--	+ 30 dBm, typical
E8364B/C	--	+ 30 dBm, typical
<b>Maximum DC Level</b>		
E8362B/C	--	+/- 40 V, typical
E8363B/C	--	+/- 40 V, typical
E8364B/C	--	+/- 40 V, typical

**Table 52: Coupler Outputs (Port 1 Cplr Arm, Port 2 Cplr Arm)**

<b>Description</b>	<b>Specification</b>	<b>Supplemental Information</b>
<b>Damage Level</b>		
E8362B/C	--	+ 30 dBm, typical
E8363B/C	--	+ 30 dBm, typical
E8364B/C	--	+ 30 dBm, typical
<b>Maximum DC Level</b>		
E8362B/C	--	+/- 7 V, typical
E8363B/C	--	+/- 7 V, typical
E8364B/C	--	+/- 7 V, typical

# Test Set Block Diagrams

E836xB/C - Standard Configuration and Standard Power Range

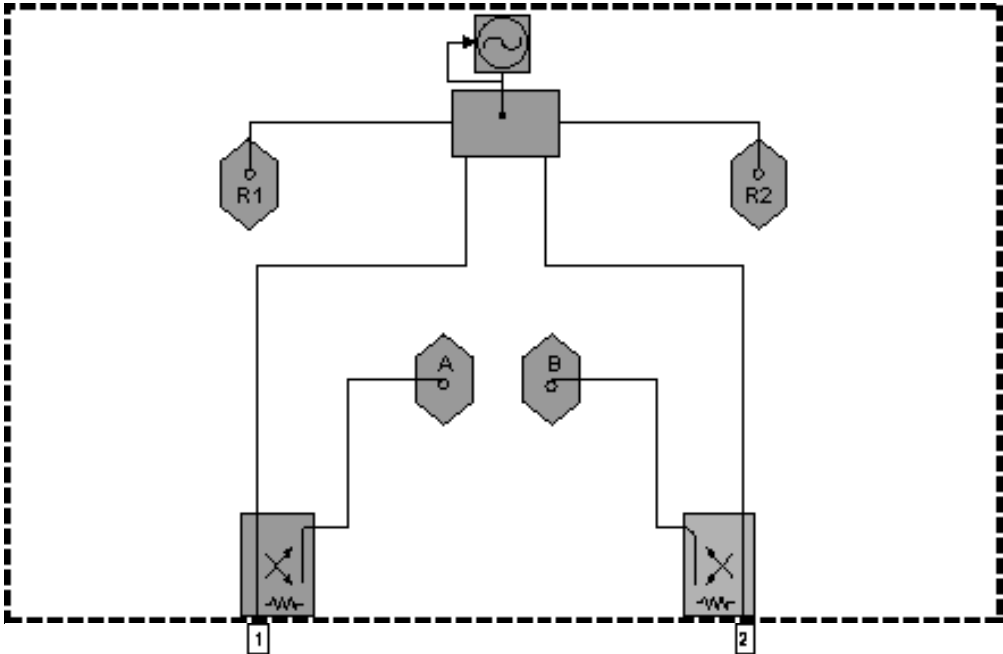

E836xB/C - Option UNL Standard Configuration with Extended Power Range and Bias - Tees

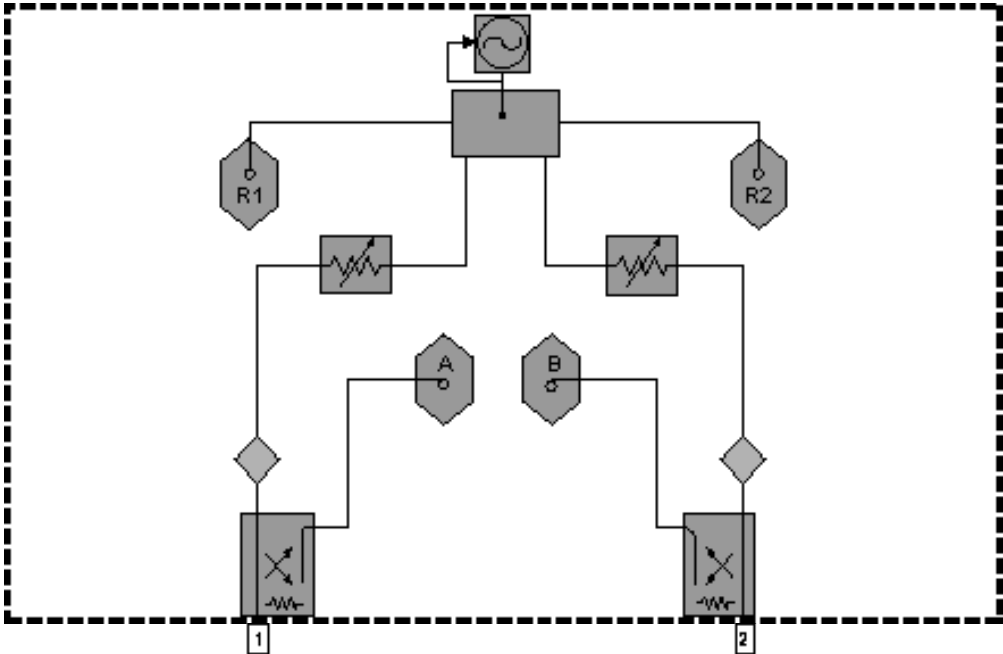

E836xB/C - Option UNL Standard Configuration with Extended Power Range and Bias - Tees, and Option 016, Receiver Attenuators

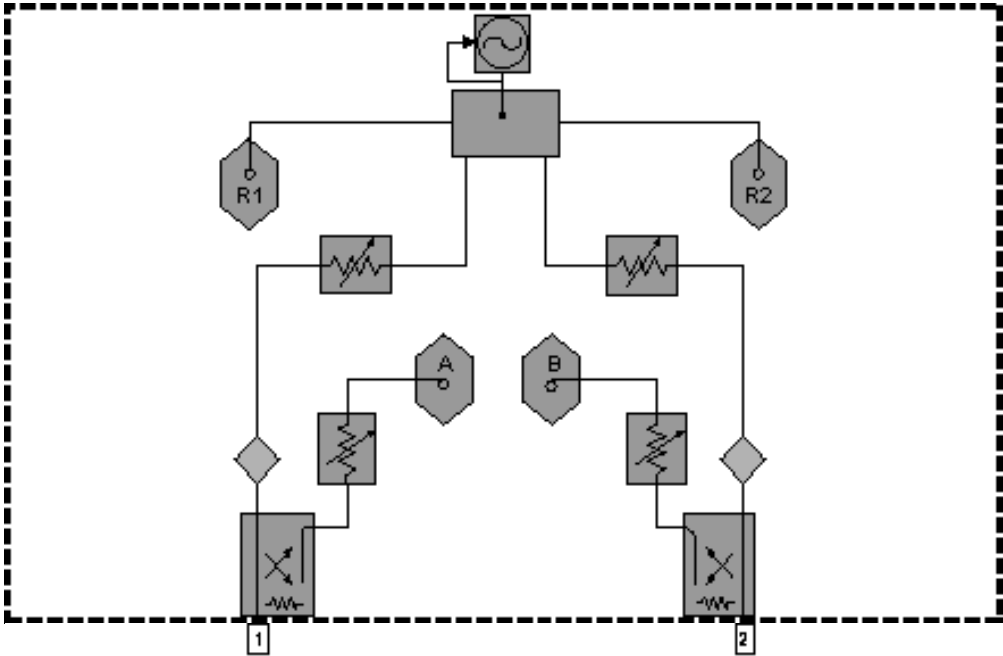

## Test Set with Option 014 Block Diagrams

E836xB/C - Option 014 Configurable Test Set and Standard Power Range

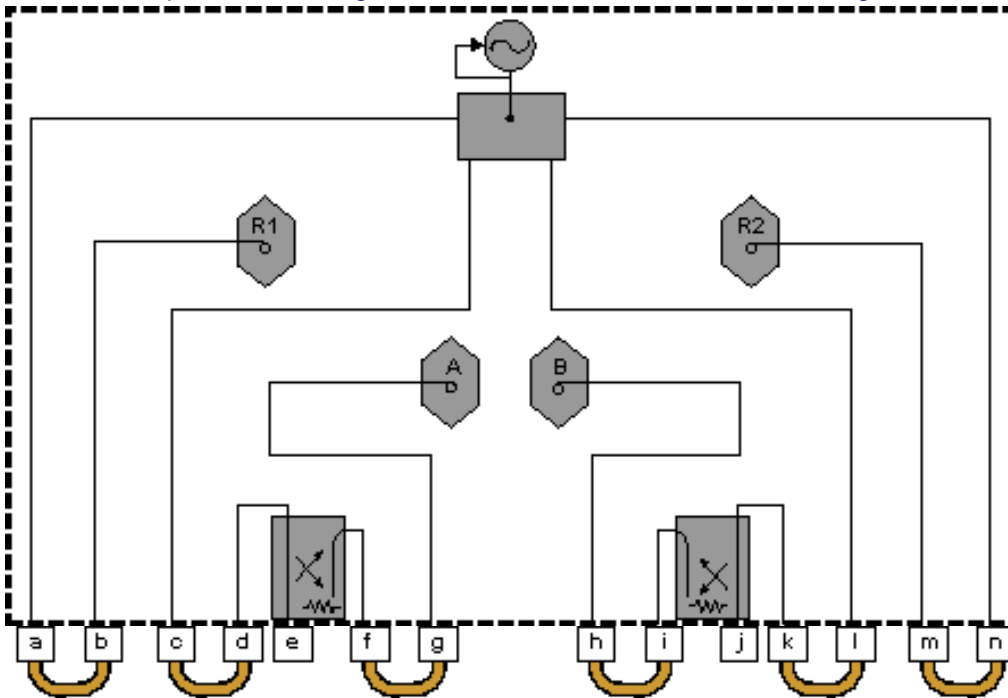

Item	Description	Item	Description
a	SOURCE OUT	h	RCVR B IN
b	RCVR R1 IN	i	CPLR ARM
c	SOURCE OUT	j	PORT 2
d	CPLR THRU	k	CPLR THRU
e	PORT 1	l	SOURCE OUT
f	CPLR ARM	m	RCVR R2 IN
g	RCVR A IN	n	SOURCE OUT

E836xB/C - Option 014 Configurable Test Set and Standard Power Range, and Option 081 Reference Channel Transfer Switch

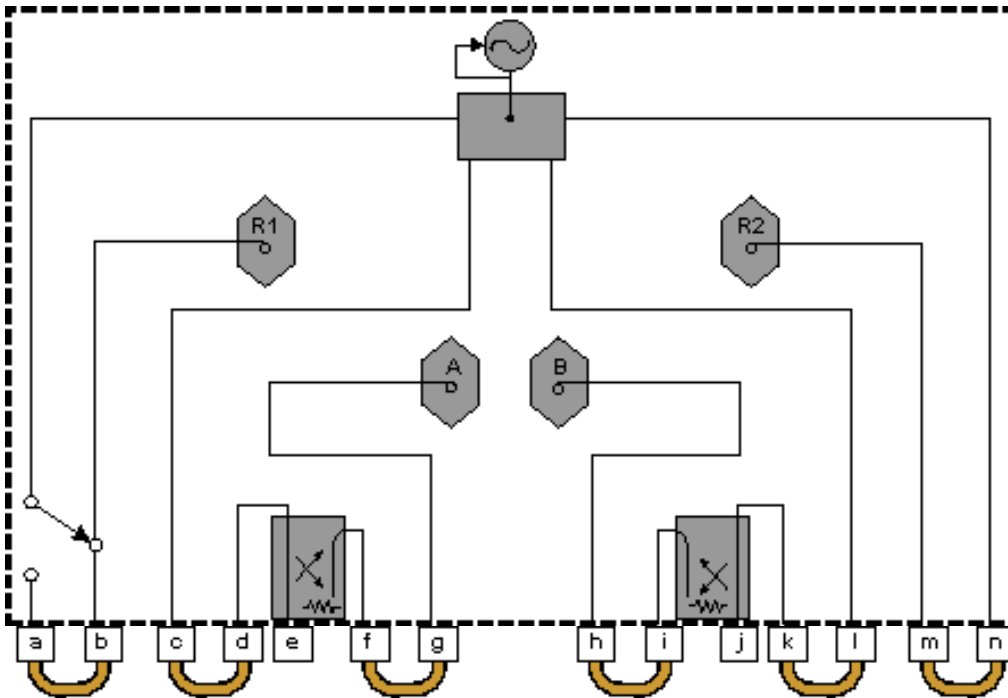

Item	Description	Item	Description
a	SOURCE OUT	h	RCVR B IN
b	RCVR R1 IN	i	CPLR ARM
c	SOURCE OUT	j	PORT 2
d	CPLR THRU	k	CPLR THRU
e	PORT 1	l	SOURCE OUT
f	CPLR ARM	m	RCVR R2 IN
g	RCVR A IN	n	SOURCE OUT

E836xB/C - Option 014 Configurable Test Set, and Option UNL Extended Power Range and Bias - Tees

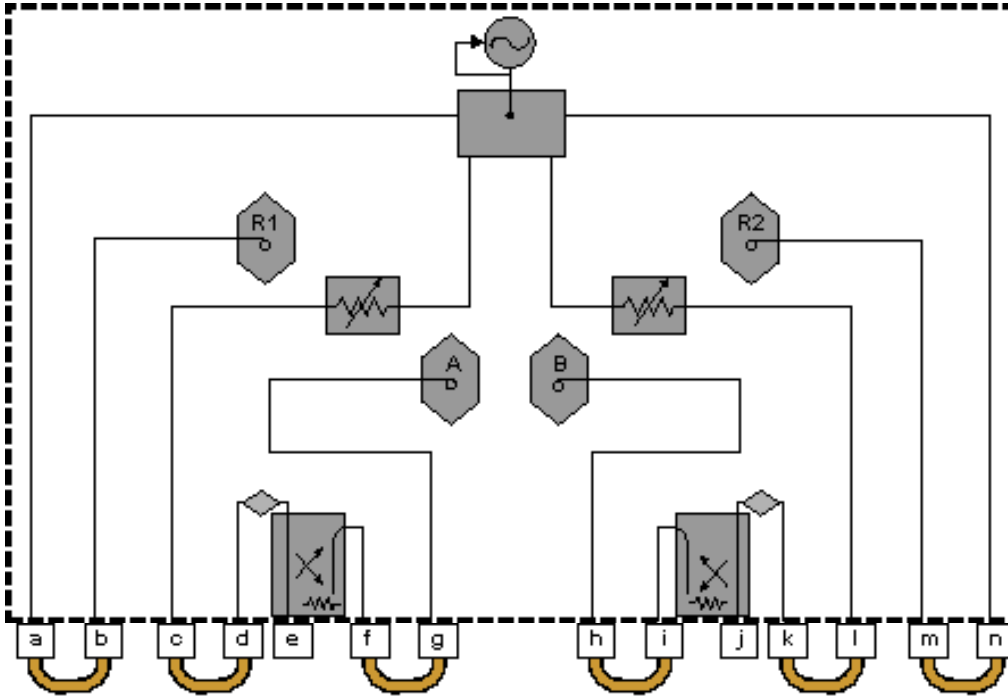

Item	Description	Item	Description
a	SOURCE OUT	h	RCVR B IN
b	RCVR R1 IN	i	CPLR ARM
c	SOURCE OUT	j	PORT 2
d	CPLR THRU	k	CPLR THRU
e	PORT 1	l	SOURCE OUT
f	CPLR ARM	m	RCVR R2 IN
g	RCVR A IN	n	SOURCE OUT

E836xB/C - Option 014 Configurable Test Set, and Option UNL Extended Power Range and Bias - Tees, and Option 081 Reference Channel Transfer Switch

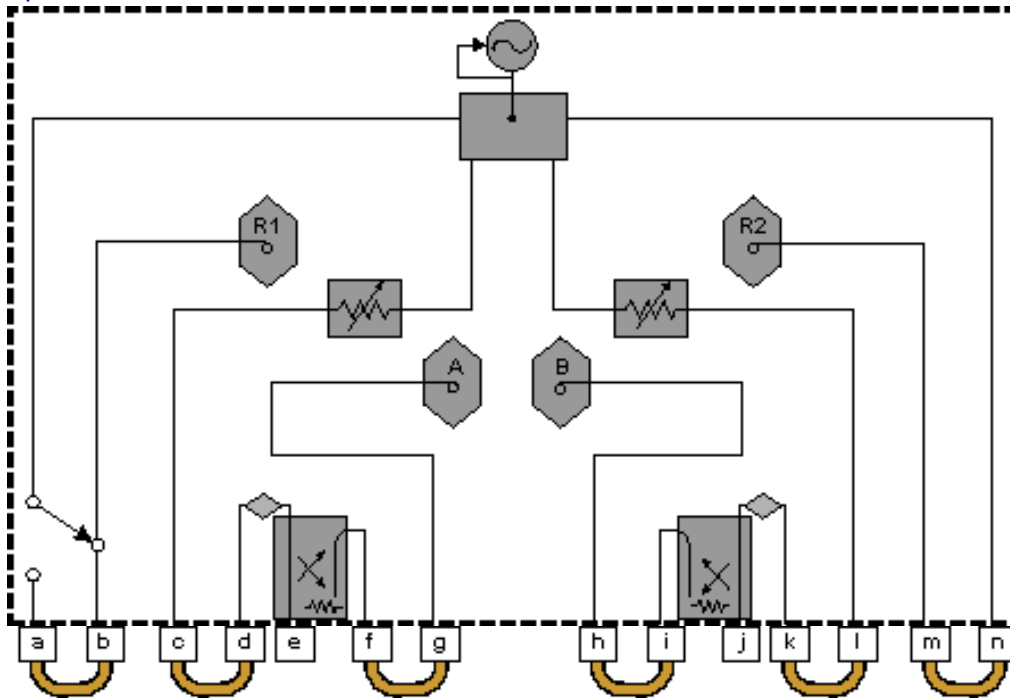

Item	Description	Item	Description
a	SOURCE OUT	h	RCVR B IN
b	RCVR R1 IN	i	CPLR ARM
c	SOURCE OUT	j	PORT 2
d	CPLR THRU	k	CPLR THRU
e	PORT 1	l	SOURCE OUT
f	CPLR ARM	m	RCVR R2 IN
g	RCVR A IN	n	SOURCE OUT

E836xB/C - Option 014 Configurable Test Set and Option UNL, Extended Power Range and Bias - Tees and Option 016 Receiver Attenuators

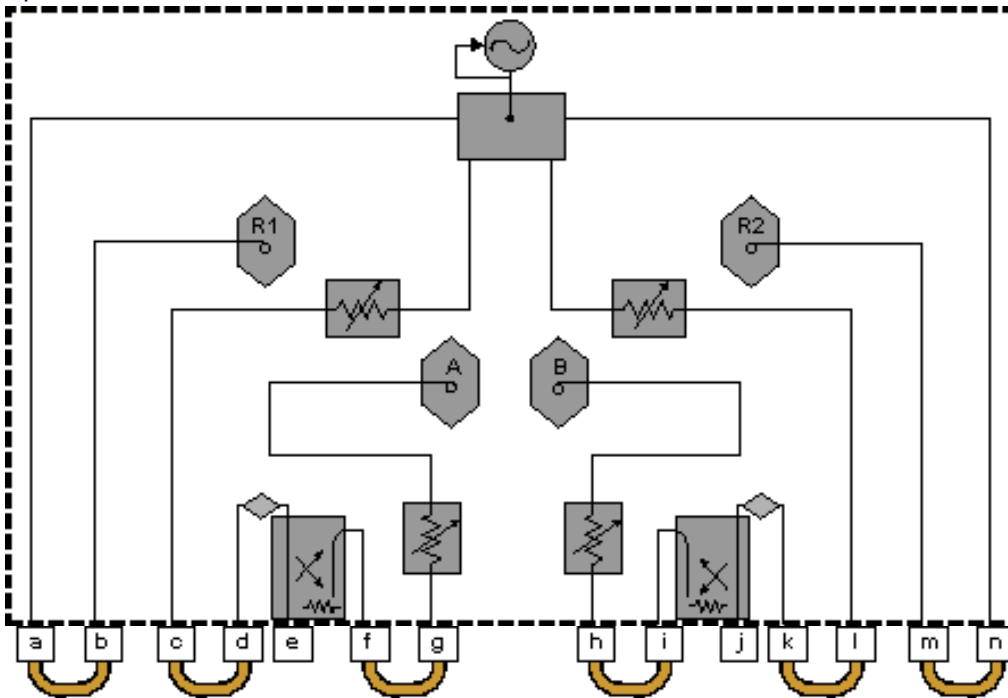

Item	Description	Item	Description
a	SOURCE OUT	h	RCVR B IN
b	RCVR R1 IN	i	CPLR ARM
c	SOURCE OUT	j	PORT 2
d	CPLR THRU	k	CPLR THRU
e	PORT 1	l	SOURCE OUT
f	CPLR ARM	m	RCVR R2 IN
g	RCVR A IN	n	SOURCE OUT



E836xB/C - Option 014 Configurable Test Set, and Option UNL Extended Power Range and Bias - Tees, and Option 016 Receiver Attenuators, and Option 081 Reference Channel Transfer Switch

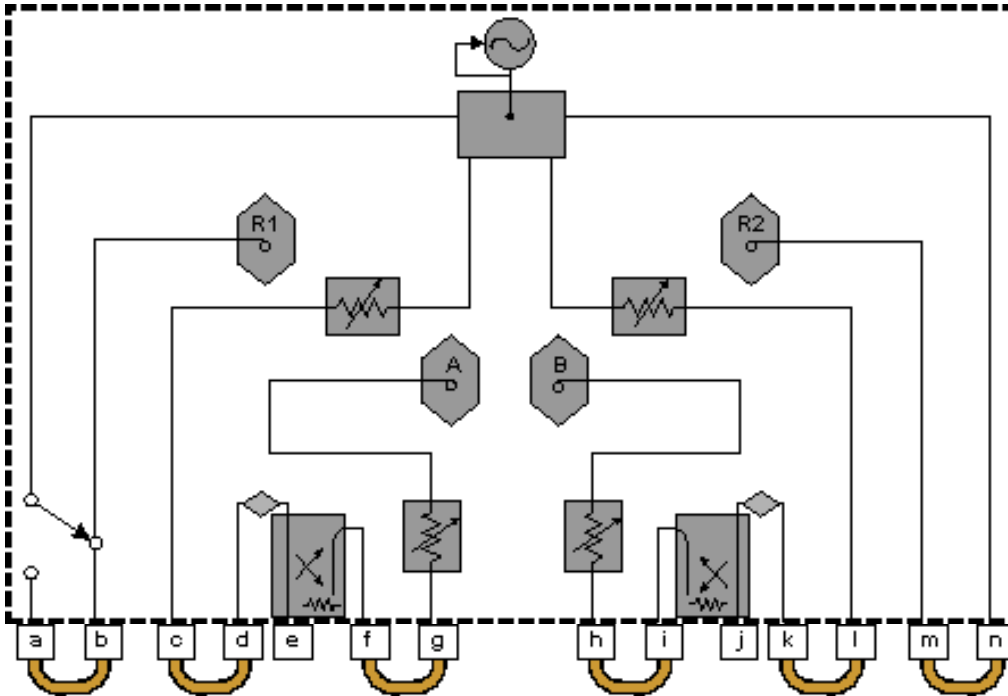

Item	Description	Item	Description
a	SOURCE OUT	h	RCVR B IN
b	RCVR R1 IN	i	CPLR ARM
c	SOURCE OUT	j	PORT 2
d	CPLR THRU	k	CPLR THRU
e	PORT 1	l	SOURCE OUT
f	CPLR ARM	m	RCVR R2 IN
g	RCVR A IN	n	SOURCE OUT