

Agilent
RF Network Analyzers
PNA Series
Technical Specifications

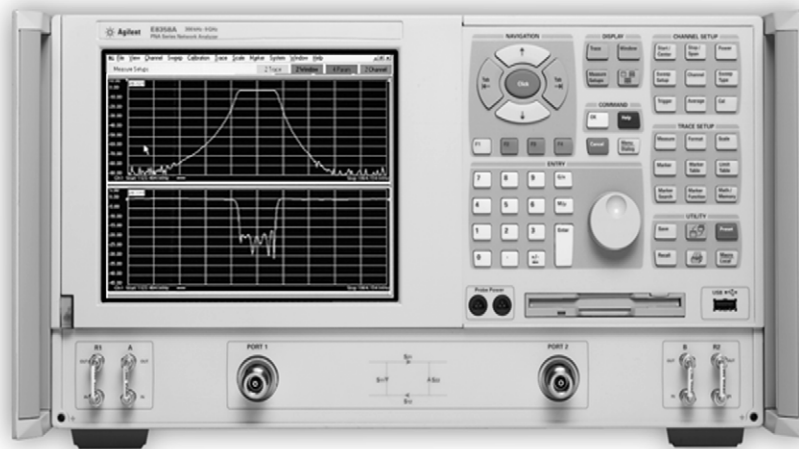

This document describes the performance and features of Agilent Technologies PNA Series RF network analyzers:

Agilent E8356A S-parameter vector network analyzer, 300 kHz to 3 GHz

Agilent E8357A S-parameter vector network analyzer, 300 kHz to 6 GHz

Agilent E8358A S-parameter vector network analyzer, 300 kHz to 9 GHz



Some definitions

All specifications and characteristics apply over a $25\text{ }^{\circ}\text{C} \pm 5\text{ }^{\circ}\text{C}$ range (unless otherwise stated) and 90 minutes after the instrument has been turned on.

Specification (spec.): Warranted performance. Specifications include guardbands to account for the expected statistical performance distribution, measurement uncertainties, and changes in performance due to environmental conditions.

Characteristic (char.): A performance parameter that the product is expected to meet before it leaves the factory, but that is not verified in the field and is not covered by the product warranty. A characteristic includes the same guardbands as a specification.

Typical (typ.): Expected performance of an average unit which does not include guardbands. It is not covered by the product warranty.

Nominal (nom.): A general, descriptive term that does not imply a level of performance. It is not covered by the product warranty.

Calibration: The process of measuring known standards to characterize a network analyzer's systematic (repeatable) errors.

Corrected (residual): Indicates performance after error correction (calibration). It is determined by the quality of calibration standards and how well “known” they are, plus system repeatability, stability, and noise.

Uncorrected (raw): Indicates instrument performance without error correction. The uncorrected performance affects the stability of a calibration.

Standard: When referring to the analyzer, this includes all options unless noted otherwise.

Corrected system performance

The specifications in this section apply for measurements made with the PNA Series analyzer with the following conditions:

- 10 Hz IF bandwidth
- No averaging applied to data
- Environmental temperature of 25 °C ±5 °C, with less than 1 °C deviation from the calibration temperature
- Isolation calibration not omitted

System dynamic range

Description	Specification (dB)	Characteristic (dB)
Dynamic Range^a (at test port)		
300 kHz to 25 MHz ^b	125	
25 MHz to 3 GHz ^b	128	
3 GHz to 6 GHz	118	
6 GHz to 9 GHz	113	
Dynamic Range^c (at receiver input)		
300 kHz to 25 MHz ^d		140
25 MHz to 3 GHz ^d		143
3 GHz to 6 GHz		133
6 GHz to 9 GHz		128

- The test port dynamic range is calculated as the difference between the test port rms noise floor and the source maximum output power. The effective dynamic range must take measurement uncertainties and interfering signals into account.
- May be limited to 100 dB at particular frequencies below 750 MHz due to spurious receiver residuals.
- The receiver input dynamic range is calculated as the difference between the receiver rms noise floor and the source maximum output power. The effective dynamic range must take measurement uncertainties and interfering signals into account. This set-up should only be used when the receiver input will never exceed its damage level. When the analyzer is in segment sweep mode, frequency segments can be defined with a higher power level when the extended dynamic range is required (i.e. the portion of the device's response with high insertion loss), and reduced power when receiver damage may occur (i.e. the portion of the device's response with low insertion loss).
- May be limited to 115 dB at particular frequencies below 750 MHz due to spurious receiver residuals.

Corrected system performance with type-N connectors

Applies to PNA Series analyzer, 85032F (Type-N, 50 Ω) calibration kit, and N6314A test port cable using full two-port error correction.

Description	Specification (dB)			
	300 kHz to 1.3 GHz	1.3 GHz to 3 GHz	3 to 6 GHz	6 to 9 GHz
Directivity	49	46	40	38
Source match	41	40	36	35
Load match	49	46	40	38
Reflection tracking	±0.011	±0.021	±0.032	±0.054
Transmission tracking	±0.011	±0.018	±0.040	±0.049

Transmission uncertainty

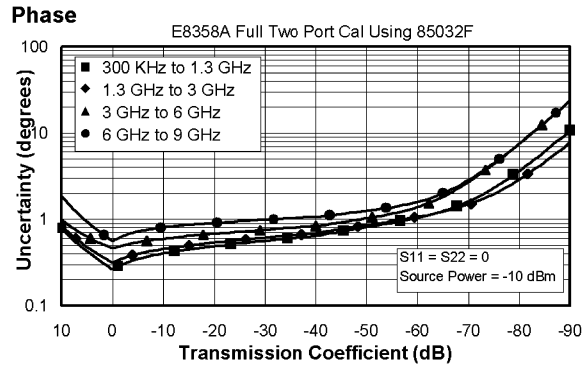
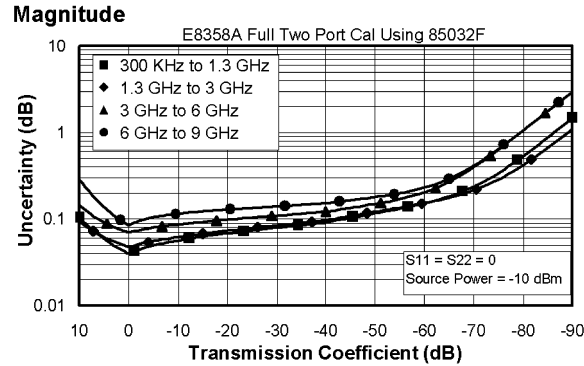

Reflection uncertainty

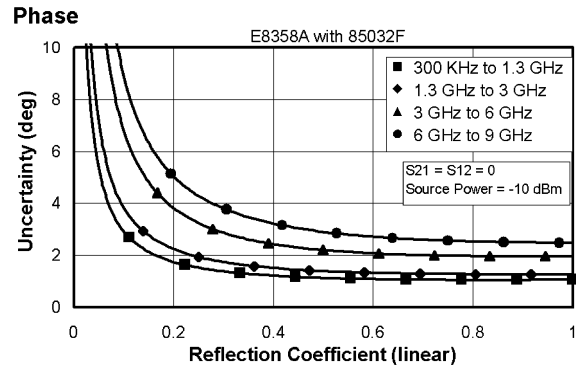
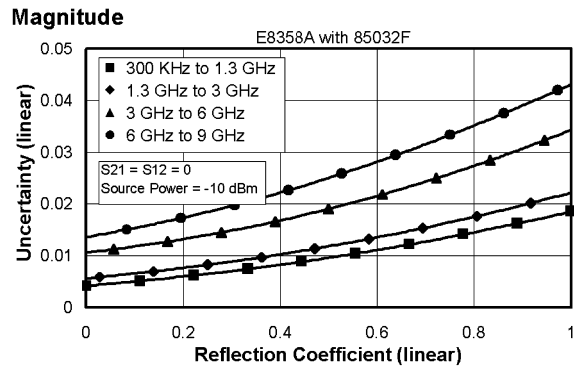

Corrected system performance with type-N connectors

Applies to PNA Series analyzer, 85092B (Type-N, 50 Ω) Electronic calibration (ECal) module, and N6314A test port cable using full two-port error correction.

Description	Specification (dB)			
	300 kHz to 1.3 GHz	1.3 GHz to 3 GHz	3 to 6 GHz	6 to 9 GHz
Directivity	52	54	52	47
Source match	45	44	41	37
Load match	47	47	44	39
Reflection tracking	±0.037	±0.037	±0.068	±0.100
Transmission tracking	±0.060	±0.055	±0.090	±0.140

Transmission uncertainty

Magnitude

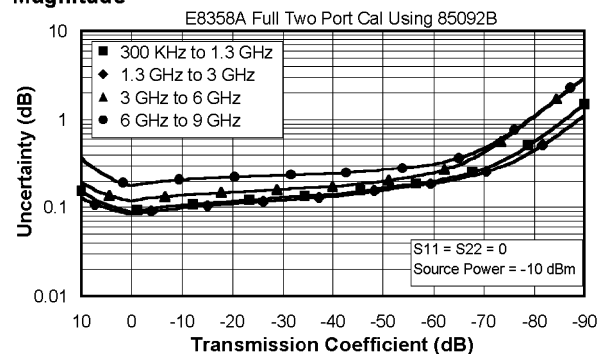

Phase

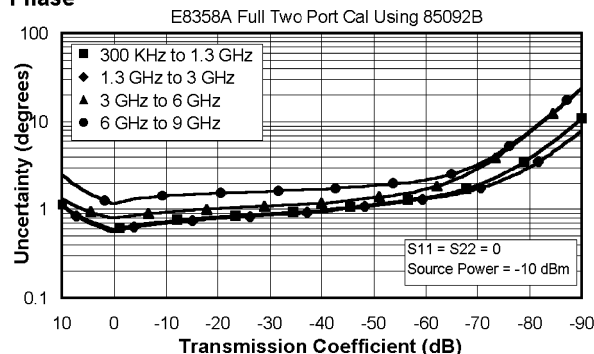

Reflection uncertainty

Magnitude

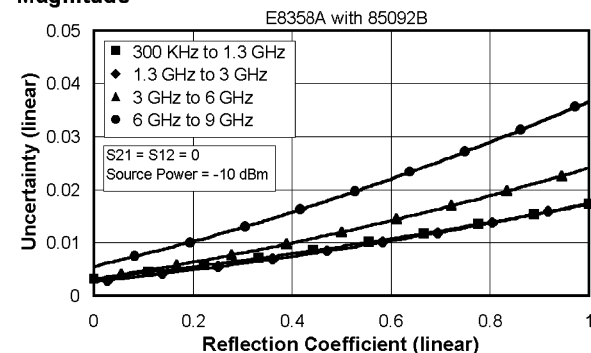

Phase

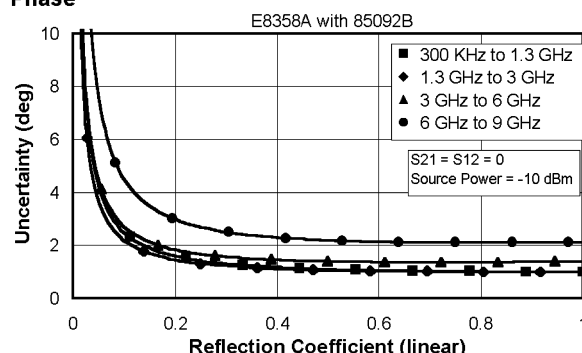

Corrected system performance with type-N connectors

Applies to PNA series analyzer with Option 015, 85032F (Type-N, 50 Ω) calibration kit, and N6314A test port cable using full two-port error correction.

Description	Specification (dB)			
	300 kHz to 1.3 GHz	1.3 GHz to 3 GHz	3 to 6 GHz	6 to 9 GHz
Directivity	49	46	40	38
Source match	41	40	36	35
Load match	49	46	40	38
Reflection tracking	±0.011	±0.021	±0.032	±0.054
Transmission tracking	±0.011	±0.023	±0.050	±0.062

Transmission uncertainty

Magnitude

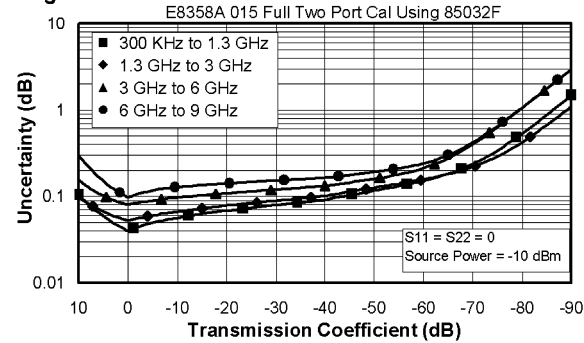

Phase

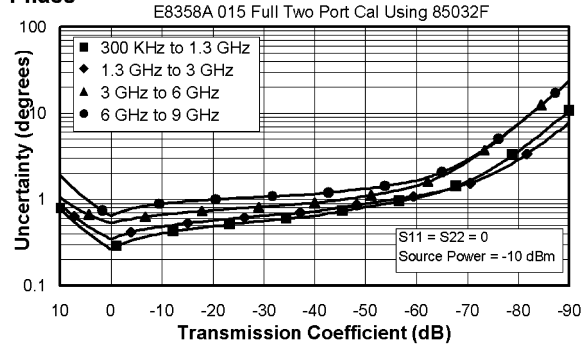

Reflection uncertainty

Magnitude

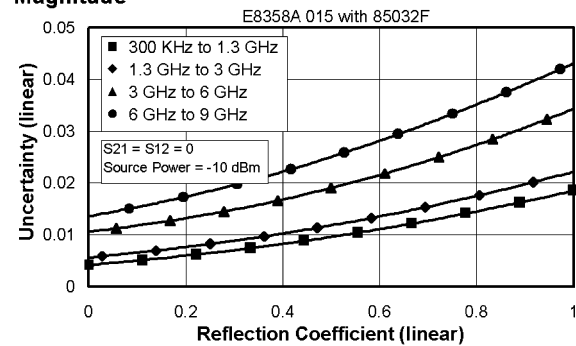

Phase

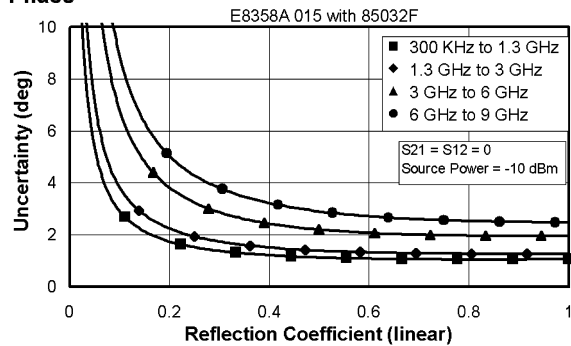

Corrected system performance with 3.5 mm connectors

Applies to PNA Series analyzer, 85033E (3.5 mm, 50 Ω) calibration kit, and N6314A test port cable using full two-port error correction.

Description	Specification (dB)			
	300 kHz to 1.3 GHz	1.3 GHz to 3 GHz	3 to 6 GHz	6 to 9 GHz
Directivity	46	44	38	38
Source match	43	40	37	36
Load match	46	44	38	38
Reflection tracking	±0.006	±0.007	±0.009	±0.010
Transmission tracking	±0.010	±0.020	±0.041	±0.046

Transmission uncertainty

Magnitude

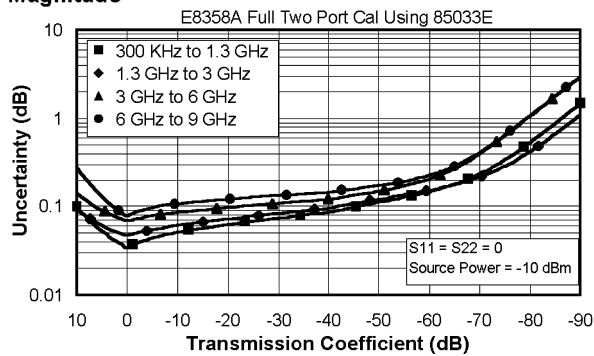

Phase

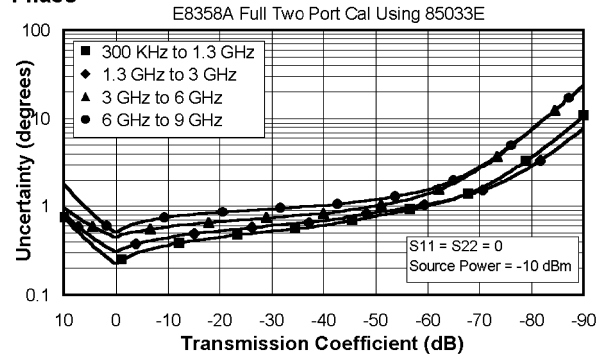

Reflection uncertainty

Magnitude

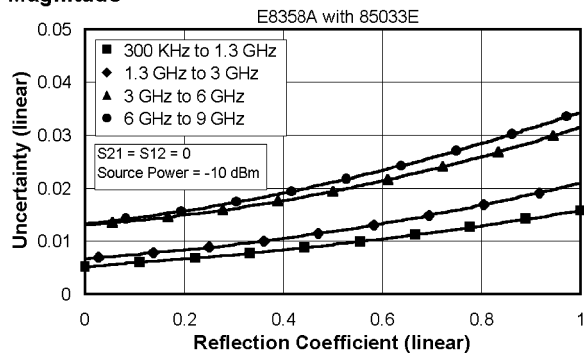

Phase

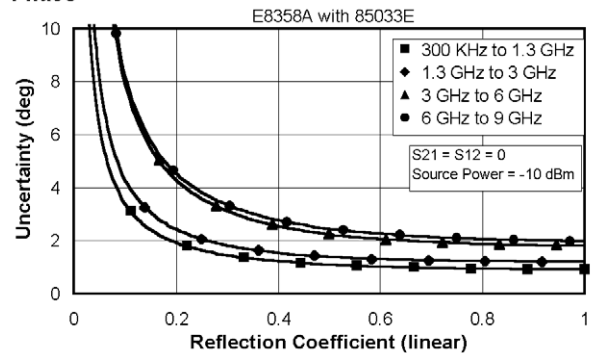

Corrected system performance with 3.5mm connectors

Applies to PNA Series analyzer, 85093B (3.5mm, 50 Ω) Electronic calibration (ECal) module, and N6314A test port cable using full two-port error correction.

Description	Specification (dB)			
	300 kHz to 1.3 GHz	1.3 GHz to 3 GHz	3 to 6 GHz	6 to 9 GHz
Directivity	50	52	51	45
Source match	45	43	40	37
Load match	47	47	44	39
Reflection tracking	±0.043	±0.043	±0.055	±0.100
Transmission tracking	±0.050	±0.045	±0.085	±0.140

Transmission uncertainty

Magnitude

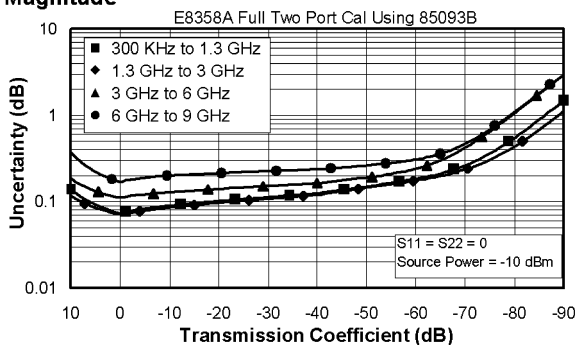

Phase

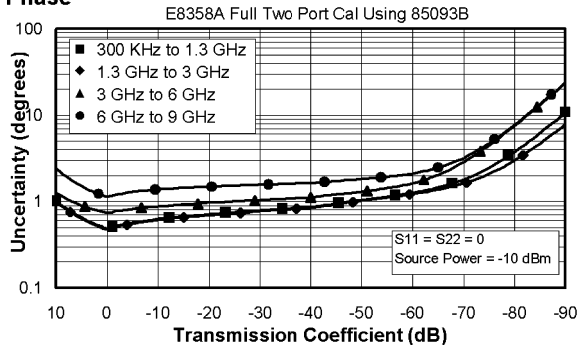

Reflection uncertainty

Magnitude

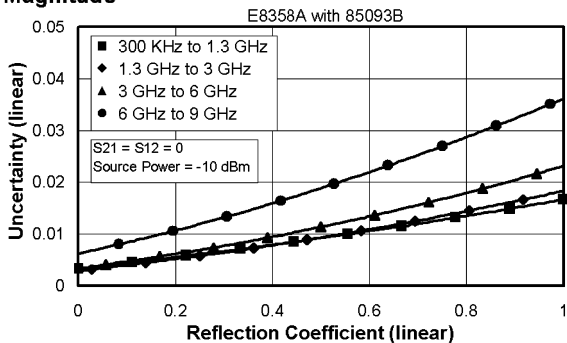

Phase

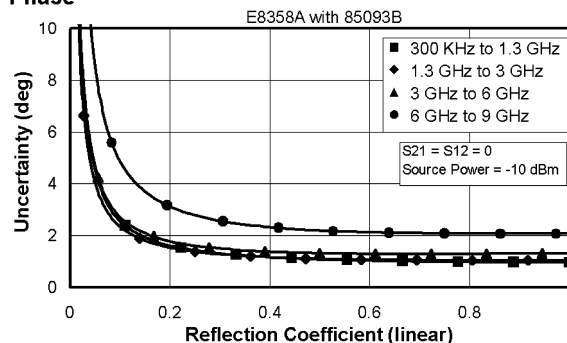

Uncorrected system performance

Description	Specification (dB)				
	300 kHz to 1 MHz	1 MHz to 1.3 GHz	1.3 GHz to 3 GHz	3 to 6 GHz	6 to 9 GHz
Directivity	30	33	27	20	13
Source match	20	20	17	15	14
Source match (opt. 015)	20	20	15	13	12
Load match	20	20	17	15	15
Load match (opt. 015)	20	20	15	13	13
Reflection tracking	±1.5	±1.5	±1.5	±2.5	±3.0
Transmission tracking	±1.5	±1.5	±1.5	±2.5	±3.0

Test port output^a

Description	Specification	Supplemental information
Frequency range		
E8356A	300 kHz to 3.0 GHz	
E8357A	300 kHz to 6.0 GHz	
E8358A	300 kHz to 9.0 GHz	
Frequency resolution	1 Hz	
CW accuracy	±1 ppm	
Frequency stability		±1 ppm, 0° to 40 °C, typical ±0.2 ppm/year, typical
Power level accuracy		Variation from 0 dBm in power range 0 ±1.5 dB below 10 MHz
300 kHz to 6 GHz	±1.0 dB	
6 GHz to 9 GHz	±2.0 dB	
Power level linearity		
300 kHz to 9 GHz	±0.3 dB	-15 to +5 dBm
300 kHz to 1 MHz	±1.0 dB	+5 to +10 dBm
1 MHz to 6 GHz	±0.5 dB	+5 to +10 dBm
Power level range^b		
300 kHz to 6 GHz	-85 to +10 dBm	
6 GHz to 9 GHz	-85 to + 5 dBm	
Power sweep range		
300 kHz to 6 GHz	25 dB	
6 GHz to 9 GHz	20 dB	
Power level resolution	0.01 dB	
Harmonics (2nd or 3rd)		
at max output power		< -25 dBc, characteristic
at 0 dBm output		< -35 dBc, typical
at -10 dBm output		< -38 dBc, typical, in power range 0
Non-harmonic spurious		
at max output power		-30 dBc, typical for offset freq > 1 kHz
at -10 dBm output		-50 dBc, typical for offset freq > 1 kHz

a. Source output performance on port 1 only. Port 2 output performance is a characteristic.

b. Power to which the source can be set and phase lock is assured.

Test port input

Description	Specification	Supplemental information
Test port noise floor^a		
300 kHz to 25 MHz ^b		
10 Hz IF bandwidth	≤ -115 dBm	
1 kHz IF bandwidth	≤ -95 dBm	
25 MHz to 3 GHz ^b		
10 Hz IF bandwidth	≤ -118 dBm	
1 kHz IF bandwidth	≤ -98 dBm	
3 GHz to 9 GHz		
10 Hz IF bandwidth	≤ -108 dBm	
1 kHz IF bandwidth	≤ -88 dBm	
Receiver noise floor^a		
300 kHz to 25 MHz ^c		
10 Hz IF bandwidth	≤ -130 dBm	
1 kHz IF bandwidth	≤ -110 dBm	
25 MHz to 3 GHz ^c		
10 Hz IF bandwidth	≤ -133 dBm	
1 kHz IF bandwidth	≤ -113 dBm	
3 GHz to 9 GHz		
10 Hz IF bandwidth	≤ -123 dBm	
1 kHz IF bandwidth	≤ -103 dBm	
Crosstalk		
300 kHz to 1 MHz	< -120 dB	Between test ports 1 and 2 with shorts on both ports.
1 MHz to 25 MHz	< -125 dB	
25 MHz to 3 GHz	< -128 dB	
3 GHz to 6 GHz	< -118 dB	
6 GHz to 9 GHz	< -113 dB	
Trace noise magnitude^d		
1 kHz IF bandwidth	<0.002 dB rms	
10 kHz IF bandwidth	<0.005 dB rms	
Trace noise phase^d		
1 kHz IF bandwidth	<0.010° rms	
10 kHz IF bandwidth	<0.035° rms	

a. rms value of a linear magnitude trace expressed in dBm.

b. May be limited to -90 dBm at particular frequencies below 750 MHz due to spurious receiver residuals.

c. May be limited to -105 dBm at particular frequencies below 750 MHz due to spurious receiver residuals.

d. Trace noise is defined as a ratio measurement of a through or a full reflection, with the source set to +0 dBm.

Test port input (continued)

Description	Specification	Supplemental information
Reference level magnitude		
Range	±200 dB	
Resolution	0.001 dB	
Reference level phase		
Range	±500°	
Resolution	0.01°	
Stability magnitude^a		
300 kHz to 3 GHz		0.02 dB/°C, typical
3 GHz to 6 GHz		0.04 dB/°C, typical
6 GHz to 9 GHz		0.06 dB/°C, typical
Stability phase^a		
300 kHz to 3 GHz		0.2°/°C, typical
3 GHz to 6 GHz		0.3°/°C, typical
6 GHz to 9 GHz		0.6°/°C, typical
Maximum test port input level (Test port 1,2)		
300 kHz to 25 MHz	+10 dBm	<0.6 dB compression
25 MHz to 3 GHz	+10 dBm	<0.4 dB compression
3 GHz to 6 GHz	+10 dBm	<0.7 dB compression
6 GHz to 9 GHz	+5 dBm	<0.7 dB compression
Maximum receiver input level (A, B, R1, R2)		
300 kHz to 6 GHz		-6 dBm, typical
6 GHz to 9 GHz		-11 dBm, typical
Maximum coupler input level (option 015)		
300 kHz to 9 GHz		+33 dBm, typical
Reference input level (R1, R2)^b		
300 kHz to 9 GHz		-10 to -35 dBm, typical
Damage input level		
Test port 1, 2		+30 dBm or ± 30 VDC, typical
R1, R2 IN		+15 dBm or ± 15 VDC, typical
A, B IN (standard)		+15 dBm or ± 15 VDC, typical
A, B IN (option 015)		+15 dBm or 0 VDC, typical
Coupler IN (option 015)		+36 dBm or ± 25 VDC, typical

a. Stability is defined as a ratio measurement measured at the test port.

b. Input level to maintain phase-lock.

Test port input (continued)

Dynamic accuracy

Accuracy of the test port input power reading is relative to the reference input power level. Applies to input test ports 1 and 2 with 10 Hz IF bandwidth.

Specification

300 kHz to 3 GHz

Magnitude

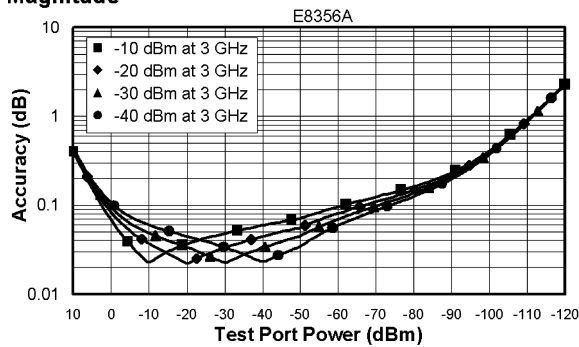

Characteristic

300 kHz to 3 GHz

Phase

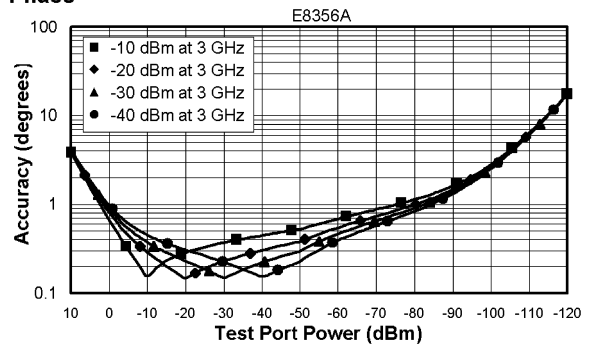

300 kHz to 6 GHz

Magnitude

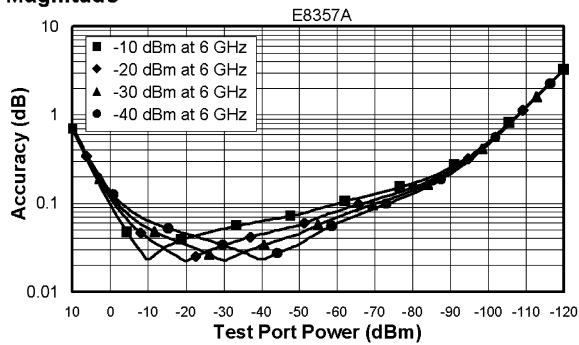

300 kHz to 6 GHz

Phase

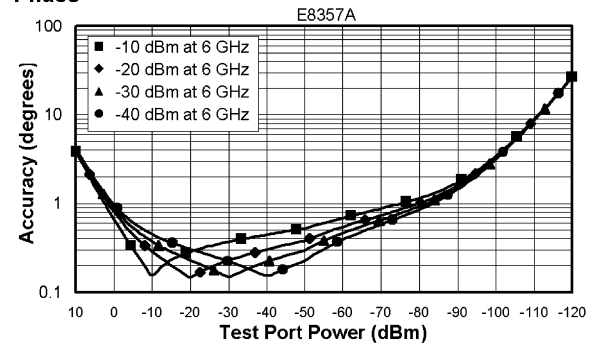

300 kHz to 9 GHz

Magnitude

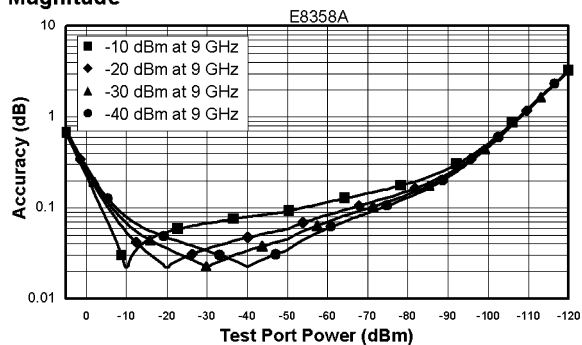

300 kHz to 9 GHz

Phase

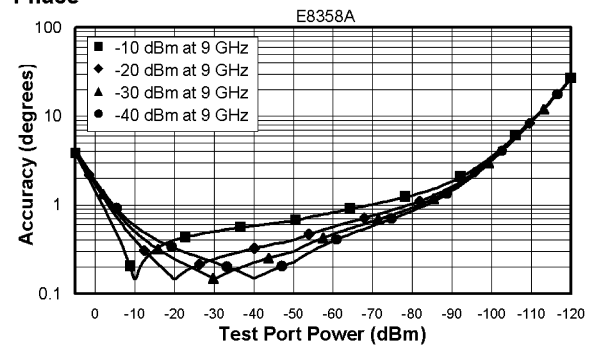

Test port input (continued)

Group delay^a

Description	Specification	Supplemental information
Aperture (selectable)	(frequency span)/(number of points – 1)	
Maximum aperture	20% of frequency span	
Range	0.5 x (1/minimum aperture)	
Maximum delay		Limited to measuring no more than 180° of phase change within the minimum aperture.

The following graph shows characteristic group delay accuracy with type-N full 2-port calibration and a 10 Hz IF bandwidth. Insertion loss is assumed to be < 2 dB and electrical length to be ten meters.

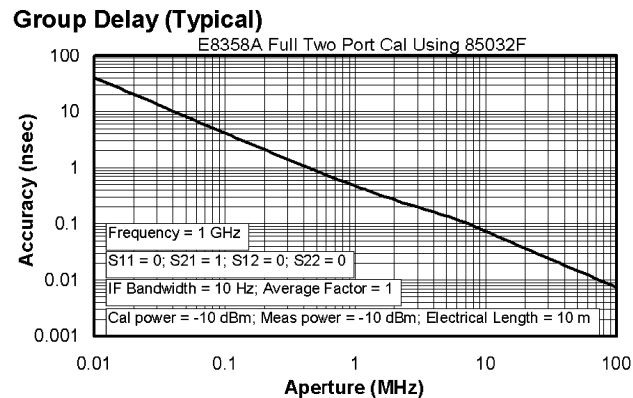

In general, the following formula can be used to determine the accuracy, in seconds, of a specific group delay measurement:

$$\pm \text{Phase accuracy (deg)} / [360 \times \text{Aperture (Hz)}]$$

Depending on the aperture and device length, the phase accuracy used is either incremental phase accuracy or worse case phase accuracy.

a. Group delay is computed by measuring the phase change within a specified frequency step (determined by the frequency span and the number of points per sweep).

General information

Description	Supplemental Information
System IF bandwidth range	1 Hz to 40 kHz in a 1, 2, 3, 5, 7, 10 sequence up to 30 kHz, 35 kHz, 40 kHz, nominal
RF connectors Connector center pin protrusion	Type-N, female; 50 Ω, nominal 0.204 to 0.207 in, characteristic
Probe power Positive supply Negative supply	3-pin connector, male +15 VDC ±2%, 400 mA max, characteristic –12.6 VDC ±5%, 300 mA max, characteristic

General information (continued)

Description	Supplemental information
Display	21.3 cm (8.4 in) diagonal color active matrix LCD; 640 (horizontal) x 480 (vertical) resolution; 59.83 Hz vertical refresh rate; 31.41 Hz horizontal refresh rate
Display range	
Magnitude	±200 dB (at 20 dB/div), max
Phase	±180°, max
Polar	10 pUnits, min; 1000 Units, max
Display resolution	
Magnitude	0.001 dB/div, min
Phase	0.01°/div, min
Marker resolution	
Magnitude	0.001 dB, min
Phase	0.01°, min
Polar	0.01 mUnit, min; 0.01°, min
Rear panel	
Test port bias input	BNC, female
Maximum voltage	±30 VDC, typical
Maximum current (no degradation in RF specifications)	±200 mA, typical
Maximum current	±1 A, typical
10 MHz reference in	BNC, female
Input frequency	10 MHz ±1 ppm, typical
Input level	-15 dBm to +20 dBm, typical
Input impedance	200 Ω, nominal
10 MHz reference out	BNC, female
Output frequency	10 MHz ±1 ppm, typical
Signal type	Sine wave, typical
Output level	10 dBm ±4 dB into 50 Ω, typical
Output impedance	50 Ω, nominal
Harmonics	< -40 dBc, typical
VGA video output	15-pin mini D-Sub, female; drives VGA-compatible monitors
GPIB	24-pin D-24, female; compatible with IEEE-488
Parallel port (LPT1)	36-pin, mini-D, 1284-C connector; provides connection to printers or any other parallel port peripheral
Serial port (COM1)	9-pin D-Sub, male; compatible with RS-232
USB Port	Type-A configuration (4 contacts inline, contact 1 on left), female
Contact 1	Vcc: 4.75 to 5.25 VDC, 500 mA max
Contact 2	-Data
Contact 3	+Data
Contact 4	Ground
LAN	10/100BaseT Ethernet; 8-pin configuration; auto selects between the two data rates
External detector input	BNC, female; input from an external, negative polarity diode detector provides ALC for a test port remote from instrument's front panel
Input sensitivity	-500 mV yields approximately -3 dBm at detector's input, typical
Bandwidth	50 kHz, typical
Input impedance	1 kΩ, nominal

General information (continued)

Description	Supplemental Information
External AM input	BNC, female; voltage input provides low frequency AM modulation to test port output signal, or shifts the test port output power to level other than that set by instrument
Input sensitivity	8 dB/volt, typical
Bandwidth	1 kHz, typical
Input impedance	1 k Ω , nominal
Line Power^a	
Frequency	48 Hz to 66 Hz
Voltage at 115 V setting	90 to 132 VAC; 120 VAC, nominal
Voltage at 220 V setting	198 to 264 VAC; 240 VAC, nominal
VA max	600 VA max
General environmental	
RFI/EMI susceptibility	Defined by CISPR Pub. 11, Group 1, Class A, and IEC 50082-1
ESD	Minimize using static-safe work procedures and an antistatic bench mat
Dust	Minimize for optimum reliability
Operating environment	
Temperature	0 °C to +40 °C; instrument powers up, phase locks, and displays no error messages within this temperature range.
Error-corrected temperature range	System specifications valid from 25 °C \pm 5 °C, with less than 1 °C deviation from the calibration temperature, unless otherwise noted
Humidity	5% to 95% at +40 °C
Altitude	0 to 4500 m (14,760 ft.)
Non-operating storage environment	
Temperature	-40 °C to +70 °C
Humidity	0 to 90% at +65 °C (non-condensing)
Altitude	0 to 15,240 m (50,000 ft.)
Cabinet dimensions	Excludes front and rear protrusions.
Height x Width x Depth	222 x 425 x 426 mm, nominal (8.75 x 16.75 x 16.8 in, nominal)
Weight	
Net	24 kg (54 lb), nominal
Shipping	32 kg (70 lb), nominal

a. A third-wire ground is required.

Measurement throughput summary

Cycle time vs. IF bandwidth^a

Instrument state: preset condition, 201 points, CF = 1 GHz, Span = 100 MHz, correction off, display off. Add 21 ms for display on. Cycle time includes sweep and re-trace time.

IF bandwidth (Hz)	Cycle time (ms)
40,000	8
35,000	9
30,000	11
20,000	13
10,000	28
7,000	36
5,000	48
3,000	72
1,000	196
300	620
100	1875
30	8062
10	17877

Cycle time vs. number of points^a

Instrument state: preset condition, 35 kHz IF bandwidth, CF = 1 GHz, Span = 100 MHz, correction off, display off. Add 21 ms for display on. Cycle time includes sweep and re-trace time.

Number of points	Cycle time (ms)
3	4
11	4
51	5
101	6
201	9
401	16
801	29
1601	52

Cycle time ^{a,b} (ms)

	Number of points			
	51	201	401	1601
Start 800 MHz, Stop 1000 MHz, 35 kHz IF bandwidth				
Uncorrected, 1-port cal	6	10	17	53
2-port cal	18	27	39	113
Start 300 kHz, Stop 3 GHz, 35 kHz IF bandwidth				
Uncorrected, 1-port cal	32	43	52	93
2-port cal	73	97	117	201
Start 300 kHz, Stop 6 GHz, 35 kHz IF bandwidth				
Uncorrected, 1-port cal	40	50	57	98
2-port cal	88	109	125	210
Start 300 kHz, Stop 9 GHz, 35 kHz IF bandwidth				
Uncorrected, 1-port cal	45	55	61	99
2-port cal	99	119	133	212
Time Domain^c (increase over uncorrected sweep time)				
Conversions	<1	<1	4	13
Gating	<1	<1	4	17

a. Typical performance.

b. Includes sweep time, retrace time and band-crossing time. Analyzer display turned off with DISPLAY:ENABLE OFF. Add 21 ms for display on. Data for one trace (S11) measurement.

c. Option 010 only. Analyzer display turned off with DISPLAY:ENABLE OFF. Add 21 ms for display on.

Data transfer time (ms)^a

	Number of points			
	51	201	401	1601
SCPI over GPIB				
(program executed on external PC)^b				
32-bit floating point	4	7	13	41
64-bit floating point	7	14	24	81
ASCII	25	98	189	804
SCPI over 10 Mbit/s LAN				
(program executed on external PC)^c				
32-bit floating point	5	6	8	21
64-bit floating point	5	9	22	38
ASCII	18	53	98	362
SCPI over 100 Mbit/s LAN				
(program executed on external PC)^c				
32-bit floating point	3	5	6	12
64-bit floating point	4	6	9	20
ASCII	17	51	92	339
SCPI (program executed in the analyzer)^d				
32-bit floating point	2	3	4	7
64-bit floating point	4	5	6	15
ASCII	26	99	198	781
COM (program executed in the analyzer)^e				
32-bit floating point ^g	1	1	1	2
Variant type ^h	1	3	4	19
DCOM over 10 Mbits/s LAN				
(program executed on external PC)^f				
32-bit floating point ^g	2	3	5	14
Variant type ^h	5	14	26	100
DCOM over 100 Mbits/s LAN				
(program executed on external PC)^f				
32-bit floating point ^g	2	2	2	4
Variant type ^h	3	5	9	35

a. Typical performance.

b. Measured using a VEE 5.0 program running on a 600 MHz HP Kayak, National Instruments™ GPIB card. Transferred complex S₁₁ data, using "CALC:DATA? SDATA".

c. Measured using a VEE 5.0 program running on a 600 MHz HP Kayak. Transferred complex S₁₁ data, using "CALC:DATA? SDATA". Speed dependent on LAN traffic, if connected to network.

d. Measured using a VEE 5.0 program running inside PNA Series analyzer. Transferred complex S₁₁ data, using "CALC:DATA? SDATA".

e. Measured using a Visual Basic 6.0 program running inside PNA Series analyzer. Transferred complex S₁₁ data.

f. Measured using a Visual Basic 6.0 program running on a 600 MHz HP Kayak. Transferred complex S₁₁ data. Speed dependent on LAN traffic, if connected to network.

g. Used larray transfer (getComplex) for 32-bit floating point.

h. Used meas.GetData for Variant type.

PNA Series simplified test set block diagram

Standard

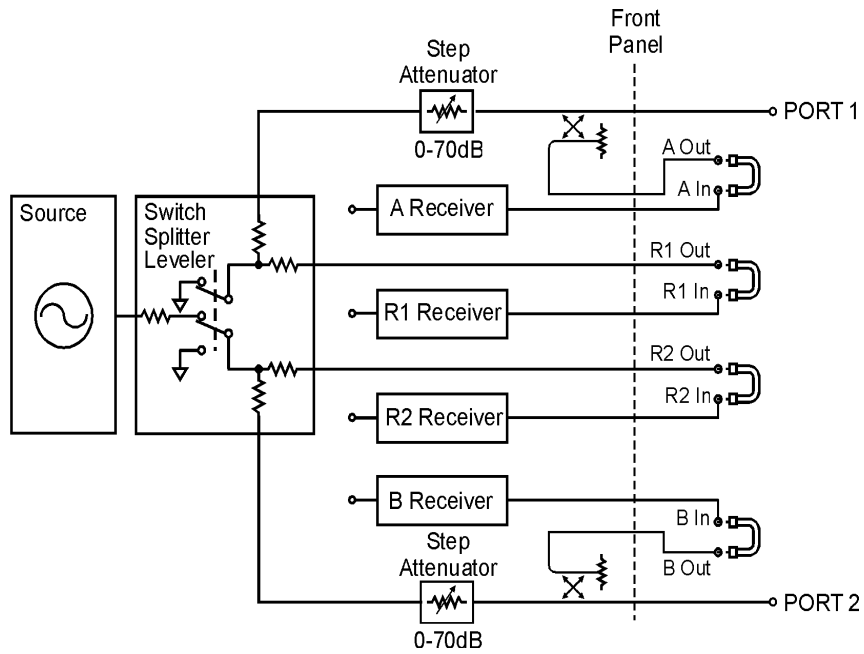

Option 015

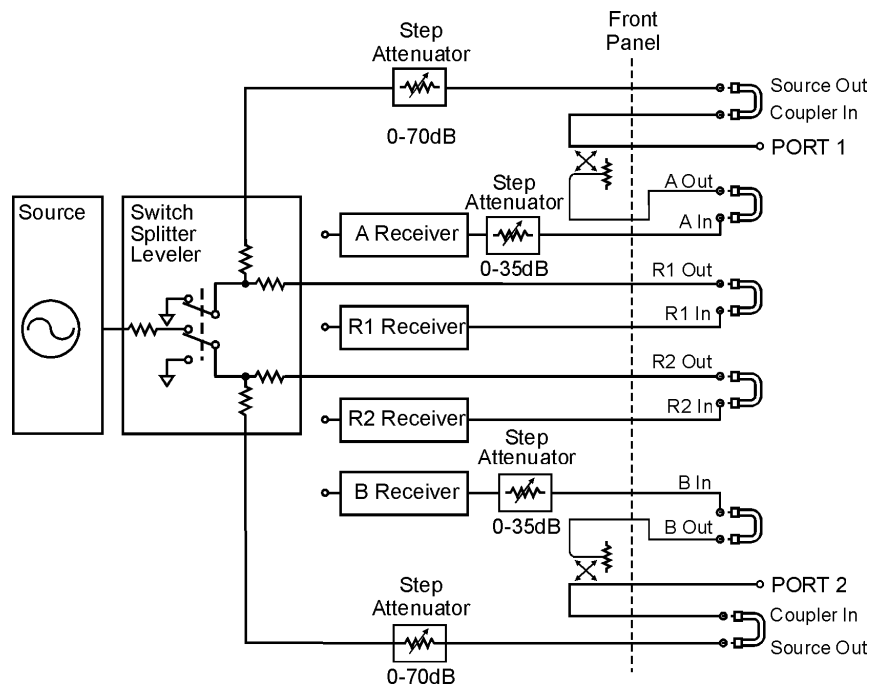

Measurement capabilities

Number of measurement channels

Up to four independent measurement channels. A measurement channel is coupled to stimulus response settings including frequency, IF bandwidth, power level, and number of points.

Number of display windows

Up to 4 display windows. Each window can be sized and re-arranged. Up to 4 measurement channels can be displayed per window.

Number of traces

Up to 4 active traces and 4 memory traces per window. 16 total active traces and 16 memory traces can be displayed using four windows. Measurement traces include S-parameters, as well as relative and absolute power measurements.

Measurement choices

S11, S21, S12, S22, A/R1, A/R2, A/B, B/R1, B/R2, B/A, R1/A, R1/B, R1/R2, R2/A, R2/B, R2/R1, A, B, R1, R2

Formats

Log or linear magnitude, SWR, phase, group delay, real and imaginary, Smith chart, polar.

Data markers

10 independent markers per trace. Reference marker available for delta marker operation. Marker formats include log or linear magnitude, phase, real, imaginary, SWR, delay, $R + jX$, and $G + jB$.

Marker functions

Marker search

Max value, Min value, Target, Next Peak, Peak right, Peak left, Target, Bandwidth with user-defined target values

Marker-to functions

Set start, stop, center to active marker stimulus value; set reference to active marker response value; set electrical delay to value of slope of phase response at active marker.

Tracking

Performs marker search continuously or on demand.

Source control

Measured number of points per sweep

User definable from 2 to 1601.

Sweep type

Linear, CW (single frequency), power or segment sweep

Segment sweep

Define independent sweep segments. Set number of points, test port power levels, IF bandwidth, and sweep time independently for each segment.

Sweep trigger

Set to continuous, hold, single, or group sweep with internal or external trigger.

Power

Set source power from -85 to +10 dBm. Power slope can also be set in dBm/GHz.

Trace functions

Display data

Display current measurement data, memory data, or current measurement and memory data simultaneously.

Trace math

Vector addition, subtraction, multiplication or division of measured complex values and memory data.

Title

Add custom titles (50 characters maximum) to the display. Titles will be printed when making hardcopies of displayed measurements.

Autoscale

Automatically selects scale resolution and reference value to vertically center the trace.

Electrical delay

Offset measured phase or group delay by a defined amount of electrical delay, in seconds.

Phase Offset

Offset measured phase or group delay by a defined amount in degrees.

Statistics

Calculates and displays mean, standard deviation and peak-to-peak deviation of the active data trace.

Data accuracy enhancement

Measurement calibration

Measurement calibration significantly reduces measurement uncertainty due to errors caused by system directivity, source and load match, tracking and crosstalk. Full two-port calibration removes all the systematic errors to obtain the most accurate measurements.

Calibration types available

Response

Simultaneous magnitude and phase correction of frequency response errors for either reflection or transmission measurements

Response and isolation

Compensates for frequency response and crosstalk errors of transmission measurements.

One-port calibration

Available on test set port 1 or port 2 to correct for directivity, frequency response and source match errors.

Two-port calibration

Compensates for directivity, source match, reflection tracking, load match, transmission tracking and crosstalk. Crosstalk calibration can be omitted.

TRL/TRM calibration

Compensates for directivity, reflection and transmission tracking, source match, load match and crosstalk in both forward and reverse directions. Provides the highest accuracy for both coaxial and non-coaxial environments, such as on-wafer probing, in-fixture or waveguide measurements.

Interpolated error correction

With any type of accuracy enhancement applied, interpolated mode recalculates the error coefficients when the test frequencies are changed. The number of points can be increased or decreased and the start/stop frequencies can be changed, but the resulting frequency range must be within the original calibration frequency range. System performance is not specified for measurements with interpolated error correction applied.

Velocity factor

Enter the velocity factor to calculate the equivalent physical length.

Reference port extension

Redefine the measurement plane from the plane where the calibration was done.

Storage

Internal hard disk drive

Store and recall instrument states and calibration data on 6 GB, minimum, internal hard drive. Instrument data can also be saved in binary or ASCII (including S2P) format. All files are MS-DOS®-compatible. Instrument states include all control settings, active limit lines, active segment sweep tables, and memory trace data.

Disk drive

Instrument data, instrument states, and calibration data can be stored on an internal 3.5 inch 1.4MB floppy disk in MS-DOS®-compatible format.

External storage options

Instrument data, instrument states and calibration data can also be stored on external CD-RW drive or servers using Windows® 2000 drive mapping.

Data hardcopy

Printouts of instrument data are directly produced on any printer with the appropriate Windows® 2000 printer driver. The analyzer provides USB, parallel, serial and LAN interfaces.

System capabilities

Familiar graphical user interface

The PNA Series analyzer employs a graphical user interface based on Windows® 2000. There are two fundamental ways to operate the instrument manually: you can use a hardkey interface, or use drop-down-menus driven from a mouse (or another standard USB pointing device). Hardkey navigation brings up active toolbars that perform most of the operations required to configure and view measurements. Front-panel navigation keys allow control of dialog boxes for advanced features. In addition, mouse-driven pull-down menus and dialog boxes provide easy access to features.

Built-in help system

Embedded documentation provides measurement assistance in five different languages (English, French*, German*, Japanese*, and Spanish*). A thorough index of help topics and context-sensitive help available from dialog boxes. (* available early 2001)

Limit lines

Define test limit lines that appear on the display for pass/fail testing. Lines may be any combination of horizontal, sloping lines, or discrete data points.

Time-domain (Option 010)

With the time-domain option, data from transmission or reflection measurements in the frequency domain are converted to the time domain using a Fourier transformation technique and presented on the display. The time-domain response shows the measured parameter value versus time. Markers may also be displayed in electrical length (or physical length if the relative propagation velocity is entered).

Time stimulus modes

Two types of time excitation stimulus waveforms can be simulated during the transformations, a step and an impulse.

Low-pass step

This stimulus, similar to a traditional time-domain reflectometer (TDR) waveform, is used to measure low-pass devices. The frequency-domain data is extended from DC (extrapolated value) to a higher value. The step response is typically used for reflection measurements only.

Low-pass impulse

This stimulus is also used to measure low-pass devices. The impulse response can be calibrated for reflection or transmission measurements.

Bandpass impulse

The bandpass impulse simulates a pulsed RF signal (with an impulse envelope) and is used to measure the time-domain response of band-limited devices. The start and stop frequencies are selectable by the user to any values within the limits of the instrument. Bandpass time-domain responses are useful for both reflection and transmission measurements.

Time-domain range

The "alias-free" range over which the display is free of response repetition depends on the frequency span and the number of points. Range, in nanoseconds, is determined by:

$$\text{Time-domain-range} = (\text{number-of-points} - 1) / \text{frequency-span [in GHz]}$$

Range resolution

The time resolution of a time-domain response is related to range as follows:

$$\text{Range-resolution} = \text{time-span} / (\text{number-of-points} - 1)$$

Windows

The windowing function can be used to modify (filter) the frequency-domain data and thereby reduce overshoot and ringing in the time-domain response. Kaiser Beta windows are available.

Gating

The gating function can be used to selectively remove reflection or transmission time-domain responses. In converting back to the frequency-domain the effects of the responses outside the gate are removed.

Configurable test set (Option 015)

With the configurable test set option, front panel access loops are provided to the signal path between the source output and coupler input. 35 dB step attenuators (5 dB steps) are also added in the receiver paths of both ports. This capability provides the ability to add components or other peripheral instruments for a variety of measurement applications or to make high dynamic range measurements with two-port calibration.

High power measurement configuration

Add external power amplifier(s) between the source output and coupler input to provide up to +30 dBm of power at the test port(s). Full two-port error correction measurements possible. When the DUT output is expected to be less than +30 dBm, measure directly at the B input and use the internal step attenuators to prevent damage to the receiver. For measurements greater than +30 dBm, add external components such as couplers, attenuators, and isolators.

Extended dynamic range configuration

Reverse the signal path in the coupler and bypass the loss typically associated with the coupled arm. Change the port 2 switch and coupler jumper configurations to increase the forward measurement dynamic range up to 143 dB. When making full two-port error corrected measurements, the reverse measurement is degraded by 15 dB, with up to 113 dB of dynamic range available.

Automation

	GPIB	LAN	Internal
SCPI	X	X	X
COM/DCOM		X	X

Methods

Internal analyzer execution

Write applications that can be executed from within the analyzer via COM (component object model) or using SCPI . These applications can be developed in a variety of languages, including Visual Basic, Visual C++, Agilent-VEE, or LabView™ programming languages.

Controlling via GPIB

The GPIB interface operates to IEEE 488.2 and SCPI protocols. The analyzer can either be the system controller, or talker/listener.

Controlling via LAN

The built-in LAN interface and firmware support data transfer and control via direct connection to a 10 or 100 Base-T network.

SICL/LAN interface

The analyzer's support for SICL (standard instrument control library) over the LAN provides control of the network analyzer using a variety of computing platforms, and operating systems. With SICL/LAN, the analyzer is controlled remotely over the LAN with the same methods used for a local analyzer connected directly to the computer via a GPIB interface.

DCOM interface

The analyzer's support for DCOM (Distributed Component Object Model) over the LAN provides control of the network analyzer using a variety of platforms. DCOM acts as an interface to the analyzer for external applications. With DCOM, applications can be developed or executed from an external computer. During development, the application can interface to the analyzer over the LAN through the DCOM interface. Once development is completed, the application can be executed on the analyzer using the COM interface.

Key literature and web references:

Agilent PNA Series Brochure: 5968-8472E
Agilent PNA Series Configuration Guide: 5980-1235E

Find us on the web at:

<http://www.agilent.com/find/pna>
http://www.agilent.com/find/component_test

Agilent Technologies' Test and Measurement Support, Services, and Assistance

Agilent Technologies aims to maximize the value you receive, while minimizing your risk and problems. We strive to ensure that you get the test and measurement capabilities you paid for and obtain the support you need. Our extensive support resources and services can help you choose the right Agilent products for your applications and apply them successfully. Every instrument and system we sell has a global warranty. Support is available for at least five years beyond the production life of the product. Two concepts underlie Agilent's overall support policy: "Our Promise" and "Your Advantage."

Our Promise

Our Promise means your Agilent test and measurement equipment will meet its advertised performance and functionality. When you are choosing new equipment, we will help you with product information, including realistic performance specifications and practical recommendations from experienced test engineers. When you use Agilent equipment, we can verify that it works properly, help with product operation, and provide basic measurement assistance for the use of specified capabilities, at no extra cost upon request. Many self-help tools are available.

Your Advantage

Your Advantage means that Agilent offers a wide range of additional expert test and measurement services, which you can purchase according to your unique technical and business needs. Solve problems efficiently and gain a competitive edge by contacting us for calibration, extra-cost upgrades, out-of-warranty repairs, and on-site education and training, as well as design, system integration, project management, and other professional services. Experienced Agilent engineers and technicians worldwide can help you maximize your productivity, optimize the return on investment of your Agilent instruments and systems, and obtain dependable measurement accuracy for the life of those products.

Microsoft® and Windows® and MS-DOS® are U.S. registered trademarks of Microsoft Corporation

National Instrument™ and Labview™ are trademarks of National Instruments Corporation

For more assistance with your test and measurement needs go to

www.agilent.com/find/assist

Or contact the test and measurement experts at Agilent Technologies
(During normal business hours)

United States:

(tel) 1 800 452 4844

Canada:

(tel) 1 877 894 4414
(fax) (905) 206 4120

Europe:

(tel) (31 20) 547 2000

Japan:

(tel) (81) 426 56 7832
(fax) (81) 426 56 7840

Latin America:

(tel) (305) 267 4245
(fax) (305) 267 4286

Australia:

(tel) 1 800 629 485
(fax) (61 3) 9272 0749

New Zealand:

(tel) 0 800 738 378
(fax) 64 4 495 8950

Asia Pacific:

(tel) (852) 3197 7777
(fax) (852) 2506 9284

Product specifications and descriptions in this document subject to change without notice.

Copyright © 2000 Agilent Technologies
Printed in USA 09/2000
5980-1236E



Agilent Technologies

Innovating the HP Way