



# Advanced Test Equipment Rentals

www.atecorp.com 800-404-ATEC (2832)

OmniSource™ Sound Source — Type 4295  
Tapping Machine — Type 3207  
Including Power Amplifier — Type 2716



### *Sound Sources for Building Acoustics*

For the proper measurement of building acoustics a range of sound sources is required, which should fulfil the relevant standards, e.g. ISO 140.

Brüel & Kjær offers a complete range of sound sources for building acoustics measurements including Tapping Machine Type 3207, OmniSource™ Type 4295 single speaker omnidirectional sound source and OmniPower™ Type 4296 high power omnidirectional sound source.

There is also a range of accessories available including Power Amplifier Type 2716 for driving both OmniPower and OmniSource, Flight Case KE 0358 for transporting the Type 2716, cables, Wireless Transmission Kit UA 1426 and the 2260 Investigator™ sound level analyzer.

**4296, 4295, 3207**

- USES**
- Architectural and building acoustics
  - Measurement of:
    - Airborne sound insulation
    - Reverberation time
    - Impact sound level

- FEATURES**
- Part of a complete building acoustics system featuring Brüel & Kjær's Investigator Type 2260D
  - Two omni-directional noise sources
  - Tapping machine for impact sound level measurements
  - Remote operation via cable or wireless remote control
  - Satisfies national and international standards
  - Robust
  - Easily portable

---

## Introduction

---

Architectural and building acoustic measurements require a range of noise sources for airborne noise and impact noise transmission measurements. For airborne noise transmission measurements, an omnidirectional sound source is needed. Brüel & Kjær offers two solutions: OmniPower Sound Source Type 4296 and OmniSource Sound Source Type 4295.

For impact sound measurements Brüel & Kjær offers Tapping Machine Type 3207. This is a robust and portable device that fulfils national and international standards.

The sound sources form part of a measurement system starting with the sound sources and where necessary the driving amplifier (e.g., Type 2176), followed by a sound level analyzer (e.g., 2260 Investigator), a PC and software, and the connecting cables or wireless transmission kits (UA 1426 or UA 1476 for the tapping machine). Brüel & Kjær supplies all of these items except the PC, and a range of carrying cases for storage and transportation.

Summary:

- OmniPower Type 4296, 12-speaker high power omnidirectional sound source
- OmniSource Type 4295, lightweight single speaker omnidirectional sound source
- Tapping Machine Type 3207
- Power Amplifier Type 2716, portable amplifier for driving sound sources
- Flight Cases KE 0348, KE 0365 and Carrying Case KE 0364 for packing and transporting equipment
- Cables and Wireless Remote Control Kits UA 1426 and UA 1476
- Battery Kit UA 1477

# Omni-directional Sound Sources

For most building acoustics measurements, the sound source must radiate sound evenly in all directions to give reproducible and reliable results. Hence the relevant standards for the measurement of building acoustics (ISO 140 and ISO 3382) require that an omnidirectional sound source be used.

## OmniPower Sound Source Type 4296

Fig. 1 OmniPower Sound Source Type 4296



OmniPower Sound Source Type 4296 (see Fig. 1) uses a cluster of 12 loudspeakers in a dodecahedral configuration that radiates sound evenly with a spherical distribution. All twelve speakers are connected in a series-parallel network to ensure both in-phase operation and an impedance that matches the power amplifier. The whole assembly weighs 14 kg and is fitted with a convenient lifting handle which does not measurably interfere with the sound field.

When connected via the Bridging Cable AQ 0621, OmniPower can utilise the combined output power of both channels of the Power Amplifier Type 2716, and deliver a sound power of 122 dB re 1 pW (see Fig. 2 and Fig. 3). OmniPower's high power output makes it ideal for sound insulation measurements.

Fig. 2 Maximum 1/3-octave sound power levels for OmniPower using 2260 Investigator pink noise generator and Power Amplifier Type 2716

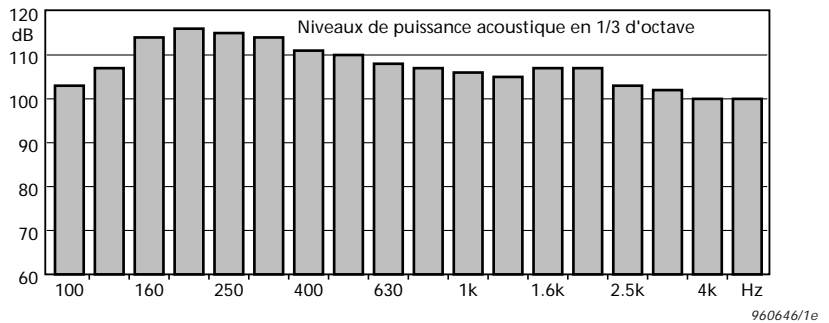
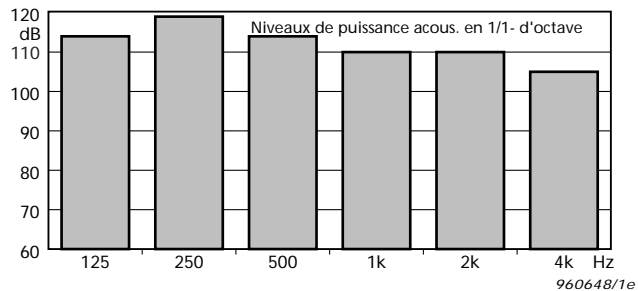
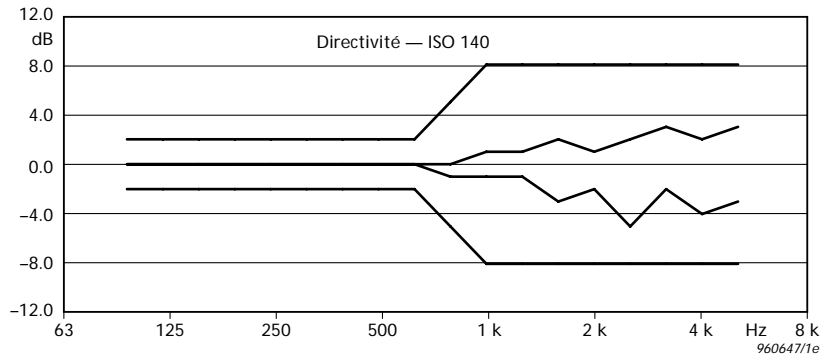

Fig. 3 Maximum 1/1-octave sound power levels for OmniPower using 2260 Investigator pink noise generator and Power Amplifier Type 2716



OmniPower satisfies the requirements of DIN 52210, ISO 140 and ISO 3382 standards (see Fig. 2 and Fig. 3).

*Fig. 4 Directivity for OmniPower according to ISO 140: maximum deviation from mean for 'gliding' 30° arc. Upper and lower curves are the ISO 140 tolerances*



*Fig. 5 Directivity for OmniPower according to ISO 3382: maximum deviation from mean for 'gliding' 30° arc. Upper and lower curves are the ISO 3382 tolerances*

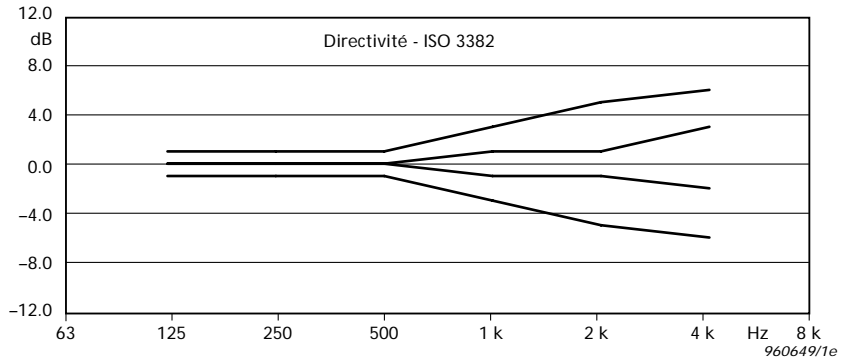

*Fig. 6 OmniSource Sound Source Type 4295*



### OmniSource Sound Source Type 4295

OmniSource Sound Source Type 4295 (see Fig. 6) presents a new solution to omnidirectional sound source design. OmniSource is optimised for the measurement of room acoustic quantities, such as reverberation time, sound distribution and spatial decay. The patented principle of the OmniSource uses a single high-power loudspeaker, radiating through a conical coupler to a circular orifice. The size of the orifice and the shape of the OmniSource have been carefully engineered to radiate sound evenly in all directions. Thus, the OmniSource fulfils the national and international standards for omnidirectional sound sources (see Fig. 9 and Fig. 10).

Despite its compact dimensions and low weight, the OmniSource is still capable of emitting a sound power of 105 dB re 1 pW (see Fig. 7 and Fig. 8).

Fig. 7 Maximum  $1/3$ -octave sound power levels for OmniSource using 2260 Investigator pink noise generator and Type 2716 Power Amplifier

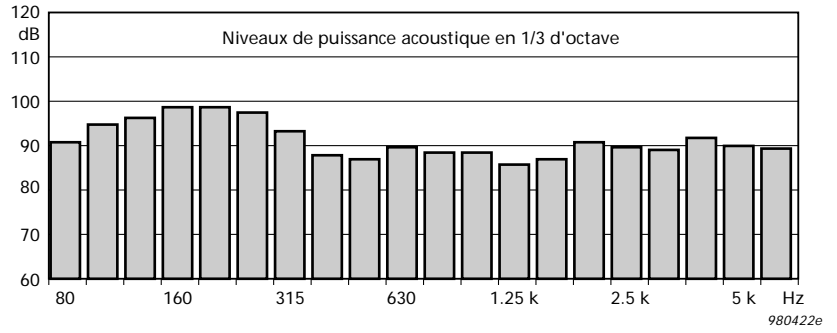

Fig. 8 Maximum  $1/1$ -octave sound power levels for OmniSource using 2260 Investigator pink noise generator and Type 2716 Power Amplifier

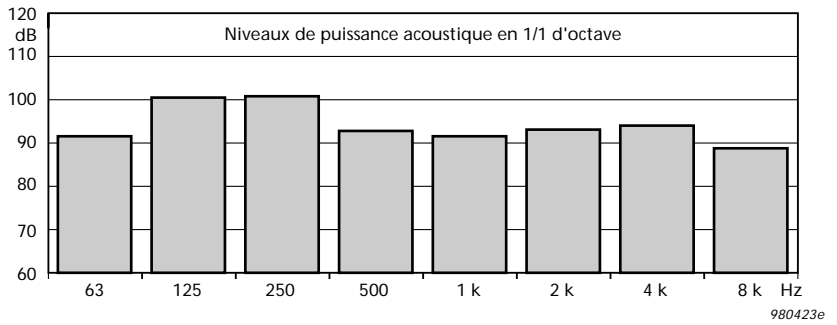

Fig. 9 Directivity for OmniSource according to ISO 140 maximum deviation from mean for 'gliding' 30° arc. Upper and lower curves are the ISO tolerances

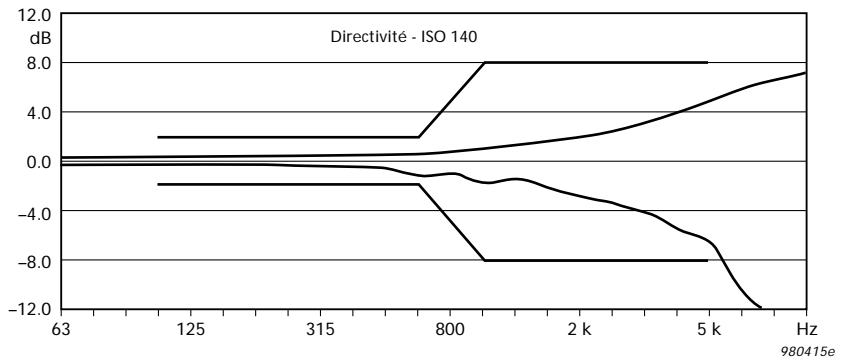
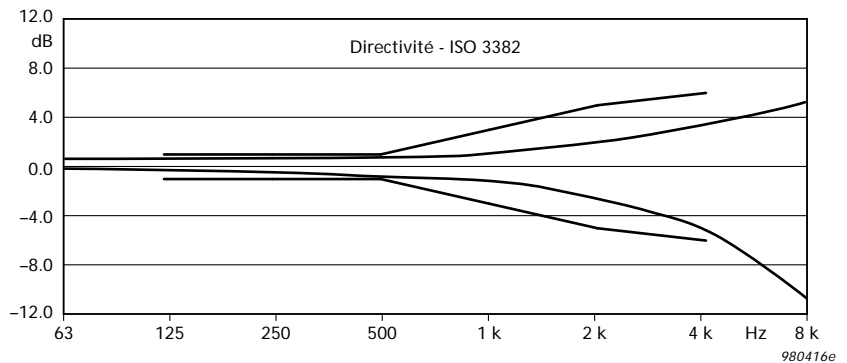

Fig. 10 Directivity for OmniSource according to ISO 3382: maximum deviation from mean for 'gliding' 30° arc. Upper and lower curves are the ISO tolerances



### Tapping Machine Type 3207

Tapping Machine Type 3207 is an impact sound generator (see Fig. 11). It can be used for impact sound measurements to national and international standards. The unit is available with an optional battery kit and a remote control.

Type 3207 uses five hammers each weighing 500 g and operating at 2 Hz dropping from a height of 40 mm, giving an operating frequency of 10 Hz. This fulfils national and international standards. The hammers are operated via tappets on a single shaft. The shaft is driven by a DC motor via a toothed belt and gearbox.

Fig. 11 Tapping Machine Type 3207



The unit is based around a welded aluminium chassis. Both size and weight have been minimised for easy transportation. Three extendable legs with rubber feet support the unit during operation. The rubber feet are height adjustable with supplied gauges. This gives stable and level mounting during

operation in accordance with the relevant standards.

The unit is powered via the supplied mains adaptor, or the optional battery kit (see Fig. 12). The unit can be remotely switched on and off with cable AQ 0633 or Wireless Remote Control Option UA 1476 (see Fig. 12).

Fig. 12 Accessories for Tapping Machine. Wireless Remote Control UA 1476 (left) and Battery Kit UA 1477 (right)

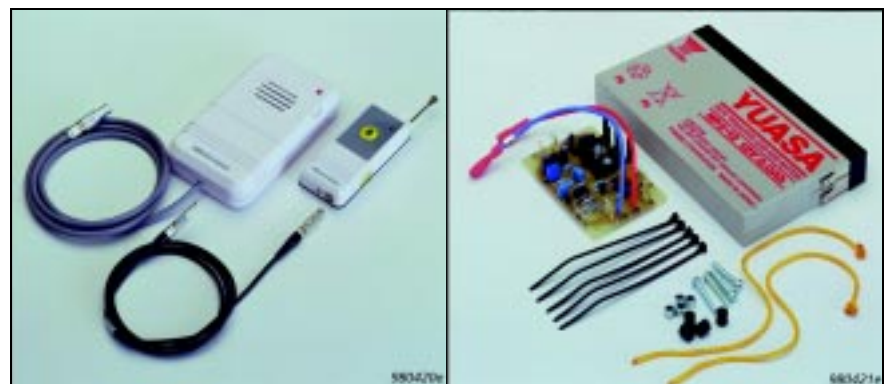



*Fig. 13 Power Amplifier Type 2716 fitted in Flight Case KA 0358 from where it can be operated*



*Power Amplifier Type 2716 is of compact size and low weight for its output power. It has the same features and protection circuits normally found only in higher powered amplifiers. This makes it one of the few really professional power amplifiers in its class.*

### Power Amplifier Type 2716

Power Amplifier Type 2716 (see Fig. 13) fits in a 19" rack or in Flight Case KE 0358. It has two channels which may be used independently or jointly (using the **Link A+B** and **Phase Reverse B** switches, and Bridging Cable AQ 0621). Signals enter electronically balanced inputs via XLR and jack connectors. Input level requirements are matched by the signals generated by the 2260 Investigator. Total output power is around 300 W and is relatively independent of load. This matches the requirements for driving the OmniPower with a wide margin of safety against damaging the speaker units. A single channel can be used to drive the OmniSource. The Type 2716 will deliver full output power for a duty cycle of  $\frac{1}{3}$ , matching typical operating modes in building acoustic measurements.

#### *Quiet Operation*

Type 2716 uses passive cooling during operation which removes the need for a cooling fan. The lack of cooling fan in turn makes the Type 2716 very quiet during operation, an essential feature for building acoustics measurements.

#### *Extensive Protection*

Power Amplifier Type 2716 has circuits that protect it against short-circuits, DC, overheating, VHF and clipping (clip limiter may be switched off).

### Wireless Transmission Kit UA 1426

When performing measurements with a sound source, the bandwidth, spectrum, and timing of the driving signal need to be controlled. If the operator is mobile, moving between many measuring positions, a wireless link offers the best method of controlling the driver signal. Using Wireless Transmission Kit UA 1426 a system can be assembled from readily available components.

### Flight Case KE 0358

*Fig. 14 Flight Case KE0358 (left), 2260 Investigator housed in bottom of Flight Case KE0358 (right)*

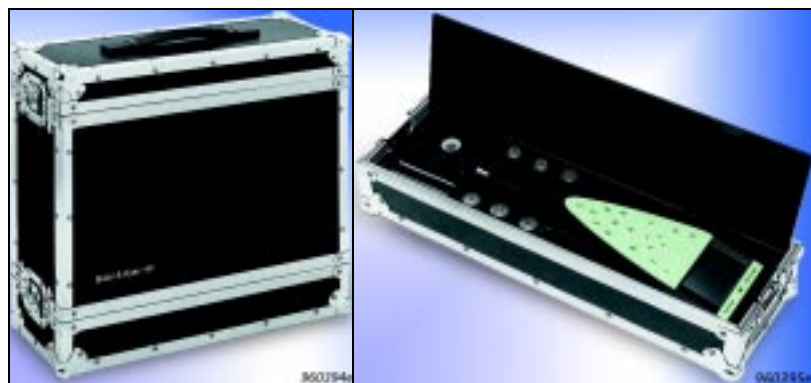

You can safely and conveniently pack and transport several of the items of the measurement chain in Flight Case KE 0358 (see Fig. 14 left)

- 2260 Investigator with accessories
- Power Amplifier Type 2716
- Wireless Transmission Kits UA 1426 and UA 1476
- Assorted cables

The base of the flight case can carry the 2260 Investigator and its accessories (see Fig. 14 right). The main body of the flight case contains the cables and houses the power amplifier.

### Carrying Case KE 0392

*Fig. 15 Carrying Case KE0392*



The OmniSource has an optional, custom designed, carrying case, KE 0392, with shoulder strap (see Fig. 15), for easy storage and transportation. The case is foam lined and provides impact protection for the OmniSource inside.

### Flight Case KE 0365

An optional transportation and storage case, KE0365, is available for the OmniPower (see Fig. 16 left). It is custom designed and features a foam lining to protect the OmniPower, and two handles for carriage.

### Carrying Case KE 0364

To carry the OmniPower tripod Carrying Case KE 0364 (see Fig. 16 right) is equipped with both handles and a shoulder strap.

*Fig. 16 Flight Case KE0365 (left) and Carrying Case KE0364 (right)*





# Complete Systems

Fig. 17 Complete system

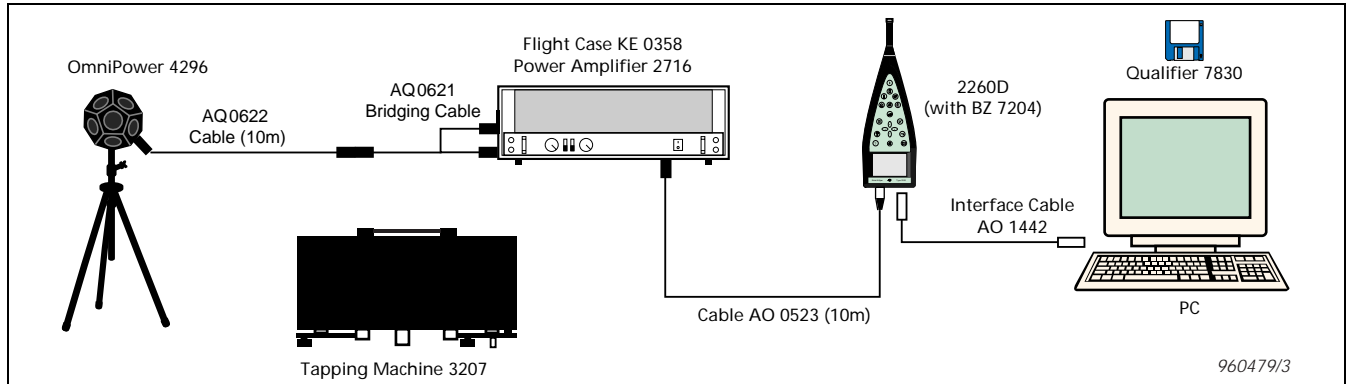

The sound sources mentioned above belong to a range of complete measurement systems from Brüel & Kjær, including power amplifiers, sound level analyzers, and PC-software for documenting power results.

Fig. 18 Sound sources with wireless remote control kits

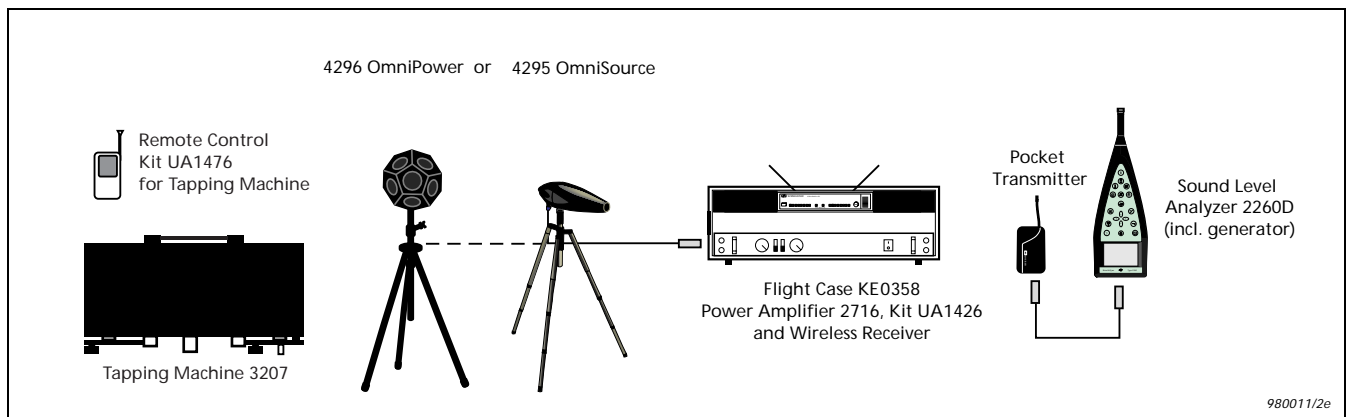

## 2260 Investigator

Fig. 19 Investigator display screen showing a 1/3-octave level spectrum

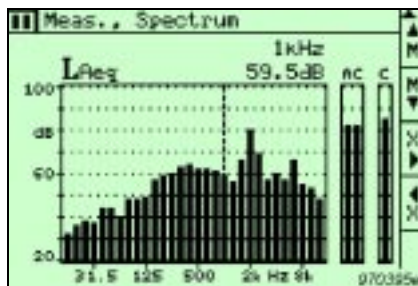

2260 Investigator is a versatile, hand-held, battery-operated, two-channel sound analyzer. Like a personal computer, it is driven by application software for various tasks. The Basic Sound Analysis Software BZ 7210, shipped with 2260 Investigator, converts the instrument into a precision sound level analyzer conforming with IEC and ANSI Type 1 standards. It simultaneously measures a vast array of parameters including 1/3- and 1/1-octave levels and statistics. The measured data can be output to an IBM Proprinter compatible printer or downloaded to a PC using optional Windows® compatible software such as the Noise Explorer™ Type 7815.

## Building Acoustics Software BZ 7204 and BZ 7207

*Fig. 20 2260 Investigator display screen showing a reverberation decay curve*

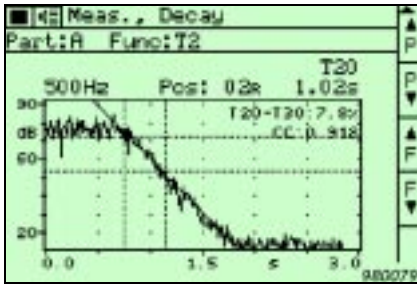

Building Acoustics Software BZ 7204 converts 2260 Investigator into a building acoustics analyzer. It can measure the parameters needed and calculate the weighted sound reduction index according to national and international standards. The frequency range is 50 Hz – 10 kHz in 1/3- or 1/1-octaves. For room acoustics, it measures reverberation time (T20 and T30) for up to 25 positions and displays the decay graphically. Up to 99 decays may be averaged at each position. The average decay time is calculated for all decays. Levels can also be measured, averaged and corrected for background noise. With the BZ 7204, the 2260 also has a built-in noise generator for measurement of sound level and reverberation time. Both pink and white noise can be generated with selectable bandwidth and level.

Room Acoustics Software BZ 7207 is like BZ 7204, but for reverberation time only.

## Qualifier Types 7830 and 7831

*Fig. 21 3D-multispectra, showing reverberation decay curves displayed with Type 7830 Qualifier™ software*

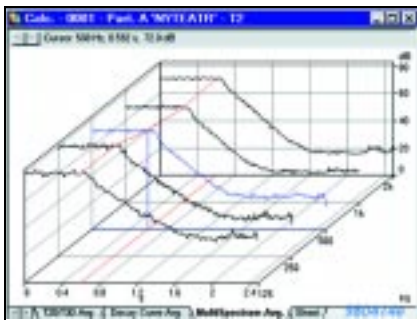

Qualifier Type 7830 is a PC Windows compatible program that takes data from the BZ 7204 and lets you store, view, modify, export and report your measurements. When inspecting the reverberation decay curves, you can graphically adjust the slope line or key in data manually. Reverberation decays can be displayed as 3D-multispectra, providing a complete overview of the frequency dependent reverberation curves. Reverberation time measurements can be averaged in two ways:

- Averaging of reverberation times (T20 and T30)
- Averaging of decay curves (ensemble averaging)

Qualifier Light Type 7831 is like Type 7830, but for reverberation time only (matches BZ 7207)

## Sound Intensity Software BZ 7205

Building acoustic applications such as reduction indices and leakage detection benefit enormously from the sound intensity measurement technique, using 2260 Investigator with sound intensity kit and Intensity Software BZ 7205, as an alternative to a sound pressure based measurement of the apparent sound insulation index  $R'$  for a given partition.

Fig. 22 Mapping the sound reduction to find leakages between studio and control room



This measurement method allows the corrected intensity sound reduction index,  $R_{I,c}$  to be measured. This gives extra information regarding the contribution of various flanking and leakage transmissions. In a traditional sound pressure based measurement you get an apparent sound insulation index  $R'$  which takes every type of transmission into account. However, traditional measurements cannot identify individual transmission paths. But with this application, you can choose specific details of any particular segment of any given partition or surface. If a compound partition is to be studied, e.g., a wall containing a window, the respective corrected intensity sound reduction index,  $R_{I,c}$  for both the wall material and the window can be found.

Fig. 23 2260 Investigator display screen showing the  $R_{I,cw}$  in surface display

Meas., Results					M
$R_{I,cw}$		$R_{I,c}$			C
WALL/EAST:		37.0dB			E
R1,C1:		43.0dB			D
4					▲
3					S
2	48	48	58	52	
1	43	43	43	53	T
	1	2	3	4	

The single-number weighted and corrected intensity sound reduction index,  $R_{I,cw}$  is automatically calculated for each segment and for the surface as a whole.

To create a sound field on one side of the wall (in the source room) you can use the internal white noise generator in 2260 together with Power Amplifier Type 2716 and OmniPower Sound Source Type 4296.

# Compliance with Environmental Standards for 4296 and 4295

<b>Temperature</b>	IEC 60068-2-1 & IEC 60068-2-2: Environmental Testing. Cold and Dry Heat. Operating Temperature: +5 to +40°C (41 to 104°F) Storage Temperature: -25 to +70°C (-13 to 158°F) IEC 60068-2-14: Change of Temperature: -10 to +40°C (2 cycles, 1°C/min.)
<b>Humidity</b>	IEC 60068-2-3: Damp Heat: 93% RH (non-condensing at 40°C (104°F))
<b>Mechanical</b>	Non-operating: IEC 60068-2-6: Vibration: 0.3 mm, 20 m/s <sup>2</sup> , 10-500 Hz IEC 60068-2-27: Shock: 1000 m/s <sup>2</sup> IEC 60068-2-29: Bump: 1000 bumps at 250m/s <sup>2</sup>

## Specifications 4296

<p><b>STANDARDS</b> Conforms to the following: ISO 140-3 ISO 3382 DIN 52210</p> <p><b>NOMINAL IMPEDANCE</b> 6 Ω</p> <p><b>POWER HANDLING</b> 300 W continuous 1000 W short duration (duty cycle 1/10)</p> <p><b>OPERATING FREQUENCY RANGE</b> 100-5000 Hz (1/3-octave band centre frequencies)</p> <p><b>SOUND POWER LEVEL</b> (with Power Amplifier Type 2716, bridge configuration, duty cycle 1/3, 100-3150 Hz pink noise signal)</p>	<p><b>Broadband:</b> 122 dB re 1 pW <b>Spectral:</b> Min. 100 dB/1 pW in each 1/3-octave band</p> <p><b>CONNECTION</b> Four-pin Neutrik Speakon socket, pins 1+ and 1-</p> <p><b>TRIPOD</b> Adjustable to give a speaker height of between 130 and 200 cm</p> <p><b>FLOOR MOUNTING</b> Four rubber feet provided for floor mounting</p> <p><b>DIAMETER</b> <b>Speaker enclosure:</b> 35 cm (13.8")</p> <p><b>WEIGHT</b> <b>Speaker enclosure:</b> 14 kg (30.8 lb) <b>Tripod:</b> 2.4 kg (5.3 lb)</p>
--	--

## Specifications 4295

<p><b>STANDARDS</b> Conforms to the following: ISO 140-3 ISO 3382 DIN 52210 ISO 14257 (Draft)</p> <p><b>OPERATING FREQUENCY RANGE</b> 80-6300 Hz</p> <p><b>NOMINAL IMPEDANCE</b> 6 Ω</p> <p><b>POWER HANDLING</b> 50 W continuous Accepts full power from Power Amplifier Type 2716, one channel, 80-6300 Hz pink noise</p>	<p><b>SOUND POWER LEVEL</b> (with Power Amplifier Type 2716, one channel, 80-6300 Hz pink noise signal) <b>Broadband:</b> 105 dB re 1 pW <b>Spectral:</b> Min. 85 dB in each 1/3-octave band</p> <p><b>CONNECTION</b> Four-pin Neutrik Speakon socket, pins 1+ and 1-</p> <p><b>TRIPOD THREADS (LARGE TYPE)</b> One at rear end, one below centre of gravity</p> <p><b>CARRYING CASE</b> Nylon with padded inlay, adjustable carrying strap</p> <p><b>MECHANICAL SPECIFICATIONS</b> <b>Material:</b> Dense polyurethane plastic, painted black <b>Dimensions:</b> Ø145 × 560 mm (Ø5.7 × 22") <b>Weight:</b> 3.5 kg (7.7 lb)</p>
---	---

# Compliance with Regulations and Environmental Standards for 3207

<b>CE</b>	CE-mark indicates compliance with: EMC Directive, Low Voltage Directive and Machinery Directive.
<b>Safety</b>	EN 61010-1 and IEC 61010-1: Safety requirements for electrical equipment for measurement, control and laboratory use.
<b>EMC Emission</b>	EN 50081-1: Generic emission standard, Part 1: Residential, commercial and light industry. CISPR 22: Radio disturbance characteristics of information technology equipment. Class B limits. FCC Rules, Part 15: Complies with the limits for a Class B digital device
<b>EMC Immunity</b>	EN 50082-2: Generic immunity standard, Part 2: Industrial environment. <b>Note:</b> only guaranteed using accessories listed in this Product Data Sheet.
<b>Temperature</b>	IEC 60068-2-1 & IEC 60068-2-2: Environmental testing. Cold and dry heat. Operating Temperature: 0 to +40°C (32 to 104°F) Storage Temperature: -25 to +70°C (-13 to 158°F)
<b>Humidity</b>	IEC 60068-2-3: Damp heat: 90% RH (non-condensing at 40°C (104°F))
<b>Mechanical</b>	Non-operating: IEC 60068-2-6: Vibration: 0.3 mm, 20 m/s <sup>2</sup> , 10–500 Hz IEC 60068-2-29: Bump: 1000 bumps at 250 m/s <sup>2</sup> IEC 60068-2-27: Shock: 500 m/s <sup>2</sup> , 6 directions
<b>Enclosure</b>	IEC 60529: Protection provided by enclosures: IP 20

## Specifications 3207

<p><b>STANDARDS</b> ISO 140, ISO 717, DIN 52210, BS 5821, ASTM E 492</p> <p><b>HAMMERS</b> Five in line, 100mm between each hammer, single hammer weight 500±12g</p> <p><b>IMPACT FREQUENCY</b> Each hammer operates at 2Hz, tapping frequency for unit is 10±0.5 Hz</p> <p><b>IMPACT DYNAMICS</b> Equivalent free fall height of hammers 40mm, extra drop below impact plane at least 4mm</p> <p><b>REMOTE OPERATION</b> <b>Socket:</b> LEMO 4-pole <b>Pin 1:</b> 0V <b>Pin 2:</b> Power supply for wireless receiver unit <b>Pin 3:</b> TTL-level, +5V for "Operate", 0V for "Stop" <b>Pin 4:</b> For "Operation" connect to Pin 1 <b>Housing:</b> Shield</p> <p><b>REMOTE OPERATION WIRELESS CONTROL KIT UA 1476 (optional)</b> <b>Operating frequency:</b> 434 MHz <b>Transmitter Unit</b> – Connector: LEMO-coaxial socket – Middle pin: +5V for "on"; Outer ring 0V – Batteries: 3 × CR2025 3V Lithium – Dimensions: 85 × 38 × 17 mm (3.4 × 1.5 × 0.7") – Weight: 45 g (1.6 oz) <b>Receiver Unit</b> – Connector: LEMO 4-pole plug with cable For details of pin connections see "Remote Operation" – Power supply: From the Remote control socket</p>	<p>– Dimensions: 120 × 68 × 25 mm (47.2 × 26.8 × 9.8") – Weight: 120 g (4.2 oz)</p> <p><b>BATTERY KIT UA 1477 (optional)</b> <b>Mounting Position:</b> Internally in unit housing <b>Battery Life:</b> 1.5 hours <b>Battery Type:</b> Maintenance free 2 Ah Lead Acid battery <b>Charger Type:</b> Same as mains adaptor (see below) <b>Charging Time:</b> 24 hours for a completely discharged battery</p> <p><b>ON/OFF SWITCH</b> 3 Positions: Remote, Off, On</p> <p><b>MAINS ADAPTOR</b> 10.5–35 V DC, max. 10 W <b>Socket:</b> LEMO coaxial (can also be used as charging socket) <b>Middle pin:</b> +, <b>Outer ring:</b> 0 V <b>Mains Adaptor:</b> Mains adaptor ZG 0400 100–240 V AC input, 24 V DC output, max. 45 W Operating temperature max. +40°C Can also be used to charge optional battery pack</p> <p><b>SUPPORTS</b> 3 extendable and height adjustable feet</p> <p><b>DIMENSIONS</b> W × H × D: 471 × 227 × 141 mm (18.5 × 8.9 × 5.6") (feet retracted) W × H × D: 580 × 227 × 270 mm (22.8 × 8.9 × 10.6") (feet extended) <b>Weight:</b> 10 kg (22 lb) with Mains adaptor</p> <p><b>MAINTENANCE REQUIREMENTS</b> After 24 hrs operation or once a year (which ever comes first), lubricate with the supplied sewing machine oil according to instructions</p>
--	---

# Compliance with Regulations and Environmental Standards for 2716

<b>CE</b>	CE-mark indicates compliance with: EMC Directive and Low Voltage Directive.
<b>Safety</b>	IEC 60065:1985 and Amendment 1:1987 Safety requirements for mains operated electronic and related apparatus for household and similar general use.
<b>EMC emission</b>	EN 55013 and CISPR 13: Radio disturbance of broadcast receivers and associated equipment.
<b>EMC immunity</b>	EN 50082-1: Generic immunity standard, Part 1: Residential, commercial and light industry.
<b>Temperature</b>	IEC 60068-2-1 & IEC 60068-2-2: Environmental testing. Cold and dry heat. Operating temperature: 5°C to +40°C (41 to 104°F) Storage temperature: -25°C to +70°C (-13 to 158°F)
<b>Humidity</b>	IEC 60068-2-3: Damp heat: 90% RH (non-condensing at 40°C (104°F))
<b>Mechanical</b>	Non-operating: IEC 60068-2-6: Vibration: 0.3 mm, 20 m/s <sup>2</sup> , 10–500 Hz IEC 60068-2-29: Bump: 1000 bumps at 250 m/s <sup>2</sup> IEC 60068-2-27: Shock: 500 m/s <sup>2</sup> , 6 directions
<b>Enclosure</b>	IEC 60529: Protection provided by enclosures: IP20

## Specifications 2716

<p><b>MAXIMUM OUTPUT POWER:</b><sup>1</sup></p> <table border="1"> <thead> <tr> <th>Load</th> <th>EIA 1 kHz at clip level<sup>a</sup></th> </tr> </thead> <tbody> <tr> <td>8 Ω stereo</td> <td>100 W</td> </tr> <tr> <td>4 Ω stereo</td> <td>150 W</td> </tr> <tr> <td>2 Ω stereo</td> <td>160 W</td> </tr> <tr> <td>8 Ω bridged</td> <td>300 W</td> </tr> <tr> <td>4 Ω bridged</td> <td>320 W</td> </tr> </tbody> </table> <p>a.Note: continuous power (1 hour) is 1/3 of this</p> <p><b>SPEAKER PROTECTION</b> Each channel is separately protected by a fuse on the positive and negative power supply branch. Electronic short circuit protection with a progressive characteristic is provided. Output power will be progressively reduced below 3Ω. The power amplifier can be run short circuited for a long time without damage and is open circuit and mismatch proof</p> <p><b>POWER BANDWIDTH</b> 12 Hz – 50 kHz</p> <p><b>SLEW RATE</b> 25 V/μs</p> <p><b>OUTPUT IMPEDANCE</b> 0.03 Ω at 1 kHz</p> <p><b>HUM AND NOISE</b> More than 105 dBA below max power</p> <p><b>Channel Separation:</b> 90 dB at 1 kHz 80 dB at 10 kHz</p> <p><small>1.Measured specifications for a 220V regulated AC power supply and at 20°C ambient temperature</small></p>	Load	EIA 1 kHz at clip level <sup>a</sup>	8 Ω stereo	100 W	4 Ω stereo	150 W	2 Ω stereo	160 W	8 Ω bridged	300 W	4 Ω bridged	320 W	<p><b>PHASE AND DELAY</b> ± 2° deviation from perfect delay 150 Hz – 20 kHz 3.8 μs total delay from input to output at 4 Ω</p> <p><b>INPUTS</b> <b>Sensitivity:</b> switchable for full output into 4 Ω, 0.775 or 1.73 Vrms <b>Gain:</b> switchable, 30 dB or 23 dB <b>Impedance:</b> 20 kΩ balanced <b>Common Mode Rejection at 1 kHz:</b> 70 dB</p> <p><b>FRONT PANEL</b> <b>Gain Controls:</b> 2 – channels, A and B <b>Clip Indicator:</b> 2 red LEDs, fast peak and slow release <b>Protection indicator:</b> 2 yellow LEDs, 90°C at heat sink or below 180V AC or &gt;20 kHz at full power <b>Present Indicator:</b> 2 green LEDs, –25 dB at input <b>On indicator:</b> 2 green LEDs, DC rail voltage for channel A/B respectively</p> <p><b>REAR PANEL</b> <b>Input connectors:</b> Two XLR type 3-pin female (pin 2+), and two 1/4" jack <b>Output Connectors:</b> Two Neutrik 4-pin Speakon sockets <b>Switches:</b> – Gain: 30 dB or 23 dB – Link: tandem mono, channel A + B – Rev B: phase reversal of channel B – Clip limiter: On – Off</p> <p><b>POWER REQUIREMENTS</b> <b>Voltage:</b> 180 – 240 V AC (90 – 120 V AC possible) <b>AC-mains Fuse:</b> 4 A slow</p> <p><b>DIMENSIONS</b> W × H × D: 48.3 × 4.4 × 25.5 cm (19.0 × 1.7 × 10.0")</p> <p><b>WEIGHT</b> 7.5 kg (16.5 lb)</p>
Load	EIA 1 kHz at clip level <sup>a</sup>												
8 Ω stereo	100 W												
4 Ω stereo	150 W												
2 Ω stereo	160 W												
8 Ω bridged	300 W												
4 Ω bridged	320 W												



# Specifications KE 0358

<p>Standard 19" rack-mount with a height of 3U (units) = 13.2 cm          Type 2716 must be mounted at bottom of Flight Case          Space for transporting cables and accessories 2U (units) = 8.8 cm          Base contains an inlay for storing and transporting the Investigator Type 2260D and its accessories which comprise:</p> <ul style="list-style-type: none"> <li>• Sound Level Calibrator Type 4231</li> </ul>	<ul style="list-style-type: none"> <li>• Six QB0009 alkaline cells</li> <li>• Two PC-cards</li> </ul> <p>The lid is fitted with a lifting handle</p> <p><b>DIMENSIONS</b>  <b>W × H × D:</b> 53.5 × 17 × 46 cm (21.1 × 6.7 × 18.1")</p> <p><b>WEIGHT</b>          7.5 kg (16.5 lb) empty</p>
---	--

## Ordering Information

<p><b>Type 4296</b> OmniPower Sound Source with tripod  <b>Type 4295</b> OmniSource Sound Source</p> <hr/> <p><b>Optional Accessories</b></p> <p><b>Type 2716</b> Power Amplifier  <b>KE 0358</b> Flight Case  <b>KE 0392</b> Carrying Case for 4295  <b>KE 0365</b> Carrying Case for 4296  <b>KE 0364</b> Carrying Case for tripod of 4296  <b>UA 1426</b> Wireless Transmission Kit  <b>UA 0801</b> Tripod  <b>AO 0523</b> 10 m cable from 2260 to 2716  <b>AO 0524</b> 10 m cable BNC to 2716  <b>AQ 0622</b> 10 m cable from 2716 to 4295, 4296 or equiv.  <b>AQ 0621</b> Bridging Cable for 2716 output (not for Type 4295)</p> <p><b>Type 2260</b> Sound Level Analyzer including BZ 7210  <b>Type 2260D</b> Sound Level Analyzer including BZ 7210, with Building Acoustics Software BZ 7204  <b>Type 2260G</b> Sound Level Analyzer including BZ 7210, with Room Acoustics Software BZ 7207  <b>BZ 7204</b> Building Acoustics Software for Type 2260  <b>BZ 7207</b> Room Acoustics Software for Type 2260  <b>Type 7830</b> Qualifier PC Software for 2260D</p>	<p><b>Type 7831</b> Qualifier Light PC Software for Type 2260G  <b>Type 7815</b> Noise Explorer – data viewing software          For further information, see separate Product Data for the Types mentioned above, and Technical Documentation for UA 1426</p> <hr/> <p><b>Type 3207</b> Tapping Machine</p> <hr/> <p><b>Accessories included with Type 3207</b></p> <p><b>ZG 0400:</b> Mains adaptor (mains cable country dependent)          2 Gauges for drop height adjustment          Oil canister for maintenance</p> <hr/> <p><b>Optional Accessories for Type 3207</b></p> <p><b>AQ 0633</b> 10 m Remote Cable for 2260 to 3207  <b>UA 1476</b> Wireless Remote Control for 3207 (includes AO 1429 Cable for 2260)  <b>UA 1477</b> Battery Kit for 3207  <b>QB 0055</b> Replacement battery for 3207</p>
--	---

Brüel & Kjær reserves the right to change specifications and accessories without notice

