



Advanced Test Equipment Rentals
www.atecorp.com 800-404-ATEC (2832)

Model 5209

Single Phase Lock-in Amplifier

Instruction Manual

219567-A-MNL-G

Notice

This equipment generates, uses, and can radiate radio-frequency energy and, if not installed and used in accordance with this manual, may cause interference to radio communications. As temporarily permitted by regulation, operation of this equipment in a residential area is likely to cause interference, in which case the user at his own facility will be required to take whatever measures may be required to correct the interference.

Company Names

SIGNAL RECOVERY is part of Advanced Measurement Technology, Inc, a division of AMETEK, Inc. It includes the businesses formerly trading as EG&G Princeton Applied Research, EG&G Instruments (Signal Recovery), EG&G Signal Recovery and PerkinElmer Instruments (Signal Recovery)

Declaration of Conformity

This product conforms to EC Directives 89/336/EEC Electromagnetic Compatibility Directive, amended by 92/31/EEC and 93/68/EEC, and Low Voltage Directive 73/23/EEC amended by 93/68/EEC.

This product has been designed in conformance with the following IEC/EN standards:

EMC: BS EN55011 (1991) Group 1, Class A (CSPIR 11:1990)
 BS EN50082-1 (1992):
 IEC 801-2:1991
 IEC 801-3:1994
 IEC 801-4:1988

Safety: BS EN61010-1: 1993 (IEC 1010-1:1990+A1:1992)

Trademarks

AMETEK® and the **AMETEK**® and **A** logos are registered trademarks of AMETEK, Inc.

IBM is a registered trademark of International Business Machines Corporation

Microsoft, MS-DOS, QBASIC, GWBASIC and QuickBasic are registered trademarks and Windows is a trademark of Microsoft Corporation

National Instruments is a registered trademark of National Instruments Corporation

Table of Contents

Chapter One, Introduction

1.1 How to Use This Manual	1-1
1.2 What is a Lock-in Amplifier?	1-2
1.3 Key Specifications and Benefits.....	1-3

Chapter Two, Installation & Initial Checks

2.1 Installation.....	2-1
2.1.01 Introduction.....	2-1
2.1.02 Rack Mounting.....	2-1
2.1.03 Inspection.....	2-1
2.1.04 Line Cord Plug.....	2-2
2.1.05 Line Voltage Selection and Line Fuses	2-2
2.2 Initial Checks.....	2-3
2.2.01 Introduction.....	2-3
2.2.02 Procedure.....	2-4

Chapter Three, Technical Description

3.1 Introduction	3-1
3.2 Operating Modes.....	3-1
3.2.01 Introduction.....	3-1
3.2.02 Sine-Wave / Square-Wave Response.....	3-1
3.2.03 2F Mode	3-1
3.2.04 Internal / External Reference Mode.....	3-1
3.3 Principles of Operation.....	3-2
3.3.01 Block Diagram	3-2
3.3.02 Signal-Channel Inputs	3-2
3.3.03 Line Frequency Rejection Filter	3-3
3.3.04 Main Filter.....	3-4
3.3.05 Signal Monitor Output.....	3-5
3.3.06 Reference Channel.....	3-6
3.3.07 Internal Oscillator.....	3-6
3.3.08 Reference Monitor.....	3-7
3.3.09 Phase Shifter	3-8
3.3.10 Demodulator - Introduction.....	3-9
3.3.11 Demodulator - Squarewave Mode	3-9
3.3.12 Demodulator - Walsh Mode.....	3-9
3.3.13 PSD Monitor Output	3-10
3.3.14 Output Filter - Operation.....	3-11
3.3.15 Output Filter - Output Offset & Expand	3-12
3.3.16 Dynamic Reserve and Output Stability.....	3-13
3.3.17 Main Analog to Digital Converter.....	3-15
3.3.18 Output Processor - General.....	3-16
3.3.19 Output Processor - Noise Measurements.....	3-16

TABLE OF CONTENTS

3.3.20 Analog Panel Meter	3-18
3.3.21 OUT Analog Output	3-19
3.3.22 Auxiliary Analog Inputs and Outputs (ADCs and DACs)	3-19
3.3.23 Overload Detection	3-19
3.3.24 Main Microprocessor - General.....	3-20
3.3.25 Main Microprocessor - Auto Functions	3-20
3.4 General	3-22
3.4.01 Accuracy	3-22
3.4.02 Power-up Defaults	3-23

Chapter Four, Front and Rear Panels

4.1 Front Panel.....	4-1
4.1.01 Connectors.....	4-1
4.1.02 Keys	4-3
4.1.03 Control Setting Indicators	4-4
4.1.04 Overload Indicators.....	4-4
4.1.05 LCD Displays.....	4-4
4.1.06 Analog Panel Meter	4-4
4.2 Rear Panel.....	4-5
4.2.01 Line Power Input Assembly	4-5
4.2.02 RS232 Connector.....	4-5
4.2.03 GPIB Connector	4-5
4.2.04 PREAMP POWER Connector	4-5
4.2.05 DAC AUX OUT CH1 and CH2 Connectors.....	4-5
4.2.06 ADC AUX INPUTS CH1 - CH4 Connectors	4-6
4.2.07 TTL REF OUT Connector.....	4-6
4.2.08 ADC EXT TRIG IN Connector.....	4-6
4.2.09 PSD MONITOR Connector	4-6

Chapter Five, Front Panel Operation

5.1 Introduction.....	5-1
5.2 SENSITIVITY Group	5-1
5.2.01 A and B/I VIR GND BNC Connectors	5-1
5.2.02 A Key.....	5-2
5.2.03 A-B Key	5-2
5.2.04 10^6 V/A and 10^8 V/A Keys.....	5-2
5.2.05 FLOAT/GROUND Key.....	5-2
5.2.06 SENSITIVITY ▲ and ▼ Keys.....	5-2
5.2.07 VERNIER/NORMALIZE Key	5-3
5.2.08 OVLD Indicator.....	5-3
5.3 FILTERS Group	5-4
5.3.01 MODE Key	5-4
5.3.02 SET-FREQ/AUTO Key.....	5-5
5.3.03 LINE REJECT Key	5-6
5.3.04 SIG MON BNC Connector	5-6
5.4 TUNING Group.....	5-7

5.4.01 TUNING Select/AUTO PHASE Key.....	5-7
5.4.02 TUNING ▲ and ▼ PARAMETER Keys.....	5-8
5.4.03 +90° Key	5-8
5.5 AUTO Key	5-9
5.5.01 Auto-Sensitivity	5-9
5.5.02 Auto-Normalize.....	5-9
5.5.03 Auto-Tune.....	5-9
5.5.04 Auto-Phase.....	5-10
5.5.05 Auto-Measure	5-10
5.5.06 Auto-Offset.....	5-10
5.6 Trigger Conversion Mode Control.....	5-10
5.7 Analog Panel Meter.....	5-12
5.8 REFERENCE Group	5-12
5.8.01 INT Key.....	5-12
5.8.02 2F Key.....	5-13
5.8.03 UNLK indicator	5-13
5.8.04 AC IN connector	5-13
5.8.05 TTL IN connector	5-13
5.8.06 OSC OUT connector	5-13
5.9 OUTPUT Group	5-14
5.9.01 TIME CONSTANT ▲ and ▼ VALUE Keys.....	5-14
5.9.02 SLOPE/RS232 Key.....	5-14
5.9.03 DYN RES/GPIB Key	5-15
5.9.04 OFFSET/AUTO Key	5-15
5.9.05 OUTPUT LCD ▲ and ▼ keys.....	5-16
5.9.06 EXPAND Key.....	5-16
5.9.07 DISPLAY/LIGHTS Key	5-16
5.9.08 OVLD Indicator	5-21
5.9.09 OUT Connector.....	5-21
5.10 Interface Group.....	5-21
5.10.01 ACTIVE Indicator.....	5-21
5.10.02 LOCAL Key	5-21
5.10.03 CONFIG Key.....	5-22
5.11 POWER on/off key	5-25
5.12 Typical Lock-in Amplifier Experiment.....	5-25

Chapter Six, Computer Operation

6.1 Introduction	6-1
6.2 Capabilities.....	6-1
6.2.01 General	6-1
6.2.02 Oscillator amplitude - additional output setting	6-1
6.2.03 Automatic ADC Converter Correction	6-1
6.3 RS232 and GPIB Operation	6-1
6.3.01 Introduction.....	6-1
6.3.02 RS232 Interface - General Features	6-2
6.3.03 Choice of Baud Rate.....	6-3
6.3.04 Choice of Number of Data Bits.....	6-3
6.3.05 Choice of Parity Check Option	6-3

TABLE OF CONTENTS

6.3.06 GPIB Interface General Features.....	6-3
6.3.07 Handshaking and Echoes.....	6-4
6.3.08 Terminators	6-5
6.3.09 Command Format	6-6
6.3.10 Delimiters	6-6
6.3.11 Compound Commands	6-6
6.3.12 Status Byte, Prompts and Overload Byte	6-6
6.3.13 Service Requests.....	6-8
6.4 Command Descriptions.....	6-8
6.4.01 Signal Channel.....	6-9
6.4.02 Signal Channel Filters.....	6-10
6.4.03 Reference Channel	6-11
6.4.04 Signal Channel Output Filter.....	6-12
6.4.05 Signal Channel Output Amplifier	6-12
6.4.06 Instrument Outputs	6-13
6.4.07 Internal Oscillator	6-14
6.4.08 Auxiliary Outputs	6-15
6.4.09 Auxiliary Inputs.....	6-15
6.4.10 Computer Interfaces (RS232 and GPIB).....	6-16
6.4.11 Instrument Identification	6-18
6.4.12 Front Panel	6-18
6.4.13 Calibration.....	6-20
6.5 Programming Examples.....	6-20
6.5.01 Introduction	6-20
6.5.02 Converting Output Values to Voltages and Currents.....	6-20
6.5.03 Basic Signal Recovery	6-21
6.5.04 Frequency Response Measurement	6-21

Appendix A, Specifications

Appendix B, Pinouts

B1 RS232 Connector Pinout	B-1
B2 Preamplifier Power Connector Pinout.....	B-1

Appendix C, Demonstration Programs

C1 Simple Terminal Emulator	C-1
C2 RS232 Control Program with Handshakes.....	C-1
C3 GPIB User Interface Program	C-3

Appendix D, Cable Diagrams

D1 RS232 Cable Diagrams	D1
-------------------------------	----

Appendix E, Alphabetical Listing of Commands

Index

Warranty.....End of Manual

1.1 How to Use This Manual

This manual gives detailed instructions for setting up and operating the **SIGNAL RECOVERY** Model 5209 single phase lock-in amplifier. It is split into the following chapters:-

Chapter 1 - Introduction

Provides an introduction to the manual, briefly describes what a lock-in amplifier is and the types of measurements it may be used for, and lists the major specifications of the model 5209.

Chapter 2 - Installation and Initial Checks

Describes how to install the instrument and gives a simple test procedure which may be used to check that the unit has arrived in full working order.

Chapter 3 - Technical Description

Provides an outline description of the design of the instrument and discusses the effect of the various controls. A good understanding of the design will enable the user to get the best possible performance from the unit.

Chapter 4 - Front and Rear Panels

Describes the connectors, controls and indicators which are found on the unit and which are referred to in the subsequent chapters.

Chapter 5 - Front Panel Operation

Describes the capabilities of the instrument when used as a manually operated unit, and shows how to operate it using the front panel controls.

Chapter 6 - Computer Operation

This chapter provides detailed information on operating the instrument from a computer over either the GPIB (IEEE-488) or RS232 interfaces. It includes information on how to establish communications, the functions available, the command syntax and a detailed command listing.

Appendix A

Gives the detailed specifications of the unit.

Appendix B

Details the pinouts of the multi-way connectors on the rear panel.

Appendix C

Lists three simple terminal programs which may be used as the basis for more complex user-written programs.

Appendix D

Shows the connection diagrams for suitable RS232 null-modem cables to couple the unit to an IBM-PC or 100% compatible computer.

Appendix E

Gives an alphabetical listing of the computer commands for easy reference.

New users are recommended to unpack the instrument and carry out the procedure in chapter 2 to check that it is working satisfactorily. They should then make themselves familiar with the information in chapters 3, 4 and 5, even if they intend that the unit will eventually be used under computer control. Only when they are fully conversant with operation from the front panel should they then turn to chapter 6 for information on how to use the instrument remotely. Once the structure of the computer commands is familiar, appendix E will prove convenient as it provides a complete alphabetical listing of these commands in a single easy-to-use section.

1.2 What is a Lock-in Amplifier?

In its most basic form the lock-in amplifier is an instrument with dual capability. It can recover signals in the presence of an overwhelming noise background or alternatively it can provide high resolution measurements of relatively clean signals over several orders of magnitude and frequency.

Modern instruments, such as the model 5209, offer far more than these two basic characteristics and it is this increased capability which has led to their acceptance in many fields of scientific research, such as optics, electrochemistry, materials science, fundamental physics and electrical engineering, as units which can provide the optimum solution to a wide range of measurement problems.

The model 5209 lock-in amplifier can function as a:-

- AC Signal Recovery Instrument
- Frequency Meter
- Oscillator
- Noise Measurement Unit

These characteristics, all available in a single compact unit, make it an invaluable addition to any laboratory.

1.3 Key Specifications and Benefits

The **SIGNAL RECOVERY** Model 5209 represents the ultimate in analog lock-in amplifier technology, and offers:-

- Frequency range: 0.5 Hz to 120 kHz
- Voltage sensitivity: 100 nV to 3 V full-scale
- Current input mode sensitivities: 10 fA to 300 nA full-scale
10 fA to 3 μ A full-scale
- Line frequency rejection filter
- Fundamental (sine wave) or square-wave response modes
- Very low phase noise of $< 0.005^\circ$ rms.
- 3½-digit output readings
- Oscillator with variable amplitude and frequency
- Output time constants from 1 ms to 3 ks with 6 or 12 dB/octave roll-off
- Four external auxiliary ADC inputs
- Two external auxiliary DAC outputs
- Full range of auto-modes
- Standard GPIB (IEEE-488) and RS232 interfaces
- Two liquid crystal displays (LCD) and an analog panel meter for control and display of instrument outputs

2.1 Installation

2.1.01 Introduction

Installation of the model 5209 in the laboratory or on the production line is very simple. Because of its low power consumption, the model 5209 does not incorporate forced-air ventilation. It can be operated on almost any laboratory bench or be rack mounted using the supplied accessory kit, at the user's convenience. With an ambient operating temperature range of 0°C to 35°C, it is highly tolerant to environmental variables, needing only to be protected from exposure to corrosive agents and liquids.

2.1.02 Rack Mounting

Two rack-mounting handles are supplied with the instrument which are fitted as follows:-

- 1) Turn the instrument off and disconnect the line power cord.
- 2) Using a suitable screwdriver, remove the two screws securing each of the two end-cheeks on each side of the front panel.
- 3) Fit the rack mounting handles using the same screws.
- 4) The four instrument feet may be removed if required, by removing the four screws securing them. However, if this is done, the bottom cover must be re-fixed in position using the shorter screws supplied with the rack-mounting handles.

CAUTION:- When the feet are removed, the maximum screw length that can be used is ¼" (6 mm). Use of longer screws could cause a short circuit that would damage the instrument and possibly create a dangerous shock hazard.

- 5) The instrument may now be mounted directly in a 19 inch rack using four securing bolts (not supplied)
- 6) Mechanical support should be provided for the rear of the instrument.

2.1.03 Inspection

Upon receipt the model 5209 Lock-in Amplifier should be inspected for shipping damage. If any is noted, **SIGNAL RECOVERY** should be notified immediately and a claim filed with the carrier. The shipping container should be saved for inspection by the carrier.

2.1.04 Line Cord Plug

A standard IEC 320 socket is mounted on the rear panel of the instrument and a suitable line cord is supplied.

2.1.05 Line Voltage Selection and Line Fuses

Before plugging in the line cord, ensure that the model 5209 is set to the voltage of the AC power supply to be used.

A detailed discussion of how to check and, if necessary, change the line voltage setting follows.

CAUTION: The model 5209 may be damaged if the line voltage is set for 110 V AC operation and it is turned on with 220 V AC applied to the power input connector.

The model 5209 can operate from any one of four different line voltage ranges, 90-110 V, 110-130 V, 200-240 V, and 220-260 V, at 50-60 Hz. The change from one range to another is made by repositioning a plug-in voltage selector circuit card located in the rear-panel power input assembly.

Observing the instrument from the rear, note the clear-plastic door immediately adjacent to the power cord connector (Figure 2-1). When the power cord is disconnected from the rear-panel connector, the plastic door is free to slide to the left, giving access to the fuse and to the voltage selector circuit card. The selector card is located at the lower edge of the fuse compartment. A number printed on the upper surface of the selector card is visible without removing the card. The number is somewhat obscured by the fuse but can be read at the correct viewing angle. This number indicates the selected nominal line voltage. There are four numbers on the card, but only one is visible. In other words, the card can be inserted in one of four different positions, and a different number can be read in each. Table 2-1 indicates the actual line voltage range for each number. If the number showing is incorrect for the prevailing line voltage, the card will have to be repositioned, as follows.

The first step is to remove the fuse. When the lever labeled FUSE PULL is rotated out and towards the left, the fuse will lift so that it can be easily removed. At the front center of the circuit card is a small hole that serves as a convenient pry point. A small screwdriver or other tool can be used as an aid in removing the board. With the board removed, four numbers become visible: 100, 120, 220, and 240. Orient the board until the required number (Table 2-1) will be visible when the board is inserted. Then insert the board into its connector. The selected number should be the only one that shows. Ensure that the board is securely seated in its connector.

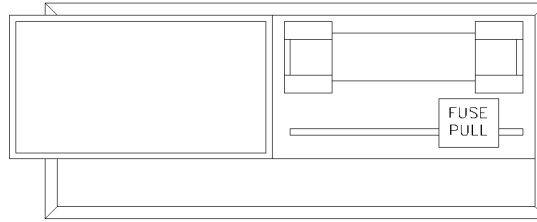

Figure 2-1. Power Input Assembly

Next check the fuse rating. For operation from a nominal line voltage of 120 V, use a slow-blow fuse rated at 1.0 A (voltage rating 250 V or higher). For operation from a nominal line voltage of 220 V, use a slow-blow fuse rated at 0.5 A (voltage rating of 250 V or higher). When the proper fuse has been installed, slide the plastic door back over the fuse compartment so that the power cord can be reconnected. Ensure that only fuses with the required current rating and of the specified type are used for replacement. The use of makeshift fuses and the short-circuiting of the fuse holder is prohibited and potentially dangerous.

VISIBLE #	VOLTAGE RANGE		
100	90	-	110 V
120	110	-	130 V
220	200	-	240 V
240	220	-	260 V

Table 2-1, Range vs. Card Position

2.2 Initial Checks

2.2.01 Introduction

The following procedure checks the performance of the model 5209. In general, this procedure should be carried out after inspecting the instrument for obvious shipping damage.

NOTE: Any damage must be reported to the carrier and to **SIGNAL RECOVERY** immediately; take care to save the shipping container for inspection by the carrier.

Note that this procedure is intended to demonstrate that the instrument has arrived in good working order, not that it meets specifications. Each instrument receives a careful and thorough checkout before leaving the factory, and normally, if no shipping damage has occurred, will perform within the limits of the quoted specifications. If any problems are encountered in carrying out these checks, contact **SIGNAL RECOVERY** or the nearest authorized representative for assistance.

2.2.02 Procedure

- 1) Ensure that the Model 5209 is set to the line voltage of the power source (See Section 2.1.05 for details).
- 2) With the **POWER** switch set to off (push button at lower right-hand corner of front panel in the out position), plug the line cord into an appropriate source of power.
- 3) Turn on the power.
- 4) Check the instrument is in the LOCAL state (pushbutton in upper right-hand corner of the front panel). The **REMOTE** indicator directly above the pushbutton should NOT be lit.
- 5) Set the Model 5209 controls as follows.

SENSITIVITY Group

INPUT SELECT: **A** key depressed

FLOAT/GROUND: **FLOAT** key depressed

SENSITIVITY: Use the **▲** and **▼** keys until the legend **1 V** is lit

FILTERS Group

MODE: **BP** (BANDPASS)

SET FREQ: **TRACK** illuminated

TUNING Group

SELECTION: **OSC F** (internal oscillator frequency)

REFERENCE Group

REFERENCE MODE: **INT** (internal)

REFERENCE FREQUENCY MODE: **F** (**2F** extinguished)

OUTPUT Group

TIME CONSTANT: Use the **▲** and **▼** keys until the legend **100 ms** is lit.

SLOPE: **6 dB** indicator lit

DYN RESERVE: **HI STAB**

OFFSET: Off (“**ON**” indicator extinguished)

EXPAND: Off (“**×10**” indicator extinguished)

DISPLAY: **% FS**

CONFIG: Off (“**CONFIG**” indicator extinguished)

- 6) Connect a cable between the **OSC OUT** connector and the **A** input connector.
- 7) The **TUNING** display should indicate the oscillator frequency (display function **OSC F** selected in step 5). Use the **PARAMETER ▲** and **▼** keys to change the frequency to 1.000 kHz.

- 8) Press the **TUNING** Select key (identified by the red "**AUTO PHASE**" label beneath it) until **OSC LVL** is lit. The display will indicate the amplitude of the oscillator output.
- 9) Use the **PARAMETER** ▲ and ▼ keys to set the output amplitude to 0.500 V.
- 10) Press the red **AUTO** key and then the **MEASURE** key. This will initiate an auto-measure cycle. Automatically, the 5209 will:
 - a) Tune the band-pass signal channel filter to 1.000 kHz.
 - b) Set the full-scale sensitivity to 1 V range (already selected).
 - c) Adjust the reference phase for maximum output.

On completion of the auto-measure cycle (the red **AUTO** indicator will extinguish), both the analog meter and the **OUTPUT** group digital display should indicate a value close to 50% of full scale (input signal level of 0.500 V rms with selected sensitivity of 1 V rms).

This completes the initial checks. If the indicated results were obtained, the user can be reasonably sure that the unit incurred no hidden damage in shipment and is in good working order.

3.1 Introduction

The model 5209 lock-in amplifier is a sophisticated instrument with many capabilities beyond those found in lower-cost instruments. This chapter discusses the various operating modes provided and then describes the design of the instrument by considering it as a series of functional blocks. In addition to describing how each block operates, each section also includes information on the effect of the various controls.

3.2 Operating Modes

3.2.01 Introduction

The model 5209 incorporates a number of different operating modes which are referred to in the following technical description, so in order to help the reader's understanding they are defined here.

3.2.02 Sine-Wave / Square-Wave Response

The fundamental purpose of a lock-in amplifier is to measure the amplitude of the component of the input voltage or current signal which is at the same frequency as that of the instrument's reference frequency. If the instrument gives an output only for signals at the reference frequency, then it is said to be *sine-wave* or *fundamental* responding.

In cases where the input signal takes the form of a square wave, for example if it is generated by detecting an optical signal passing through a rotating-blade light chopper, then it also contains components at odd harmonics of the fundamental frequency. Such harmonics contain useful information, and so if the instrument can be made to respond to them as well, a larger output will result. Instruments that respond in this way are known as *square-wave* responding units.

The model 5209 may operate in either mode, allowing the best mode to be chosen for all types of input signal.

3.2.03 2F Mode

Normally, a lock-in amplifier measures the applied signal at the reference frequency. However, in some applications such as Auger Spectroscopy and amplifier characterization, it is useful to be able to make measurements at twice the reference frequency. The model 5209 may be set to a "2F" mode which allows this, with the only restriction in performance being that the 2F signal cannot be greater than the upper frequency limit of the instrument, which is 120 kHz.

3.2.04 Internal / External Reference Mode

In the internal reference mode, the instrument's reference channel is driven by a signal derived from its internal oscillator. The oscillator signal is used to drive the

experiment, and the instrument measures the response of the experiment to this stimulation.

In the external reference mode, the experiment includes some device, for example an optical chopper, which generates a reference frequency which is applied to the lock-in amplifier's external reference input. The instrument's reference channel "locks" to this signal and uses it to measure the applied input signal.

3.3 Principles of Operation

3.3.01 Block Diagram

The model 5209 utilizes low-noise analog signal processing circuitry and a 68000 series microprocessor to achieve its specifications. A block diagram of the instrument is shown in figure 3-1, and the sections that follow describe how each functional block operates and the effect it has on the instrument's performance.

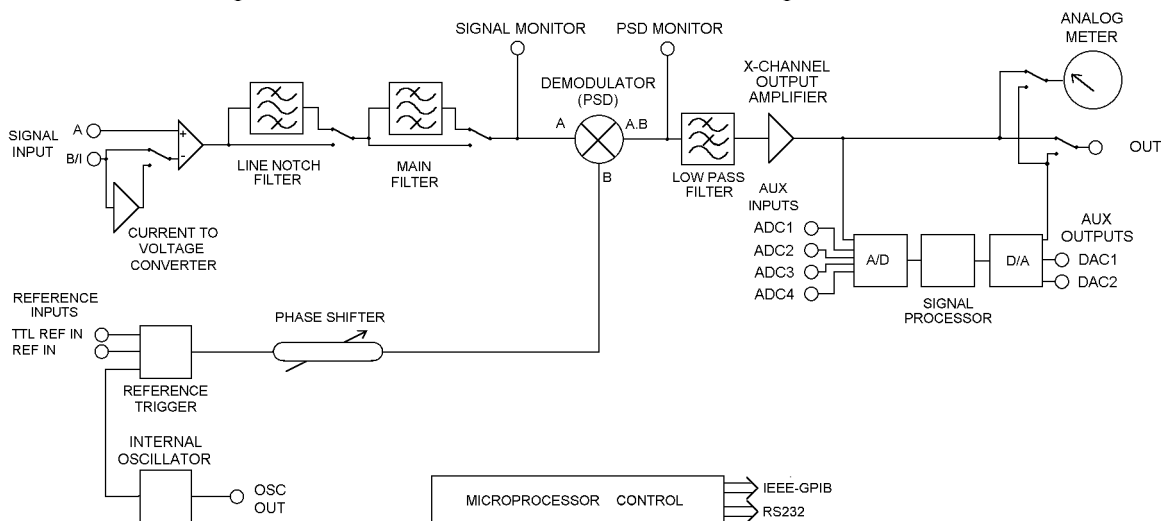

Figure 3-1, Model 5209 - Block Diagram

3.3.02 Signal-Channel Inputs

The signal input amplifier can be configured for either single-ended or differential voltage mode operation, or single-ended current mode operation. In voltage mode a choice of AC or DC coupling is available. In current mode two conversion gains may be selected to give optimum matching to the signal input. In both modes the input connector shells may be either floated via a 1 k Ω resistor or grounded to the instrument's chassis ground. These various features are discussed in the following paragraphs.

Input Connector Selection, A / A - B

When set to the **A** mode, the lock-in amplifier measures the voltage between the center and the shell of the **A** input BNC connector, whereas when set to the **A-B** mode it measures the difference in voltage between the center pins of the **A** and **B/I VIR GND**

input BNC connectors.

The latter, differential, mode is often used to eliminate ground loops, although it is worth noting that at very low signal levels it may be possible to make a substantial reduction in unwanted offsets by using this mode, with a short-circuit terminator on the **B/I VIR GND** connector, rather than by simply using the **A** input mode.

The specification defined as the Common Mode Rejection Ratio, CMRR, defines how well the instrument rejects common mode signals applied to the **A** and **B/I VIR GND** inputs when operating in differential input mode. It is usually given in decibels. Hence a specification of > 100 dB implies that a common mode signal (i.e. a signal simultaneously applied to both **A** and **B/I VIR GND** inputs) of 1 V will give rise to less than 10 μ V of signal out of the input amplifier.

Input Connector Shell Ground / Float

The input connector shells may be connected either directly to the instrument's chassis ground or they can be floated by being connected via a 1 k Ω resistor. When in the float mode, the presence of this resistor substantially reduces the problems which often occur in low-level lock-in amplifier measurements due to ground loops.

Input Signal Selection, V / I

Although the voltage mode input is most commonly used, a current to voltage converter may be switched into use to provide current mode input capability, in which case the signal is connected to the **B/I VIR GND** connector. High impedance sources (> 100 k Ω) are inherently current sources and typically need to be measured with a low impedance current mode input. Even when dealing with a voltage source in series with a high impedance, the use of the current mode input may provide advantages in terms of improved bandwidth and immunity from the effects of cable capacitance.

The converter may be set to **10⁶ V/A** or **10⁸ V/A** conversion settings, but it should be noted that the -3 dB bandwidth when used in current input mode is much lower than that in voltage input mode. Better performance can be achieved using a separate current preamplifier, such as the **SIGNAL RECOVERY** model 5182.

3.3.03 Line Frequency Rejection Filter

Following the signal input amplifier, there is an option to pass the signal through a line frequency rejection filter, which is designed to give greater than 34 dB of attenuation within a $\pm 1\%$ range of the power line frequencies of 50 Hz or 60 Hz and their second harmonics at 100 Hz or 120 Hz.

The line frequency filter is supplied set to match the line frequency of the country of destination, but it will be appreciated that if a unit is moved from a 50 Hz area to a 60 Hz area then the filter will need to be adjusted. This is done by changing the values of several internal resistors, for which purpose the unit should be returned to a **SIGNAL RECOVERY** service facility. Changing the filter frequency setting is not covered under the terms of the instrument's warranty.

3.3.04 Main Filter

The main filter has two functions. First, it prevents large interfering signals, which would otherwise cause overload and non-linear operation, from reaching the phase sensitive detectors (PSDs). Consequently, it increases the instrument's *dynamic reserve* (discussed later in section 3.3.16). Second, in conjunction with the special Walsh mode of operation of the demodulators, it causes the instrument to behave as if it were a sine-wave responding unit. The filter prevents signals at the harmonics of the reference frequency higher than the seventh from reaching the demodulator, while the Walsh demodulator rejects the third and fifth harmonics.

The main signal channel filter has four possible settings, as follows:-

Flat

In the flat mode of operation, the main filter is switched out of use and the demodulators are set to square-wave mode, giving an overall square-wave instrument response. Odd harmonics at the reference frequency of an applied square wave contribute to the output by a ratio $1/n$, where “ n ” is the order of the harmonic. Consequently, if the input signal is a square wave, the output will be about 23% higher with the flat mode selected than with the other settings, since in the latter cases only the fundamental frequency component of the square wave contributes to the output.

Notch

When the main filter is set to notch mode, very deep attenuation of signals at the set filter frequency is achieved. The mode is primarily intended to remove interference concentrated at a specific frequency or band of frequencies, such as when measuring signals at twice the reference frequency which also contain strong components at the reference frequency. In this case, the instrument is set to the 2F reference mode and the notch filter frequency is set to the reference frequency.

Low-Pass

In the low-pass setting, the filter is configured to give maximum rejection of frequencies above the set filter frequency, giving the best possible harmonic rejection. This setting is usually used when the interference is concentrated at frequencies higher than the reference frequency.

Bandpass

In the bandpass setting, the filter still rejects frequencies above the set filter frequency, but with less attenuation than in the low-pass case, but in addition it also rejects signals at lower frequencies. This setting is usually used when the interference is concentrated at frequencies lower than the reference frequency.

The filter is composed of a fourth-order stage with Q-factor of 2, which gives much better rejection of unwanted signals than a second-order stage with higher Q-factor, while introducing less phase shift for signals at the reference frequency.

The filter frequency can be tuned manually or can automatically be set to track the reference frequency, over the full frequency range of the instrument. The tracking mode is useful in swept-frequency experiments, but if the reference frequency is stable

then better performance will be achieved by setting the filter frequency control to the manual mode.

NOTE: *When the reference mode is in the “F” setting, the filter tracking mode sets the filter frequency to the reference frequency for all filter settings. When the “2F” mode is selected, filter tracking mode sets the filter frequency to the twice the reference frequency for the Bandpass and Low-Pass filter modes, and to the reference frequency for the Notch filter mode.*

3.3.05 Signal Monitor Output

The analog signal following the input amplifiers, line frequency rejection filter and main signal channel filter is available at the front-panel **SIG MON** BNC connector. The gain between the **A** or **A-B** input connectors and this connector depends on the full-scale sensitivity range, on the main signal channel filter setting and on the setting of the dynamic reserve control, with the nominal values being given in table 3-1

Full-scale Sensitivity	Gain at Dynamic Reserve Setting		
	High Stability	Normal	High Reserve
3 V	0.3332	0.3332	0.3332
1 V	1	1	1
300 mV	3.332	3.332	3.332
100 mV	10	10	10
30 mV	33.32	3.332	3.332
10 mV	100	10	10
3 mV	333.2	33.32	3.332
1 mV	1000	100	10
300 μ V	3332	333.2	33.32
100 μ V	10000	1000	100.0
30 μ V	33320	3332	333.2
10 μ V	100000	10000	1000
3 μ V	333200	33320	3332
1 μ V	1000000	100000	10000
300 nV	333200	333200	33320
100 nV	1000000	1000000	100000

Table 3-1, Signal Channel Gain, Nominal, A or A-B Input To Sig Mon Output (Bandpass, Low-Pass or Notch Filter Modes)

When the main signal channel filter is inactive, i.e. set to flat, the given figures should be multiplied by 0.790

The signal monitor output is unbuffered, and has an output impedance of 1 k Ω . Internal noise and switching spikes may be present. The higher the reserve setting, the greater their amplitude will be relative to that of the signal.

The output of the signal channel is fed to the signal inputs of the phase sensitive detector (PSD). Before discussing this in detail and the output stages that follow, the reference channel that provides the other input to the demodulator will be described.

3.3.06 Reference Channel

The reference channel in the instrument is responsible for implementing the reference trigger/phase-locked loop and phase shifter circuits and providing switching waveforms to the phase sensitive detector.

There are two reference modes, as follows:

External Reference Mode

In external reference mode the reference source is applied to either a general purpose input, designed to accept virtually any periodic waveform with a 50:50 mark-space ratio and of suitable amplitude, or to a TTL-logic level input.

Wherever possible, the TTL reference input should be used since it gives better phase accuracy.

Internal Reference Mode

With internal reference operation the output of the instrument's internal oscillator is internally coupled to the reference channel.

Regardless of the reference mode used, the reference circuits measure the actual reference frequency using the instrument's internal crystal oscillator clock. Above 2 kHz, the unit counts the number of reference cycles in a period of 0.5 s giving a measurement time of 0.5 s. Below 2 kHz it counts the number of cycles of a 4 MHz clock in one reference period and so the measurement time is inversely proportional to the frequency, with the longest time being 2 s at the lowest possible frequency of 0.5 Hz.

Although this measurement time is not important in most experiments, in those cases where the reference frequency is being stepped to a series of values, perhaps under computer control, it should be allowed for in determining the time needed to obtain an accurate measure of frequency following a change.

The time needed for the reference circuits to acquire lock following a change in frequency, the *lock acquisition time*, is nominally 2 reference periods plus 100 ms. The red front-panel reference **UNLK** indicator lights whenever the reference circuit is not locked.

Within the reference circuits, the full operating frequency range of the instrument is split into five bands, with changeover points at 2 Hz, 20 Hz, 200 Hz, 2 kHz and 20 kHz. Normally, these need not concern the user, but if the reference frequency is stepped through one of them then the instrument will briefly lose lock, requiring that a time equal to the lock acquisition time plus the output filter settling time be allowed for to obtain a steady output reading.

When the instrument is switched to 2F mode the reference circuits run at twice the applied reference frequency, with an upper limit for the latter of 60 kHz.

3.3.07 Internal Oscillator

In common with many other lock-in amplifiers the model 5209 incorporates an internal

oscillator which may be used to drive an experiment. It is of the function-generator type, giving a sinusoidal output with good stability of amplitude and frequency and immediate settling after changes in frequency. The oscillator also generates a squarewave which, in the internal reference mode, is internally connected to the reference channel. Note that this internal squarewave shows a phase shift at higher frequencies, and, if the best phase accuracy is required, the external reference mode should be used by coupling the **OSC OUT** connector to the front-panel **AC IN** connector and using a suitable oscillator amplitude. However, in many applications the phase shift is not a problem because its effect can easily be counteracted by the use of the reference phase shifter.

The main disadvantage of this type of oscillator is its relatively high harmonic distortion of up to 0.5 percent. In most lock-in applications this is not an important matter because of the frequency-selective nature of the measurement, but, when the signal-channel filters are not in use, the distortion may lead to errors of a few tenths of one percent in amplitude measurements and phase errors of one or two tenths of a degree.

The output impedance of the oscillator is nominally 900 Ω , although on the front panel this may be marked incorrectly as 600 Ω . Note that when using the output with a typical cable and a high-impedance load, phase shifts of a few degrees may occur at higher frequencies.

The frequency of the oscillator is set from the front panel or by means of a computer command to any value between 0.5 Hz and 120 kHz. Although the setting resolution is better than 0.1 percent, the accuracy depends on component values and factory settings and is specified as ± 1 percent. On the other hand, the reference frequency meter as discussed earlier is based on a digital counter and a quartz crystal. The accuracy of this meter is better than 0.1 percent, and it can be used to monitor the frequency of the oscillator.

The internal amplitude of the oscillator is 5 V rms. This is available at the front-panel **OSC OUT** connector by the use of the computer command OA 5000, but this is not the normal method of operation. Normally the **OSC OUT** connection is taken from a two-stage attenuator consisting of a multiplying digital-to-analog converter (MDAC) followed by a switchable divide-by-ten stage. The control is by means of an integer in the range 0 to 1999 covering nominally 0 to 1999 mV rms, which can be set from the front panel or by means of the OA command.

Although this method of amplitude control is very convenient in practice, the user should bear in mind that the resolution with which the oscillator amplitude can be set depends on whether the divide-by-ten stage is in use, so that it is 1 mV for voltages below 500 mV, but 4 mV at higher levels. Also the size of the steps is not exactly uniform and in particular, there may be a slight discontinuity at the transition between 500 mV and 501 mV, where the divide-by-ten stage is switched in or out and the MDAC code changes between 500 and 50.

3.3.08 Reference Monitor

A rear-panel **TTL REF OUT** BNC connector provides a TTL waveform at the

applied reference frequency, either internal or external, and can be used to monitor correct reference channel operation.

3.3.09 Phase Shifter

The reference channel also implements the reference phase shifter, allowing the phase of the reference input to the demodulator to be adjusted to the required value. The reference phase is defined as the phase of the reference input to the demodulator with respect to a sinusoidal reference input applied to the **AC IN** socket.

This means that when the reference phase is zero and the signal input to the demodulator is a full-scale sinusoid in phase with the reference input sinusoid, the demodulator output is a full-scale positive value.

The circuits connected to the **AC IN** socket actually detect a positive-going crossing of the mean value of the applied reference voltage. Therefore when the reference input is not sinusoidal, its effective phase is the phase of a sinusoid with positive-going zero crossing at the same point in time, and accordingly the reference phase is defined with respect to this waveform. Similarly, the effective phase of a reference input to the **TTL IN** socket is that of a sinusoid with positive-going zero crossing at the same point in time.

In basic lock-in amplifier applications the purpose of the experiment is to measure the amplitude of a signal which is of fixed frequency and whose phase with respect to the reference input does not vary. This is a *scalar* measurement, for example the measurement of the response of a system to a chopped optical beam. Many other lock-in amplifier applications are of the *signed scalar* type. In these, the purpose of the experiment is to measure the amplitude and sign of a signal which is of fixed frequency and whose phase with respect to the reference input does not vary apart from reversals of phase corresponding to changes in the sign of the signal. A well known example of this situation is the case of a resistive bridge, one arm of which contains the sample to be measured. Other examples occur in derivative spectroscopy, where a small modulation is applied to the angle of the grating (in optical spectroscopy) or to the applied magnetic field (in magnetic resonance spectroscopy). Double beam spectroscopy is a further common example.

In these signed scalar measurements the phase shifter must be set, after removal of any zero errors, to maximize the demodulator output. This is the only method that will give correct operation as the output signal passes through zero, and is also the best method to be used in an unsigned scalar measurement where any significant amount of noise is present.

The reference phase shifter front-panel control uses increments of 0.1° , but increments of 5 m° are available when using the P computer command. In addition a front-panel **+90°** key allows the phase shift to be incremented in 90° steps.

The output from the phase shifter is directly connected to the reference input of the demodulator.

3.3.10 Demodulator - Introduction

The 5209, as a single-phase instrument, has a single phase sensitive detector (PSD) or demodulator.

There are various ways of implementing such elements in an analog instrument, but in the 5209 it is based on FET switches giving excellent performance at reasonable cost. In conjunction with the main signal channel filter (described earlier in section 3.3.04) it operates in either the squarewave or Walsh modes, so that the instrument has an overall response which is either squarewave or sine-wave.

3.3.11 Demodulator - Squarewave Mode

Squarewave demodulator operation is automatically selected when the main signal channel filter is set to Flat mode. When selected, the output of the reference channel is a squarewave at the fundamental frequency of the reference input voltage. The multiplying element consists of a reversing switch under the control of the squarewave generated by the reference channel. In practice the reversing switch consists of a two-way switch which causes the signal path to be connected alternately to the output of the signal channel and the output of an inverting amplifier (i.e. an amplifier with transfer function equal to -1) the input of which is connected to the output of the signal channel. Functionally, this arrangement acts as an analog multiplier which multiplies the output of the signal channel with a demodulation function consisting of a reference-derived squarewave having the two values 1 and -1. The Fourier analysis of this waveform consists of the fundamental and all odd harmonics, the amplitude of the n th harmonic being proportional to $1/n$. (Note that the fundamental is regarded as the first harmonic). It can be shown that the squarewave demodulator gives a steady-state output resulting from any Fourier component of the signal channel output which is at the fundamental frequency of the reference input voltage or any of its odd harmonics, with the response being inversely proportional to the harmonic number. Also, interfering signal voltages at frequencies close to the odd-harmonic frequencies can cause unwanted beat frequencies at the output.

3.3.12 Demodulator - Walsh Mode

The squarewave demodulator is simple to implement and (because the multiplication is performed only by switches) is capable of excellent performance at low cost. However, in the majority of experimental situations the odd-harmonic responses of the squarewave demodulator are undesirable in that they implement “windows” in the frequency domain response through which interfering voltages at or near the odd harmonics of the reference frequency can cause output errors, in the form of static offsets or of low-frequency beats. In principle, the problem could be solved by the use of a fundamental-only demodulator. In this case, the output of the reference channel is a sinusoid at the fundamental frequency of the reference input voltage. The multiplier is simply a standard analog multiplier (i.e. a multiplying element which accepts continuously variable voltages at both inputs) with one input connected to an output of the reference channel and the other to the output of the signal channel. Therefore the overall demodulator response is sinusoidal and there are no responses to reference harmonics other than the first.

In practice, there are severe problems both in implementing an analog multiplier of sufficiently good performance (in terms of frequency response, offsets and linearity) and also in constructing a reference channel to generate the required reference-derived sinusoid with sufficient purity over the frequency range required in general-purpose lock-in amplifiers. Therefore, the most common way of removing harmonic responses has been with the aid of signal-channel filters which reduce the amplitude of the offending components of the signal before they reach the demodulator.

A general-purpose lock-in amplifier is normally equipped with signal-channel filters for quite a different reason, which is to increase the dynamic range by attenuating high-level interfering signals which would otherwise force the signal-channel gain to be reduced in order to prevent overloading. The preferred Q -factor of such filters, particularly for those under microprocessor control, is not more than 2 in order to avoid excessive phase errors, but this does not give sufficient rejection of reference harmonics.

What is required is a demodulator which like the squarewave demodulator is implemented with switches, but which has better harmonic rejection. An obvious solution is to use more switches, and a set of scaling resistors, to give an overall response which is intermediate between squarewave and a sinusoidal. The required coefficients can be calculated by the application of Walsh analysis, which is the counterpart of Fourier analysis in the domain of switching functions. An 8-step Walsh synthesis of a sinusoid yields a function having zero levels of third, fifth, eleventh, thirteenth, etc., harmonic, the amplitudes of the non-zero harmonics being the same as for a squarewave.

The demodulator in the model 5209 operates in this Walsh mode whenever the main signal channel filter is set to other than the Flat setting. When the filter is set to Bandpass mode, it has a fourth order response with a Q -factor of about 2, which in conjunction with the demodulator gives essentially an overall fundamental, or sine-wave, instrument response. The greatest harmonic response is at seven times the reference frequency, where the attenuation is about 1400 (63 dB). Where harmonic response is particularly critical a further factor of 50 (34 dB) is available by switching the main filter to the Low-Pass mode.

3.3.13 PSD Monitor Output

The output of the demodulator, or phase sensitive detector, before it passes to the output low-pass filter is made available at the rear-panel **PSD MONITOR** BNC connector. This output has an impedance of 1 k Ω with a nominal first-order residual time constant of 100 μ s.

The appearance of the signal at this connector depends on the nature of the input signal, and on the filter mode, the phase setting, and selected dynamic reserve. With a full-scale sinusoid applied, the phase adjusted for maximum output, the signal channel filter set to flat mode, and the dynamic reserve set to the high stability mode, the observed signal will be a full-wave rectified sinusoid with a peak amplitude of 1 V. If the signal channel filter is turned on (i.e. set to bandpass, low-pass or notch), and the other parameters are left unchanged, the observed signal will be the product of a full-wave rectified sinusoid and the pseudo-sinusoidal Walsh function mixer drive signal.

The amplitude of this signal will be nominally 1.2 V peak. The effect of the residual time constant filtering becomes quite evident as the frequency is increased.

The signal amplitude is affected by the dynamic reserve setting and the full-scale sensitivity setting, as shown for the Flat mode is in table 3-2 below. Note that in the Walsh mode the given figures should be multiplied by 1.2.

Full-scale Sensitivity	Peak PSD Monitor Output (V) for full-scale Sinusoidal Input (Flat Mode)		
	High Stability	Normal	High Reserve
3 V	1	1	1
1 V	1	1	1
300 mV	1	1	1
100 mV	1	1	1
30 mV	1	0.1	0.1
10 mV	1	0.1	0.1
3 mV	1	0.1	0.01
1 mV	1	0.1	0.01
300 μ V	1	0.1	0.01
100 μ V	1	0.1	0.01
30 μ V	1	0.1	0.01
10 μ V	1	0.1	0.01
3 μ V	1	0.1	0.01
1 μ V	1	0.1	0.01
300 nV	1	1	0.1
100 nV	1	1	1

Table 3-2, PSD Monitor Output Amplitude for Full-Scale Sinusoidal Input when using Flat Mode

Note that noise and switching spikes will be evident at this output, particularly if the high dynamic reserve setting is selected.

3.3.14 Output Filter - Operation

The time variation of the output of the lock-in amplifier should represent the time variation of the magnitude and phase of the required input signal. The function of the output filters is to reduce the level of spurious (i.e. unwanted, non-information bearing) time variations, commonly referred to as output noise, which may be random or deterministic in nature. One inevitable source of deterministic output noise results from the shape of the signal waveform. For example, the familiar rectified sinusoid waveform with mean value of unity varies from zero to $(\pi/2)$ twice in each cycle. A second-order filter with time constant equal to the period of the sinusoid will reduce the time variation to about ± 0.02 , and a filter with three times this time constant will leave a time variation less than ± 0.002 . Where the residual fluctuation is less than 1 least significant bit of the output analog to digital converter (ADC), a noise-free input sinusoid gives rise to a noise-free digital output. However, where additive noise (random or deterministic) is present, the output time constant will normally be increased to a value which reflects a compromise between output noise and response time. Note that for rejection of deterministic noise the second-order output filter is

greatly superior to the first-order filter for equivalent response time.

If the noise process is random with an approximately flat spectrum (white noise) then the root-mean-square value of the output noise is inversely proportional to the square root of the time-constant of the output filters.

The output filter used in the model 5209 implements a first-order or second-order low-pass function, specified by the value of the time constant. For time-constant values of 3 s or less, the output filter is a conventional analog stage implemented with resistors, capacitors and operational amplifiers. It has two identical first-order low-pass sections, one of which can be switched out, allow it to be used optionally as a first-order filter or as a second-order filter with two equal time constants.

When the time constant is equal to 10 s or greater, digital filtering techniques carried out in the output processor are used in conjunction with the analog filter, but the same type of function is implemented. In this case, the analog output is obtained from a digital-to-analog converter.

The time constant of the output filter can be set to values between 1 ms and 3 ks in a 1-3-10 sequence by the front panel keys or by a computer command while the order of the filter is controlled by the **SLOPE** key. This may seem somewhat strange, and a few words of explanation may be helpful.

In traditional audio terminology, a first-order low-pass filter is described as having "a slope of 6 dB per octave" because in the high-frequency limit its gain is inversely proportional to frequency (6 dB is approximately a factor of 2 in amplitude and an octave is a factor of 2 in frequency); similarly a second-order low-pass filter is described as having "a slope of 12 dB per octave". These terms have become part of the accepted terminology relating to lock-in amplifier output filters and are used in the 5209.

Accordingly the front-panel control which selects the order of the output filter is labeled **SLOPE** and the options are **6 dB** and **12 dB**. The 6 dB/octave option is not satisfactory for most purposes because it does not give good rejection of non-random interfering signals which can cause aliasing problems with the instrument's analog-to-digital converters. However, the 6 dB/octave filter finds use where the lock-in amplifier is incorporated in a feedback control loop, and in some situations where the form of the time-domain response is critical. The user is recommended always to use 12 dB/octave unless there is some definite reason for not doing so.

3.3.15 Output Filter - Output Offset & Expand

Even when the input to the signal channel is nominally zero, the demodulator output may show a non-zero value. This phenomenon is called zero error and is usually caused by unwanted coupling or crosstalk between the signal channel and the reference channel, either in the external connections or possibly (in the most sensitive ranges and at the highest reference frequencies) within the instrument itself. Zero errors may also be caused by the effects of changing ambient temperature on the demodulator hardware although these are usually negligible in the case of modern designs such as the model 5209. The magnitudes of any zero errors are usually dependent on the

reference frequency.

The problem of crosstalk in the external circuit (i.e. the hardware which is generating the signal and the reference) is illustrated by the following numerical example. Suppose that the signal source impedance is 1 k Ω , and the reference is 1 V rms at 100 kHz. Then a stray capacitance of only 0.001 pF between the reference source and the lock-in amplifier's signal input connector would give an offset corresponding to 600 nV at the input - more than full scale on the two most sensitive ranges!

Unless they are large enough to cause overload, zero errors do not give rise to any malfunction in the demodulator, simply acting as additive errors which can be measured under zero-signal conditions and subsequently subtracted from output. Consequently, in the model 5209 the output filter includes an output offset facility allowing an offset of up to ± 150 % of full-scale to be applied to output. The offset level can be set manually or via the Auto-Offset function.

The output filter also includes an output expand facility, which allows a $\times 10$ expansion to be applied to it, thereby increasing the maximum full-scale sensitivity to 10 nV.

3.3.16 Dynamic Reserve and Output Stability

The 5209 lock-in amplifier includes gain in three main areas, these being the signal channel ahead of the filters, between the filters and the demodulator, and in the output channel. The first two can be AC coupled, but the output stages have to be DC coupled. DC coupled amplifiers potentially exhibit DC drift with time and temperature, the effect of which increases as the gain increases. Hence it might at first sight appear that it would be best to use high values of AC gain and minimal DC gain. However, if this were done then the instrument would have very low *dynamic reserve*.

The dynamic reserve of a lock-in amplifier is defined as the ratio by which input noise voltages may exceed the full-scale sensitivity value without causing overload. It is usually expressed in decibels:

$$\text{DR(in dB)} = 20 \times \log(\text{DR(as a ratio)})$$

Note that a noise voltage may be random or may be periodic at some fixed frequency; in the latter case it is often referred to as an interfering signal.

Obviously the dynamic reserve value is limited by the full-scale sensitivity setting: for example, a lock-in amplifier could well show a reserve value of 1000 (60 dB) at a full-scale sensitivity setting of 1 mV (implying the capability of handling 1 V noise) but would not be able to maintain this value of reserve at a full-scale sensitivity setting of 1 V because this would require the capability of handling 1000 V noise.

There are two mechanisms by which dynamic reserve is achieved, demodulator reserve and filter reserve, discussed in the following paragraphs.

Demodulator Reserve

The demodulator reserve is affected by the total signal channel (AC) gain. If this is

high, then the demodulator will overload at lower levels of interfering signal than would be the case with lower gains. Consequently the dynamic reserve will be lower. Hence the maximum reserve is achieved at low levels of signal channel gain.

However at high sensitivity settings, lower values of AC gain require that higher values of DC gain are used to maintain the overall gain. Consequently the instrument exhibits poorer output stability with time and temperature.

Filter Reserve

One of the functions of the signal-channel filters is to provide dynamic reserve by reducing the amplitude of interfering signals. (The other function is to reject reference harmonics as discussed in sections 3.3.04 and 3.3.12). The success of this operation depends on the frequency of the interfering signal being well outside the pass-band of the filter. This is very often the case, because the pass-band occupies only a tiny fraction of the total frequency range; however, when a serious interfering signal does occur in the pass-band, it is sometimes possible to change the frequency of the measurement, for example, by changing the chopper speed in the case of an optical measurement. Note that the action of the filter does not improve the dynamic reserve unless there is amplification in the signal channel following the filter. If such gain is not present, an interfering signal of peak value equal to the overload level at the input of the filter would not cause overload whether attenuated by the filter or not. It follows from these considerations that the greatest improvement in the reserve that the filter can provide is equal to the value of the voltage gain in the signal channel following the signal-channel filter. This value is called the filter reserve.

In many experimental situations where the signal-channel filter is used for reserve improvement, the amount of available filter reserve is not the limiting factor.

In practice, tunable second-order active filters show substantially higher levels of random noise than simple amplifying stages, and if this is to be made insignificant compared with the preamplifier noise then there must be sufficient voltage gain in the signal channel in front of the filter.

Therefore the distribution of the total instrument gain involves two tradeoffs:

- 1) In the signal channel (AC) gain, gain in front of the filter improves the noise while gain after the filter improves the filter reserve.
- 2) Increasing the signal channel (AC) gain and reducing the output (DC) gain improves the output stability but decreases the dynamic reserve.

The model 5209 allows the user to control the distribution of these gains via the dynamic reserve control, which has three settings: high reserve, normal and high stability. The dynamic reserve and output stability available at each setting is shown in table 3-3

Setting	Dynamic Reserve		Stability
	Filter On	Filter Off	
High Reserve	up to 130 dB	60 dB	500 ppm/°C
Normal	up to 110 dB	40 dB	50 ppm/°C
High Stability	up to 90 dB	20 dB	5 ppm/°C

Table 3-3, Dynamic Reserve and Output Stability

The high reserve setting may cause increased demodulator noise and signal-channel noise, and reduced output stability. In most typical measurement situations a dynamic reserve of 20 dB is adequate and the use of the high stability setting is recommended. The normal setting, giving 40 dB demodulator reserve for full-scale sensitivity 10 mV and below, will handle very high noise levels (noise voltage 100 times the signal voltage), so that the high reserve mode should be used only in exceptional cases.

At lower values of full-scale sensitivity the instrument provides substantial filter reserve even in the high stability setting and the first choice for normal experimental situations should be high stability in conjunction with the bandpass or low-pass filter

3.3.17 Main Analog to Digital Converter

The main analog to digital converter (ADC) in the 5209 converts the analog signals from the output filter and at the rear-panel **ADC AUX INPUTS** to allow them to be displayed on the front-panel **OUTPUT** LCD and read via the computer interfaces. In addition, the digitized signals can also be subjected to further processing by the output processor, as is required for example for ratio calculations and for noise measurements.

The ADC can be triggered in a number of ways, as follows:-

Reference Synchronous Trigger

In this setting, the ADC is triggered synchronously with the reference frequency. The maximum conversion rate is nominally once every 5 ms (200 Hz), so that at low reference frequencies there will be one trigger per reference period. At higher reference frequencies there will be one trigger per some multiple of the reference period. Each trigger results in the conversion of the output and one of the four **ADC AUX INPUTS**. Thus any given **ADC AUX INPUT** is converted once every four trigger cycles.

External Trigger Mode

In this setting the ADC is triggered once on each positive going TTL transition detected at rear-panel **ADC EXT TRIG IN** connector. If an applied trigger occurs before the converter has finished processing the previous trigger, it is ignored. On any given trigger, the output and all four of the **ADC AUX INPUTS** are converted.

Asynchronous Trigger Mode

In this setting the ADC is triggered asynchronously at 100 Hz. On any given trigger, the output and one of the four **ADC AUX INPUTS** are converted. Thus any given **ADC AUX INPUT** is converted once every four trigger cycles (i.e. at a

25 Hz rate).

Ratio Trigger Mode

In this setting, triggering is the same as for the Reference Synchronous mode, but only the output and the **ADC AUX INPUT CH1** are converted. The maximum conversion rate is nominally once every 5 ms (200 Hz), so that at low reference frequencies there will be one trigger per reference period. At higher reference frequencies there will be one trigger per some multiple of the reference period.

The advantage of this mode over the reference synchronous trigger mode is that the **ADC AUX INPUT CH1** input is converted at the same rate as the output, giving better results when the instrument is set to the ratio display mode.

NOTE: In the ratio trigger mode, the ADC AUX INPUT CH2, CH3 and CH4 inputs are never converted.

“8F” Trigger Mode

In this setting, at reference frequencies below 20 Hz, triggering is synchronous with the reference, but there are eight triggers per reference signal period. On any given trigger, the output and one of the four **ADC AUX INPUTS** are converted. Thus any given **ADC AUX INPUT** is converted once every four trigger cycles (i.e. twice per reference cycle). The eight output readings are digitally averaged and it is the averaged value that is displayed and made available for transfer to a computer.

At frequencies above 20 Hz, the trigger mode automatically changes to the asynchronous trigger mode, but 8F triggering is automatically restored if the frequency subsequently drops to less than 20 Hz.

3.3.18 Output Processor - General

Although shown on the block diagram as a separate entity, the output processor is in fact part of the instrument's main microprocessor. It provides more digital filtering of the output signal if this is needed in addition to that already performed by the main analog output filters, as well as calculating the noise and the ratio or logarithm of the ratio of the output to a voltage applied to the rear-panel **ADC AUX INPUT CH1** connector.

3.3.19 Output Processor - Noise Measurements

The noise measurement facility uses the output processor to calculate the rectified output noise as a percentage of the present full scale sensitivity setting. The noise processor is a simple, broadband, full-wave rectifier with an output smoothing time constant of 10.24 s. It is AC coupled, with a coupling time constant also of 10.24 s, to the X-channel output.

The calibration is the same as the calibration in the **% FS** mode, i.e., the output reading is the same as would be obtained by averaging the magnitude of the output display reading, apart from the effect of the AC coupling.

Considering any sinusoidal component of the noise, the response of the lock-in amplifier is 3 dB less (in rms terms) than the response to an in-phase signal. This is the "phase-sensitive advantage" and has traditionally been expressed by the statement that the so-called equivalent noise bandwidth is $1/4TC$ for 6 dB/octave and $1/8TC$ for 12 dB/octave (where TC is the time-constant, in seconds), although the actual spectral bandwidth is double this.

The purpose of the AC coupling is to allow noise measurements to be made in the presence of a steady signal. If the signal varies significantly over a 10 second timescale, it will contribute to the measured noise. It is intended that noise measurements should normally be made with a time constant much less than 10 s.

The AC coupling will cut off the lowest-frequency noise components, with a lower cutoff frequency of 0.0155 Hz. This has the effect of reducing the equivalent noise bandwidth (ENBW) below the usually quoted values of $1/(4TC)$ Hz for 6 dB/octave and $1/(8TC)$ for 12 dB/octave. The corrected values are given in table 3-4.

TC (seconds)	Equivalent Noise Bandwidth (Hz)	
	6 dB/oct	12 dB/oct
3.0	0.06445	0.02492
1.0	0.2278	0.1037
0.3	0.8096	0.3933
0.1	2.476	1.226
0.03	8.309	4.142
0.01	24.08	10.40
0.003	83.31	41.64
0.001	250.0	125.0

Table 3-4, ENBW of 5209 in Noise Measurement Mode

Note that these values are half of those that would be obtained with sinusoidal measurements over a range of noise frequencies close to the reference frequency. The formula for the noise bandwidth, NBW , is:

$$NBW = \frac{\left(\int (\text{gain}^2 \cdot df) \right)}{(\text{gain at center frequency})^2}$$

If, as is usually the case, the amplitude distribution of the noise being measured is Gaussian rather than sinusoidal, then a correction factor needs to be applied to the displayed reading. This is the ratio (Gaussian rms-to-mean ratio)/(sinusoidal rms-to-mean ratio):

$$= \frac{\sqrt{\frac{\pi}{2}}}{\left(\frac{\pi}{2 \times \sqrt{2}} \right)}$$

$$= 1.1284$$

This correction factor is applicable to the "flat" main signal channel filter setting where the multiplying function is a square wave. If the filter is in the low-pass or band-pass mode, an additional factor must be taken into account. The filter has a Q -factor of 2 and thus its bandwidth introduces only a negligible reduction in the equivalent noise bandwidth of the measurement. However, these filter modes switch in the "Walsh Function" demodulator and this does affect the noise measurement. The stepped approximation to a sinewave response of this demodulator adds the additional factor:

$$\sqrt{\frac{2}{\left(\frac{1}{2^2} + \left(\frac{1}{2} + \frac{1}{\sqrt{2}}\right)^2\right)}} \\ = 1.0824$$

This factor when combined with the correction for Gaussian noise amplitude distributions yields an overall correction for the low pass or bandpass modes of:

$$1.1284 \times 1.0824 = 1.2214$$

Hence, for example, if the instrument is being used in the noise measurement mode, the full-scale sensitivity is 100 nV, the **OUTPUT** LCD shows a reading of 80%, and the input noise amplitude distribution is Gaussian then the true noise level is $80\% \times 100 \text{ nV} \times 1.2214$, or 97.71 nV. To obtain the noise spectral density, simply divide this figure by the square root of the equivalent noise bandwidth corresponding to the present time-constant and slope setting, as given in table 3-3.

The user is strongly advised to use an oscilloscope attached to the **SIG MON** (signal monitor) output when making noise measurements as this is the best way of ensuring that one is measuring a random process rather than line pick-up or other non-random signals.

3.3.20 Analog Panel Meter

The front-panel analog meter is normally driven by the output of the output filter. However at low reference frequencies and short time-constants the meter needle will oscillate as it attempts to track the analog signal.

Under these conditions, the digital outputs as read from the front panel or by a computer command can be averaged in the output processor using the 8F trigger mode (discussed in section 3.3.17) to give a stable reading. The instrument is therefore fitted with a *digimeter* mode which when turned on allows the analog meter to be driven by an analog representation of the signal displayed on the digital meter, rather than directly by the output filter.

Note that the digimeter mode always defaults to the off state on power-up.

3.3.21 OUT Analog Output

The front-panel **OUT** connector gives an analog voltage proportional to the instrument output, depending on the display mode set in the **OUTPUT** section.

When set to the **% FS** or **SIGNAL** display modes, **OUT** gives an analog voltage proportional to the output. With time-constant values below 10 s, this is obtained directly from the output filter, but at higher values, it is generated from the output processor via a digital-to-analog converter. The full-scale voltage is ± 10.000 V although the output remains valid up to ± 15.000 V

When set to the **NOISE**, **RATIO** or **LOG R** mode, the voltage at the **OUT** connector depends on the mode selected, and is generally derived from the output processor via a digital-to-analog converter.

3.3.22 Auxiliary Analog Inputs and Outputs (ADCs and DACs)

The model 5209 incorporates four auxiliary ADC inputs, which are digitized by a conventional sampled converter giving a resolution of 1 mV in ± 15.000 V. These inputs can be used for digitizing slowly changing or DC signals which are associated with an experiment, such as those generated by temperature and pressure transducers, so that they can be incorporated in ratio calculations or transferred to a controlling computer. The sample rate depends on the ADC trigger mode, as discussed already in section 3.3.17

Two auxiliary DAC analog outputs are also provided which offer the same resolution as the ADCs, namely 1 mV in ± 15.000 V.

3.3.23 Overload Detection

There are three overload detectors in the signal channel, at the following locations in the circuit:

1. before the line frequency rejection filter;
2. before the main signal-channel filter;
3. at the output of the main signal-channel filter, i.e. the same point as accessed by the **SIG MON** connector.

The outputs of these detectors are connected to the left-hand **OVL** indicator in the **SENSITIVITY** section indicators and controls, and when this lights the unit is in input overload. Such overloads are removed by increasing the full-scale sensitivity value, by increasing the value of the dynamic reserve mode selection, or by introducing one or more of the signal-channel filters.

There is a further overload detector following the demodulator, located at the input to the analog-to-digital converter. The output of this detector is connected to the right-hand **OVL** indicator in the **OUTPUT** section, and when this lights the unit is in output overload. If overload occurs at this point with less than 150 percent full-scale showing at the output, the overload can be removed by increasing the time constant of the output filter; by increasing the value of the dynamic reserve or by making use of

the signal-channel filters.

Input and output overload conditions cause the assertion of bit 4 in the status byte, and one or more of bits 3, 4, 5 and 6 in the overload status byte. Hence a controlling computer program can determine the location of the overload and make the required adjustments to remove it.

3.3.24 Main Microprocessor - General

All functions of the instrument are under the control of a microprocessor which in addition drives the front panel displays, processes front panel key operations and supports the RS232 and GPIB (IEEE-488) computer interfaces.

3.3.25 Main Microprocessor - Auto Functions

The microprocessor also controls the instrument's auto-functions, which are control operations executed by means of a single command or two key-presses. These functions allow easier, faster operation in most applications, although direct manual operation or special purpose control programs may give better results in certain circumstances. During application of several of the auto-functions, decisions are made on the basis of output readings made at a particular moment. Where this is the case, it is important for the output time constant set by the user to be long enough to reduce the output noise to a sufficiently low level so that valid decisions can be made and that sufficient time is allowed for the output to settle.

The following sections contain brief descriptions of the auto-functions. Note that unlike the auto-functions built into some instruments the functions in the 5209 operate once only each time they are selected, rather than remaining active. Hence, for example, the auto-sensitivity function does not cause the instrument to continuously adjust its full-scale sensitivity as the input signal level changes, but rather makes one adjustment which will attempt to match the signal level at the time the function is called.

Auto-Sensitivity

The auto-sensitivity function causes the sensitivity to be automatically set to the sensitivity range that yields an output between 30% and 100% of full scale. Note that the auto-sensitivity function does not depend on the phase setting to work correctly. However, the phase will have to be set correctly to maximize the output reading.

In the presence of noise, or a time-varying input signal, it may be a long time before the Auto-Sensitivity sequence comes to an end, and the resulting setting may not be what is really required.

Auto-Phase

In an Auto-Phase operation the value of the signal phase is computed and an appropriate phase shift is then introduced into the reference channel so as to bring the value of the signal phase to zero. The intended result is to maximize the output.

Any small residual phase can normally be removed by calling Auto-Phase for a second time after a suitable delay to allow the output to settle.

The Auto-Phase facility is normally used with a clean signal which is known to be of stable phase. It usually gives very good results provided that output is steady when the procedure is called.

If a zero error is present on the output, such as may be caused by unwanted coupling between the reference and signal channel inputs, then the following procedure should be adopted:-

- 1) Remove the source of input signal, without disturbing any of the connections to the signal input which might be picking up interfering signals from the reference channel. In an optical experiment, for example, this could be done by shielding the detector from the source of chopped light.
- 2) Execute an Auto-Offset operation, which will reduce the output to zero.
- 3) Re-establish the source of input signal. The output will now indicate the true level of input signal, *at the present reference phase setting*.
- 4) Execute an Auto-Phase operation. This will set the reference phase shifter to the phase angle of the input signal. However, because the offset level which was applied in step 2 was calculated at the original reference phase setting, it will not now be correct.
- 5) Remove the source of input signal again.
- 6) Execute a second Auto-Offset operation, which will reduce the output to zero at the new reference phase setting.
- 7) Re-establish the source of input signal.

This technique, although apparently complex, is the only way of removing the effect of crosstalk which is not generally in the same phase as the required signal.

Auto-Offset

In an Auto-Offset operation the offset functions is turned on and is automatically set to the value required to give a zero output. Any small residual value can normally be removed by calling Auto-Offset for a second time after a suitable delay to allow the output to settle.

The primary use of the Auto-Offset is to cancel out zero errors which are usually caused by unwanted coupling or crosstalk between the signal channel and the reference channel, either in the external connections or possibly under some conditions in the instrument itself. Note that if a zero error is present, the Auto-Offset function should be executed before any execution of Auto-Phase.

Auto-Measure

The auto-measure function causes the following actions to occur:-

- 1) The signal channel filter is set to bandpass mode, and tuned to the reference frequency.

- 2) The display is set to % FS
- 3) Output offset is turned off.
- 4) Normal dynamic reserve is selected.
- 5) The time constant is set to 300 ms or 3 s (depending on the reference frequency) and the slope to 12dB/octave.
- 6) An auto-sensitivity function is performed.
- 7) An auto-phase operation is performed.
- 8) The time constant is returned to the setting in effect before the auto-measure function was called.

The Auto-Measure function is intended to give a quick setting of the instrument which will be approximately correct in typical simple measurement situations. For optimum results in any given situation, it may be convenient to start with Auto-Measure and to make subsequent modifications to the settings of individual controls.

Auto-Normalize

The auto-normalize function adjusts the sensitivity vernier as required to obtain 100% of full-scale output. A normalize operation always begins with an auto-sensitivity cycle. If none of the sensitivity ranges yield an output magnitude between 30% and 110% of full scale, the sensitivity is set to one extreme or the other, normalization is not attempted and the function terminates.

Auto Tune

If the manual filter tuning mode is active, pressing the auto-tune operation sets the filter frequency to the reference frequency (in 2F mode to twice the reference frequency). If the tracking filter tuning mode is in effect then auto-tune has no effect.

This completes the description of the main functional blocks of the instrument.

3.4 General

3.4.01 Accuracy

When the demodulator is operating under correct conditions, the absolute gain accuracy of the instrument is limited by the analog components in the signal channel and output channels, and the absolute phase accuracy is limited by the analog components in both the signal and output channels and in the reference channel. The resulting typical accuracy in flat mode is ± 1 percent of the full-scale sensitivity and ± 1 degree.

3.4.02 Power-up Defaults

All instrument settings are retained when the unit is switched off. When the instrument is switched on again the settings are restored but with the following exceptions:-

- a) The GPIB mask byte is set to zero.
- b) The REMOTE parameter is set to zero (front panel controls are enabled).
- c) The front-panel lights are turned on.
- d) Digimeter mode is turned off.

4.1 Front Panel

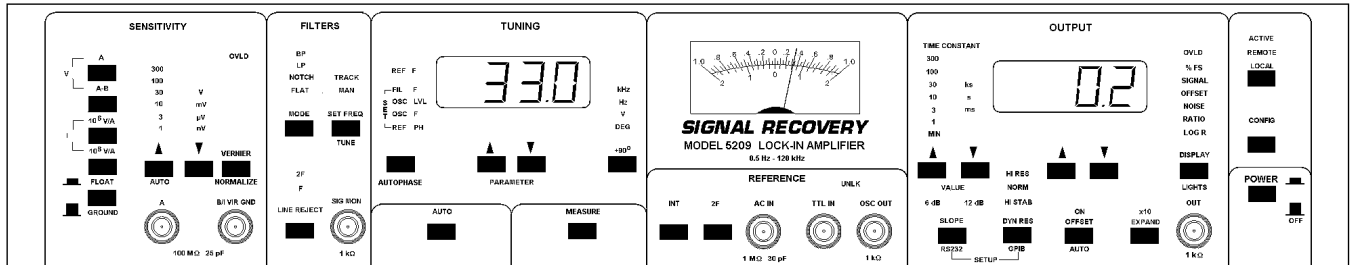

Figure 4-1, Model 5209 Front Panel Layout

The front panel of the Model 5209 follows a logical layout, with controls and displays associated with the input on the left-hand side and those with the output on the right-hand side. As shown in figure 4-1 above, the controls, displays and connectors are organized for convenience into six labeled groups, with additional areas for the analog panel meter, power switch and two other controls.

4.1.01 Connectors

There are seven BNC connectors mounted on the front panel, used for the most common connections to and from the user’s experiment. Their purpose is described in the following paragraphs. Connectors used less frequently are mounted on the rear-panel and are described in section 4.2

A and B/I VIR GND BNC connectors

The **A** connector is the signal input connector for use in single-ended and differential voltage mode. The **B/I VIR GND** connector is the signal input connector for use in differential voltage mode (A-B). It is also the signal input connector when current input mode is selected.

SIG MON BNC connector

The signal at this connector is that at the output of the signal channel, immediately prior to the phase sensitive detectors. The gain between the **A** or **A-B** input connectors and this connector depends on the full-scale sensitivity range, on the main signal channel filter setting and on the setting of the dynamic reserve control with the nominal values being given in table 4-1.

Full-scale Sensitivity	Gain at Dynamic Reserve Setting		
	High Stability	Normal	High Reserve
3 V	0.3332	0.3332	0.3332
1 V	1	1	1
300 mV	3.332	3.332	3.332
100 mV	10	10	10
30 mV	33.32	3.332	3.332
10 mV	100	10	10
3 mV	333.2	33.32	3.332
1 mV	1000	100	10
300 μ V	3332	333.2	33.32
100 μ V	10000	1000	100.0
30 μ V	33320	3332	333.2
10 μ V	100000	10000	1000
3 μ V	333200	33320	3332
1 μ V	1000000	100000	10000
300 nV	333200	333200	33320
100 nV	1000000	1000000	100000

Table 4-1, Signal Channel Gain, Nominal, A or A-B Input to Sig Mon Output (Bandpass, Low-Pass or Notch Filter Modes)

When the main signal channel filter is inactive, i.e. set to flat, the given figures should be multiplied by 0.790

The signal monitor output is unbuffered, and has an output impedance of 1 k Ω . Internal noise and switching spikes may be present. The higher the reserve setting, the greater their amplitude will be relative to that of the signal.

AC IN connector

This is the input connector for a general purpose external reference signal. The instrument is fitted with two reference input connectors for external reference mode operation, **TTL IN** and **AC IN**. Wherever possible, use the TTL input, particularly if the reference signal is asymmetrical. If the available reference is not suitable for driving a TTL input, then use the **AC IN** reference input.

The input impedance at this connector is 1 M Ω in parallel with 30 pF.

TTL IN connector

This connector is provided to allow TTL compatible pulses to be used as the reference input when operating in external reference mode. Wherever possible, it should be used in preference to the **AC IN** connector.

NOTE: Do not apply a reference to both the AC IN and TTL IN connectors simultaneously, since this will result in incorrect operation of the reference channel.

OSC OUT connector

This is the output connector for the internal oscillator, which may be set to generate a sine wave between 0.5 Hz and 120 kHz with amplitude between 1 mV and

1.999 V rms, or 5.000 V rms.

NOTE: *Although the output impedance at this connector may be shown on the front panel as 600 Ω , it is in fact nominally 900 Ω*

OUT connector

The signal at this connector is an analog voltage representing the instrument's output, with the actual output depending on the setting of the **OUTPUT** section **DISPLAY/LIGHTS** control.

The output impedance at this connector is 1 k Ω .

4.1.02 Keys

The instrument is fitted with thirty-one keys of four different types, as follows:-

Voltage/Current mode Input Keys

The upper four keys at the extreme left-hand side of the front-panel are used to select the input mode and are mechanically interlocked, such that pressing one of them results in the release of another. At least one of these keys should always be depressed.

On/Off keys

Some keys, such as the **POWER** switch and the **CONFIG** key have an alternate On-Off operation each time they are pressed. The present state of the key is indicated either by the fact that the position of the key relative to the panel differs for each state, or by an adjacent indicator being lit or unlit.

Selection keys

Controls with several possible settings, such as the signal channel filter **MODE** control, change setting each time the corresponding key is pressed. Hence, for example, to change the filter from flat to bandpass mode, press the filter **MODE** key three times; to change it back to flat mode, press it once more.

▲ and ▼ keys

There are four pairs of ▲ and ▼ keys that are used to adjust those controls, such as input sensitivity or internal oscillator frequency, which need to be changed over a wide range of values.

The ▲ and ▼ keys corresponding to the input sensitivity and output time constant controls are used to set these to the required values simply by repeatedly pressing the relevant key until the required setting is illuminated; press the ▲ key once to decrease the sensitivity, or increase the time constant, by one step, and press the ▼ key once to increase the sensitivity, or decrease the time constant, by one step.

The ▲ and ▼ keys immediately under the **TUNING** LCD adjust the internal oscillator frequency and amplitude, the signal channel filter frequency and the reference phase. Each control is changed by first using the **TUNING** mode key to choose the required control, at which point the LCD will show the present setting of the control. Then, use the ▲ and ▼ keys to change the setting. Note that the keys are

fitted with an acceleration function, such that if they are pressed and released quickly, the setting will change by one in the least significant digit, but if pressed and held then the setting will change approximately ten times faster. This makes it very easy and fast to change the setting of a control over a wide range of values.

Finally, the ▲ and ▼ keys immediately under the **OUTPUT** LCD adjust the output offset level. First use the **OUTPUT** section **DISPLAY/LIGHTS** key to select **OFFSET**, at which point the LCD displays the present offset setting. Then use the ▲ and ▼ keys to change the value as required.

Dual Key Functions

Some operations, such as the auto-functions, require that two keys be pressed in succession. For example, in order to perform an auto-sensitivity operation, first press the red **AUTO** key. Then press the ▲ key in the **SENSITIVITY** section which has the secondary **AUTO** (auto-sensitivity) function.

4.1.03 Control Setting Indicators

The present setting of the various instrument controls is shown by the relevant legend being lit. The setting of controls, such as input sensitivity, which require both a value and a unit, are indicated by illuminating two legends, one for the value and one for the unit.

4.1.04 Overload Indicators

There are two front-panel red overload indicators which show **OVLD** under overload conditions. The first, in the top right-hand corner of the **SENSITIVITY** section, indicates an input overload, and the second, in the top right hand corner of the **TUNING** section, indicates an output overload.

4.1.05 LCD Displays

The instrument is fitted with two, 3½ digit, LCD displays. The left-hand one, **TUNING**, is used to adjust four controls (Signal channel filter frequency, internal oscillator amplitude and frequency, and reference phase) and to display the present reference frequency.

The right-hand LCD, **OUTPUT**, is used to adjust the output offset control and to display the instrument's outputs.

4.1.06 Analog Panel Meter

The analog panel meter in the center of the instrument always displays the same output that appears on the **OUTPUT** LCD.

4.2 Rear Panel

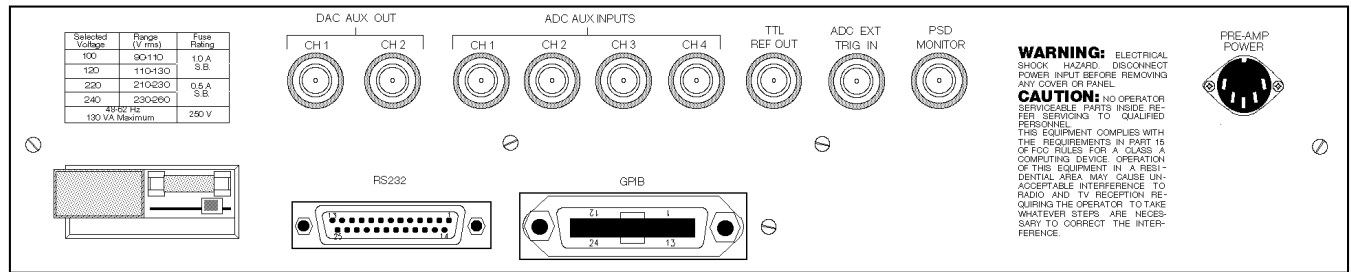

Figure 4-2, Model 5209 Rear Panel Layout

As shown in figure 4-2, the line power input assembly, RS232 and GPIB (IEEE-488) connectors, preamplifier power connector and nine BNC signal connectors are mounted on the rear panel of the instrument. Brief descriptions of these are given in the following sections.

4.2.01 Line Power Input Assembly

This houses the line voltage selector and line input fuse. To check, and if necessary change, the fuse or line voltage see the procedure in section 2.1.05.

4.2.02 RS232 Connector

This 25-pin D type RS232 interface connector implements pins 1, 2, 3, 4, 5 and 7 (Earth Ground, Transmit Data, Receive Data, Request to Send, Clear to Send and Logic Ground) of a standard DTE interface. To make a connection to a PC-compatible computer, it is normally sufficient to use a three-wire cable connecting Transmit Data to Receive Data, Receive Data to Transmit Data, and Logic Ground to Logic Ground. Appendix D shows the connection diagrams of cables suitable for computers with 9-pin and 25-pin serial connectors. Pinouts for this connector are given in appendix B.

4.2.03 GPIB Connector

The GPIB interface connector conforms to the IEEE-488.1 1978 Instrument Bus Standard. The standard defines all voltage and current levels, connector specifications, timing and handshake requirements.

4.2.04 PREAMP POWER Connector

This connector supplies ± 15 V DC at up to 100 mA and can be used for powering any of several optional remote preamplifiers available from **SIGNAL RECOVERY**. Pinouts for this connector are given in appendix B.

4.2.05 DAC AUX OUT CH1 and CH2 Connectors

These are the output connectors for the instrument's auxiliary digital to analog converters. The voltage at these connectors can be set either from the front panel or by the use of remote computer commands in the range ± 15.0 V to a resolution of 1 mV.

The outputs are of low impedance.

4.2.06 ADC AUX INPUTS CH1 - CH4 Connectors

The input voltages at these connectors may be digitized using the auxiliary ADCs and read by the use of a computer command. The input voltages are sampled and held when the ADC is triggered, and several different trigger modes are available. These modes can be set either from the front panel or by using a remote computer command. The input voltage range is ± 15.0 V and the resolution is 1 mV.

The voltage at the **CH1** input is used as the denominator for the ratio and log-ratio calculations when either of these outputs are selected.

4.2.07 TTL REF OUT Connector

The signal at this connector is a TTL-compatible waveform synchronous with the reference. This output monitors correct reference channel operation but its polarity is not uniquely defined so that it does not necessarily show the correct phase relationship with the front-panel **SIG MON** output.

4.2.08 ADC EXT TRIG IN Connector

This connector accepts a TTL-compatible input and can be used for triggering the auxiliary Analog to Digital Converters (ADCs). The input operates on the positive edge only.

4.2.09 PSD MONITOR Connector

The output of the phase sensitive detector before the output filter is provided at this connector and has an impedance of 1 k Ω . The nominal time constant at this output is 100 μ s with a first order roll-off and the output is inverted with respect to the main output.

The appearance of the signal depends on the nature of the input signal, and on the filter mode, the phase setting, and selected dynamic reserve. With a full-scale sinusoid applied, the phase adjusted for maximum output, the signal channel filter set to flat mode, and the dynamic reserve set to high stability, the observed signal will be a full-wave rectified sinusoid with a peak amplitude of 1 V. If the signal channel filter is turned on (i.e. set to bandpass, low-pass or notch), and the other parameters are left unchanged, the observed signal will be the product of a full-wave rectified sinusoid and the pseudo-sinusoidal Walsh function mixer drive signal. The amplitude of this signal will be nominally 1.2 V peak. The effect of the residual time constant filtering becomes quite evident as the frequency is increased.

The signal amplitude is affected by the dynamic reserve setting and the full-scale sensitivity setting, as shown for the Flat mode is in table 4-2 below. Note that in the Walsh mode the given figures should be multiplied by 1.2.

Full-scale Sensitivity	Peak PSD Monitor Output (V) for full-scale Sinusoidal Input (Flat Mode)		
	High Stability	Normal	High Reserve
3 V	1	1	1
1 V	1	1	1
300 mV	1	1	1
100 mV	1	1	1
30 mV	1	0.1	0.1
10 mV	1	0.1	0.1
3 mV	1	0.1	0.01
1 mV	1	0.1	0.01
300 μ V	1	0.1	0.01
100 μ V	1	0.1	0.01
30 μ V	1	0.1	0.01
10 μ V	1	0.1	0.01
3 μ V	1	0.1	0.01
1 μ V	1	0.1	0.01
300 nV	1	1	0.1
100 nV	1	1	1

Table 4-2, PSD Monitor Output Amplitude for Full-Scale Sinusoidal Input when using Flat Mode

Note that noise and switching spikes will be evident at this output, particularly if the high dynamic reserve setting is selected.

5.1 Introduction

This chapter describes how to operate the model 5209 using the front panel controls, and discusses its capabilities when used in this way. Chapter 6 provides similar information in the situation where the unit is operated remotely using one of the computer interfaces.

The model 5209 uses a combination of keys and LED indicators on its front panel to set the various instrument controls, allowing the operator to determine the instrument's status at a glance. Controls, associated indicators, displays and connectors are grouped for operator convenience into clearly delineated areas. There are five such labeled areas: **SENSITIVITY**, **FILTERS**, **TUNING**, **REFERENCE** and **OUTPUT**, as well as the analog panel meter, power switch, and, in the upper right-hand corner, the **LOCAL** and **CONFIG** keys.

Specific information regarding each functional grouping is provided in the following sections.

5.2 SENSITIVITY Group

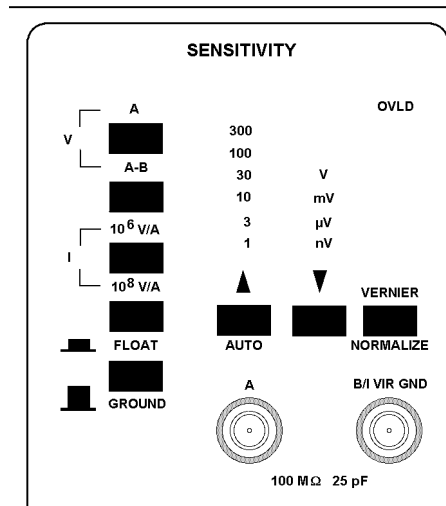

Figure 5-1, SENSITIVITY Group

As shown in figure 5-1, the **SENSITIVITY** group contains the two input connectors, several keys and an overload indicator. Information about each follows.

5.2.01 A and B/I VIR GND BNC Connectors

The function of these input connectors depends on whether the 5209's input is operating in the voltage-sensitive or current-sensitive mode, as set by the upper four right-hand interlocking keys. Pressing either **A** or **A-B** results in a voltage-sensitive input. Pressing **10⁶ V/A** or **10⁸ V/A** gives a current sensitive input.

5.2.02 A Key

When this key is depressed, the input is in single ended voltage mode, and the signal to be measured should be connected to the BNC connector marked **A**.

5.2.03 A-B Key

When this key is depressed, the input is in differential voltage mode, and the differential voltage to be measured should be connected to the BNC connectors marked **A** and **B/I VIR GND**.

5.2.04 10^6 V/A and 10^8 V/A Keys

When either of these keys are depressed, the input is in current sensitive mode and the signal to be measured should be connected to the virtual-ground BNC connector marked **B/I VIR GND**. When 10^6 V/A is selected, an applied current of 10^{-6} A will give 1 V at the input of the voltage preamplifier. When 10^8 V/A is selected, an applied current of 10^{-8} A gives 1 V at the input of the voltage preamplifier. The preamplifier's sensitivity in turn is set by the full-scale sensitivity control. Thus the overall sensitivity in current measurements is influenced by both the selected current conversion gain (10^6 V/A or 10^8 V/A) and the selected full-scale voltage sensitivity. The phasing at the **B/I VIR GND** connector in current measurement operation is the same as that at the **A** connector in voltage measurement operation.

5.2.05 FLOAT/GROUND Key

When this key is depressed, the shells of both input connectors are returned to chassis ground through a 1 k Ω resistor for improved ground-loop interference rejection. When released, the shells of the input connectors are returned directly to chassis ground.

5.2.06 SENSITIVITY \blacktriangle and \blacktriangledown Keys

The principal function of the **SENSITIVITY** \blacktriangle and \blacktriangledown keys is to set the instrument's full-scale sensitivity to values in the range 100 nV to 3 V rms in a 1-3-10 sequence. The present setting is shown by the relevant figure and units indicators being lit.

The \blacktriangle key also has a secondary auto-function, as indicated by the label beneath it. The secondary function is accessed when the red **AUTO** key is pressed prior to pressing the arrow key.

Auto-Sensitivity

The secondary function of the **SENSITIVITY** \blacktriangle key is to initiate an auto-sensitivity operation. If the red **AUTO** key (located beneath the **TUNING** group) has been pressed, pressing the **SENSITIVITY** \blacktriangle key will cause the sensitivity to be automatically set to the sensitivity range that yields an output between 30% and 100% of full scale. Note that the auto-sensitivity function does not depend on the phase setting to work correctly. However, the phase will have to be set correctly to maximize the output reading.

5.2.07 VERNIER/NORMALIZE Key

This primary function of this key is to turn the vernier sensitivity control on and off, although it has a secondary function when it used to initiate an auto-normalize operation.

In normal use the full-scale sensitivity of the instrument is set to a value in a 1-3-10 sequence between 100 nV and 3 V, and only one associated indicator will be lit to indicate the present setting. Hence, for example if the instrument were measuring a 200 mV sinusoidal signal, the sensitivity were adjusted to 300 mV and the other controls including the reference phase were correctly set, then the displayed output would be 66.7%.

The vernier function allows the full-scale sensitivity to be set to an intermediate value between the preset ranges, and is indicated by two adjacent range indicators being lit. In the example above, if the 300 mV is the range in effect when vernier mode is selected, both the 300 mV and the 100 mV sensitivity indicators light. The full-scale sensitivity will be a value somewhere in the range of 300 mV and 100 mV and can be adjusted using the sensitivity ▲ and ▼ keys. Note that in this mode there is no means of identifying what the actual full-scale sensitivity is.

To re-establish calibrated full-scale sensitivity operation, simply press the vernier key again.

Pressing the red **AUTO** key and then the **VERNIER/NORMALIZE** key initiates an auto-normalize operation. This causes the vernier mode to be activated and then the sensitivity is adjusted to achieve an output of 100% (full-scale).

The auto-normalize operation always begins with an auto-sensitivity function. If none of the sensitivity ranges yields an output magnitude between 30% and 110% of full scale, the sensitivity is set to one extreme or the other and normalization is not attempted.

5.2.08 OVLD Indicator

The **SENSITIVITY** group red **OVLD** indicator lights when overload occurs anywhere in the signal channel, including both pre-filter and post-filter locations. Should this happen, the overload condition must be corrected before valid measurements can be taken. Appropriate actions include changing the dynamic reserve setting, reducing the signal-channel full-scale sensitivity setting, activating the signal channel filter and inserting the line frequency rejection filter.

5.3 FILTERS Group

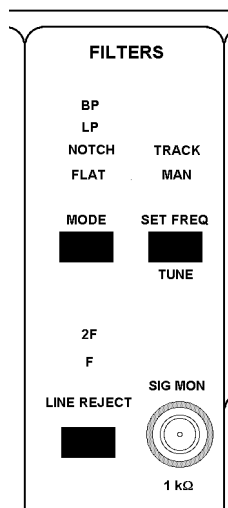

Figure 5-2, FILTERS Group

The keys in this area, shown in figure 5-2, determine the behavior of the main signal channel filter and the line frequency rejection filter. In addition, the output of the signal channel following the input amplifier and filtering stages and prior to the phase sensitive detectors is provided at the **SIG MON** connector.

5.3.01 MODE Key

This key allows the main signal channel filter to be set to one of four characteristics, flat, notch, low-pass and bandpass. Each time the key is pressed the mode changes, so that for example to change from flat to notch mode, press the key once; to change back to flat mode, press the key three times.

A brief description of each filter mode follows.

FLAT Mode

No filtering occurs with this selection and the PSD (phase sensitive detector) is switched to square-wave drive, giving the instrument an overall “square wave” response. In other words, the unit will detect input signals not only at the reference frequency but also at its odd harmonics, with the response to the “ n ”th harmonic being $1/n$ times that at the fundamental.

As a result, for the same amplitude input square wave, the output will be about 23% higher with **FLAT** selected than with **BP** (bandpass) or **LP** (low-pass) selected. With the latter choices, only the fundamental frequency component of the square wave contributes to the output.

BP (bandpass) and LP (low-pass) Modes

When the bandpass or low-pass modes are selected, the PSD is switched to Walsh-function drive. Consequently the overall response of the instrument

becomes fundamental (sinusoidal) since signals at the third and fifth harmonics of the reference frequency are rejected by the PSDs, while higher harmonics are rejected by the signal channel filter. These settings give the maximum dynamic reserve.

The low-pass filter gives maximum rejection of the higher harmonics but allows frequencies below the set frequency to be passed unattenuated to the PSD. The bandpass filter attenuates both above and below the set frequency but with less harmonic rejection than would be provided by the low-pass filter.

NOTCH Mode

The notch filter provides a stop band with very deep attenuation at the set frequency. It is used primarily to remove interference concentrated at a specific frequency or narrow band of frequencies.

5.3.02 SET-FREQ/AUTO Key

This key is primarily used to set the method by which the signal channel filter frequency is adjusted but it is also used to initiate an auto-tune operation.

Filter MAN (manual) mode

Each press of the **SET FREQ/AUTO** key alternately changes the filter frequency-tuning modes between **TRACK** and **MAN** (manual). If the manual mode is selected, then the filter is set to the required frequency by the **PARAMETER ▲** and **▼** keys in the **TUNING** grouping, as follows:

- 1) Select **FIL F** with the **TUNING** Select key, which is the key having the secondary function **AUTO PHASE**. (See section 5.4.01)
- 2) Using the **PARAMETER ▲** and **▼** keys to obtain the desired frequency indication on the **TUNING** LCD.

Filter TRACK mode

If **TRACK** is selected, then the filter frequency is automatically tuned to the reference channel frequency.

NOTE: When the reference circuit is operated in the 2F mode, the filter tunes to twice the reference frequency, unless NOTCH is selected, in which case the filter continues to be tuned to the reference frequency to facilitate second harmonic measurements.

In making fixed frequency measurements, the **TRACK** mode is normally used to set the filter frequency to the reference frequency, and then the mode is switched to **MAN** for the actual signal measurements to take advantage of the superior tuned frequency stability that is provided by that mode.

If the **MAN** tuning mode is active, pressing the **AUTO** key and then the **SET FREQ/AUTO** key causes an auto-tune operation to occur, which sets the filter frequency to the reference frequency (in 2F mode to twice the reference frequency). If the **TRACK** mode is active then auto-tune has no effect.

5.3.03 LINE REJECT Key

This key controls the line frequency rejection filters. The choices are:

- 1) No line filter selected (neither **F** nor **2F** lit).
- 2) **F** (notch tuned to the line frequency; **F** lit).
- 3) **2F** (notch tuned to twice the line frequency; **2F** lit.)
- 4) **F** and **2F** (two notch filters active, one tuned to the line frequency and the other to twice the line frequency; both **F** and **2F** lit.)

The line filters are completely independent of the tuned filter functions previously described. The **F** filter attenuation at the line frequency is more than 34 dB at a stopband of $\pm 1\%$ of the nominal filter frequency.

The actual line frequency (i.e. 60 or 50 Hz) to which the filters are adjusted is set by internal resistors and so cannot be changed by the user. The setting for a given instrument is usually 60 Hz unless there is a label on the rear panel marked "50 Hz Modification Installed"

5.3.04 SIG MON BNC Connector

The signal at this connector is that at the output of the signal channel, immediately prior to the phase sensitive detectors. The gain between the **A** or **A-B** input connectors and this connector depends on the full-scale sensitivity range, on the main signal channel filter setting and on the setting of the dynamic reserve control with the nominal values being given in table 5-1

Full-scale Sensitivity	Gain at Dynamic Reserve Setting		
	High Stability	Normal	High Reserve
3 V	0.3332	0.3332	0.3332
1 V	1	1	1
300 mV	3.332	3.332	3.332
100 mV	10	10	10
30 mV	33.32	3.332	3.332
10 mV	100	10	10
3 mV	333.2	33.32	3.332
1 mV	1000	100	10
300 μ V	3332	333.2	33.32
100 μ V	10000	1000	100.0
30 μ V	33320	3332	333.2
10 μ V	100000	10000	1000
3 μ V	333200	33320	3332
1 μ V	1000000	100000	10000
300 nV	333200	333200	33320
100 nV	1000000	1000000	100000

Table 5-1, Signal Channel Gain, Nominal, A or A-B Input to Sig Mon Output (Bandpass, Low-Pass or Notch Filter Modes)

When the main signal channel filter is inactive, i.e. set to flat, the given figures should be multiplied by 0.790

The signal monitor output is unbuffered, and has an output impedance of 1 k Ω . Internal noise and switching spikes may be present. The higher the reserve setting, the greater their amplitude will be relative to that of the signal.

5.4 TUNING Group

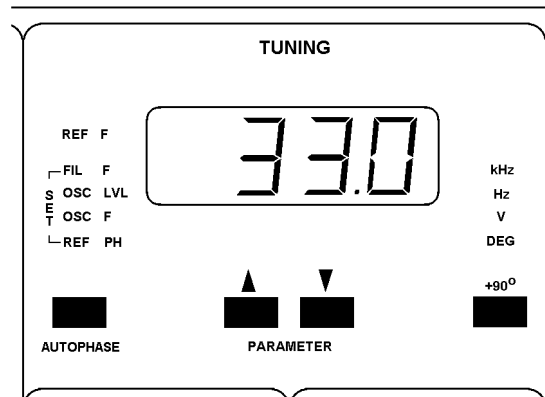

Figure 5-3, TUNING Group

The **TUNING** group, shown above in figure 5-3, contains a 3½ digit LCD display used to set four instrument controls and to display the present reference frequency.

5.4.01 TUNING Select/AUTO PHASE Key

This key is primarily used to specify what is displayed on the **TUNING** group LCD (**TUNING** Select function) but it also has a secondary purpose, which is to initiate an auto-phase operation. It is the left-most key in the **TUNING** area of the panel and can be readily identified by the secondary function legend, **AUTO PHASE**, located beneath it.

Each time the Select/**AUTO PHASE** key is pressed, the value shown on the **TUNING** LCD changes, with the present setting being shown by the relevant indicator being lit, as follows:

SET REF PH (Set reference phase)

When the **SET REF PH** indicator is lit, the LCD displays the present setting, in degrees, of the reference channel phase shifter. The setting can be changed using the **▲** and **▼** **PARAMETER** keys immediately below the LCD.

SET OSC F (Set internal oscillator frequency)

When the **SET OSC F** indicator is lit, the LCD displays the present setting, in Hz or kHz, of the internal oscillator frequency. The setting can be changed using the **▲** and **▼** **PARAMETER** keys immediately below the LCD.

NOTE: *Because the internal oscillator error may be $\pm 1\%$, the actual oscillator frequency obtained may not necessarily agree with the value shown in the OSF F display.*

SET OSC LVL (Set internal oscillator level)

When the **SET OSC LVL** indicator is lit, the LCD displays the present setting, in volts rms, of the internal oscillator output amplitude. The setting can be changed between zero and 1.999 V rms using the **▲** and **▼** **PARAMETER** keys immediately below the LCD. Note also that it is possible to set the amplitude to 5.000 V, but only by using the OA computer command. In the external reference mode the oscillator is independent of the reference channel and can be used for any purpose.

SET FIL F (Set signal-channel filter frequency)

When the **SET FIL F** indicator is lit and if **MAN** tuning mode is selected, the **▲** and **▼** **PARAMETER** keys immediately below the LCD can be used to change the set filter frequency.

REF F

When the **REF F** indicator is lit, the LCD displays the present reference frequency, in Hz or kHz. Reference lock need not be established. As long as a valid reference input signal is present (either internal or external), a valid frequency reading is obtained.

The secondary function of the **TUNING Select/AUTO PHASE** key is to initiate an auto-phase operation. If the red **AUTO** key (located beneath the **TUNING** group) has been pressed, pressing the **TUNING Select/AUTO PHASE** key will cause the reference phase to be adjusted for maximum output.

5.4.02 TUNING **▲** and **▼** **PARAMETER** Keys

As already described above, the **▲** and **▼** **PARAMETER** keys are used to adjust the selected control.

5.4.03 **+90°** Key

The **+90°** key adds 90° to the present setting of the reference phase shifter each time it is pressed, for fast four-quadrant coverage. With the reference signal connected and proper reference channel operation established, the phase is normally adjusted to bring the signal and reference into phase at phase sensitive demodulator. This will result in maximum positive indication on the **OUTPUT** LCD. Maximum negative indication on the **OUTPUT** LCD will occur if the signal and phase are 180° out of phase.

5.5 AUTO Key

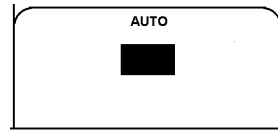

Figure 5-4, AUTO Key

The **AUTO** key, located in its own area beneath the **TUNING** group and shown above in figure 5-4, is used to execute the various auto-functions. The user invokes an auto-function by pressing the **AUTO** key, which causes the red **AUTO** indicator to light, and then the other key assigned to the function required. In each case except for the auto-measure function, the auto-function is an alternative function for the key and is symbolized in red beneath the key. The red **AUTO** indicator remains lit until execution of the auto-function is completed. An auto-function in progress can be terminated by pressing the **AUTO** key once again, except for auto-measure, when it must be pressed twice.

The auto-functions allow easier, faster operation in most applications. However, given the wide range of possible conditions that could occur, there will be times when performing an operation manually will give better results. During several of the auto-functions, decisions are made based on output readings made at a particular moment. Where this is the case, it is important that the time constant set by the operator be long enough to reduce the output noise to a low level for valid decisions to be obtained. A brief description of each auto-function follows.

5.5.01 Auto-Sensitivity

Secondary function of the **SENSITIVITY** ▲ key. This causes the full-scale sensitivity to be adjusted until the output lies within the range of 30% to 100% of full-scale.

5.5.02 Auto-Normalize

Secondary function of the **VERNIER/NORMALIZE** key. Adjusts the sensitivity vernier as required to obtain 100% of full-scale output. A normalize operation always begins with an auto-sensitivity cycle. If none of the sensitivity ranges yield an output between 30% and 110% of full scale, the sensitivity is set to one extreme or the other, normalization is not attempted and the **AUTO** indicator extinguishes

Pressing the **VERNIER/NORMALIZE** key during normalized operation terminates normalized operation and reestablishes calibrated full-scale sensitivity operation.

5.5.03 Auto-Tune

Secondary function of the **SET-FREQ/TUNE** key. If the **MAN** tuning mode is active, pressing the **AUTO** key and then the **SET FREQ/AUTO** key causes an auto-tune operation to occur, which sets the filter frequency to the reference frequency (in 2F mode to twice the reference frequency). If the **TRACK** mode is in effect then auto-

tune has no effect.

5.5.04 Auto-Phase

Secondary function of the **TUNING** select key. Causes the reference channel phase to be adjusted for maximum output. During the auto-phase operation, the output time constant assumes preset values which depend on the reference frequency, but it returns to the original setting on completion of the auto-phase cycle.

5.5.05 Auto-Measure

The auto-measure key, shown in figure 5-5, is located in a small separately delineated area below the **TUNING** section.

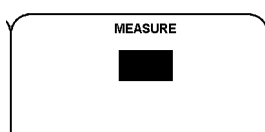

Figure 5-5, MEASURE key

The auto-measure function provides the fastest, easiest way to take a measurement in many situations. When an auto-measure operation is initiated, the following sequence occurs.

- 1) The red **AUTO** indicator lights.
- 2) The signal channel filter is set to the bandpass mode.
- 3) The signal channel filter frequency is tuned to the reference frequency by means of an auto-tune operation.
- 4) An auto-sensitivity operation is performed.
- 5) An auto-phase operation is performed.
- 6) The **AUTO** indicator extinguishes.

5.5.06 Auto-Offset

Alternative function of the **OFFSET** key. If the **AUTO** key is pressed and then the **OFFSET** key, output offset is applied as required to adjust the output to zero. The offset voltage required to do this can be read on the **OUTPUT LCD** when it is set to the **OFFSET** display mode.

5.6 Trigger Conversion Mode Control

The secondary function of the **MEASURE** key is to control the main ADC trigger mode, selection of which is achieved by pressing the green **CONFIG** key followed by the **MEASURE** key.

The trigger mode setting is shown on the **OUTPUT** LCD and adjusted by the **VALUE ▲** and **▼** keys located below and to the left of this display. The trigger mode defines how the instrument's ADC converter, which digitizes the X and Y channel outputs and the voltages applied to the rear-panel **ADC AUX INPUT CH1 - CH4** connectors, is triggered.

There are five different trigger modes, indicated by the code numbers 0, 1, 2, 4 and 8, with the present setting shown on the **OUTPUT** LCD. The setting can be changed using the **VALUE ▲** and **▼** keys located below and to the left of this display. The five settings are as follows:-

Setting “0”: Reference Synchronous Trigger

In this setting, the ADC is triggered synchronously with the reference frequency. The maximum conversion rate is nominally once every 5 ms (200 Hz), so that at low reference frequencies there will be one trigger per reference period. At higher reference frequencies there will be one trigger per some multiple of the reference period.

Each trigger results in the conversion of the output and one of the four **ADC AUX INPUTS**. Thus any given **ADC AUX INPUT** is converted once every four trigger cycles.

Setting “1”: External Trigger Mode

In this setting the ADC is triggered once on each positive going TTL transition detected at rear-panel **ADC EXT TRIG IN** connector. If an applied trigger occurs before the converter has finished processing the previous trigger, it is ignored. On any given trigger, the output and all four of the **ADC AUX INPUTS** are converted.

Setting “2”: Asynchronous Trigger Mode

In this setting the ADC is triggered asynchronously at 100 Hz. On any given trigger, the output and one of the four **ADC AUX INPUTS** is converted. Thus any given **ADC AUX INPUT** is converted once every four trigger cycles (i.e. at a 25 Hz rate).

Setting “4”: Ratio Trigger Mode

In this setting, triggering is synchronous with the reference signal as for mode 0, but only the output and the **ADC AUX INPUT CH1** are converted. The maximum conversion rate is nominally once every 5 ms (200 Hz), so that at low reference frequencies there will be one trigger per reference period. At higher reference frequencies there will be one trigger per some multiple of the reference period.

The advantage of this mode over the reference synchronous trigger mode (mode 0) is that the **ADC AUX INPUT CH1** input is converted at the same rate as the output, giving better results when the instrument is set to the ratio display mode.

NOTE: In the ratio trigger mode, the ADC AUX INPUT CH2, CH3 and CH4 inputs are never converted.

Setting “8”: “8F” Trigger Mode

In this setting, at reference frequencies below 20 Hz, triggering is synchronous with the reference, but there are eight triggers per reference signal period. On any given trigger, the output and one of the four **ADC AUX INPUTS** are converted. Thus any given **ADC AUX INPUT** is converted once every four trigger cycles (i.e. twice per reference cycle). The eight output readings are digitally averaged and it is this averaged value that is displayed and made available for transfer to a computer.

At frequencies above 20 Hz, the trigger mode automatically changes to the asynchronous trigger mode, but 8F triggering is automatically restored if the frequency is subsequently drops to less than 12 Hz.

5.7 Analog Panel Meter

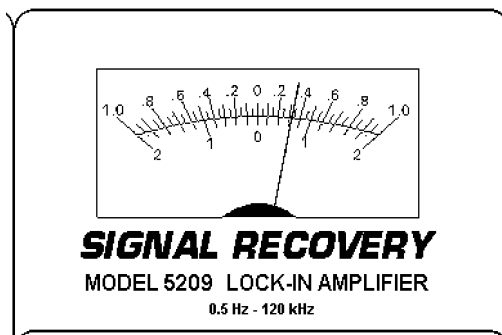

Figure 5-6, Analog Panel Meter

The analog meter, shown above in figure 5-6, always displays the value that is displayed on the **OUTPUT LCD**.

5.8 REFERENCE Group

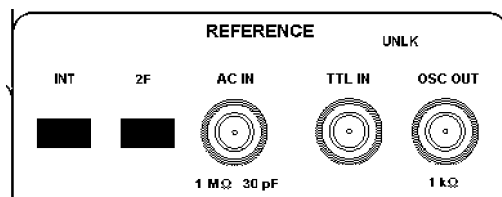

Figure 5-7, REFERENCE Group

The **REFERENCE** group, shown in figure 5-7, contains two keys and associated indicators, a further indicator, the two external reference input BNC connectors, **AC IN** and **TTL IN**, and the internal oscillator output, **OSC OUT**.

5.8.01 INT Key

The left-most key is used to select external or internal reference channel modes, with each press of the key switching between the two states. When the **INT** indicator above

the key is extinguished, it is in the external reference mode, and the reference channel locks to a signal applied to either the **AC IN** or **TTL IN** connectors.

When **INT** is lit, the instrument is in the **INTERNAL** reference mode, and the reference channel locks to the output of the internal oscillator. Where this is the case, the experiment would normally be excited by a signal taken from the **OSC OUT** connector.

5.8.02 2F Key

The second key in this group selects F or 2F operation. When the **2F** indicator is extinguished, F mode is selected and the reference channel operates at the frequency of the applied reference signal or the internal oscillator. When **2F** is lit, 2F mode is selected and the reference channel operates at twice the frequency of the applied reference signal or the internal oscillator.

5.8.03 UNLK indicator

The red **UNLK** (unlock) indicator lights whenever the reference channel loses frequency or phase lock.

5.8.04 AC IN connector

This is the input connector for a general purpose external reference signal. The instrument is fitted with two reference input connectors for external reference mode operation, **TTL IN** and **AC IN**. Wherever possible, use the TTL input, particularly if the reference signal is asymmetrical. If the available reference is not suitable for driving a TTL input, then use the **AC IN** reference input.

The input impedance at this connector is 1 M Ω in parallel with 30 pF.

5.8.05 TTL IN connector

This connector is provided to allow TTL compatible pulses to be used as the reference input when operating in external reference mode. Wherever possible, it should be used in preference to the **AC IN** connector.

NOTE: Do not apply a reference to both the AC IN and TTL IN connectors simultaneously, since this will result in incorrect operation of the reference channel.

5.8.06 OSC OUT connector

This is the output connector for the internal oscillator, which may be set to generate a sine wave between 0.5 Hz and 120 kHz with amplitude between 1 mV and 1.999 V rms.

NOTE: Although the output impedance at this connector is shown on the front panel as 1 k Ω , it is in fact nominally 900 Ω

5.9 OUTPUT Group

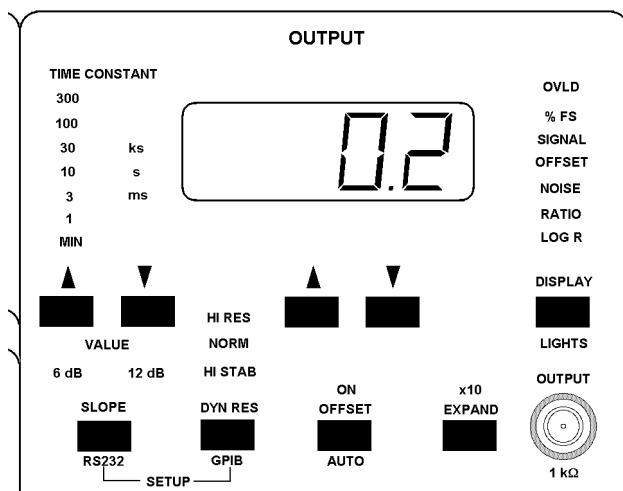

Figure 5-8, OUTPUT Group

The **OUTPUT** group, shown above in figure 5-8, contains an LCD and a control to select which of the possible instrument outputs are displayed on it and the analog panel meter. In addition, the group contains controls for the output filter time constant and slope, dynamic reserve, offset, output expansion, and the RS232 and GPIB communications interface settings, and a BNC connector for the analog output signal.

5.9.01 TIME CONSTANT ▲ and ▼ VALUE Keys

The primary function of these keys is simply to set the value of the time constant. The longer the time constant, the narrower the lock-in amplifier's noise bandwidth will be and the greater the improvement in signal-to-noise ratio. This improvement is obtained at the expense of increased response time.

Time constants between 1 ms and 300 ks may be set in a 1-3-10 sequence, with the present setting being shown by the relevant figure and units indicators being lit.

The keys are also used in conjunction with the green **CONFIG** key to set the RS232 and GPIB communications interface settings. This is described later in section 5.10.03.

5.9.02 SLOPE/RS232 Key

The primary function of this key is to set the output filter's roll-off rate to either 6 dB/octave or 12 dB/octave. 12 dB/octave gives better filtering but cannot be used in some experimental situations (for instance, where the Model 5209 is incorporated into a feedback loop). The setting is indicated by the relevant **6 dB** or **12 dB** indicator being lit.

The key also has a secondary function when used with the green **CONFIG** key to select a display of the RS232 interface settings on the **TUNING** and **OUTPUT** LCDs

so that these can be changed. This is described later in section 5.10.03

5.9.03 DYN RES/GPIB Key

This is another dual-function key. Its primary function is set the dynamic reserve to high stability, normal or high reserve modes, with the present setting being indicated by the associated **HI STAB**, **NORM** and **HI RES** indicators. The dynamic reserve in **FLAT** filter mode (i.e. with no signal channel filter active) is 20 dB, 40 dB, or 60 dB respectively. Dynamic reserve and output stability are tradeoff parameters, so that the **HI STAB** setting gives an output stability of 5 ppm/°C, **NORM** gives 50 ppm/°C and **HI RES** 500 ppm/°C. The best overall measurement results are therefore obtained with a reserve setting no higher than is necessary to prevent instrument overload. Improving the dynamic reserve by using the input filters does not adversely affect the output stability.

The key also has a secondary function when used with the green **CONFIG** key to select a display of the GPIB interface settings on the **TUNING** and **OUTPUT** LCDs so that these can be changed. This is described later in section 5.10.03

5.9.04 OFFSET/AUTO Key

This is a four-function key. If pressed alone, it simply turns the offset ON or OFF. If an output offset is being applied to the output, then the **ON** indicator above the key is lit. If pressed in conjunction with the **AUTO** key, it initiates an auto-offset cycle. If pressed in conjunction with the **CONFIG** key, it toggles the digimeter mode for the analog panel meter, and if used with the **OUTPUT OFFSET** display mode it can be used to set the voltage appearing at the rear-panel auxiliary **DAC 1** and **DAC 2** outputs

Offset ON/OFF

Offset ON

When the offset **ON** indicator is lit, the value of offset previously set is applied. The offset level can be set when **OFFSET** is selected for display on the **OUTPUT** LCD.

Offset off.

When the offset **ON** indicator is unlit, no offset is applied, although any previously-set level is retained in memory.

Auto-Offset

If the **AUTO** key is pressed and then the **OFFSET/AUTO** key, output offset is applied as required to adjust the output to zero. The offset voltage required to do this can be read on the **OUTPUT** LCD, when this is set to the **OFFSET** display mode.

Digimeter Mode Control

The output filters used in the model 5209 normally use analog techniques for time-constants of 3 s and shorter, with digital methods used at longer settings. When the digital filter is used, the analog panel meter (and **OUT** output) are driven by the output of a digital to analog converter.

When digimeter mode is turned on, the analog panel meter is driven by the output of the digital to analog converter at all time constant settings. The mode is primarily intended for use in the 8F trigger mode, and causes the reading on the analog meter to be averaged in the same way as that on the **OUTPUT LCD**.

Digimeter mode is toggled on or off by pressing **CONFIG**, **OFFSET/AUTO** and **CONFIG** again.

NOTE: The digimeter mode is always turned OFF at power-up.

DAC Set

The voltage at the rear-panel auxiliary **DAC AUX OUT CH1** and **CH2** connectors can be set using the following procedure:-

- 1) Press the **OFFSET/AUTO** key and set the desired output voltage using the ▲ and ▼ keys located below the **OUTPUT LCD** display.
- 2) Press the red **AUTO** key.
- 3) Press the ▲ key located below the **OUTPUT LCD** display **once** to set the **DAC AUX OUT CH1** voltage to the preset value; press the ▼ key located below the **OUTPUT LCD** display **once** to set the **DAC AUX OUT CH2** voltage to the preset value.

5.9.05 OUTPUT LCD ▲ and ▼ keys

The ▲ and ▼ keys below the **OUTPUT LCD** set the offset value as follows:-

- 1) Set the **OUTPUT LCD** to the **OFFSET** mode using the **DISPLAY/LIGHTS** key, discussed later in section 5.9.07.
- 2) The actual offset level is shown on the **OUTPUT LCD** and can be adjusted using the ▲ and ▼ keys below the **OUTPUT LCD**.

The established value of offset remains in effect until changed.

5.9.06 EXPAND Key

The **EXPAND** key toggles the output expansion mode, in which an additional gain of 10 is applied to the output, after any applied offset. If the mode is on then the **X10** indicator above the key is lit.

5.9.07 DISPLAY/LIGHTS Key

The primary purpose of the **DISPLAY/LIGHTS** key is to select the instrument outputs that are displayed on the **TUNING** and **OUTPUT LCDs** and on the analog panel meter. Each press of the key changes the output(s) selected, so that, for example, to change from the **% FS** to the **SIGNAL** mode the key should be pressed once; to return to the **% FS** mode it should be pressed a further five times. The present selection is shown by the relevant indicator being lit, and remains in effect until

changed.

% FS Display Mode

When set to the **% FS** mode, the **OUTPUT** LCD and the analog panel meter indicate the output expressed as a percentage of the present full-scale sensitivity. With the reference phase shifter adjusted for maximum output, a full-scale input signal will give an **OUTPUT** LCD indication of 100%, a positive full-scale deflection of the analog panel meter and +10 V at the **OUT** output connector.

SIGNAL Display Mode

This setting operates in the same way as the **% FS** mode except that, if the sensitivity is set to a “3 range”, a full-scale input will give an LCD indication of “3”, “30” or “300”, as opposed to the “100” indication that would occur if **% FS** were selected. This allows the input signal amplitude, in voltage or current units, to be read directly from the LCDs.

For example, if the full-scale sensitivity is set to **30 mV**, the reference phase shifter adjusted for maximum output and a 20 mV sinusoidal signal applied, then the **OUTPUT** LCD indication will be 20. The units applying to this figure are those shown by the lit units indicator in the **SENSITIVITY** section, in this case “**mV**”. Hence the measured signal is 20 mV rms.

In the **SIGNAL** mode, the analog meter indication and the output level provided at the **OUT** connector are the same as for **% FS** mode.

OFFSET Display Mode.

This setting displays on the **OUTPUT** LCD the offset value in effect, which can be adjusted using the **▲** and **▼** keys beneath the **OUTPUT** LCD over the range ± 150.0 , corresponding to $\pm 150\%$ of full-scale. As already mentioned earlier in section 5.9.04, the offset is turned on or off with the **OFFSET/AUTO** key.

In the **OFFSET** mode, the analog meter indication and the output level provided at the **OUT** connector are the same as for **% FS** mode.

NOISE Display Mode

In this setting, the **OUTPUT** LCD and the analog meter both indicate the rectified output noise as a percentage of the present full scale sensitivity setting. The noise processor is a simple, broadband, full-wave rectifier with an output smoothing time constant of 10.24 s. It is AC coupled (coupling time constant also 10.24 s) to the output.

The calibration is the same as the calibration in the **% FS** mode, i.e., the output reading is the same as would be obtained by averaging the magnitude of the output display reading, apart from the effect of the AC coupling.

Considering any sinusoidal component of the noise, the response of the lock-in amplifier is 3 dB less (in rms terms) than the response of an in-phase signal. This is the "phase-sensitive advantage" and has traditionally been expressed by the statement that the so-called equivalent noise bandwidth is 1/4TC for 6 dB/octave

and 1/8TC for 12 dB/octave (where TC is the time-constant, in seconds), although the actual spectral bandwidth is double this.

The purpose of the AC coupling is to allow noise measurements to be made in the presence of a steady signal. If the signal varies significantly over a 10 second timescale, it will contribute to the measured noise. It is intended that noise measurements should normally be made with a time constant much less than 10 s.

The AC coupling will cut off the lowest-frequency noise components, with a lower cutoff frequency of 0.0155 Hz. This has the effect of reducing the equivalent noise bandwidth (ENBW) below the usually quoted values of 1/(4TC) Hz for 6 dB/octave and 1/(8TC) for 12 dB/octave. The corrected values are given in table 5-2

TC (seconds)	Bandwidth (Hz)	
	6 dB/oct	12 dB/oct
3.0	0.06445	0.02492
1.0	0.2278	0.1037
0.3	0.8096	0.3933
0.1	2.476	1.226
0.03	8.309	4.142
0.01	24.08	10.40
0.003	83.31	41.64
0.001	250.0	125.0

Table 5-2, ENBW of 5209 in Noise Measurement Mode

Note that these values are half of those that would be obtained with sinusoidal measurements over a range of noise frequencies close to the reference frequency. The formula for noise bandwidth, *NBW*, is:

$$NBW = \frac{\left(\int (\text{gain}^2 \cdot df) \right)}{(\text{gain at center frequency})^2}$$

If, as is usually the case, the amplitude distribution of the noise being measured is Gaussian rather than sinusoidal, then a correction factor needs to be applied to the displayed reading. This is the ratio (Gaussian rms-to-mean ratio)/(sinusoidal rms-to-mean ratio):

$$= \frac{\sqrt{\frac{\pi}{2}}}{\left(\frac{\pi}{2 \times \sqrt{2}} \right)}$$

$$= 1.1284$$

This correction factor is applicable to the "flat" main signal channel filter setting where the multiplying function is a square wave. If the filter is in the low-pass or

band-pass mode, an additional factor must be taken into account. The filter has a Q -factor of 2 and thus its bandwidth introduces only a negligible reduction in the equivalent noise bandwidth of the measurement. However, these filter modes switch in the "Walsh Function" demodulator and this does affect the noise measurement. The stepped approximation to a sinewave response of this demodulator adds the additional factor:

$$\sqrt{\frac{2}{\left(\frac{1}{2^2} + \left(\frac{1}{2} + \frac{1}{\sqrt{2}}\right)^2\right)}}$$

$$= 1.0824$$

This factor when combined with the correction for Gaussian noise amplitude distributions yields an overall correction for the low pass or bandpass modes of:

$$1.1284 \times 1.0824 = 1.2214$$

Hence, for example, if the instrument is being used in the noise measurement mode, the full-scale sensitivity is 100 nV, the **OUTPUT** LCD shows a reading of 80%, and the input noise amplitude distribution is Gaussian then the true noise level is $80\% \times 100 \text{ nV} \times 1.2214$, or 97.71 nV. To obtain the noise spectral density, simply divide this figure by the square root of the equivalent noise bandwidth corresponding to the present time-constant and slope setting, as given in table 5-2.

In the **NOISE** mode, the output level provided at the **OUT** connector ranges from 0 to +15 V, with +10 V corresponding to a reading of 100% on the **OUTPUT** LCD

RATIO Display Mode

When the **RATIO** mode indicator is lit the **OUTPUT** LCD and the analog panel meter indicate the result of the RATIO calculation, which is defined as follows:-

$$\text{RATIO} = \left(\frac{\text{Output}}{\text{CH1 Input}} \right)$$

where Output is the instrument's output with +10 V = 100 % full-scale sensitivity and CH1 Input is the voltage applied to the **ADC AUX INPUT CH1** input connector on the rear panel. Hence, for example, if the instrument were measuring a 100 mV signal when set to the 300 mV sensitivity setting, the output were maximized and a 1 V signal were applied to the **ADC AUX INPUT CH1** input, then the value of RATIO would be:-

$$\text{RATIO} = \left(\frac{10 \times \frac{0.1}{0.3}}{1.000} \right)$$

$$\text{RATIO} = 3.333$$

The result of the ratio calculation is also presented as an analog voltage at the **OUT** output connector, and is related to the ratio as follows:

RATIO	OUT Voltage (volts)
+15	15.0
+10	10.0
0	0.0
-10	-10.0
-15	-15.0

and so in the above example, the **OUT** output would be 3.333 V.

LOG R (Log Ratio) Display Mode

When the **LOG R** mode indicator is lit the **OUTPUT** LCD and the analog panel meter indicate the result of the LOG RATIO calculation, which is defined as follows:-

$$\text{LOG RATIO} = \log_{10} \left(\frac{\text{Output}}{\text{CH 1 input}} \right)$$

where Output is the instrument's output with +10V = 100 % full-scale sensitivity and CH1 Input is the voltage applied to the **ADC AUX INPUT CH1** input connector on the rear panel. Hence, for example, if the instrument were measuring a 100 mV signal when set to the 300 mV sensitivity setting, the output were maximized and a 1 V signal were applied to the **ADC AUX INPUT CH1** input, then the value of LOG RATIO would be:-

$$\text{LOG RATIO} = \log_{10} \left(\frac{10 \times \frac{0.1}{0.3}}{1.000} \right)$$

$$\text{LOG RATIO} = 0.523$$

The result of the log ratio calculation is also presented as an analog voltage at the **OUT** output connector, and is related to the ratio as follows:

LOG RATIO	OUT Voltage (volts)
+1.999	1.999
0	0.0
-1.999	-1.999

and so in the above example, the **OUT** output would be 0.523 V.

Note: If $\text{RATIO} < 0$ then $\text{LOG RATIO} = -1.999$

The **DISPLAY/LIGHTS** key also has a secondary function, when used with the green **CONFIG** key, which is to turn the front-panel indicators off and on. This is described later in section 5.10.03

5.9.08 OVLD Indicator

The red **OVLD** indicator in the top right-hand corner of the **OUTPUT** group lights when either output channel is overloaded. Output overloads may be removed by one or more of the following actions: reducing the signal-channel sensitivity, inserting the tracking filter or line frequency notch filter, increasing the output time constant, turning off the output expansion function, selecting a higher dynamic range, or establishing a more appropriate value of output offset (including turning it off).

5.9.09 OUT Connector

The **OUT** connector provides the main analog output of the instrument. It has a range of ± 15 V, with ± 10 V corresponding to $\pm 100\%$ full-scale. The output impedance is nominally 1 k Ω .

The actual voltages present on this connector depend on the output selected for display in the **OUTPUT** section, as described earlier in section 5.9.07.

5.10 Interface Group

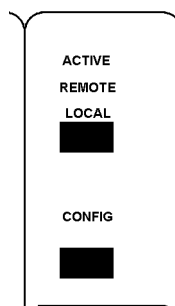

Figure 5-9, Interface Group

The interface group, shown in figure 5-9, includes two keys and four indicators, as follows:

5.10.01 ACTIVE Indicator

This indicator lights when the 5209 is processing commands from either the RS232 or GPIB communications interfaces. If it remains lit, the most likely reason is that a byte is waiting to be read from the GPIB interface.

5.10.02 LOCAL Key

This key allows the front panel controls to be locked out. Its status is given by the

associated **REMOTE** indicator. When the **REMOTE** legend above the key is extinguished, all front-panel controls are operative. When **REMOTE** is lit, the front-panel controls have no effect (with the exception of the **LOCAL** key, which is always operational). The GPIB and RS232 ports are always active.

5.10.03 CONFIG Key

This key is tuns the configuration mode on and off, with the present status being shown by the green **CONFIG** indicator above the key. When the indicator is lit, normal instrument operation is suspended, and three other keys allow the communications interface controls to be set and read, and the display lights to be turned off or on.

In addition, if the **CONFIG** key is pressed twice, the first press causes the GPIB SDC (Selected Device Clear) function to be generated internally. This will clear the buffers, initialize the GPIB Interface, set the value of the Serial Poll Status Byte to "1", and transfer the system out of the OUTFF or * data transmission mode, established via the OUTFF or * commands. The second press restores normal instrument operation.

The alternative functions selected by pressing **CONFIG** followed by another key are as follows:

CONFIG + SLOPE/RS232C keys

Pressing the **CONFIG** key followed by the **SLOPE/RS232C** keys allows the RS232 communications settings to be set or read. In this mode, the **TUNING LCD** shows a control code, either "0" or "1", while the **OUTPUT LCD** shows a value code corresponding to the control code. The control code can be changed using the **PARAMETER ▲** and **▼** keys beneath the **TUNING LCD**, and the value code can be adjusted using the **VALUE ▲** and **▼** keys below and to the left of the **OUTPUT LCD**.

The settings are as follows:-

RS232 Baud Rate Control: TUNING LCD = "0"

When the **TUNING LCD** shows a "0", the **OUTPUT LCD** shows the baud rate value code. To change the baud rate (range 110 baud to 19.2 kilobaud), use the **VALUE ▲** and **▼** keys below and to the left of the **OUTPUT LCD** to obtain the required value code. The baud rates corresponding to each value code are as follows:

Value Code	Baud Rate
0	75
1	110
2	134.5
3	150
4	300
5	600
6	1200
7	2000
8	2400
9	4800
10	1800
11	9600
12	19200

RS232 Other Parameters Control: TUNING LCD = "1"

When the **TUNING** LCD shows a "1", the **OUTPUT** LCD shows a value code which determines the setting of the other five RS232 interface controls, i.e. Number of Data Bits, Parity Odd or Even, Parity On or Off, Number of Stop Bits and Character Echo status. To change these controls, use the **VALUE** ▲ and ▼ keys below and to the left of the **OUTPUT** LCD to obtain the required value code.

The value code is a decimal number between 0 and 31 given by the sum of five numbers, as follows:

Control Setting	Value
Seven Data Bits	0
Eight Data Bits	1
Even Parity	0
Odd Parity	2
Parity ON	0
Parity OFF	4
One Stop Bits	0
Two Stop Bit	8
RS232 Echo OFF	0
RS232 Echo ON	16

For example, a value code of 16 would indicate:

DATA BITS: 7
 PARITY: ON and EVEN
 STOP BITS: 1
 RS232 ECHO: ON

Once the RS232 interface controls are set as required, press the **CONFIG** key again to restore normal instrument operation.

CONFIG + DYN RES/GPIB keys

Pressing the **CONFIG** key followed by the **DYN RES/GPIB** keys allows the GPIB communications settings to be set or read. In this mode, the **TUNING LCD** shows a control code, either “0” or “1”, while the **OUTPUT LCD** shows a value code corresponding to the control code. The control code can be changed using the **PARAMETER ▲** and **▼** keys beneath the **TUNING LCD**, and the value code can be adjusted using the **VALUE ▲** and **▼** keys below and to the left of the **OUTPUT LCD**.

GPIB Address Control: TUNING LCD = “0”

When the **TUNING LCD** shows a "0", the **OUTPUT LCD** shows the GPIB address. To change the address (range 0 to 31), use the **VALUE ▲** and **▼** keys below and to the left of the **OUTPUT LCD**.

GPIB Terminator and GPIB Test Echo Controls:

TUNING LCD = “1”

When the **TUNING LCD** shows a "1", the **OUTPUT LCD** shows a value code which sets the termination and test echo controls. To change these controls, use the **VALUE ▲** and **▼** keys below and to the left of the **OUTPUT LCD** to obtain the required value code.

The value code is a decimal number between 0 and 3, as follows:-

Value Code	Function
0	<CR>, Test Echo OFF
1	<CR>, Test Echo ON
2	<CR,LF>, Test Echo OFF
3	<CR,LF>, Test Echo ON

where <CR> indicates the Carriage Return (ASCII 13) and <LF> the Line Feed (ASCII 10) terminator characters.

The 5209 accepts as GPIB input terminator whichever terminator option is selected. A controlling computer, on the other hand, will probably operate with only one terminator or the other, making it essential that the correct terminator be selected. Frequently, the easiest way to determine which terminator the computer requires is to simply try them both and see which one works.

When the test echo function is turned on, every character transmitted or received via the GPIB interface is echoed to the RS232 interface. This mode can be useful when troubleshooting GPIB communications problems.

NOTE: Test Echo should be turned off when it is not in use since it slows down GPIB communications.

Pressing the **CONFIG** key again restores normal operation.

CONFIG + DISPLAY/LIGHTS keys

The **CONFIG** key is also used with the **DISPLAY/LIGHTS** key to turn the front-panel indicators off and on. Operation with the lights turned off is often useful in those

optical experiments where stray light must be minimized.

To turn the lights off, first press the **CONFIG** key and then the **DISPLAY/LIGHTS** key. All lights will immediately extinguish but the 5209 will not operate correctly. When **CONFIG** is pressed a second time, normal lock-in amplifier operation (with all panel lights extinguished) will be established.

To turn the lights on, first press **CONFIG** key and then the **DISPLAY/LIGHTS** key. The panel lights will become operational but the lock-in amplifier will not operate correctly. When **CONFIG** is pressed a second time, normal lights-on operation of the lock-in amplifier will return.

5.11 POWER on/off key

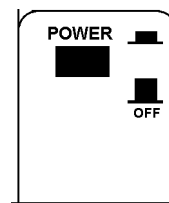

Figure 5-10, POWER on/off key

The **POWER** on/off key, shown in figure 5-10, controls the line power to the instrument. In the latched (in) position, the power is on. In the released (out) position, it interrupts both sides of the AC power to the primary of the power transformer.

5.12 Typical Lock-in Amplifier Experiment

The model 5209 is a complex instrument with many controls and so readers may find the following basic checklist helpful in setting up the instrument for manual operation.

Selection of Signal Input

Use the upper four right-hand interlocking keys in the **SENSITIVITY** group to select voltage (single ended or differential) or current input mode, and connect the signal source to the relevant **A** and/or **B/I VIR GND** input connector(s).

Selection of Reference Mode

Use the reference source selection control in the **REFERENCE** group to set the instrument to internal reference mode, assuming that the internal oscillator will be used as a source of excitation to your experiment. Use the **SET OSC LVL** oscillator amplitude and **SET OSC F** frequency controls in the **TUNING** group to set the required oscillator output, and connect the output signal from the **OSC OUT** connector to the experiment.

If using external reference mode, use the reference source selection control in the **REFERENCE** group to set the instrument to external reference mode, and connect the reference signal to either **AC IN** or **TTL IN** reference input connectors.

Auto-Measure

Press the red **AUTO** key followed by the **MEASURE** key to perform an auto-measure operation, which will set the instrument so that it is correctly measuring the signal.

Other Adjustments

Use the **OUTPUT** selection key to set the output LCD so that it is displaying the required instrument output.

6.1 Introduction

The model 5209 includes both RS232 and GPIB (IEEE488) interface ports, designed to allow the lock-in amplifier to be completely controlled from a remote computer. Virtually all of the instrument's controls may be operated, and all the outputs read, via these interfaces. In addition, there are a few functions, such as setting the internal oscillator output amplitude to +5.000 V rms and initiating an auto-calibration cycle which can only be accessed remotely.

This chapter describes the capabilities of the instrument when operated remotely and discusses how this is done.

6.2 Capabilities

6.2.01 General

All instrument controls which may be set using the front panel keys may also be set remotely, with the exception of the selection of voltage or current input mode, the current mode converter settings and the setting of the input BNC connector's float/ground status. In addition, the present setting of each control, with the exception of the input BNC connector's float/ground status, may be determined by the computer. All instrument outputs which may be displayed on the front panel may also be read remotely.

When operated via the interfaces, the following features are also available:

6.2.02 Oscillator amplitude - additional output setting

The front panel **OSC LVL** control allows the internal oscillator amplitude to be set to voltages between 1 mV and 1.999 mV rms. However, when setting this voltage by computer command, it may also be set to 2.000 V and 5.000 V rms.

6.2.03 Automatic ADC Converter Correction

The instrument includes a number of analog to digital converters, which, due to long-term DC drift, may give a non-zero output with zero input. The instrument therefore responds to a command which allows any such errors to be automatically corrected.

6.3 RS232 and GPIB Operation

6.3.01 Introduction

Control of the lock-in amplifier from a computer is accomplished by means of communications over the RS232 or GPIB interfaces. The communication activity consists of the computer sending commands to the lock-in amplifier, and the lock-in amplifier responding, either by sending back some data or by changing the setting of

one of its controls. The commands and responses are encoded in standard 7-bit ASCII format, with one or more additional bits as required by the interface (see below).

The two ports cannot be used simultaneously, but when a command has been completed, the lock-in amplifier will accept a command at either port. Also when the test echo facility has been activated all output from the computer to the GPIB can be monitored by a terminal attached to the RS232 connector.

Although the interface is primarily intended to enable the lock-in amplifier to be operated by a computer program specially written for an application, it can also be used in the direct, or terminal, mode. In this mode the user enters commands on a keyboard and reads the results on a video screen.

The simplest way to establish the terminal mode is to connect a standard terminal, or a terminal emulator, to the RS232 port. A terminal emulator is a computer running special purpose software that makes it act as a terminal. In the default (power-up) state of the port, the lock-in amplifier sends a convenient prompt character when it is ready to receive a command, and echoes each character that is received.

Microsoft Windows versions 3.1 and 3.11 include a program called Terminal, and Windows 95 a program called Hyperterminal, usually in the Accessories group, which may be used as a terminal emulator. On the other hand, a simple terminal program with minimal facilities can be written in a few lines of BASIC code (see appendix C.1).

6.3.02 RS232 Interface - General Features

The RS232 interface in the model 5209 is implemented with three wires; one carries digital transmissions from the computer to the lock-in amplifier, the second carries digital transmissions from the lock-in amplifier to the computer and the third is the logic ground to which both signals are referred. The logic levels are $\pm 12V$ referred to logic ground, and the connection may be a standard RS232 cable in conjunction with a null modem or alternatively may be made up from low-cost general purpose cable. The pinout of the RS232 connector is shown in appendix B and cable diagrams suitable for coupling the instrument to a computer are shown in appendix D.

The main advantages of the RS232 interface are:

- 1) It communicates via a serial port which is present as standard equipment on nearly all computers, using leads and connectors which are available from suppliers of computer accessories or can be constructed at minimal cost in the user's workshop.
- 2) It requires no more software support than is normally supplied with the computer, for example Microsoft's GWBASIC, QBASIC or Windows Terminal or Hyperterminal mode.

A single RS232 transmission consists of a start bit followed by 7 or 8 data bits, an optional parity bit, and 1 stop bit. The rate of data transfer depends on the number of bits per second sent over the interface, usually called the baud rate. In the model 5209

the baud rate can be set to a range of different values up to 19,200, corresponding to a minimum time of less than 0.5 ms for a single character.

Mostly for historical reasons, there are a very large number of different ways in which RS232 communications can be implemented. Apart from the baud rate options, there are choices of data word length (7 or 8 bits), parity check operation (even, odd or none), and number of stop bits (1 or 2). These settings may be adjusted using the **CONFIG** and **SLOPE/RS232** keys, as described in section 5.10.03. They may also be adjusted by means of the RS command.

NOTE: In order to achieve satisfactory operation, the RS232 settings must be set to exactly the same values in the terminal or computer as in the lock-in amplifier.

6.3.03 Choice of Baud Rate

Where the lock-in amplifier is connected to a terminal or to a computer implementing an echo handshake, the highest available baud rate of 19,200 is normally used if, as is usually the case, this rate is supported by the terminal or computer. Lower baud rates may be used in order to achieve compatibility with older equipment or where there is some special reason for reducing the communication rate.

6.3.04 Choice of Number of Data Bits

The model 5209 lock-in amplifier uses the standard ASCII character set, containing 127 characters represented by 7-bit binary words. If an 8-bit data word is selected, the most significant bit is set to zero on output from the lock-in amplifier and ignored on input. The result is that either the 8-bit or the 7-bit option may be used, but the 7-bit option gives slightly faster communication.

6.3.05 Choice of Parity Check Option

Parity checks are not required at the baud rates available in the model 5209, that is up to 19,200 baud, with typical cable lengths of up to a few meters. Therefore no software is provided in the model 5209 for dealing with parity errors. Where long cables are in use, it may be advisable to make use of a lower baud rate. The result is that any of the parity check options may be used, but the parity off option will result in slightly faster communication.

Where the RS232 parameters of the terminal or computer are capable of being set to any desired value, an arbitrary choice must be made. In the model 5209 the combination set at the factory is even parity check, 7 data bits, and one stop bit because these are the MSDOS default.

6.3.06 GPIB Interface General Features

The GPIB is a parallel digital interface with 8 bi-directional data lines, and 8 further lines which implement additional control and communication functions. Communication is through 24-wire cables (including 8 ground connections) with special-purpose connectors which are constructed in such a way that they can be stacked on top of one another to enable numerous instruments to be connected in parallel. By means of internal hardware or software switches, each instrument is set to

a different address on the bus, usually a number in the range 0 to 31. In the model 5209 the address is set using the **CONFIG** and **DYN RES/GPIB** keys, discussed in section 5.10.03 or by means of the GP command.

A most important aspect of the GPIB is that its operation is defined in minute detail by the IEEE488 standard, usually implemented by special purpose semiconductor devices that are present in each instrument and communicate with the instrument's microprocessor. The existence of this standard greatly simplifies the problem of programming the bus controller, i.e. the computer, to implement complex measurement and test systems involving the interaction of numerous instruments. There are fewer interface parameters to be set in the lock-in amplifier than with RS232 communications.

The operation of the GPIB requires the computer to be equipped with special-purpose hardware, usually in the form of a plug-in card, and associated software which enable it to act as a bus controller. The control program is written in a high-level language, usually BASIC or C, containing additional subroutines implemented by software supplied by the manufacturer of the interface card.

Because of the parallel nature of the GPIB and its very effective use of the control lines including the implementation of a three-wire handshake (see below), comparatively high data rates are possible, up to a few hundred thousand bytes per second. In typical setups the data rate of the GPIB itself is not the factor that limits the rate of operation of the control program.

6.3.07 Handshaking and Echoes

A handshake is a method of ensuring that the transmitter does not send a byte until the receiver is ready to receive it, and, in the case of a parallel interface, that the receiver reads the data lines only when they contain a valid byte.

GPIB Handshaking

The GPIB interface includes three lines (*DAV, *NRFD, *NDAC) which are used to implement a three-wire handshake. The operation of this is completely defined by the IEEE488 standard and is fully automatic, so that the user does not need to know anything about the handshake when writing programs for the GPIB. Note that each command must be correctly terminated.

RS232 Handshaking

In the RS232 standard there are several control lines called handshake lines (RTS, DTR outputs and CTS, DSR, DCD inputs) in addition to the data lines (TD output and RD input). However, these lines are not capable of implementing the handshaking function required by the model 5209 on a byte-by-byte basis and are not connected in the model 5209 apart from the RTS (request to send) output and CTS (clear to send) input, which operate as follows:-

The RTS output is asserted when the 5209's input buffer is not full, i.e. when the instrument is ready to receive the next byte.

The CTS input determines whether the 5209 will transmit data to the controlling

computer. When the line is asserted by the computer, the 5209 will transmit data; when not asserted, data transmission is suspended. If this line is not connected, it assumes the asserted state, allowing data transmission from the instrument to occur.

Note that some computer applications require one or more of the computer's RS232 handshake lines to be asserted. If this is the case, and if the requirement cannot be changed by the use of a software switch, the cable may be used in conjunction with a null modem. A null modem is an adapter which connects TD on each side through to RD on the other side, and asserts CTS, DSR, and DCD on each side when RTS and DTR are asserted on the other side.

With most modern software there is no need to use any of the RS232 handshake lines and a simple three-wire connection can be used. The actual handshake function is then performed by means of bytes transmitted over the interface.

The more critical handshake is the one controlling the transfer of a command from the computer to the lock-in amplifier, because the computer typically operates much faster than the lock-in amplifier and bytes can easily be lost if the command is sent from a program. (Note that because of the limited speed of human typing, there is no problem in the terminal mode.) Therefore an *echo handshake* is used, which works in the following way: after receiving each byte, the lock-in amplifier sends back an echo, that is a byte which is a copy of the one that it has just received, to indicate that it is ready to receive the next byte. Correspondingly, the computer does not send the next byte until it has read the echo of the previous one. Usually the computer makes a comparison of each byte with its echo, and this constitutes a useful check on the validity of the communications.

Where the echo is not required, it can be suppressed by negating bit 3 in the RS232 parameter byte. The default (power-up) state of this bit is for it to be asserted.

The program RSCOM2.BAS in section C.2 illustrates the use of the echo handshake.

6.3.08 Terminators

In order for communications to be successfully established between the lock-in amplifier and the computer, it is essential that each transmission, i.e. command or command response, is terminated in a way which is recognizable by the computer and the lock-in amplifier as signifying the end of that transmission.

In the model 5209 there are two input termination options for GPIB communications, selected from the front panel using the **CONFIG** and **DYN RES/GPIB** keys or by means of the GP command. The lock-in amplifier may be set to expect the <CR> byte (ASCII 13) or the <CR,LF> sequence (ASCII 13 followed by ASCII 10) to be appended by the controller as a terminator to the end of each command.

The selected GPIB termination option applies also to the output termination of any responses sent back by the lock-in amplifier to the controller, i.e. the lock-in amplifier will send <CR> or <CR,LF> as appropriate. In all cases the lock-in amplifier asserts the GPIB EOI (end or identify) signal line during the transmission of the last byte of a

response.

In RS232 communications, the lock-in amplifier automatically accepts either <CR> or <CR,LF> as an input command terminator, and sends out <CR,LF> as an output response terminator.

6.3.09 Command Format

The simple commands listed in section 6.4 have one of five forms:

CMDNAME terminator
CMDNAME n terminator
CMDNAME [n] terminator
CMDNAME [n₁ [n₂]] terminator
CMDNAME n₁ [n₂] terminator

where CMDNAME is an alphanumeric string that defines the command, and n, n₁, n₂ are parameters separated by spaces. When n is not enclosed in square brackets it must be supplied. [n] means that n is optional. [n₁ [n₂]] means that n₁ is optional and if present may optionally be followed by n₂. Uppercase and lowercase characters are equivalent. Terminator bytes are defined in section 6.3.08.

NOTE: Where the command syntax includes optional parameters and the command is sent without the optional parameters, the response consists of a transmission of the present values of the parameter(s).

Any response transmission consists of one or more numbers followed by a response terminator. Where the response consists of two or more numbers in succession, they are separated by a delimiter (section 6.3.10).

6.3.10 Delimiters

Any response transmissions consist of one or two numbers followed by a response terminator. Where the response of the lock-in amplifier consists of two numbers in succession, they are separated by a byte called a delimiter. This delimiter can be any printing ASCII character and is selected by the DD command.

6.3.11 Compound Commands

A compound command consists of two or more simple commands separated by semicolons (ASCII 59) and terminated by a single command terminator. If any of the responses involve data transmissions, each one is followed by an output terminator.

6.3.12 Status Byte, Prompts and Overload Byte

An important feature of the GPIB standard is the serial poll operation by which a special byte, the status byte, may be read at any time from any instrument on the bus. This contains information which must be urgently conveyed from the instrument to the controller.

The function of the individual bits in the status byte is instrument dependent, apart

from bit 6 (the request service bit) whose function is defined by the standard.

In the model 5209, bits 0 and 7 signify "command complete" and "data available" respectively. In GPIB communications, the use of these bits can lead to a useful simplification of the control program by providing a response subroutine which is the same for all commands, whether or not they send a response over the bus. The subroutine should carry out the following sequence of events:

- 1) Send the command
- 2) Perform repeated serial poll operations in a loop until bit 0 (command complete) is zero. This implies that the command has been received by the instrument and is being processed. However, it is possible that if the command were a write-only command and a slow computer were being used then the instrument may actually clear and then reset bit 0 (i.e. actually complete the command) before the first serial poll operation were executed. Hence the loop must include the provision to timeout under these conditions; a value of 10 ms should be satisfactory in most cases.
- 3) If bit 0 clears, perform repeated serial polls testing both bit 0 and bit 7 (data available) and, if bit 7 is asserted then perform a read operation. This cycle (i.e. test bit 0 (command complete) and test bit 7 (data available)) should then continue until the lock-in amplifier asserts bit 0 to indicate that the command-response sequence is complete, so that the instrument will then be ready for the next command.

This procedure, although apparently complex, deals successfully with compound commands.

In RS232 communications, comparatively rapid access to the status byte is provided by the prompt character which is sent by the lock-in amplifier at the same time as bit 0 becomes asserted in the status byte. This character is sent out by the lock-in amplifier after each command response (whether or not the response includes a transmission over the interface) to indicate that the response is finished and the instrument is ready for a new command. The prompt takes one of two forms. If the command contained an error, either in syntax or by a command parameter being out of range, or alternatively if an overload or reference unlock is currently being reported by the front panel indicators, the prompt is ? (ASCII 63). Otherwise the prompt is * (ASCII 42).

These error conditions correspond to the assertion of bits 1, 2, 3 or 4 in the status byte. When the ? prompt is received by the computer, the ST command may be issued in order to discover which type of fault exists and to take appropriate action.

The prompts are a rapid way of checking on the instrument status and enable a convenient keyboard control system to be set up simply by attaching a standard terminal, or a simple computer-based terminal emulator, to the RS232 port.

Because of the limited number of bits in the status byte, it can indicate that an overload exists but cannot give more detail. An auxiliary byte, the overload byte returned by the N command, gives details of the location of the overload.

A summary of the bit assignments in the status byte and the overload byte is given below.

Bit	Status Byte	Overload Byte
0	command complete	not used
1	invalid command	current mode set to 10^8 A/V
2	command parameter error	current mode set to 10^6 A/V
3	reference unlock	not used
4	overload	output overload
5	new output values available after external trigger or auto function in progress	PSD overload
6	SRQ asserted	input overload
7	data available	reference unlock

Note that bit 5 is set when the instrument is in ADC external trigger mode and a trigger is received at the rear-panel **ADC EXT TRIG IN** connector, and is cleared when the command to read the output (i.e. OUT) is applied. It is also set while an auto-function is in progress.

6.3.13 Service Requests

The GPIB interface includes a line (pin 10 on the connector) called the SRQ (service request) line which is used by the instrument to signal to the controller that urgent attention is required. At the same time that the instrument asserts the SRQ line, it also asserts bit 6 in the status byte. The controller responds by executing a serial poll of all the instruments on the bus in turn and testing bit 6 of the status byte in order to discover which instrument was responsible for asserting the SRQ line. The status byte of that instrument is then further tested in order to discover the reason for the service request and to take appropriate action.

In the model 5209 the assertion of the SRQ line is under the control of a byte called the SRQ mask byte which can be set by the user with the MSK command. If any bit in the status byte becomes asserted, and the corresponding bit in the mask byte has a nonzero value, the SRQ line is automatically asserted. If the value of the mask byte is zero, the SRQ line is never asserted.

Hence, for example, if the SRQ mask byte is set to 16, a service request would be generated as soon as an overload occurred; if the SRQ mask byte were set to 0, then service requests would never be generated.

6.4 Command Descriptions

This section lists the commands in logical groups, so that, for example, all commands associated with setting controls affecting the signal channel are shown together. Appendix E gives the same list of commands but in alphabetical order.

6.4.01 Signal Channel

SEN [n] Full-scale sensitivity control
The value of parameter n sets or reads the full-scale sensitivity according to the following table:

n	full-scale sensitivity
0	100 nV
1	300 nV
2	1 μ V
3	3 μ V
4	10 μ V
5	30 μ V
6	100 μ V
7	300 μ V
8	1 mV
9	3 mV
10	10 mV
11	30 mV
12	100 mV
13	300 mV
14	1 V
15	3 V

AS Perform an Auto-Sensitivity operation
The instrument adjusts its full-scale sensitivity so that the output lies between 30 % and 100 % of full-scale.

G [n₁, [n₂]] Vernier Gain Control
The G command sets or reads the status and gain of the signal-channel gain vernier control. Parameter n₁ sets or reads the control status, with n₁ = 0 representing off and n₁ = 1 on. Parameter n₂ sets or reads the gain in the range 0 to 255. The actual gain achieved for a given value of n₂ depends on the set sensitivity range and may vary from unit to unit.

ANR Perform an Auto-Normalize Operation
The ANR command causes the vernier mode to be activated the sensitivity to be adjusted to achieve an output of 100% (full-scale).

The auto-normalize operation always begins with an auto-sensitivity function. If none of the sensitivity ranges yields an output between 30% and 110% of full scale, the sensitivity is set to one extreme or the other and normalization is not attempted.

AA Abandon auto-function
This command terminates any auto-function in progress, except the auto-measure function, when it should be sent twice.

ASM Perform an Auto-Measure operation
The instrument adjusts its full-scale sensitivity so that the output lies between 30 % and 100 % of full-scale, and then performs an auto-phase operation to maximize the

output.

6.4.02 Signal Channel Filters

FLT [n] Main filter operating mode
The value of parameter n sets or reads the signal-channel filter mode according to the following table:

- n mode
- 0 **FLAT** (no filter)
- 1 **NOTCH** (band-rejection filter)
- 2 **LP** (low-pass filter)
- 3 **BP** (band-pass filter)

ATC [n] Filter frequency tuning mode control
The value of parameter n sets or reads the filter frequency tuning mode according to the following table:

- n filter frequency tuning mode
- 0 manual (frequency set by front-panel keys or by the FF command)
- 1 automatic (filter frequency set to reference channel frequency)

FF [n_1, n_2] Filter frequency control
The value of parameter n_2 sets or reads the filter frequency band according to the following table:

- n_2 frequency band
- 0 0.5 Hz to 12 Hz
- 1 10 Hz to 120 Hz
- 2 100 Hz to 1200 Hz
- 3 1 kHz to 12 kHz
- 4 10 kHz to 120 kHz

The value of parameter n_1 sets or reads the frequency within each band in the range 100 to 1200, except in the bottom band ($n_2 = 0$) where the range is 50 to 1200

Hence, for example, to set the frequency to 1 kHz, send the commands FF 100 3 or FF 1000 2

ATS Auto-tune filter frequency
The ATS command causes the filter frequency to be tuned to the reference frequency, by setting the filter track mode on and then off.

AA Abandon auto-function
This command terminates any auto-function in progress, except the auto-measure function.

LF [n] Signal channel line frequency rejection filter control
The value of parameter n sets or reads the mode of the line frequency notch filter according to the following table:

n	selection
0	Off
1	Enable 100 or 120 Hz notch filter
2	Enable 50 or 60 Hz notch filter
3	Enable both filters

6.4.03 Reference Channel

IE [n] Reference channel source control (Internal/External)

The value of parameter n sets or reads the reference input mode according to the following table:

n	selection
0	EXT (AC IN or TTL IN inputs)
1	INT (internal)

F2F [n] Reference harmonic mode control

The value of parameter n sets or reads the reference frequency mode, according to the following table:

n	selection
0	Signal detection occurs at the applied reference frequency (internal or external)
1	Signal detection occurs at twice the applied reference frequency (internal or external)

P [n₁, n₂] Reference phase control

The parameters n₁ and n₂ set or read the reference channel phase shifter, as follows:-

Parameter n₁ sets or reads the phase quadrant according to the following table:

n ₁	quadrant
0	0° to 90°
1	90° to 180°
2	180° to 270°
3	270° to 360°

Parameter n₂ sets or reads the phase within each quadrant to any value between 0° and 100° in millidegrees, with a minimum resolution of 5 m°, i.e. n₂ can range from 0 to 100000.

AQN Auto-Phase (auto quadrature null)

The instrument adjusts the reference phase to maximize the X channel output and minimize the Y channel output signals.

AA Abandon auto-function

This command terminates any auto-function in progress, except the auto-measure function.

FRQ Reference frequency meter

If the lock-in amplifier is in the external reference source modes, the FRQ command

causes the lock-in amplifier to respond with 0 if the reference channel is unlocked, or with the reference input frequency if it is locked. If the lock-in amplifier is in the internal reference source mode, it responds with the frequency of the internal oscillator. In both cases the response is in mHz.

6.4.04 Signal Channel Output Filter

XDB [n] Output low-pass filter slope (roll-off) control

The value of parameter n sets or reads the slope of the output filters according to the following table:

n	slope
0	6dB/octave
1	12dB/octave

XTC [n] Filter time constant control

The value of parameter n sets or reads the time constant of the output according to the following table:

n	time constant
0	1 ms
1	3 ms
2	10 ms
3	30 ms
4	100 ms
5	300 ms
6	1 s
7	3 s
8	10 s
9	30 s
10	100 s
11	300 s
12	1 ks
13	3 ks

6.4.05 Signal Channel Output Amplifier

DR [n] Dynamic reserve control

The value of parameter n sets or reads the instrument's dynamic reserve, according to the following table:

n	selection
0	HI STAB (high stability setting)
1	NORM (normal setting)
2	HI RES (high dynamic reserve setting)

XOF [n₁ [n₂]] Output offset control

The value of parameter n₁ sets or reads the status and level of the output offset facility according to the following table:

- n_1 selection
 0 Disables offset facility
 1 Enables offset facility

The range of n_2 is ± 1500 corresponding to $\pm 150\%$ of the full-scale output.

AXO Auto-Offset

The output offset is turned on and set to levels giving zero output. Any changes in the input signal then appear as changes about zero in the output.

AA Abandon auto-function

This command terminates any auto-function in progress, except the auto-measure function.

EX [n] Output expansion control

The value of parameter n sets or reads the output expansion mode in accordance with the following table:

- n expand mode
 0 Off
 1 Expand output by $\times 10$.

6.4.06 Instrument Outputs

OUT Read output

The OUT command causes the lock-in amplifier to respond with the value indicated on the **OUTPUT** LCD and analog panel meter, as set by the **OUTPUT** group **DISPLAY/LIGHTS** control or the D2 command. The response range is ± 15000 , full-scale being ± 10000

***** Transfer command

This command establishes the high-speed transfer mode. When an * (ASCII 42) character is sent, without terminator, to the instrument, it will reply with the value of **SIGNAL** or **RATIO**, depending on the setting of the **OUTPUT** display selection, as set by the **DISPLAY/LIGHTS** control or the D2 command.

The response occurs as fast as possible and the instrument then waits for another *. If the computer processes the reply quickly and responds immediately with another *, then very rapid controlled data transfer is possible.

The first transfer takes a little longer than subsequent ones because some overhead time is required for the model 5209 to get into the high speed transfer mode. When in this mode, the front panel controls are inactive and display is not updated. In addition, auto-tracking of the reference channel frequency is also suspended, although the analog control loop will keep the instrument in lock for moderate (i.e. $< 10\%$) changes in reference frequency.

The mode is terminated by sending any command other than an *, when the instrument will exit the mode and process the new command.

NOTE: *A terminator is not required with this command, so check that the computer program does not automatically add carriage return or carriage return-line feed characters to the * command, since this will slow down communications.*

OUTFF [n] Continuous data output control.
When the OUTFF 1 command is applied, the model 5209 sends a continuous stream of output readings to the computer (equivalent to the response to the OUT command), at rates of up to 100 Hz. Each value is terminated by a carriage return character.

There are three methods for terminating the data stream, as follows:-

RS232 communications

Apply the command OUTFF 0

GPIB communications

Issue a GPIB SDC (selected device clear) command from the controller

Front-Panel

Press the **CONFIG** key twice.

NOTE: *Be sure that the controlling program can handle a data stream of this nature before issuing the OUTFF 1 command.*

6.4.07 Internal Oscillator

OA [n] Oscillator amplitude control
The value of parameter n sets or reads the oscillator amplitude. The range of n is 0 to 2000 representing 0 to 2 V rms, but the value 5000 may also be used, which corresponds to an output amplitude of 5.000 V rms.

OF [n₁ n₂] Oscillator frequency control
The value of parameter n₂ sets or reads the oscillator frequency band according to the following table:

n ₂	frequency band
0	0.5 Hz to 2 Hz
1	2.0 Hz to 20 Hz
2	20 Hz to 200 Hz
3	200 Hz to 2 kHz
4	2 kHz to 20 kHz
5	20 kHz to 120 kHz

The value of parameter n₁ sets or reads the frequency within each band in the range 2000 to 20000

Hence, for example, to set the frequency to 1 kHz, send the command OF 1000 3.

6.4.08 Auxiliary Outputs

DAC [n₁ [n₂]] Auxiliary DAC output control

The value of parameter n₂ sets or reads the voltage appearing at the rear panel **DAC AUX OUT** outputs, in the range -15000 to +15000, corresponding to voltages from -15.000 V to +15.000 V. The value of n₁ determines the output, **CH1** or **CH2**, that is set by the command.

6.4.09 Auxiliary Inputs

ADC n Read auxiliary analog to digital inputs

Reads the voltage appearing at the rear panel **ADC AUX INPUT CH1** (n = 1), **CH2** (n = 2), **CH3** (n = 3) or **CH4** (n = 4) inputs.

The response for ADC n is an integer in the range -15000 to +15000, corresponding to voltages from -15.000 V to +15.000 V.

TRIG [n] ADC trigger mode control

The value of parameter n sets or reads the trigger mode of the ADC converter used for converting both the output and the auxiliary ADC inputs according to the following table:

n trigger mode

0 Reference Trigger Mode

In this setting, the ADC is triggered synchronously with the reference frequency. The maximum conversion rate is nominally once every 5 ms (200 Hz), so that at low reference frequencies there will be one trigger per reference period. At higher reference frequencies there will be one trigger per some multiple of the reference period.

Each trigger results in the conversion of the output and one of the four **ADC AUX INPUTS**. Thus any given **ADC AUX INPUT** is converted once every four trigger cycles.

1 External Trigger Mode

In this setting the ADC is triggered once on each positive going TTL transition detected at rear-panel **ADC EXT TRIG IN** connector. If an applied trigger occurs before the converter has finished processing the previous trigger, it is ignored. On any given trigger, the output and all four of the **ADC AUX INPUTS** are converted.

2 Asynchronous Trigger Mode

In this setting the ADC is triggered asynchronously at 100 Hz. On any given trigger, the output and one of the four **ADC AUX INPUTS** are converted. Thus any given **ADC AUX INPUT** is converted once every four trigger cycles (i.e. at a 25 Hz rate).

4 Ratio Trigger Mode

In this setting, triggering is synchronous with the reference signal as for mode 0, but only the output and the **ADC AUX INPUT CH1** are converted. The

maximum conversion rate is nominally once every 5 ms (200 Hz), so that at low reference frequencies there will be one trigger per reference period. At higher reference frequencies there will be one trigger per some multiple of the reference period.

The advantage of this mode over the reference synchronous trigger mode (mode 0) is that the **ADC AUX INPUT CH1** input is converted at the same rate as the output, giving better results when the instrument is set to the ratio display mode.

NOTE: In the ratio trigger mode, the ADC AUX INPUT CH2, CH3 and CH4 inputs are never converted.

8 “8F” Trigger Mode

In this setting, at reference frequencies below 12 Hz, triggering is synchronous with the reference, but there are eight triggers per reference signal period. On any given trigger, the output and one of the four **ADC AUX INPUTS** is converted. Thus any given **ADC AUX INPUT** is converted once every four trigger cycles (i.e. twice per reference cycle). The eight output readings are digitally averaged and it is this averaged values that is displayed and made available for transfer to a computer.

At frequencies above 20 Hz, the trigger mode automatically changes to the asynchronous trigger mode, but 8F triggering is automatically restored if the frequency is subsequently drops to less than 20 Hz.

6.4.10 Computer Interfaces (RS232 and GPIB)

RS [n_1 [n_2]] Set or read RS232 interface communications settings

The value of parameter n_1 sets or reads the baud rate of the RS232 interface according to the following table:

n_1	baud rate (bits per second)
0	75
1	110
2	134.5
3	150
4	300
5	600
6	1200
7	2000
8	2400
9	4800
10	1800
11	9600
12	19200

The lowest five bits in parameter n_2 control the other RS232 parameters according to the following table:

bit number	bit negated	bit asserted
0	7 data bits	8 data bits
1	even parity	odd parity
2	1 parity bit	no parity bit
3	1 stop bit	2 stop bits
4	echo disabled	echo enabled

GP [n_1 n_2] Set/Read GPIB communications settings

The value of parameter n_1 sets or reads the GPIB address in the range 0 to 31

The value of parameter n_2 sets or reads the GPIB terminator and the test echo settings according to the following table:

n	terminator
0	[CR], test echo disabled
1	[CR], test echo enabled
2	[CR,LF], test echo disabled
3	[CR,LF], test echo enabled

In all cases the EIO line is asserted with the last byte of a response.

When the test echo is on, every character transmitted or received via the GPIB port is echoed to the RS232 port. This is provided solely as an aid to program development and should not be enabled during normal operation of the instrument.

DD [n] Define delimiter control

The value of parameter n , which can be set to 13 or 32 to 125, determines the ASCII value of the character sent by the lock-in amplifier to separate two numeric values in a two-value response, such as that generated by the OF (oscillator frequency) command.

ST Report status byte

Causes the lock-in amplifier to respond with the status byte, an integer between 0 and 255 which is the decimal equivalent of a binary number with the following bit-significance:

bit	significance
0	command complete
1	invalid command
2	command parameter error
3	reference unlock
4	overload
5	new output values available after external trigger
6	SRQ asserted
7	data available

NOTE: Unlike the GPIB serial poll, the ST command cannot be used to determine whether an auto-function is in progress (bit 5), since the ST command cannot be issued until the previous command which initiated the auto-function completes.

The ST command is not normally used in GPIB communications, where the status byte is accessed by performing a serial poll.

N Report overload byte
 Causes the lock-in amplifier to respond with the overload byte, an integer between 0 and 255 which is the decimal equivalent of a binary number with the following bit-significance:

bit	significance
0	not used
1	current mode set to 10^8 A/V
2	current mode set to 10^6 A/V
3	Not used
4	Output overload
5	PSD overload
bit	significance
6	input overload
7	reference unlock

MSK [n] Set/read service request mask byte
 The value of parameter n sets or reads the SRQ mask byte in the range 0 to 255

REMOTE [n] Remote only (front panel lockout) control
 The value of parameter n sets or reads the front-panel lock-out control, in accordance with the following table:

n	significance
0	Front panel keys active
1	Front panel keys locked-out, except for the LOCAL key. The instrument can only be controlled via the RS232 or the GPIB interfaces.

6.4.11 Instrument Identification

ID Identification
 Causes the lock-in amplifier to respond with the number 5209.

VER Report firmware version
 Causes the lock-in amplifier to respond with the firmware version number.

6.4.12 Front Panel

D1 [n] **TUNING** selection control
 The value of parameter n sets or reads the **TUNING** selection according to the following table:

n	selection
0	SET REF PH (Reference Phase)
1	SET OSC LVL (Oscillator Amplitude)
2	SET OSC F (Oscillator Frequency)
3	FIL FRQ (Filter Frequency)
4	REF F (Display Reference Frequency)

D2 [n] OUTPUT selection control

The value of parameter n sets or reads the **OUTPUT** selection, and the output appearing at the front-panel **OUT** analog output according to the following table:

n	selection	OUT output
0	% FS	Output
1	SIGNAL	Output
2	OFFSET	Output
3	NOISE	Noise output
4	RATIO	Ratio
5	LOG R	Log Ratio

The **OUT** output range is ± 10.000 V corresponding to full-scale, i.e. values of $\pm 100\%$ when in the **% FS** display setting. The noise output is 0 to $+10.000$ V, corresponding to 0 to 100% of the full-scale sensitivity.

DISP [n] Display update rate control

The value of parameter n sets the display update period from 0.1 seconds to 1.0 seconds in 0.1 second increments.

DM Digimeter mode control

The DM command is a toggle command which turns the digimeter display mode on or off each time it is used.

The output filters used in the model 5209 normally use analog techniques for time-constants of 3 s or shorter, with digital methods used at longer settings. When the digital filter is used, the analog panel meter (and **OUT** output) are driven by the output of a digital to analog converter.

When digimeter mode is turned on, the analog panel meter is driven by the output of the digital to analog converter at all time constant settings. The mode is primarily intended for use in the 8F trigger mode, and causes the reading on the analog meter to be averaged in the same way as that on the **OUTPUT** LCD.

NOTE: The digimeter mode is always turned OFF at power-up.

KP Keypress identifier

The KP command reads and resets the status of an internal flag that is set every time a front-panel key is pressed. If the flag is in the set state when the command is issued, the response is 1; if it is in the reset state, then the response is 0. The KP command always leaves the flag in the reset state.

LTS [n] Lights on/off control

The value of parameter n controls the front panel LEDs according to the following table:

n	selection
0	All lights off
1	Normal operation

6.4.13 Calibration

ADCAL Analog to digital converter calibration

The ADCAL command corrects for zero offset in the ADC converter. It should only be used when there is no signal input connected to the 5209.

6.5 Programming Examples

6.5.01 Introduction

This section gives some examples of the commands that need to be sent to the lock-in amplifier for typical experimental situations.

6.5.02 Converting Output Values to Voltages and Currents

The OUT instrument command which reports the output value generally does so with a number which represents the output as a proportion of the present full-scale sensitivity, where a response of “+10000” represents 100% of full-scale. If it is desired to know what this represents in terms volts or amps at the input, then the following procedure needs to be adopted:

- 1) Issue a N (overload status command). The response value should then be checked to see if bits 1 or 2 are asserted. The input mode in use can then be determined as follows:

Bit asserted	significance
1	Current input mode with a 10^8 A/V conversion setting
2	Current input mode with a 10^6 A/V conversion setting
Neither 1 or 2	Voltage input mode

- 2) Issue a SEN command to determine the present sensitivity setting. Let the response from this command be *senrange*code.
- 3) Determine the full-scale sensitivity range, *senrange*, either by use of a look-up table or by the following equation:-

$$senrange = (1 + (2 \times (senrange\ code \text{ MOD } 2))) \times 10^{(INT(\frac{senrange\ code}{2}) - 7)}$$

where $INT(x)$ represents a function returning the largest integer less than or equal to x , and $(senrange \text{ MOD } 2)$ is a function returning the remainder after dividing *senrange* by 2 (equivalent to logically ANDing *senrange*code with 1)

- 4) Issue the commands to report the required output. In the 5209 this requires that the **OUTPUT** LCD first be set to show the required value using the D2 command and then the OUT command be issued to actually report the output. The response to the OUT command will be a value between -15000 and +15000, corresponding to $\pm 150.00\%$ of the full-scale sensitivity. Let the reported value be *outputuncal*

- 5) The output can now be expressed in terms of volts or amps as *outputcalib* by the use of the following equations:-

If bits 1 and 2 of the response to N are zero:

$$\text{outputcalib} = \text{outputuncal} \times \text{senrange} \times 10^{-5} \text{ Volts}$$

If bit 1 of the response to N is asserted:

$$\text{outputcalib} = \text{outputuncal} \times \text{senrange} \times 10^{-13} \text{ Amps}$$

If bit 2 of the response to N is asserted:

$$\text{outputcalib} = \text{outputuncal} \times \text{senrange} \times 10^{-15} \text{ Amps}$$

NOTE: Remember that the full-scale sensitivity setting is potentially affected by the AS, ASM and SEN commands. Hence, unless it is certain that the setting has not changed, read both the output and the sensitivity setting and follow the above procedure for every output reading.

6.5.03 Basic Signal Recovery

In a typical simple experiment, the computer is used to set the instrument controls and then to record the chosen outputs, perhaps as a function of time. The commands to achieve this would therefore be similar to the following sequence:

IE 0	Set reference source to external input mode
LF 0	Turn off line frequency rejection filter
ASM	Auto-Measure
XDB 1	Set output filter slope to 12dB/octave
TC 5	Set time constant to 300ms, since previous ASM may have changed it
D2 0	Sets OUTPUT LCD to show the % FS output.

Then the outputs could be read as follows:

OUT	Reads output
FRQ	Reads reference frequency in millihertz

The controlling program would send a new output command each time a new reading were required. Note that a good "rule of thumb" with a 12dB/octave filter slope is to wait for a period of five time constants after the input signal has changed before recording a new value. Hence in a scanning type experiment, the program should issue the commands to whatever equipment causes the input signal to the lock-in amplifier to change, wait for a period of five time constants, and then record the required output.

6.5.04 Frequency Response Measurement

In this example, the lock in amplifier's internal oscillator output signal is fed via the filter stage under test back to the instrument's signal input. The oscillator frequency is stepped between a lower and an upper frequency and the signal magnitude and phase recorded. The commands to achieve this would therefore be similar to the following sequence:

IE 1	Set reference mode to internal
LF 0	Turn off line frequency rejection filter
OA 1000	Set oscillator amplitude to 1.0 V rms
OF 10000 2	Set oscillator frequency to 100 Hz (starting frequency)
SEN 14	Set sensitivity to 1 V full-scale
TC 3	Set time constant to 30 ms
AQN	Auto-Phase
D2 0	Sets OUTPUT LCD to show the % FS output.

The frequency sweep would be performed and the outputs recorded by sending the following commands from a FOR...NEXT program loop:

OF n ₁ n ₂	Set oscillator frequency to new value defined by n ₁ and n ₂
AQN	Auto-phase at the new frequency
	Software delay of 250ms (5 x 50ms) allowing output to stabilize
OUT	Read output - will correspond to signal magnitude since auto-phase has been executed
P	Read reference phase
FRQ	Read reference frequency in hertz. This would nominally be same as the oscillator frequency since the unit is operating in the internal reference mode, but due to oscillator frequency stability considerations, it is more accurate than the value set by the OF n ₁ n ₂ command.

Repeat these commands until the stop frequency is reached.

Specifications

Measurement Modes

% FS	Phase sensitive detector output expressed as a percentage of the present full-scale sensitivity setting
SIGNAL	Phase sensitive detector output expressed directly in terms of voltage at input to signal channel
NOISE	Noise in a bandwidth defined by the output filter time constant and slope controls and centered at the reference frequency expressed as a percentage of the present full-scale sensitivity setting
Harmonic	Fundamental (F) or 2F modes

Displays & Indicators

Two, 3½ -digit liquid crystal displays, analog center-zero panel meter and back-lit LED indicators show the settings of all the main instrument controls and outputs.

Signal Channel

Voltage Inputs

Modes	A only or Differential (A-B)
Full-scale Sensitivity	100 nV to 3 V rms in a 1-3-10 sequence
Impedance	100 MΩ // 30 pF
Maximum Input	± 100 V DC; 30 V AC pk-pk without damage, 10 V AC pk-pk without saturation
Voltage Noise	5 nV/√Hz at 1 kHz typ
CMRR	> 100 dB at 1 kHz degrading by 6 dB/octave
Frequency Response	0.5 Hz to 120 kHz
Grounding	BNC shields can be grounded or floated via 1 kΩ to ground

Current Input

Mode	10 ⁶ V/A or 10 ⁸ V/A
Full-scale Sensitivity	
10 ⁸ V/A	10 fA to 30 nA in a 1-3-10 sequence
10 ⁶ V/A	10 fA to 3 μA in a 1-3-10 sequence
Frequency Response	
10 ⁸ V/A	-3 dB at 330 Hz
10 ⁶ V/A	-3 dB at 60 kHz
Impedance	
10 ⁸ V/A	< 2.5 kΩ at 100 Hz
10 ⁶ V/A	< 250 Ω at 1 kHz

Maximum Input	15 mA continuous, 1 A momentary without damage. 10 μ A AC pk-pk without saturation on 10 ⁶ V/A; 100 nA AC pk-pk without saturation on 10 ⁸ V/A
Noise	
10 ⁸ V/A	13 fA/ $\sqrt{\text{Hz}}$ at 500 Hz
10 ⁶ V/A	130 fA/ $\sqrt{\text{Hz}}$ at 1 kHz
Grounding	BNC shield can be grounded or floated via 1 k Ω to ground
Line Notch Filter	> 34dB attenuation @ \pm 1% of 50 or 60 Hz and/or 100 or 120 Hz
Dynamic Reserve	130 dB max
Gain Accuracy	
Flat Mode	1% typical
Bandpass Mode	2% typical
Gain Stability	200 ppm/ $^{\circ}$ C typical

Reference Channel

TTL Input	
Frequency Range	0.5 Hz to 120 kHz
Analog Input	
Impedance	1 M Ω // 30 pF
Frequency Range	0.5 Hz to 120 kHz
Level	
Sinusoidal Input	1.0 V rms**
Squarewave Input	100 mV rms**
	**Note: Lower levels can be used with the analog input at the expense of increased phase errors.
Maximum input voltage	5.0 V rms
Phase	
Set Resolution	0.1 $^{\circ}$ (front-panel) or 0.005 $^{\circ}$ (computer command only) increments
Accuracy	\pm 1 $^{\circ}$ typical
Noise	0.005 $^{\circ}$ rms at 100 ms TC, 12 dB/octave
Orthogonality	
Above 5Hz	90 $^{\circ}$ \pm 0.5 $^{\circ}$
0.5Hz - 5Hz	90 $^{\circ}$ \pm 5 $^{\circ}$ max
Drift (Flat Mode)	< 0.05 $^{\circ}$ / $^{\circ}$ C
Lock Acquisition Time	2 cycles + 100 ms

Demodulator

Description	Switching type demodulators operating in either square wave or Walsh function modes.
Output Zero Stability	
High Dynamic Reserve	500 ppm/°C
Normal	50 ppm/°C
High Stability	5 ppm/°C
Harmonic Rejection	
Low-Pass	>80 dB at 1 kHz
Bandpass	>60 dB at 1 kHz
Time Constant	
Main output	1 ms to 3 ks in a 1-3-10 sequence
Roll-off	6 and 12 dB/octave
P.S.D. Monitor Output	100 μ s nominal
Roll-off	6 dB/octave only
Offset	Auto and Manual: ± 150 % FS

Oscillator

Frequency	
Range	0.5 Hz to 120 kHz
Setting Resolution	better than 1%
Absolute Accuracy	± 2 %
Distortion (THD)	0.5%
Amplitude	
Range	
Front panel	1 mV to 1.999 V
Computer Control	1 mV to 2.000 V and 5.000 V
Setting Resolution	
1 mV to 500 mV	1 mV
501 mV to 2 V	4 mV
Output	
Impedance	900 Ω

Auxiliary Inputs

AUX ADC INPUT CH1 - CH4	
Maximum Input	± 15 V
Resolution	1 mV
Input Impedance	1 M Ω // 30 pF
Sample Rate	
CH1 only	200 Hz max.

CH1 - CH4	50 Hz max.
Trigger Mode	Internal or External
Trigger input	TTL compatible

Outputs

OUT Analog Output

Function	Output, Noise, Ratio and Log Ratio.
Amplitude	±15 V (±10.0 V = ± full scale)
Impedance	1 kΩ

Signal Monitor

Amplitude	±10 V max
Impedance	1 kΩ

Aux D/A Outputs

Maximum Output	±15 V
Resolution	1 mV
Output Impedance	< 150 Ω

Reference Output

Waveform	0 to 5 V square wave
Impedance	TTL compatible

Power - Low Voltage

±15 V at 100 mA rear panel DIN connector for powering **SIGNAL RECOVERY** preamplifiers

Interfaces

RS232 and GPIB (IEEE-488). All settings can be adjusted from the front-panel

General

Power Requirements

Voltage	110/120/220/240 VAC
Frequency	50/60 Hz
Power	< 130 VA

Dimensions

Width	440 mm (17.25")
Depth	89 mm (3.5 ")
Height	
With feet	105 mm (4.1 ")
Without feet	89 mm (3.5 ")

Weight

9.1 kg (20 lbs)

All specifications subject to change without notification

B1 RS232 Connector Pinout

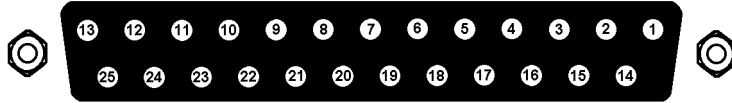

Figure B-1, RS232 Connector (Female)

Pin	Function	Description
1	Earth Ground	Ties the chassis of the model 5209 to that of the computer
2	Transmit Data	The 5209 transmits data on this line
3	Receive Data	The 5209 receives data on this line
4	Request to Send	This line is asserted by the 5209 when the input buffer is not full
5	Clear to Send	The computer should assert this line to allow the 5209 to transmit data. If left unconnected, the line assumes the asserted state allowing data transmission to proceed
7	Logic Ground	Data signals are referenced with respect to the voltage at this pin

All other pins are not connected

B2 Preampifier Power Connector Pinout

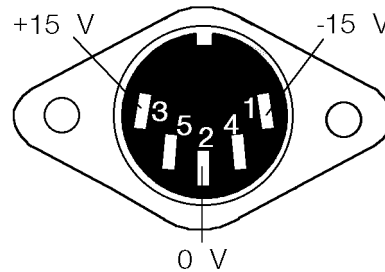

Figure B-2, Preampifier Power Connector

Pin	Function
1	-15 V
2	Ground
3	+15 V

Pins 4 and 5 are not connected. Shell is shield ground.

Demonstration Programs

C1 Simple Terminal Emulator

This is a short terminal emulator with minimal facilities, which will run on a PC-compatible computer in a Microsoft GWBASIC or QuickBASIC environment, or can be compiled with a suitable compiler.

```
10 'MINITERM 9-Feb-96
20 CLS : PRINT "Lockin RS232 parameters must be set to 9600 baud, 7 DATA bits, 1 stop
bit and even parity"
30 PRINT "Hit <ESC> key to exit"
40 OPEN "COM1:9600,E,7,1,CS,DS" FOR RANDOM AS #1
50 '.....
60 ON ERROR GOTO 180
70 '.....
100 WHILE (1)
110     B$ = INKEY$
120     IF B$ = CHR$(27) THEN CLOSE #1: ON ERROR GOTO 0: END
130     IF B$ <> "" THEN PRINT #1, B$;
140     LL% = LOC(1)
150     IF LL% > 0 THEN A$ = INPUT$(LL%, #1): PRINT A$;
160 WEND
170 '.....
180 PRINT "ERROR NO."; ERR: RESUME
```

C2 RS232 Control Program with Handshakes

RSCOM2.BAS is a user interface program which illustrates the principles of the echo handshake. The program will run on a PC-compatible computer either in a Microsoft GWBASIC or QuickBASIC environment, or in compiled form.

The subroutines in RSCOM2 are recommended for incorporation in the user's own programs.

```
10 'RSCOM2 9-Feb-96
20 CLS : PRINT "Lockin RS232 parameters must be set to 9600 baud, 7 data bits, 1 stop
bit, even parity"
30 OPEN "COM1:9600,E,7,1,CS,DS" FOR RANDOM AS #1
40 CR$ = CHR$(13) ' carriage return
50 '
60 '...main loop.....
70 WHILE 1 ' infinite loop
80     INPUT "command (00 to exit) "; B$ ' no commas are allowed in B$
90     IF B$ = "00" THEN END
100     B$ = B$ + CR$ ' append a carriage return
110     GOSUB 180 ' output the command B$
```

```

120     GOSUB 310: PRINT Z$;           ' read and display response
130     IF A$ = "?" THEN GOSUB 410: GOSUB 470 ' if "?" prompt fetch STATUS%
140                                           ' and display message
150 WEND                               ' return to start of loop
160 '
170 '
180 '...output the string B$.....
190 ON ERROR GOTO 510                   ' enable error trapping
200 IF LOC(1) > 0 THEN A$ = INPUT$(LOC(1), #1) ' clear input buffer
210 ON ERROR GOTO 0                     ' disable error trapping
220 FOR J1% = 1 TO LEN(B$)              ' LEN(B$) is number of bytes
230     C$ = MID$(B$, J1%, 1): PRINT #1, C$; ' send byte
240     WHILE LOC(1) = 0: WEND          ' wait for byte in input buffer
250     A$ = INPUT$(1, #1)              ' read input buffer
260     IF A$ <> C$ THEN PRINT "handshake error" ' input byte should be echo
270 NEXT J1%                            ' next byte to be sent or
280 RETURN                              ' return if no more bytes
290 '
300 '
310 '....read response.....
320 A$ = "": Z$ = ""
330 WHILE (A$ <> "*" AND A$ <> "?")     ' read until prompt received
340     Z$ = Z$ + A$                    ' append next byte to string
350     WHILE LOC(1) = 0: WEND          ' wait for byte in input buffer
360     A$ = INPUT$(1, #1)              ' read byte from buffer
370 WEND                                ' next byte to be read
380 RETURN                              ' return if it is a prompt
390 '
400 '
410 '....fetch status byte.....
420 B$ = "ST" + CR$                    ' "ST" is the status command
430 GOSUB 180                           ' output the command
440 GOSUB 310                            ' read response into Z$
450 STATUS% = VAL(Z$)                   ' convert to integer
460 RETURN
470 '....instrument error message.....
480 PRINT "Error prompt, status byte = "; STATUS% ' bits are defined in manual
490 PRINT
500 RETURN
510 '....I/O error routine.....
520 RESUME

```

C3 GPIB User Interface Program

GPCOM.BAS is a user interface program which illustrates the principles of the use of the serial poll status byte to coordinate the command and data transfer.

The program runs under Microsoft GWBASIC or QuickBASIC on a PC-compatible computer fitted with a National Instruments IEEE488 interface card and the GPIB.COM software installed in the CONFIG.SYS file. The program BIB.M, and the first three lines of GPCOM, are supplied by the card manufacturer and must be the correct version for the particular version of the interface card in use. The interface card may be set up, using the program IBCONF.EXE, to set EOI with the last byte of Write in which case no terminator is required. (Read operations are automatically terminated on EOI which is always sent by the lock-in amplifier). Normally, the options called 'high-speed timing', 'interrupt jumper setting', and 'DMA channel' should all be disabled.

The principles of using the Serial Poll Status Byte to control data transfer, as implemented in the main loop of GPCOM, are recommended for incorporation in the user's own programs.

```

10 'GPCOM 9-Feb-96
20 '....the following three lines and BIB.M are supplied by the.....
30 '....manufacturer of the GPIB card, must be correct version.....
40 CLEAR , 60000!: IBINIT1 = 60000!: IBINIT2 = IBINIT1 + 3: BLOAD "BIB.M", IBINIT1
50 CALL IBINIT1(IBFIND, IBTRG, IBCLR, IBPCT, IBSIC, IBLOC, IBPPC, IBBNA, IBONL, IBRSC,
IBSRE, IBRSV, IBPAD, IBSAD, IBIST, IBDMA, IBEOS, IBTMO, IBEOT, IBRDF, IBWRTF, IBTRAP)
60 CALL IBINIT2(IBGTS, IBCAC, IBWAIT, IBPOKE, IBWRT, IBWRTA, IBCMD, IBCMDA, IBRD, IBRDA,
IBSTOP, IBRPP, IBRSP, IBDIAG, IBXTRC, IBRDI, IBWRTI, IBRDIA, IBWRTIA, IBSTA%, IBERR%,
IBCNT%)
70 '.....
80 CLS : PRINT "DEVICE MUST BE SET TO CR TERMINATOR"
90 '....assign access code to interface board.....
100 BDNAM$ = "GPIB0"
110 CALL IBFIND(BDNAM$, GPIB0%)
120 IF GPIB0% < 0 THEN PRINT "board assignment error": END
130 '....send INTERFACE CLEAR.....
140 CALL IBSIC(GPIB0%)
150 '....set bus address, assign access code to device.....
160 SUCCESS% = 0
170 WHILE SUCCESS% = 0
180     INPUT "BUS ADDRESS "; A%
190     DEVNAM$ = "DEV" + RIGHT$(STR$(A%), LEN(STR$(A%)) - 1)
200     CALL IBFIND(DEVNAM$, DEV%)           ' assign access code
210     IF DEV% < 0 THEN PRINT "device assignment error": END
220     A$ = CHR$(13): GOSUB 480             ' test: write <CR> to bus
230     IF IBSTA% > 0 THEN SUCCESS% = 1
240     IF (IBSTA% < 0 AND IBERR% = 2) THEN BEEP: PRINT "NO DEVICE AT THAT ADDRESS ";
250 WEND
260 '....send SELECTED DEVICE CLEAR.....
270 CALL IBCLR(DEV%)

```

```

280 '....set timeout to 1 second.....
290 V% = 11: CALL IBTMO(DEV%, V%)
300 '....set status print flag.....
310 INPUT "Display status byte y/n "; R$
320 IF R$ = "Y" OR R$ = "y" THEN DS% = 1 ELSE DS% = 0
330 '....main loop.....
340 WHILE 1                                ' infinite loop
350     INPUT "command (00 to exit) "; A$
360     IF A$ = "00" THEN END
370     A$ = A$ ' CHR$(13)                    ' terminator is <CR>
380     GOSUB 480                            ' write A$ to bus
390     S% = 0                               ' initialize S%
400     WHILE (S% AND 1) = 0                 ' while command not complete
410         GOSUB 530                       ' serial poll, returns S%
420         IF DS% THEN PRINT "S%= "; S%
430         IF (S% AND 128) THEN GOSUB 500: PRINT B$ ' read bus into B$ and print
440     WEND
445     IF (S% AND 4) THEN PRINT "parameter error"
450     IF (S% AND 2) THEN PRINT "invalid command"
460 WEND
470 '....end of main loop.....
480 '....write string to bus.....
490 CALL IBWRT(DEV%, A$): RETURN
500 '....read string from bus.....
510 B$ = SPACE$(32)                          ' B$ is buffer
520 CALL IBRD(DEV%, B$): RETURN
530 '.....serial poll.....
540 CALL IBRSP(DEV%, S%): RETURN

```

Cable Diagrams

D1 RS232 Cable Diagrams

Users who choose to use the RS232 interface to connect the model 5209 lock-in amplifier to a standard serial port on a computer will need to use one of two types of cable. The only difference between them is the number of pins used on the connector which goes to the computer. One has 9 pins and the other 25; both are null-modem (also called modem eliminator) cables in that some of the pins are cross-connected.

Users with reasonable practical skills can easily assemble the required cables from parts which are widely available through computer stores and electronics components suppliers. The required interconnections are given in figures D-1 and D-2

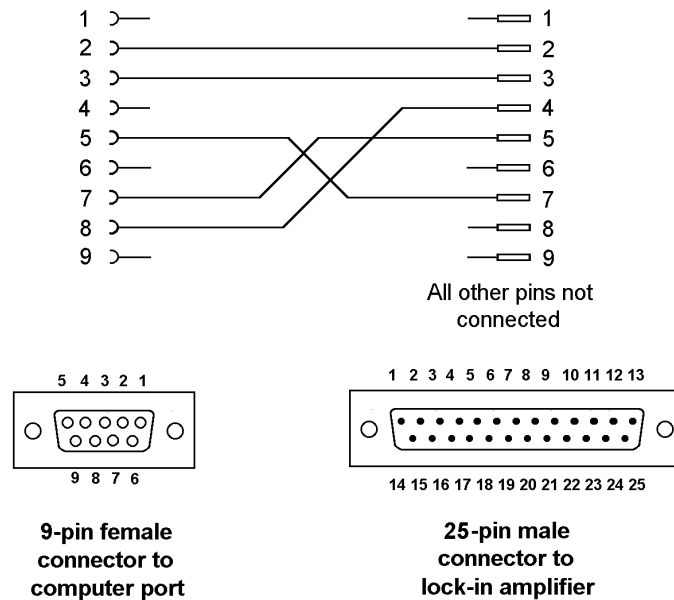

Figure D-1, Interconnecting RS232 Cable Wiring Diagram

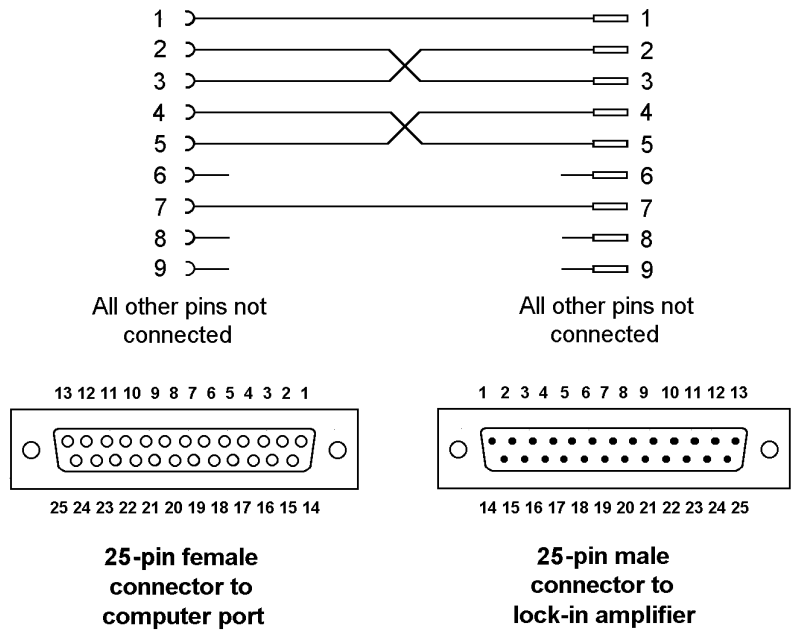

Figure D-2, Interconnecting RS232 Cable Wiring Diagram

Alphabetical Listing of Commands

* Transfer command

This command establishes the high-speed transfer mode. When an * (ASCII 42) character is sent, without terminator, to the instrument, it will reply with the value of **SIGNAL** or **RATIO**, depending on the setting of the **OUTPUT** display selection, as set by the **DISPLAY/LIGHTS** control or the D2 command.

The response occurs as fast as possible and the instrument then waits for another *. If the computer processes the reply quickly and responds immediately with another *, then very rapid controlled data transfer is possible.

The first transfer takes a little longer than subsequent ones because some overhead time is required for the model 5209 to get into the high speed transfer mode. When in this mode, the front panel controls are inactive and display is not updated. In addition, auto-tracking of the reference channel frequency is also suspended, although the analog control loop will keep the instrument in lock for moderate (i.e. < 10%) changes in reference frequency.

The mode is terminated by sending any command other than an *, when the instrument will exit the mode and process the new command.

NOTE: A terminator is not required with this command, so check that the computer program does not automatically add carriage return or carriage return-line feed characters to the * command, since this will slow down communications.

AA Abandon auto-function

This command terminates any auto-function in progress, except the auto-measure function, when it should be applied twice.

ADC n Read auxiliary analog to digital inputs

Reads the voltage appearing at the rear panel **ADC AUX INPUT CH1** (n = 1), **CH2** (n = 2), **CH3** (n = 3) or **CH4** (n = 4) inputs.

The response for ADC n is an integer in the range -15000 to +15000, corresponding to voltages from -15.000 V to +15.000 V.

ADCAL Analog to digital converter calibration.

The ADCAL command corrects for zero offset in the ADC converter. It should only be used when there is no signal input connected to the 5209.

ANR Perform an Auto-Normalize Operation

The ANR command causes the vernier mode to be activated the sensitivity to be adjusted to achieve an output of 100% (full-scale).

The auto-normalize operation always begins with an auto-sensitivity function. If none of the sensitivity ranges yields an output between 30% and 110% of full scale, the

sensitivity is set to one extreme or the other and normalization is not attempted.

- AQN** Auto-Phase (auto quadrature null)
The instrument adjusts the reference phase to maximize the output.
- AS** Perform an Auto-Sensitivity operation
The instrument adjusts its full-scale sensitivity so that the output lies between 30 % and 100 % of full-scale.
- ASM** Perform an Auto-Measure operation
The instrument adjusts its full-scale sensitivity so that the output lies between 30 % and 100 % of full-scale, and then performs an auto-phase operation to maximize the output.
- ATC [n]** Filter frequency tuning mode control
The value of parameter n sets or reads the filter frequency tuning mode according to the following table:
- | | |
|---|---|
| n | filter frequency tuning mode |
| 0 | manual (frequency set by front-panel keys or by FF command) |
| 1 | automatic (filter frequency set to reference channel frequency) |
- ATS** Auto-tune filter frequency
The ATS command causes the filter frequency to be tuned to the reference frequency, by setting the filter track mode on and then off.
- AXO** Auto-Offset
The output offset is turned on and set to a level giving zero output. Any changes in the input signal then appear as changes about zero in the output.
- D1 [n]** Display 1 selection control
The value of parameter n sets or reads the Display 1 selection according to the following table:
- | | |
|---|--|
| n | selection |
| 0 | SET REF PH (Reference Phase) |
| 1 | SET OSC LVL (Oscillator Amplitude) |
| 2 | SET OSC F (Oscillator Frequency) |
| 3 | FIL FRQ (Filter Frequency) |
| 4 | REF F (Display Reference Frequency) |
- D2 [n]** **OUTPUT** selection control
The value of parameter n sets or reads the **OUTPUT** selection, and the output appearing at the front-panel **OUT** analog output according to the following table:

n	selection	OUT output
0	% FS	Output
1	SIGNAL	Output
2	OFFSET	Output
3	NOISE	Noise output
4	RATIO	Ratio
5	LOG R	Log Ratio

The **OUT** output range is ± 10.000 V corresponding to full-scale, i.e. values of $\pm 100\%$ when in the **% FS** display setting. The noise output is 0 to $+10.000$ V, corresponding to 0 to 100% of the full-scale sensitivity.

DAC [n_1 [n_2]] Auxiliary DAC output control

The value of parameter n_2 sets or reads the voltage appearing at the rear panel **DAC AUX OUT** outputs, in the range -15000 to $+15000$, corresponding to voltages from -15.000 V to $+15.000$ V. The value of n_1 determines the output, **CH1** or **CH2**, that is set by the command.

DD [n] Define delimiter control

The value of parameter n , which can be set to 13 or 32 to 125, determines the ASCII value of the character sent by the lock-in amplifier to separate two numeric values in a two-value response, such as that generated by the OF (oscillator frequency) command.

DISP [n] Display update rate control

The value of parameter n sets the display update period from 0.1 seconds to 1.0 seconds in 0.1 second increments.

DM Digimeter mode control

The DM command is a toggle command which turns the digimeter display mode on or off each time it is used.

The output filters used in the model 5209 normally use analog techniques for time-constants of 3 s or shorter, with digital methods used at longer settings. When the digital filter is used, the analog panel meter (and **CH1** and **CH2** outputs) are driven by the output of a digital to analog converter.

When digimeter mode is turned on, the analog panel meter is driven by the output of the digital to analog converter at all time constant settings. The mode is primarily intended for use in the 8F trigger mode, and causes the reading on the analog meter to be averaged in the same way as that on the **DISPLAY 1** LCD.

NOTE: The digimeter mode is always turned OFF at power-up.

DR [n] Dynamic reserve control

The value of parameter n sets or reads the instrument's dynamic reserve, according to the following table:

- n selection
- 0 **HI STAB** (high stability setting)
- 1 **NORM** (normal setting)
- 2 **HI RES** (high dynamic reserve setting)

EX [n] Output expansion control

The value of parameter n sets or reads the output expansion mode in accordance with the following table:

- n expand mode
- 0 Off
- 1 Expand output by $\times 10$.

F2F [n] Reference harmonic mode control

The value of parameter n sets or reads the reference frequency mode, according to the following table:

- n selection
- 0 Signal detection occurs at the applied reference frequency (Internal or external)
- 1 Signal detection occurs at twice the applied reference frequency (Internal or external)

FF [n₁, n₂] Filter frequency control

The value of parameter n₂ sets or reads the filter frequency band according to the following table:

- n₂ frequency band
- 0 0.5 Hz to 12 Hz
- 1 10 Hz to 120 Hz
- 2 100 Hz to 1200 Hz
- 3 1 kHz to 12 kHz
- 4 10 kHz to 120 kHz

The value of parameter n₁ sets or reads the frequency within each band in the range 100 to 1200, except in the bottom band (n₂ = 0) where the range is 50 to 1200

Hence, for example, to set the frequency to 1 kHz, send the commands FF 100 3 or FF 1000 2

FLT [n] Main filter operating mode

The value of parameter n sets or reads the signal-channel filter mode according to the following table:

- n mode
- 0 **FLAT** (no filter)
- 1 **NOTCH** (band-rejection filter)
- 2 **LP** (low-pass filter)
- 3 **BP** (band-pass filter)

- FRQ** Reference frequency meter
If the lock-in amplifier is in the external reference source modes, the FRQ command causes the lock-in amplifier to respond with 0 if the reference channel is unlocked, or with the reference input frequency if it is locked. If the lock-in amplifier is in the internal reference source mode, it responds with the frequency of the internal oscillator. In both cases the response is in mHz.
- G [n₁, [n₂]]** Vernier Gain Control
The G command sets or reads the status and gain of the signal-channel gain vernier control. Parameter n₁ sets or reads the control status, with n₁ = 0 representing off and n₁ = 1 on. Parameter n₂ sets or reads the gain in the range 0 to 255. The actual gain achieved for a given value of n₂ depends on the set sensitivity range and may vary from unit to unit.
- GP [n₁ n₂]** Set/Read GPIB communications settings
The value of parameter n₁ sets or reads the GPIB address in the range 0 to 31

The value of parameter n₂ sets or reads the GPIB terminator and the test echo settings according to the following table:
- | | |
|---|-----------------------------|
| n | terminator |
| 0 | [CR], test echo disabled |
| 1 | [CR], test echo enabled |
| 2 | [CR,LF], test echo disabled |
| 3 | [CR,LF], test echo enabled |
- In all cases the EIO line is asserted with the last byte of a response.
- When the test echo is on, every character transmitted or received via the GPIB port is echoed to the RS232 port. This is provided solely as an aid to program development and should not be enabled during normal operation of the instrument.
- ID** Identification
Causes the lock-in amplifier to respond with the number 5209.
- IE [n]** Reference channel source control (Internal/External)
The value of parameter n sets or reads the reference input mode according to the following table:
- | | |
|---|---|
| n | selection |
| 0 | EXT (AC IN or TTL IN inputs) |
| 1 | INT (internal) |
- KP** Keypress identifier
The KP command reads and resets the status of an internal flag that is set every time a front-panel key is pressed. If the flag is in the set state when the command is issued, the response is 1; if it is in the reset state, then the response is 0. The KP command always leaves the flag in the reset state.

LF [n] Signal channel line frequency rejection filter control
The value of parameter n sets or reads the mode of the line frequency notch filter according to the following table:

- | | |
|---|-----------------------------------|
| n | selection |
| 0 | Off |
| 1 | Enable 100 or 120 Hz notch filter |
| 2 | Enable 50 or 60 Hz notch filter |
| 3 | Enable both filters |

LTS [n] Lights on/off control
The value of parameter n controls the front panel LEDs according to the following table:

- | | |
|---|------------------|
| n | selection |
| 0 | All lights off |
| 1 | Normal operation |

MSK [n] Set/read service request mask byte
The value of parameter n sets or reads the SRQ mask byte in the range 0 to 255

N Report overload byte
Causes the lock-in amplifier to respond with the overload byte, an integer between 0 and 255 which is the decimal equivalent of a binary number with the following bit-significance:.

- | | |
|-----|--------------------------------|
| bit | significance |
| 0 | not used |
| 1 | current mode set to 10^8 A/V |
| 2 | current mode set to 10^6 A/V |
| 3 | not used |
| 4 | output overload |
| 5 | PSD overload |
| 6 | input overload |
| 7 | reference unlock |

OA [n] Oscillator amplitude control
The value of parameter n sets or reads the oscillator amplitude. The range of n is 0 to 2000 representing 0 to 2 V rms, but the value 5000 may also be used, which corresponds to an output amplitude of 5.000 V rms.

OF [n₁, n₂] Oscillator frequency control
The value of parameter n₂ sets or reads the oscillator frequency band according to the following table:

n_2	frequency band
0	0.5 Hz to 2 Hz
1	2.0 Hz to 20 Hz
2	20 Hz to 200 Hz
3	200 Hz to 2 kHz
4	2 kHz to 20 kHz
5	20 kHz to 120 kHz

The value of parameter n_1 sets or reads the frequency within each band in the range 2000 to 20000

Hence, for example, to set the frequency to 1 kHz, send the command OF 1000 3

OUT Read output
 The OUT command causes the lock-in amplifier to respond with the value indicated on the **OUTPUT** LCD and analog panel meter, as set by the **OUTPUT** group **DISPLAY/LIGHTS** control or the D2 command. The response range is ± 15000 , full-scale being ± 10000

OUTFF [n] Continuous data output control.
 When the OUTFF 1 command is applied, the model 5209 sends a continuous stream of output readings to the computer (equivalent to the response to the OUT command), at rates of up to 100 Hz. Each value is terminated by a carriage return character.

There are three methods for terminating the data stream, as follows:-

RS232 communications

Apply the command OUTFF 0

GPIB communications

Issue a GPIB SDC (selected device clear) command from the controller

Front-Panel

Press the **CONFIG** key twice.

NOTE: Be sure that the controlling program can handle a data stream of this nature before issuing the OUTFF 1 command.

P [n_1, n_2] Reference phase control
 The parameters n_1 and n_2 set or read the reference channel phase shifter, as follows:-

Parameter n_1 sets or reads the phase quadrant according to the following table:

n_1	quadrant
0	0° to 90°
1	90° to 180°
2	180° to 270°
3	270° to 360°

Parameter n_2 sets or reads the phase within each quadrant to any value between 0° and 100° in millidegrees, with a minimum resolution of 5 m° , i.e. n_2 can range from 0 to 100000.

REMOTE [n] Remote only (front panel lockout) control
 The value of parameter n sets or reads the front-panel lock-out control, in accordance with the following table:

- n significance
- 0 Front panel keys active
- 1 Front panel keys locked-out, except for the **LOCAL** key. The instrument can only be controlled via the RS232 or the GPIB interfaces.

RS [n₁ [n₂]] Set or read RS232 interface communications settings
 The value of parameter n_1 sets or reads the baud rate of the RS232 interface according to the following table:

- n_1 baud rate (bits per second)
- 0 75
- 1 110
- 2 134.5
- 3 150
- 4 300
- 5 600
- 6 1200
- 7 2000
- 8 2400
- 9 4800
- 10 1800
- 11 9600
- 12 19200

The lowest five bits in parameter n_2 control the other RS232 parameters according to the following table:

bit number	bit negated	bit asserted
0	7 data bits	8 data bits
1	even parity	odd parity
2	1 parity bit	no parity bit
3	1 stop bit	2 stop bits
4	echo disabled	echo enabled

SEN [n] Full-scale sensitivity control
 The value of parameter n sets or reads the full-scale sensitivity according to the following table:

n	full-scale sensitivity
0	100 nV
1	300 nV
2	1 μ V
3	3 μ V
4	10 μ V
5	30 μ V
6	100 μ V
7	300 μ V
8	1 mV
9	3 mV
10	10 mV
11	30 mV
12	100 mV
13	300 mV
14	1 V
15	3 V

ST Report status byte

Causes the lock-in amplifier to respond with the status byte, an integer between 0 and 255 which is the decimal equivalent of a binary number with the following bit-significance:

bit	significance
0	command complete
1	invalid command
2	command parameter error
3	reference unlock
4	overload
5	new output values available after external trigger
6	SRQ asserted
7	data available

NOTE: Unlike the GPIB serial poll, the ST command cannot be used to determine whether an auto-function is in progress (bit 5), since the ST command cannot be issued until the previous command which initiated the auto-function completes.

The ST command is not normally used in GPIB communications, where the status byte is accessed by performing a serial poll.

TRIG [n] ADC trigger mode control

The value of parameter n sets or reads the trigger mode of the ADC converter used for converting both the output and the auxiliary ADC inputs according to the following table:

n	trigger mode
0	Reference Trigger Mode

In this setting, the ADC is triggered synchronously with the reference frequency. The maximum conversion rate is nominally once every 5 ms (200 Hz), so that at low reference frequencies there will be one trigger per reference period. At higher reference frequencies there will be one trigger per some multiple of the reference

period.

Each trigger results in the conversion of the output and one of the four **ADC AUX INPUTS**. Thus any given **ADC AUX INPUT** is converted once every four trigger cycles.

1 External Trigger Mode

In this setting the ADC is triggered once on each positive going TTL transition detected at rear-panel **ADC EXT TRIG IN** connector. If an applied trigger occurs before the converter has finished processing the previous trigger, it is ignored. On any given trigger, the output and all four of the **ADC AUX INPUTS** are converted.

2 Asynchronous Trigger Mode

In this setting the ADC is triggered asynchronously at 100 Hz. On any given trigger, the output and one of the four **ADC AUX INPUTS** are converted. Thus any given **ADC AUX INPUT** is converted once every four trigger cycles (i.e. at a 25 Hz rate).

4 Ratio Trigger Mode

In this setting, triggering is synchronous with the reference signal as for mode 0, but only the output and the **ADC AUX INPUT CH1** are converted. The maximum conversion rate is nominally once every 5 ms (200 Hz), so that at low reference frequencies there will be one trigger per reference period. At higher reference frequencies there will be one trigger per some multiple of the reference period.

The advantage of this mode over the reference synchronous trigger mode (mode 0) is that the **ADC AUX INPUT CH1** input is converted at the same rate as the output, giving better results when the instrument is set to the ratio display mode.

NOTE: In the ratio trigger mode, the ADC AUX INPUT CH2, CH3 and CH4 inputs are never converted.

8 “8F” Trigger Mode

In this setting, at reference frequencies below 12 Hz, triggering is synchronous with the reference, but there are eight triggers per reference signal period. On any given trigger, the output and one of the four **ADC AUX INPUTS** is converted. Thus any given **ADC AUX INPUT** is converted once every four trigger cycles (i.e. twice per reference cycle). The eight output readings are digitally averaged and it is this averaged values that is displayed and made available for transfer to a computer.

At frequencies above 20 Hz, the trigger mode automatically changes to the asynchronous trigger mode, but 8F triggering is automatically restored if the frequency is subsequently drops to less than 20 Hz.

VER Report firmware version

Causes the lock-in amplifier to respond with the firmware version number.

XDB [n] Output low-pass filter slope (roll-off) control

The value of parameter n sets or reads the slope of the output filters according to the following table:

n	slope
0	6dB/octave
1	12dB/octave

XOF [n_1 [n_2]] output offset control

The value of parameter n_1 sets or reads the status and level of the X offset facility according to the following table:

n_1	selection
0	Disables offset facility
1	Enables offset facility

The range of n_2 is ± 1500 corresponding to $\pm 150\%$ of the full-scale output.

XTC [n] Filter time constant control

The value of parameter n sets or reads the time constant of the output according to the following table:

n	time constant
0	1 ms
1	3 ms
2	10 ms
3	30 ms
4	100 ms
5	300 ms
6	1 s
7	3 s
8	10 s
9	30 s
10	100 s
11	300 s
12	1 ks
13	3 ks

- * command 6-13, E-1
- +90° key 5-8
- 10⁶ V/A key 5-2
- 10⁸ V/A key 5-2
- 2F key 5-13
- A key 5-2
- AA command 6-9, 6-10, 6-11, 6-13, E-1
- A-B key 5-2
- AC IN connector 4-2, 5-13
- Accuracy 3-22
- ACTIVE indicator 5-21
- ADC
 - auxiliary inputs 3-19
 - overview 3-15
 - trigger input 4-6
 - trigger mode control 5-11
 - trigger modes described 3-15
- ADC AUX INPUT connectors 4-6
- ADC EXT TRIG IN connector 4-6
- ADC n command 6-15, E-1
- ADCAL command 6-20, E-1
- Analog panel meter 3-18, 4-4, 5-12
- ANR command 6-9, E-1
- AQN command 6-11, E-2
- AS command 6-9, E-2
- ASM command 6-9, E-2
- ATC [n] command 6-10, E-2
- ATS command 6-10, E-2
- Auto functions
 - Auto-Measure 3-21, 5-10
 - Auto-Normalise 3-22, 5-3, 5-9
 - Auto-Offset 3-21, 5-10, 5-15
 - Auto-Phase 3-20, 5-10
 - Auto-Sensitivity 3-20, 5-2, 5-9
 - Auto-Tune 3-22, 5-9
 - introduction 3-20
- AUTO key 5-9
- Automatic ADC converter correction 6-1, 6-20
- AXO command 6-13, E-2
- Block diagram 3-2
- Commands
 - compound commands 6-6
 - delimiters 6-6
 - for auxiliary inputs 6-15
 - for auxiliary outputs 6-15
 - for calibration 6-20
 - for computer interfaces 6-16
 - for front panel control 6-18
 - for instrument identification 6-18
 - for instrument outputs 6-13
 - for internal oscillator 6-14
 - for reference channel 6-11
 - for signal channel 6-9
 - for signal channel filters 6-10
 - for signal channel output amplifier 6-12
 - for signal channel output filter 6-12
 - format 6-6
- Common mode rejection ratio (CMRR) 3-3
- Computer operation
 - introduction 6-1
 - sample programs 6-20
- CONFIG key 5-22
- Converting outputs to voltages and currents 6-20
- D1 [n] command 6-18, E-2
- D2 [n] command 6-19, E-2
- DAC
 - auxiliary outputs 3-19
 - DAC AUX OUT CH 1 and CH 2 connectors 4-5
- DAC [n₁ [n₂]] command 6-15, E-3
- DD [n] command 6-17, E-3
- Delimiters 6-6
- Demodulators
 - overview 3-9
 - squarewave mode 3-9
 - Walsh mode 3-9
- Differential voltage input mode 3-3
- Digimeter mode control 5-15
- DISP [n] command 6-19, E-3
- DISPLAY/LIGHTS key 5-16
- DM command 6-19, E-3
- DR [n] command 6-12, E-3
- DYN RES/GPIB key 5-15
- Dynamic reserve
 - demodulator reserve 3-13
 - filter reserve 3-14
 - overview 3-13
- ENBW (Equivalent noise bandwidth) 3-17
- EX [n] command 6-13, E-4
- EXPAND key 5-16
- F2F [n] command 6-11, E-4
- FF [n₁, n₂] command 6-10, E-4
- FLOAT/GROUND key 5-2

- FLT [n] command 6-10, E-4
- Front Panel
 - layout 4-1
 - lights on/off control 5-24
 - operation 5-1
- FRQ command 6-11, E-5
- Fuses
 - line 2-2
 - rating 2-3
- G [n₁, [n₂]] command 6-9, E-5
- GP [n₁, n₂] command 6-17, E-5
- GPIO interface
 - address control 5-24
 - connector 4-5
 - general features 6-3
 - handshaking and echoes 6-4
 - service requests 6-8
 - status byte 6-6
 - terminator control 5-24
 - terminators 6-5
 - test echo control 5-24
- ID command 6-18, E-5
- IE [n] command 6-11, E-5
- Initial checks 2-3
- Input
 - connector selection 3-2, 4-1
 - connector shell ground/float 3-3
 - current/voltage mode selection 3-3
- Inspection 2-1
- Installation 2-1
- INT key 5-12
- Key specifications 1-3
- KP command 6-19, E-5
- LCD displays 4-4
- LF [n] command 6-10, E-6
- Line cord 2-2
- Line frequency rejection filter 3-3
- Line power input assembly 4-5
- LINE REJECT key 5-6
- Line voltage selection 2-2
- LOCAL key 5-21
- Log ratio output 5-20
- LTS [n] command 6-19, E-6
- Main filter
 - Bandpass mode 3-4, 5-4
 - Flat mode 3-4, 5-4
 - introduction 3-4
 - Low-pass mode 3-4, 5-4
 - Notch mode 3-4, 5-5
- MEASURE key 5-10
- MODE key 5-4
- MSK [n] command 6-18, E-6
- N command 6-18, E-6
- Noise measurements 3-16
- OA [n] command 6-14, E-6
- OF [n₁, n₂] command 6-14, E-6
- OFFSET/AUTO key 5-15
- Operating environment 2-1
- Oscillator
 - +5V rms output setting 6-1
 - amplitude range 3-7
 - frequency range 3-7
 - OSC OUT connector 4-2, 5-13
 - output impedance 3-7
 - overview 3-6
- OUT
 - connector 4-3, 5-21
 - described 3-19
- OUT command 6-13, E-7
- OUTFF [n] command 6-14, E-7
- Output
 - offset status control 5-15
 - output expansion 3-13
 - output filter 3-11
 - output offset 3-13
 - ratio calculations 3-16
 - slope control 5-14
 - stability 3-13
 - time constant control 5-14
- OUTPUT LCD ▲ and ▼ keys 5-16
- Overload detection 3-19
- Overload indicators 4-4, 5-3, 5-21
- P [n₁, n₂] command 6-11, E-7
- POWER on/off key 5-25
- Preamplifier power output
 - connector pinout B-1
 - PREAMP POWER connector 4-5
- PSD MONITOR output 3-10, 4-6
- Rack mounting 2-1
- Ratio output 5-19
- Rear Panel layout 4-5
- Reference channel 3-6
- Reference mode
 - 2F 3-1
 - External 3-1, 3-6
 - F 3-1
 - Internal 3-1, 3-6
 - lock acquisition time 3-6
- Reference phase shifter
 - overview 3-8

-
- REMOTE [n] command 6-18, E-8
 - RS [n₁ [n₂]] command 6-16, E-8
 - RS232 and GPIB operation 6-1
 - RS232 interface
 - baud rate control 5-22
 - character echo control 5-23
 - choice of baud rate 6-3
 - choice of number of data bits 6-3
 - choice of parity check option 6-3
 - connector 4-5
 - connector pinout B-1
 - general features 6-2
 - handshaking and echoes 6-4
 - N (overload) command 6-6
 - number of data bits control 5-23
 - number of stop bits control 5-23
 - parity control 5-23
 - prompts 6-6
 - ST (status) command 6-6
 - terminators 6-6
 - SEN [n] command 6-9, E-8
 - SENSITIVITY ▲ and ▼ keys 5-2
 - SET-FREQ/TUNE key 5-5
 - Signal channel inputs 3-2
 - Signal monitor output
 - overview 3-5
 - SIG MON connector 4-1, 5-6
 - Sinewave response mode 3-1
 - SLOPE/RS232 key 5-14
 - Specifications
 - detailed listing of A-1
 - displays and indicators A-1
 - for auxiliary inputs A-3
 - for demodulator A-3
 - for measurement modes A-1
 - for oscillator A-3
 - for outputs A-4
 - for reference channel A-2
 - for signal channel A-1
 - power and dimensions A-4
 - Squarewave response mode 3-1
 - ST command 6-17, E-9
 - Terminators 6-5
 - TIME CONSTANT ▲ and ▼ keys 5-14
 - TRIG [n] command 6-15, E-9
 - TTL IN connector 4-2, 5-13
 - TTL REF OUT connector 3-7, 4-6
 - TUNING LCD ▲ and ▼ keys 5-8
 - Typical lock-in amplifier experiment 5-25
 - UNLK indicator 5-13
 - VER command 6-18, E-10
 - VERNIER/NORM key 5-3
 - What is a lock-in amplifier? 1-2
 - XDB [n] command 6-12, E-11
 - XOF [n₁ [n₂]] command 6-12, E-11
 - XTC [n] command 6-12, E-11

WARRANTY

AMETEK SIGNAL RECOVERY, a part of AMETEK Advanced Measurement Technology, Inc, warrants each instrument of its own manufacture to be free of defects in material and workmanship for a period of ONE year from the date of delivery to the original purchaser. Obligations under this Warranty shall be limited to replacing, repairing or giving credit for the purchase, at our option, of any instruments returned, shipment prepaid, to our Service Department for that purpose, provided prior authorization for such return has been given by an authorized representative of AMETEK Advanced Measurement Technology, Inc.

This Warranty shall not apply to any instrument, which our inspection shall disclose to our satisfaction, to have become defective or unusable due to abuse, mishandling, misuse, accident, alteration, negligence, improper installation, or other causes beyond our control. This Warranty shall not apply to any instrument or component not manufactured by AMETEK Advanced Measurement Technology, Inc. When products manufactured by others are included AMETEK Advanced Measurement Technology, Inc equipment, the original manufacturers Warranty is extended to AMETEK Advanced Measurement Technology, Inc customers. AMETEK Advanced Measurement Technology, Inc reserves the right to make changes in design at any time without incurring any obligation to install same on units previously purchased.

THERE ARE NO WARRANTIES WHICH EXTEND BEYOND THE DESCRIPTION ON THE FACE HEREOF. THIS WARRANTY IS IN LIEU OF, AND EXCLUDES ANY AND ALL OTHER WARRANTIES OR REPRESENTATIONS, EXPRESSED, IMPLIED OR STATUTORY, INCLUDING MERCHANTABILITY AND FITNESS FOR A PARTICULAR PURPOSE, AS WELL AS ANY AND ALL OTHER OBLIGATIONS OR LIABILITIES OF AMETEK ADVANCED MEASUREMENT TECHNOLOGY, INC, INCLUDING, BUT NOT LIMITED TO, SPECIAL OR CONSEQUENTIAL DAMAGES. NO PERSON, FIRM OR CORPORATION IS AUTHORIZED TO ASSUME FOR AMETEK ADVANCED MEASUREMENT TECHNOLOGY, INC ANY ADDITIONAL OBLIGATION OR LIABILITY NOT EXPRESSLY PROVIDED FOR HEREIN EXCEPT IN WRITING DULY EXECUTED BY AN OFFICER OF AMETEK ADVANCED MEASUREMENT TECHNOLOGY, INC.

SHOULD YOUR EQUIPMENT REQUIRE SERVICE

- A. Contact your local AMETEK SIGNAL RECOVERY office, agent, representative or distributor to discuss the problem. In many cases it may be possible to expedite servicing by localizing the problem to a particular unit or cable.
- B. We will need the following information, a copy of which should also be attached to any equipment which is returned for service.
- | | |
|---|---|
| 1. Model number and serial number of instrument | 6. Symptoms (in detail, including control settings) |
| 2. Your name (instrument user) | 7. Your purchase order number for repair charges (does not apply to repairs in warranty) |
| 3. Your address | 8. Shipping instructions (if you wish to authorize shipment by any method other than normal surface transportation) |
| 4. Address to which the instrument should be returned | |
| 5. Your telephone number and extension | |
- C. If you experience any difficulties in obtaining service please contact:

SIGNAL RECOVERY Service
AMETEK Advanced Measurement Technology, Inc
801 South Illinois Avenue
Oak Ridge
TN 37831-2011, USA

Phone: +1 865 483 2121
Fax: +1 865 483 0396
E-mail: service@signalrecovery.com

or

SIGNAL RECOVERY Service
AMETEK Advanced Measurement Technology
Astro House
Brants Bridge,
Bracknell
RG12 9HW, UNITED KINGDOM

Phone: +44 (0)1344 477900
Fax: +44 (0)1344 477901
E-mail: service@signalrecovery.com