



Advanced Test Equipment Rentals
www.atecorp.com 800-404-ATEC (2832)

FLUKE®

724
Temperature Calibrator

Users Manual

February 2000 Rev.1, 8/03

© 2000-2003 Fluke Corporation. All rights reserved.

All product names are trademarks of their respective companies.

LIMITED WARRANTY & LIMITATION OF LIABILITY

Each Fluke product is warranted to be free from defects in material and workmanship under normal use and service. The warranty period is three years and begins on the date of shipment. Parts, product repairs and services are warranted for 90 days. This warranty extends only to the original buyer or end-user customer of a Fluke authorized reseller, and does not apply to fuses, disposable batteries or to any product which, in Fluke's opinion, has been misused, altered, neglected, contaminated, or damaged by accident or abnormal conditions of operation or handling. Fluke warrants that software will operate substantially in accordance with its functional specifications for 90 days and that it has been properly recorded on non-defective media. Fluke does not warrant that software will be error free or operate without interruption.

Fluke authorized resellers shall extend this warranty on new and unused products to end-user customers only but have no authority to extend a greater or different warranty on behalf of Fluke. Warranty support is available only if product is purchased through a Fluke authorized sales outlet or Buyer has paid the applicable international price. Fluke reserves the right to invoice Buyer for importation costs of repair/replacement parts when product purchased in one country is submitted for repair in another country.

Fluke's warranty obligation is limited, at Fluke's option, to refund of the purchase price, free of charge repair, or replacement of a defective product which is returned to a Fluke authorized service center within the warranty period.

To obtain warranty service, contact your nearest Fluke authorized service center to obtain return authorization information, then send the product to that service center, with a description of the difficulty, postage and insurance prepaid (FOB Destination). Fluke assumes no risk for damage in transit. Following warranty repair, the product will be returned to Buyer, transportation prepaid (FOB Destination). If Fluke determines that failure was caused by neglect, misuse, contamination, alteration, accident or abnormal condition of operation or handling, including overvoltage failures caused by use outside the product's specified rating, or normal wear and tear of mechanical components, Fluke will provide an estimate of repair costs and obtain authorization before commencing the work. Following repair, the product will be returned to the Buyer transportation prepaid and the Buyer will be billed for the repair and return transportation charges (FOB Shipping Point).

THIS WARRANTY IS BUYER'S SOLE AND EXCLUSIVE REMEDY AND IS IN LIEU OF ALL OTHER WARRANTIES, EXPRESS OR IMPLIED, INCLUDING BUT NOT LIMITED TO ANY IMPLIED WARRANTY OF MERCHANTABILITY OR FITNESS FOR A PARTICULAR PURPOSE. FLUKE SHALL NOT BE LIABLE FOR ANY SPECIAL, INDIRECT, INCIDENTAL OR CONSEQUENTIAL DAMAGES OR LOSSES, INCLUDING LOSS OF DATA, ARISING FROM ANY CAUSE OR THEORY.

Since some countries or states do not allow limitation of the term of an implied warranty, or exclusion or limitation of incidental or consequential damages, the limitations and exclusions of this warranty may not apply to every buyer. If any provision of this Warranty is held invalid or unenforceable by a court or other decision-maker of competent jurisdiction, such holding will not affect the validity or enforceability of any other provision.

Fluke Corporation
P.O. Box 9090
Everett, WA 98206-9090
U.S.A.

Fluke Europe B.V.
P.O. Box 1186
5602 BD Eindhoven
The Netherlands

Table of Contents

| Title | Page |
|---|------|
| Introduction | 1 |
| Contacting Fluke | 1 |
| Standard Equipment | 3 |
| Safety Information..... | 3 |
| Getting Acquainted with the Calibrator | 8 |
| Input and Output Terminals | 8 |
| Keys | 10 |
| Display | 13 |
| Getting Started | 14 |
| Shut Down Mode | 14 |
| Contrast Adjustment | 16 |
| Using Measure Mode..... | 17 |
| Measuring Electrical Parameters (Upper Display) | 17 |
| Current Measurement with Loop Power..... | 17 |
| Measuring Electrical Parameters (Lower Display) | 19 |
| Measuring Temperature..... | 20 |
| Using Thermocouples | 20 |

| | |
|---|----|
| Using Resistance-Temperature Detectors (RTDs) | 23 |
| Using Source Mode..... | 26 |
| Sourcing Electrical Parameters | 26 |
| Simulating Thermocouples..... | 27 |
| Simulating RTDs..... | 27 |
| Setting 0 % and 100 % Output Parameters | 30 |
| Stepping and Ramping the Output..... | 30 |
| Manually Stepping the Output..... | 30 |
| Auto Ramping the Output..... | 31 |
| Storing and Recalling Setups..... | 31 |
| Calibrating a Transmitter..... | 32 |
| Testing an Output Device..... | 34 |
| Replacing the Batteries | 35 |
| Replacing the Fuse | 35 |
| Maintenance..... | 36 |
| Cleaning the Calibrator..... | 36 |
| Service Center Calibration or Repair..... | 36 |
| Replacement Parts..... | 37 |
| Specifications | 39 |
| DC Voltage Measurement | 39 |
| DC Voltage Source..... | 39 |
| DC mA Measurement..... | 39 |
| Ohms Measurement..... | 40 |
| Ohms Source..... | 40 |
| Millivolt Measurement and Source* | 41 |
| Temperature, Thermocouples | 41 |
| Temperature, RTD Ranges, and Accuracies (ITS-90)..... | 42 |
| Loop Power Supply | 43 |

| | |
|------------------------------|-----------|
| General Specifications | 43 |
| Index | 45 |

List of Tables

| Table | Title | Page |
|--------------|--|-------------|
| 1. | Summary of Source and Measure Functions..... | 2 |
| 2. | International Symbols | 7 |
| 3. | Input/Output Terminals and Connectors | 9 |
| 4. | Key Functions | 11 |
| 5. | Thermocouple Types Accepted | 21 |
| 6. | RTD Types Accepted..... | 24 |
| 7. | Replacement Parts | 37 |

List of Figures

| Figure | Title | Page |
|--------|--|------|
| 1. | Standard Equipment | 6 |
| 2. | Input/Output Terminals and Connectors | 8 |
| 3. | Keys | 10 |
| 4. | Elements of a Typical Display | 13 |
| 5. | Voltage-to-Voltage Test | 15 |
| 6. | Adjusting the Contrast | 16 |
| 7. | Measuring Voltage and Current Output | 17 |
| 8. | Connections for Supplying Loop Power | 18 |
| 9. | Measuring Electrical Parameters | 19 |
| 10. | Measuring Temperature with a Thermocouple | 22 |
| 11. | Measuring Temperature with an RTD, Measuring 2-, 3-, and 4-Wire Resistance | 25 |
| 12. | Electrical Sourcing Connections | 26 |
| 13. | Connections for Simulating a Thermocouple | 28 |
| 14. | Connection for Simulating a 3-Wire RTD | 29 |
| 15. | Calibrating a Thermocouple Transmitter | 33 |
| 16. | Calibrating a Chart Recorder | 34 |
| 17. | Replacing the Batteries | 36 |
| 18. | Replacement Parts | 38 |

Temperature Calibrator

Introduction

Your Fluke 724 Temperature Calibrator is a handheld, battery-operated instrument that measures and sources a variety of thermocouples and RTDs. See Table 1.

In addition to the functions in Table 1, the calibrator has the following features and functions:

- A split-screen display. The upper display allows you to measure volts and current. The lower display allows you to measure and source volts, resistance temperature detectors, thermocouples, and ohms.
- A thermocouple (TC) input/output terminal and internal isothermal block with automatic reference-junction temperature compensation.
- Storage and recall of 8 setups.
- Manual stepping and automatic stepping and ramping.

Contacting Fluke

To order accessories, receive operating assistance, or get the location of the nearest Fluke distributor or Service Center, call:

USA: 1-888-99-FLUKE (1-888-993-5853)

Canada: 1-800-363-5853

Europe: +31 402-675-200

Japan: +81-3-3434-0181

Singapore: +65-738-5655

Anywhere in the world: +1-425-356-5500

Or, visit Fluke's Web site at www.fluke.com.

Table 1. Summary of Source and Measure Functions

| Function | Measure | Source |
|---|--|------------------------------|
| dc V | 0 V to 30 V | 0 V to 10 V |
| Resistance | 0 Ω to 3200 Ω | 15 Ω to 3200 Ω |
| Thermocouple | Types E, J, K, T, B, R, S, L, U, N, mV | |
| RTD (Resistance- Temperature Detector) | Pt100 Ω (385) Pt100 Ω (3926) Pt100 Ω (3916) Pt200 Ω (385) Pt500 Ω (385) Pt1000 Ω (385) Ni120 | |
| Other functions | Loop supply, Step, Ramp, Memory, Dual display | |

Standard Equipment

The items listed below and shown in Figure 1 are included with your calibrator. If the calibrator is damaged or something is missing, contact the place of purchase immediately. To order replacement parts or spares, see the user-replaceable parts list in Table 7.

- TL75 test leads (one set)
- Alligator clips (one set)
- Stackable alligator clip test leads (one set)
- *724 Product Overview Manual*
- *724 CD-ROM* (contains Users Manual)
- Spare fuse

Safety Information

The calibrator is designed in accordance with IEC1010-1, ANSI/ISA S82.01-1994 and CAN/CSA C22.2 No. 1010.1-92. Use the calibrator only as specified in this manual, otherwise the protection provided by the calibrator may be impaired.

A **Warning** identifies conditions and actions that pose hazard(s) to the user; a **Caution** identifies conditions and actions that may damage the calibrator or the equipment under test.

International symbols used on the calibrator and in this manual are explained in Table 2.

⚠ Warning

To avoid possible electric shock or personal injury:

- **Do not apply more than the rated voltage, as marked on the calibrator, between the terminals, or between any terminal and earth ground. Maximum for all terminals is 30 V, 24 mA.**
- **Before each use, verify the calibrator's operation by measuring a known voltage.**
- **Follow all equipment safety procedures.**
- **Never touch the probe to a voltage source when the test leads are plugged into the current terminals.**
- **Do not use the calibrator if it is damaged. Before you use the calibrator, inspect the case. Look for cracks or missing plastic. Pay particular attention to the insulation surrounding the connectors.**
- **Select the proper function and range for your measurement.**
- **Make sure the battery door is closed and latched before you operate the calibrator.**
- **Remove test leads from the calibrator before you open the battery door.**
- **Inspect the test leads for damaged insulation or exposed metal. Check test leads continuity. Replace damaged test leads before you use the calibrator.**
- **When using the probes, keep your fingers away from the probe contacts. Keep your fingers behind the finger guards on the probes.**
- **Connect the common test lead before you connect the live test lead. When you disconnect test leads, disconnect the live test lead first.**
- **Do not use the calibrator if it operates abnormally. Protection may be impaired. When in doubt, have the calibrator serviced.**
- **Do not operate the calibrator around explosive gas, vapor, or dust.**

⚠ Warning

- Use only 4 AA batteries, properly installed in the calibrator case, to power the calibrator.
- Disconnect test leads before changing to another measure or source function.
- When servicing the calibrator, use only specified replacement parts.
- To avoid false readings, which could lead to possible electric shock or personal injury, replace the batteries as soon as the battery indicator (🔋) appears.

Caution

To avoid possible damage to calibrator or to equipment under test:

- Disconnect the power and discharge all high-voltage capacitors before testing resistance or continuity.
- Use the proper jacks, function, and range for your measurement or sourcing application.

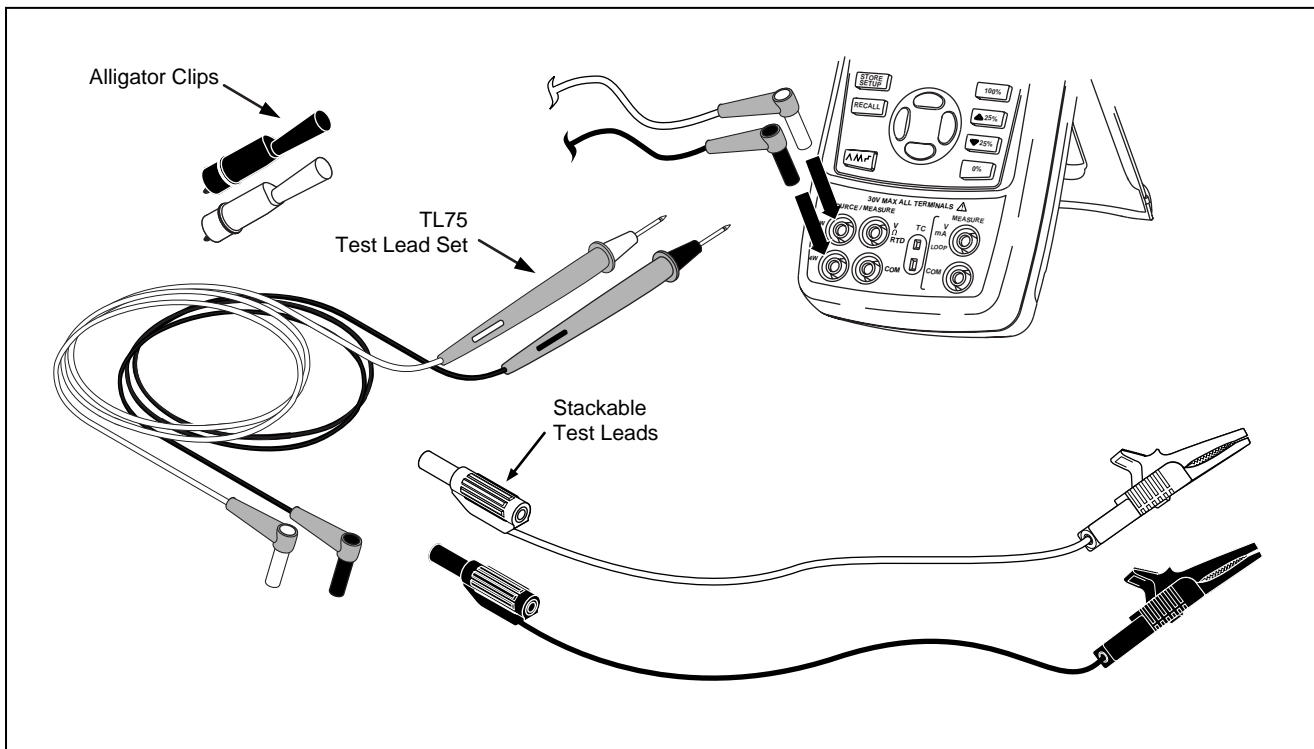

Figure 1. Standard Equipment

zi01f.eps

Table 2. International Symbols

| | |
|---|---|
| AC - Alternating current | Double insulated |
| DC - Direct current | Battery |
| Earth ground | Refer to the manual for information about this feature. |
| Pressure | ON/OFF |
| Conforms to Canadian Standards Association directives | Conforms to European Union directives |

Getting Acquainted with the Calibrator

Input and Output Terminals

Figure 2 shows the calibrator input and output terminals. Table 3 explains their use.

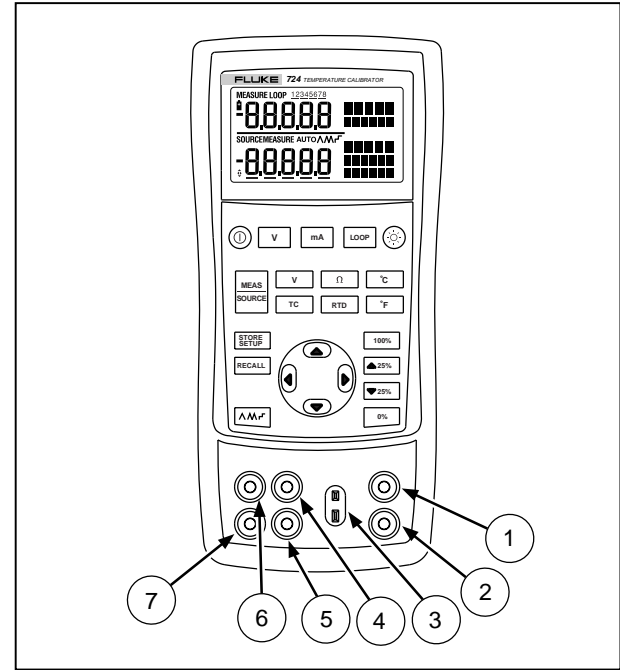

zi02f.eps

Figure 2. Input/Output Terminals and Connectors

Table 3. Input/Output Terminals and Connectors

| No | Name | Description |
|-----------|--|--|
| ①, ② | MEASURE V, mA terminals | Input terminals for measuring voltage, current, and supplying loop power. |
| ③ | TC input/output | Terminal for measuring or simulating thermocouples. This terminal accepts a miniature polarized thermocouple plug with flat, in-line blades spaced 7.9 mm (0.312 in) center to center. |
| ④, ⑤ | SOURCE/ MEASURE V, RTD, Ω terminals | Terminals for sourcing or measuring voltage, resistance, and RTDs. |
| ⑥, ⑦ | MEASURE 3W, 4W | Terminals for performing 3W and 4W RTD measurements. |

Keys

Figure 3 shows the calibrator keys and Table 4 explains their use.

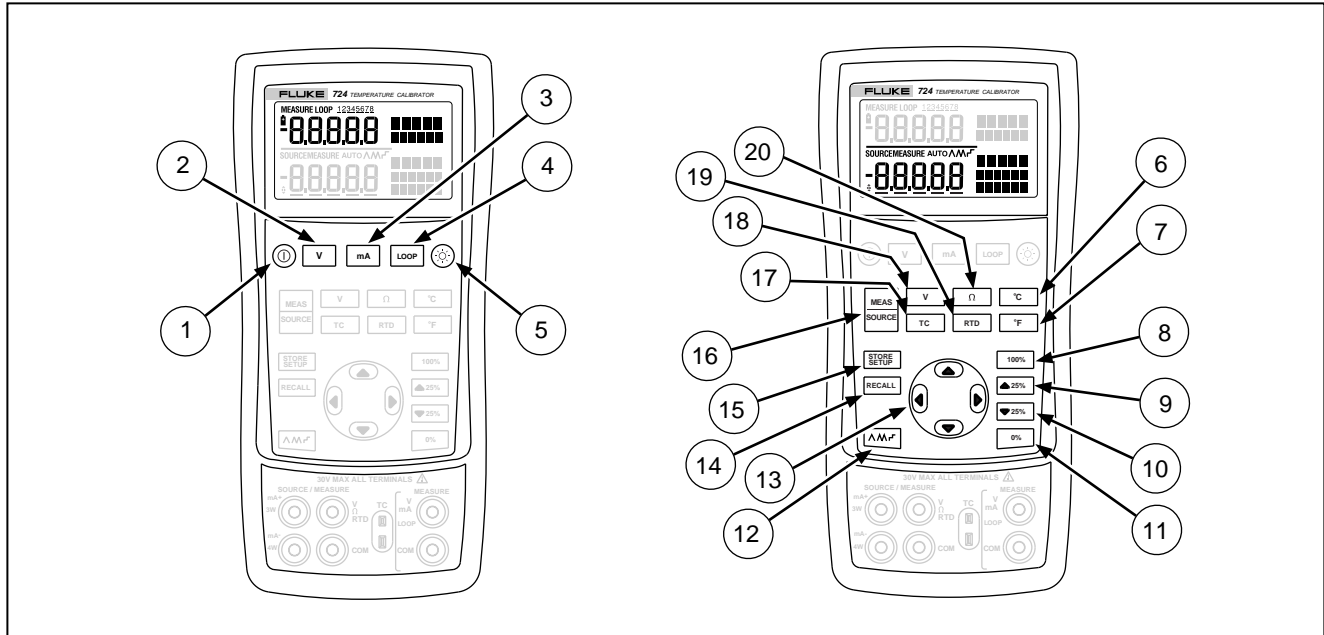













Figure 3. Keys

zi03f.eps

Table 4. Key Functions

| No | Name | Description |
|----|-------|--|
| ① | ⓘ | Turns the power on or off. |
| ② | V | Selects voltage measurement function in the upper display. |
| ③ | mA | Selects the mA measurement function in the upper display. |
| ④ | LOOP | Activates a 24-volt loop supply while measuring mA. |
| ⑤ | ☉ | Turns backlight on or off. Turns contrast adjust mode on when powering up. |
| ⑥ | °C | Displays temperature in degrees Celsius when in TC or RTD functions. |
| ⑦ | °F | Displays temperature in degrees Fahrenheit when in TC or RTD functions. |
| ⑧ | 100% | Recalls from memory a source value corresponding to 100 % of span and sets it as the source value. Press and hold to store any source value as the 100 % value. |
| ⑨ | ▲ 25% | Increments output by 25 % of span. |
| ⑩ | ▼ 25% | Decrements output by 25 % of span. |
| ⑪ | 0% | Recalls from memory a source value corresponding to 0 % of span and sets it as the source value. Press and hold to store the source value as the 0 % value. Identifies Firmware version. Press and hold 0% when powering up. |

Table 4. Key Functions (cont.)

| No | Name | Description |
|-----|---|--|
| ⑫ |  | Cycles through : \wedge Slow repeating 0 % - 100 % - 0 % ramp \wedge Fast repeating 0 % - 100 % - 0 % ramp \lrcorner Repeating 0 % - 100 % - 0 % ramp in 25 % steps |
| ① ⑬ |  | Disables Shut Down Mode |
| ① ⑬ |  | Enables Shut Down Mode |
| ⑬ |  | Increases or decreases the source level. Cycles through the 2-, 3-, and 4-wire selections. Moves through the eight memory locations of calibrator setups. In Contrast Adjustment mode; up-darkens contrast, down-lightens contrast. |
| ⑭ |  | Retrieves a previous calibrator setup from one of eight memory locations. |
| ⑮ |  | Saves the calibrator setup to one of eight memory locations. Saves Contrast Adjustment setup. |
| ⑯ |  | Cycles the calibrator through MEASURE and SOURCE modes in the lower display. |
| ⑰ |  | Selects TC (thermocouple) measurement and sourcing function in the lower display. Repeated pushes cycle through the thermocouple types. |
| ⑱ |  | Toggles between voltage, sourcing, and measuring functions in the lower display. |
| ⑲ |  | Selects RTD (resistance temperature detector) measurement and sourcing function in lower display. Repeated pushes cycle through the RTD types. |
| ⑳ |  | Selects the ohms measurement and sourcing function. |

Display

Figure 4 shows the elements of a typical display.

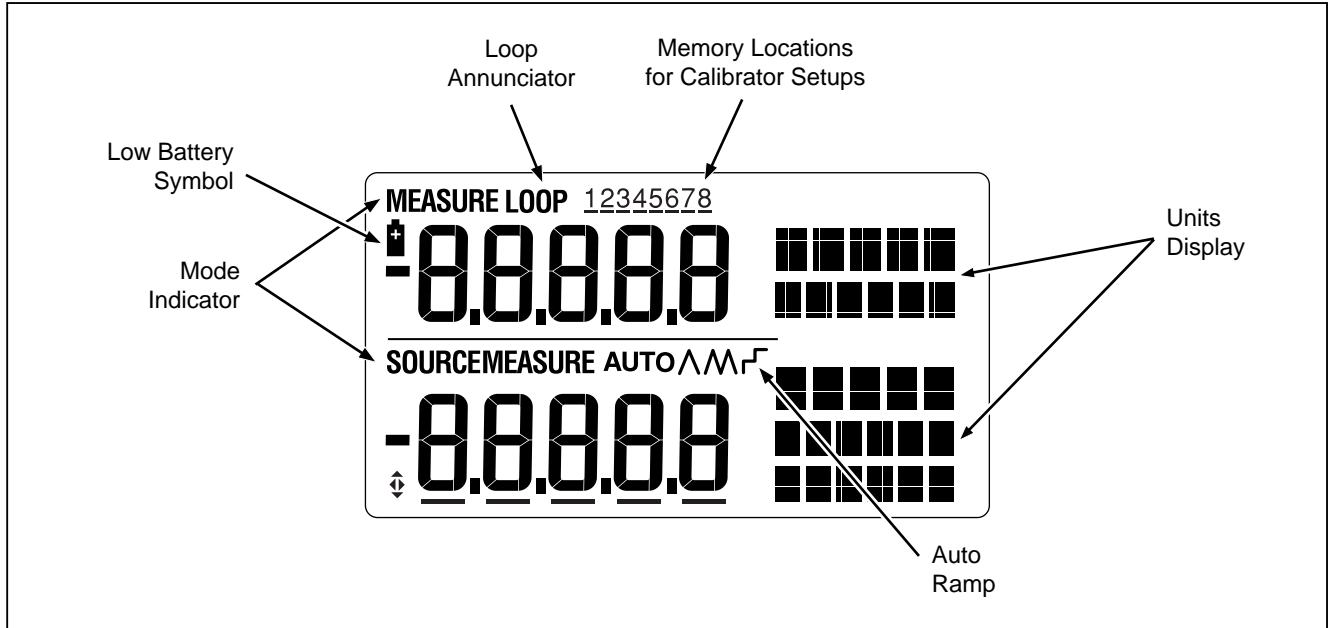









Figure 4. Elements of a Typical Display





sh07f.eps

Getting Started









This section acquaints you with some basic operations of the calibrator.

Proceed as follows to perform a voltage-to-voltage test:

1. Connect the calibrator's voltage output to its voltage input as shown in Figure 5.
2. Press  to turn on the calibrator. Press  to select dc voltage (upper display).
3. If necessary, press  for SOURCE mode (lower display). The calibrator is still measuring dc voltage, and you can see the active measurements in the upper display.
4. Press  to select dc voltage sourcing.
5. Press  and  to select a digit to change. Press  to select 1 V for the output value. Press and hold  to enter 1 V as the 0 % value.

6. Press  to increase the output to 5 V. Press and hold  to enter 5 V as the 100 % value.
7. Press  and  to step between 0 and 100 % in 25 % step increments.

Shut Down Mode

The calibrator comes with the Shut Down mode enabled for a time duration set to 30 minutes (displayed for about 1 second when the calibrator is initially turned on). When the Shut Down mode is enabled, the calibrator will automatically shut down after the time duration has elapsed from the time the last key was pressed. To disable the Shut Down mode, press  and  simultaneously. To enable the mode, press  and  simultaneously. To adjust the time duration, press  and  simultaneously, then press  and/or  to adjust the time between 1 and 30 minutes.

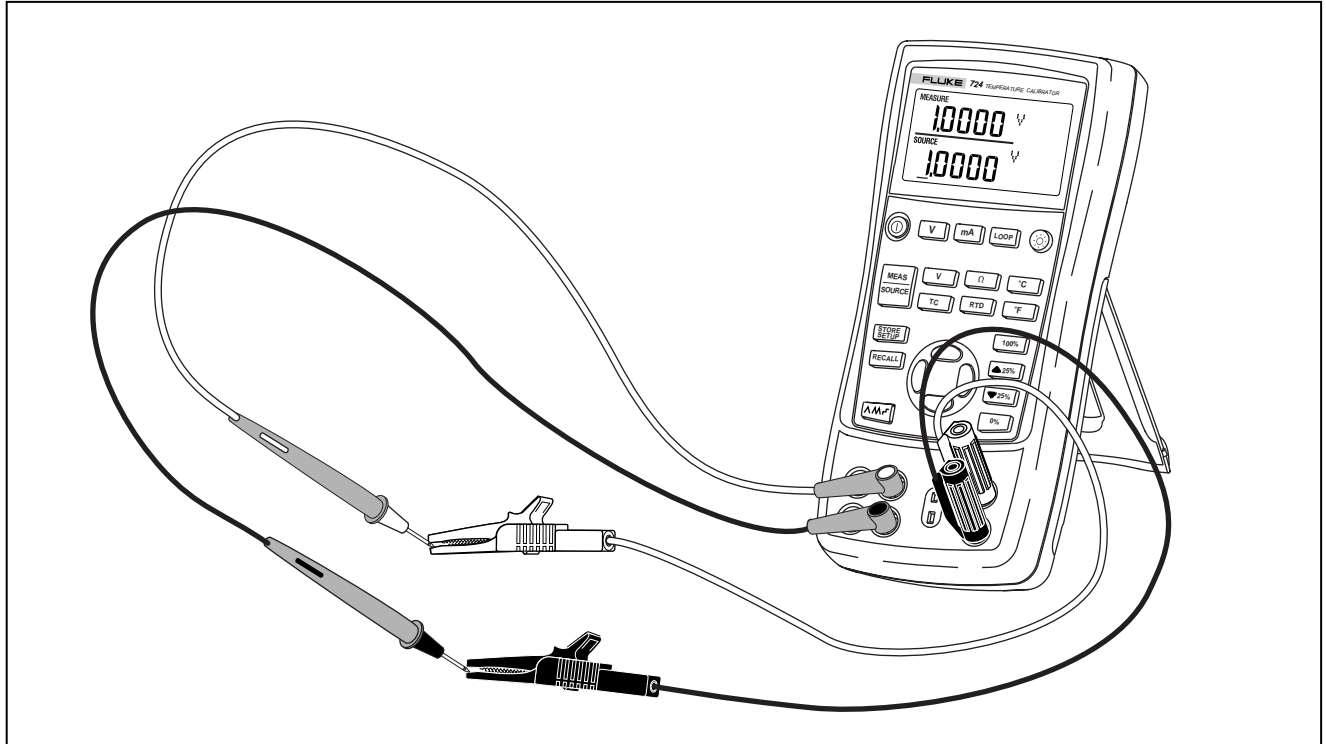

Figure 5. Voltage-to-Voltage Test

zi04f.eps

Contrast Adjustment

Note

Available with V2.1 Firmware or greater. To identify firmware version, press and hold **0%** when powering up. The firmware version will be shown in the upper units display for about 1 second after initialization.

To adjust the contrast, proceed as follows:

1. Press **⊙** and **⊕** until Contst Adjust is displayed as shown in Figure 6.
2. Press and hold **☰** to darken contrast.
3. Press and hold **☷** to lighten contrast.
4. Press **STORE SETUP** to save the contrast level.

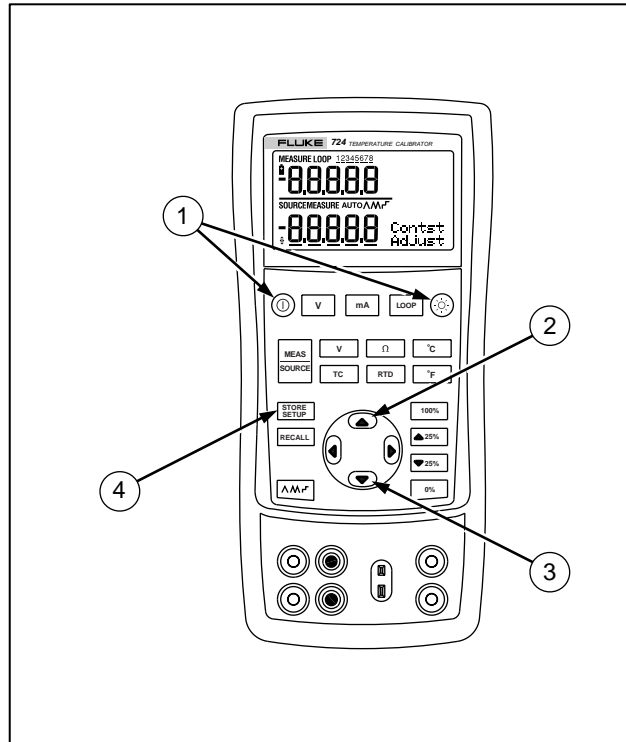

Figure 6. Adjusting the Contrast

zi15f.eps

Using Measure Mode

Measuring Electrical Parameters (Upper Display)

To measure the current or voltage output of a transmitter, use the upper display and proceed as follows:

1. Press **mA** to select current. LOOP should not be on.
2. Connect the leads as shown in Figure 7.

Current Measurement with Loop Power

The loop power function activates a 24 V supply in series with the current measuring circuit, allowing you to test a

transmitter when it is disconnected from plant wiring. To measure current with loop power, proceed as follows:

1. Connect the calibrator to the transmitter current loop terminals as shown in Figure 8.
2. Press **LOOP** while the calibrator is in current measurement mode. LOOP appears and an internal 24 V loop supply turns on.

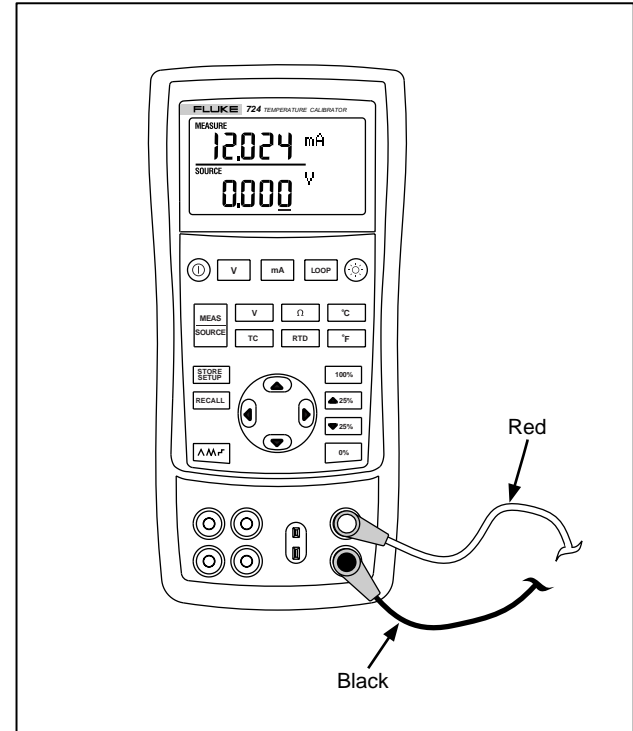

Figure 7. Measuring Voltage and Current Output

zi05f.eps

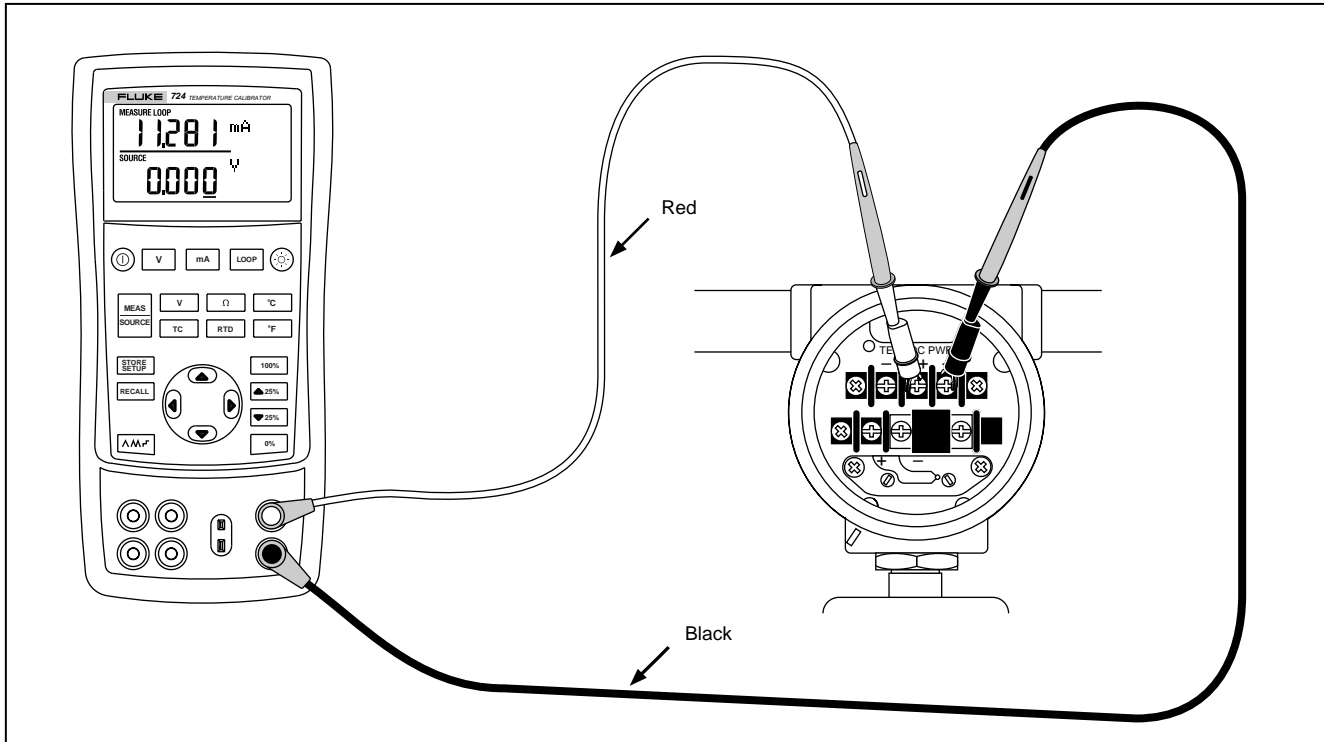





Figure 8. Connections for Supplying Loop Power

zi06f.eps

Measuring Electrical Parameters (Lower Display)

To measure the electrical parameters using the lower display, proceed as follows:

1. Connect the calibrator as shown in Figure 9.
2. If necessary, press  for MEASURE mode (lower display)
3. Press  for dc voltage or current, or  for resistance.

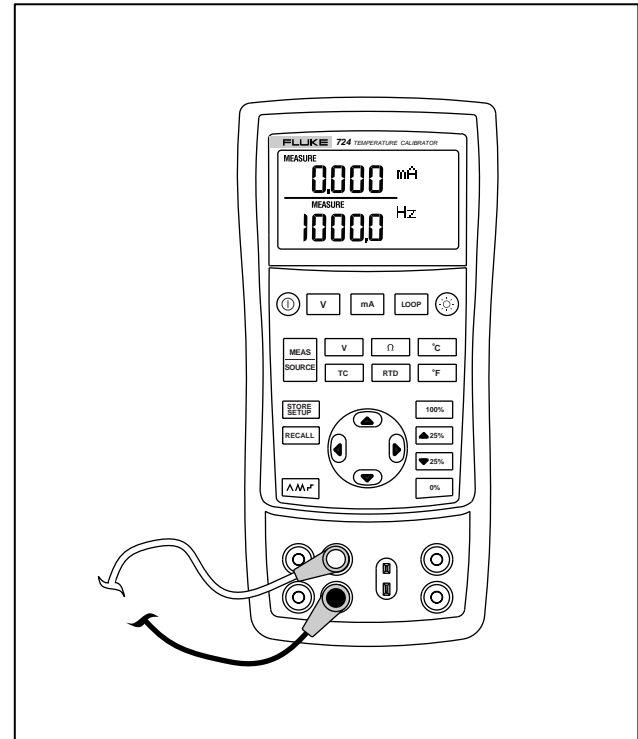

Figure 9. Measuring Electrical Parameters

zi07f.eps

Measuring Temperature

Using Thermocouples

The calibrator supports ten standard thermocouples, including types E, N, J, K, T, B, R, S, L, or U. Table 5 summarizes the ranges and characteristics of the supported thermocouples.



To measure temperature using a thermocouple, proceed as follows:

1. Attach the thermocouple leads to the appropriate TC miniplug, then to the TC input/output as shown in Figure 10.

Note

One pin is wider than the other. Do not try to force a miniplug in the wrong polarization.

If the calibrator and the thermocouple plug are at different temperatures, wait one minute or more for the connector temperature to stabilize after you plug the miniplug into the TC input/output.

2. If necessary, press  for MEASURE mode.
3. Press  for the TC display. If desired, continue pressing this key to select the desired thermocouple type.



If necessary, you can select °C temperature units by pressing , or °F temperature units by pressing .

Table 5. Thermocouple Types Accepted

| Type | Positive Lead Material | Positive Lead (H) Color | | Negative Lead Material | Specified Range (°C) |
|------|-------------------------|-------------------------|--------|------------------------|----------------------|
| | | ANSI* | IEC** | | |
| E | Chromel | Purple | Violet | Constantan | -200 to 950 |
| N | Ni-Cr-Si | Orange | Pink | Ni-Si-Mg | -200 to 1300 |
| J | Iron | White | Black | Constantan | -200 to 1200 |
| K | Chromel | Yellow | Green | Alumel | -200 to 1370 |
| T | Copper | Blue | Brown | Constantan | -200 to 400 |
| B | Platinum (30 % Rhodium) | Gray | | Platinum (6 % Rhodium) | 600 to 1800 |
| R | Platinum (13 % Rhodium) | Black | Orange | Platinum | -20 to 1750 |
| S | Platinum (10 % Rhodium) | Black | Orange | Platinum | -20 to 1750 |
| L | Iron | | | Constantan | -200 to 900 |
| U | Copper | | | Constantan | -200 to 400 |

*American National Standards Institute (ANSI) device negative lead (L) is always red.
 **International Electrotechnical Commission (IEC) device negative lead (L) is always white.

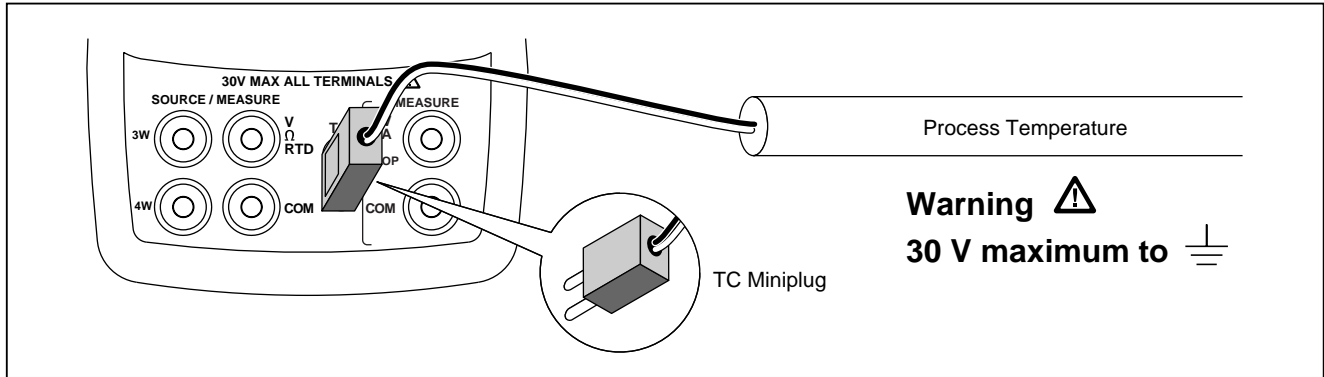





Figure 10. Measuring Temperature with a Thermocouple

zi14f.eps

Using Resistance-Temperature Detectors (RTDs)

The calibrator accepts RTD types shown in Table 6. RTDs are characterized by their resistance at 0 °C (32 °F), which is called the “ice point” or R_0 . The most common R_0 is 100 Ω . The calibrator accepts RTD measurement inputs in two-, three-, or four-wire connections, with the three-wire connection the most common. A four-wire configuration provides the highest measurement precision, and two-wire provides the lowest measurement precision.

To measure temperature using an RTD input, proceed as follows:

1. If necessary, press  for MEASURE mode.
2. Press  for the RTD display. If desired, continue pressing this key to select the desired RTD type.
3. Press  or  to select a 2-, 3-, or 4- wire connection.
4. Attach the RTD to input terminals as shown in Figure 11.

If necessary, you can select °C temperature units by pressing , or °F temperature units by pressing



Table 6. RTD Types Accepted

| RTD Type | Ice Point (R_0) | Material | α | Range ($^{\circ}\text{C}$) |
|--------------|---------------------|----------|------------------------------------|------------------------------|
| Pt100 (3926) | 100 Ω | Platinum | 0.003926 $\Omega/^{\circ}\text{C}$ | -200 to 630 |
| Pt100 (385) | 100 Ω | Platinum | 0.00385 $\Omega/^{\circ}\text{C}$ | -200 to 800 |
| Ni120 (672) | 120 Ω | Nickel | 0.00672 $\Omega/^{\circ}\text{C}$ | -80 to 260 |
| Pt200 (385) | 200 Ω | Platinum | 0.00385 $\Omega/^{\circ}\text{C}$ | -200 to 630 |
| Pt500 (385) | 500 Ω | Platinum | 0.00385 $\Omega/^{\circ}\text{C}$ | -200 to 630 |
| Pt1000 (385) | 1000 Ω | Platinum | 0.00385 $\Omega/^{\circ}\text{C}$ | -200 to 630 |
| Pt100 (3916) | 100 Ω | Platinum | 0.003916 $\Omega/^{\circ}\text{C}$ | -200 to 630 |

The Pt100 commonly used in U.S. industrial applications is Pt100 (3916), $\alpha = 0.003916 \Omega/^{\circ}\text{C}$. (Also designated as JIS curve.) The IEC standard RTD is the Pt100 (385), $\alpha = 0.00385 \Omega/^{\circ}\text{C}$.

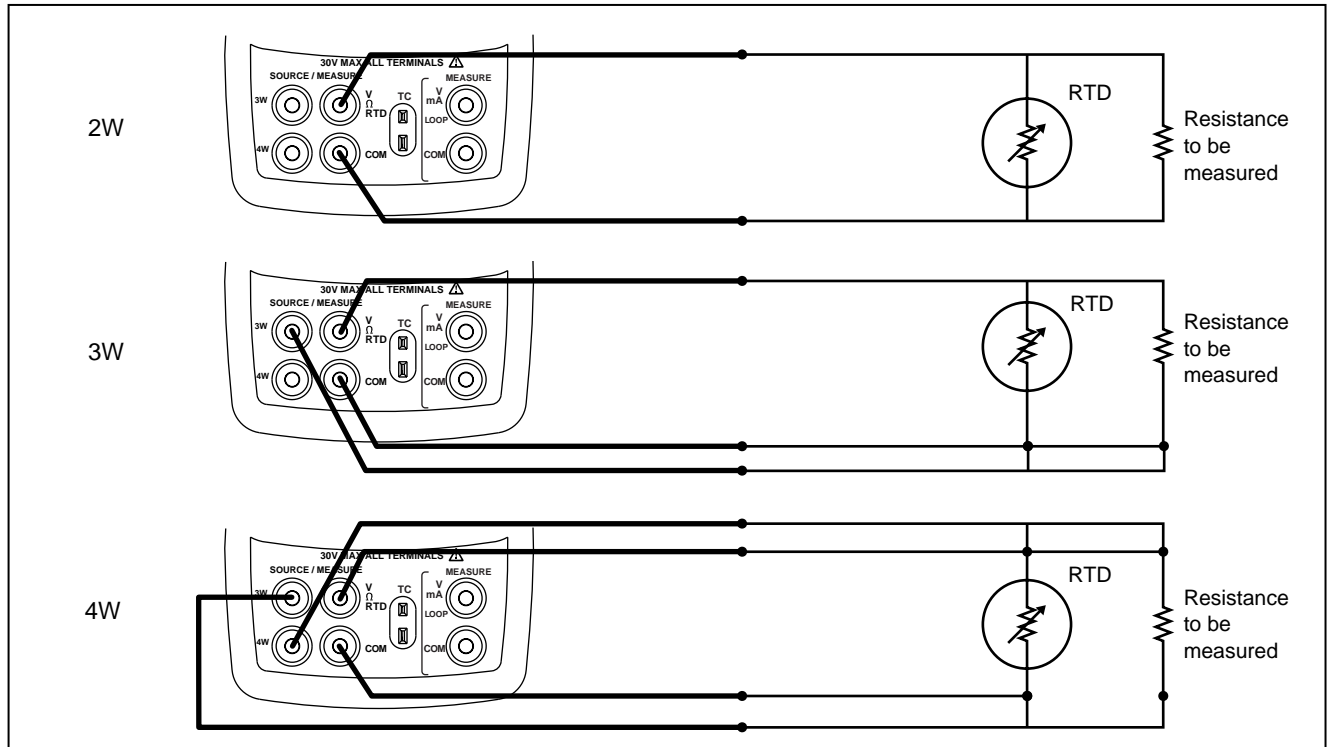

Figure 11. Measuring Temperature with an RTD, Measuring 2-, 3-, and 4-Wire Resistance

zi08f.eps







Using Source Mode

In SOURCE mode, the calibrator generates calibrated signals for testing and calibrating process instruments, supplies voltages and resistances, and simulates the electrical output of RTD and thermocouple temperature sensors.

Sourcing Electrical Parameters

Volts or ohms are sourced and shown in the lower display.

To select an electrical sourcing function, proceed as follows:

1. Connect the test leads as shown in Figure 12, depending on the source function.
2. If necessary, press  for SOURCE mode.
3. Press  for dc voltage, or  for resistance.
4. Enter the desired output value by pressing  and  keys. Press  and  to select a different digit to change.

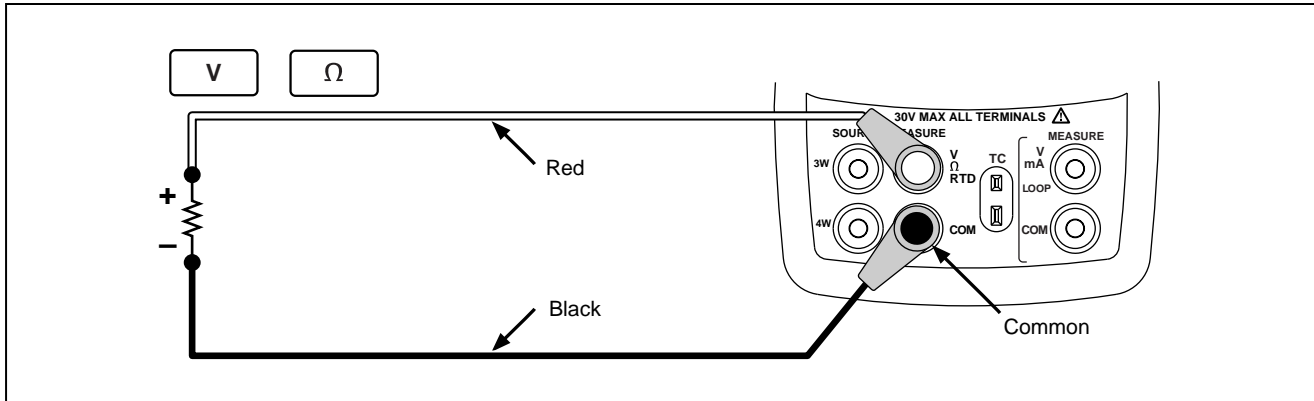

Figure 12. Electrical Sourcing Connections

zi09f.eps







Simulating Thermocouples

Connect the calibrator TC input/output to the instrument under test with thermocouple wire and the appropriate thermocouple mini-connector (polarized thermocouple plug with flat, in-line blades spaced 7.9 mm [0.312 in] center to center).

Note

One pin is wider than the other. Do not try to force a miniplug in the wrong polarization. Figure 13 shows this connection.

Proceed as follows to simulate a thermocouple:

1. Attach the thermocouple leads to the appropriate TC miniplug, then to the TC input/output as shown in Figure 13.
2. If necessary, press  for SOURCE mode.
3. Press  for the TC display. If desired, continue pressing this key to select the desired thermocouple type.
4. Enter the temperature you want by pressing  and  keys. Press  and  to select a different digit to edit.





Simulating RTDs

Connect the calibrator to the instrument under test as shown in Figure 14. Proceed as follows to simulate an RTD:

1. If necessary, press  for SOURCE mode.
2. Press  for the RTD display.

Note

Use the 3W and 4W terminals for measurement only, not for simulation. The calibrator simulates a 2-wire RTD at its front panel. To connect to a 3-wire or 4-wire transmitter, use the stacking cables to provide the extra wires. See Figure 14.

3. Enter the temperature you want by pressing  and  keys. Press  and  to select a different digit to edit.
4. If the 724 display indicates Exl HI the excitation current from your device under test exceeds the limits of the 724.

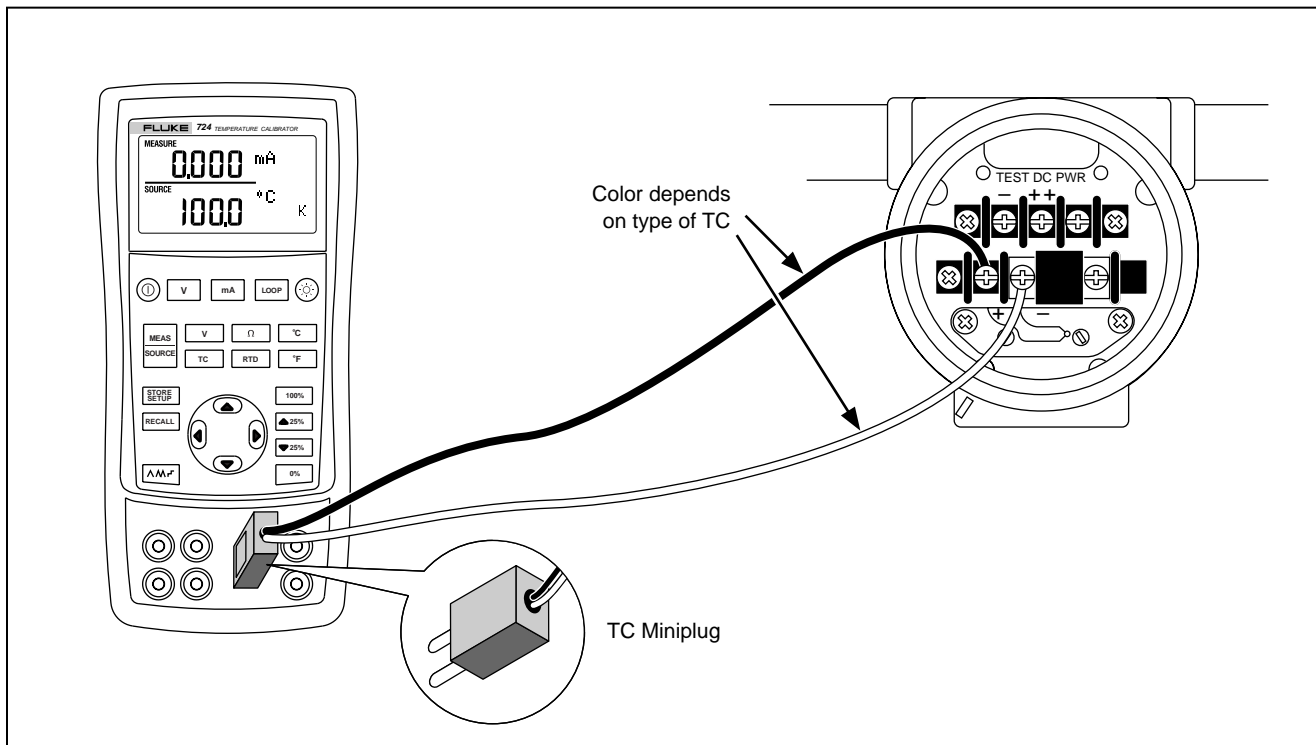

Figure 13. Connections for Simulating a Thermocouple

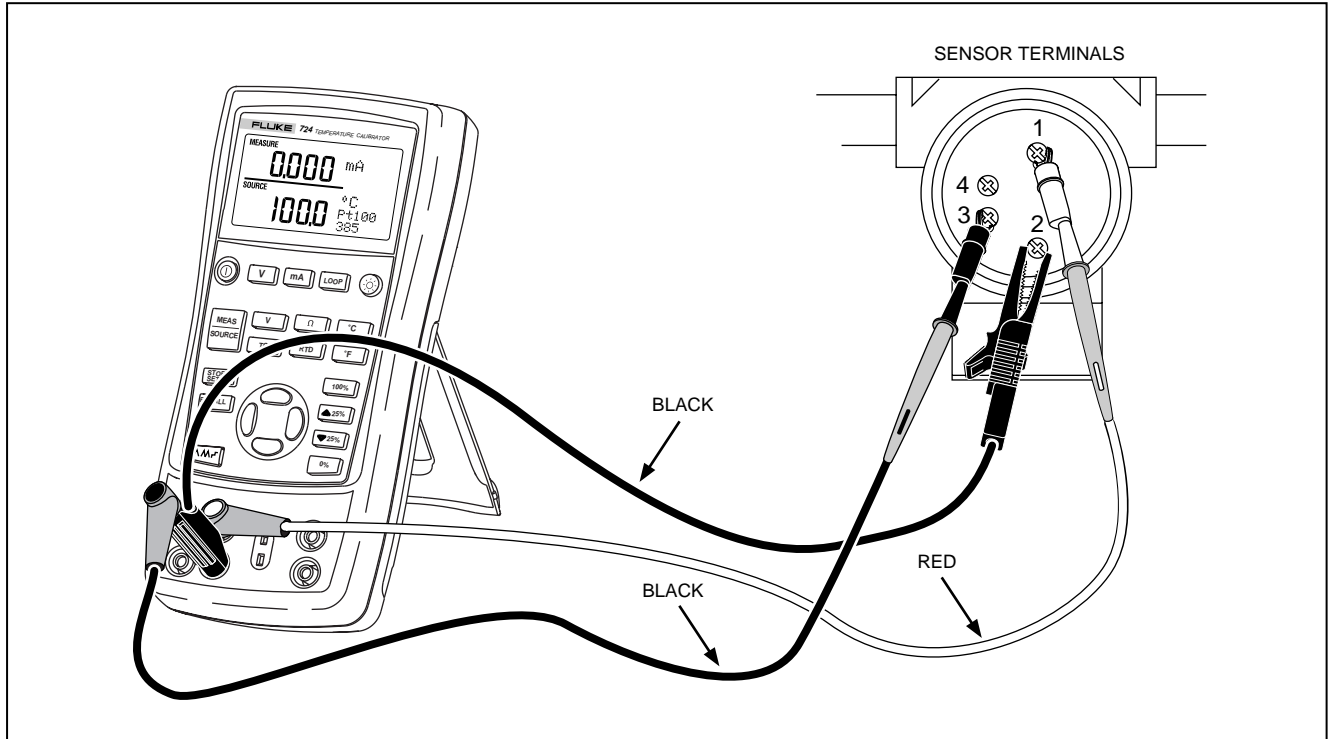





Figure 14. Connections for Simulating 3-Wire RTD



zi11f.eps

Setting 0 % and 100 % Output Parameters

For output parameters (volts, ohms, TC potentials or RTD resistances), you must set the 0 % and 100 % points before you can use the step and ramp functions. Proceed as follows:



1. If necessary, press  for SOURCE mode.
2. Select the TC source function and use the arrow keys to enter the value. Our example is thermocouple source using 100 °C and 300 °C values for source.
3. Enter 100 °C and press and hold  to store the value.
4. Enter in 300 °C and press and hold  to store the value.

You can now use this setting for the following:

- Manually stepping an output with 25 % increments.
- Jump between the 0 and 100 % span points by momentarily pushing  or .

Stepping and Ramping the Output





Two features are available for adjusting the value of source functions.

- Stepping the output manually with the  and  keys, or in automatic mode.
- Ramping the output.

Stepping and ramping apply to all functions.

Manually Stepping the Output



To manually step the output you can do the following:

- Use  or  to step the output up or down in 25 % steps.
- Touch momentarily either  to go to 0 %, or  to go to 100 %.

Auto Ramping the Output

Auto ramping gives you the ability to continuously apply a varying stimulus from the calibrator to a transmitter, while your hands remain free to test the response of the transmitter.





When you press , the calibrator produces a continuously repeating 0 % - 100 % - 0 % ramp in your choice of three ramp waveforms:

-  0 % - 100 % - 0 % 40-second smooth ramp
-  0 % - 100 % - 0 % 15-second smooth ramp
-  0 % - 100 % - 0 % Stair-step ramp in 25 % steps, pausing 5 seconds at each step.





To exit ramping, press any button.

Storing and Recalling Setups

You can store up to eight of your settings in a nonvolatile memory and recall the settings for later use. A low battery condition or a battery change does not jeopardize the stored settings. Proceed as follows:

1. After you create a calibrator setup, press . In the display, the memory locations appear.
2. Press  or  to select locations one through eight. An underscore appears below the selected memory location.
3. Press . Only the stored memory location will be displayed. The setup is stored.









To recall setups, proceed as follows.

1. Press . The memory locations appear on the display.
2. Press  or  to select the appropriate location and press .

Calibrating a Transmitter

Use the measurement (upper display) and source (lower display) modes to calibrate a transmitter. The following example shows how to calibrate a temperature transmitter.

Connect the calibrator to the instrument under test as shown in Figure 15. Proceed as follows to calibrate a transmitter:

1. Press  for current measurement with loop power.
2. Press  (lower display). If desired, continue pressing this key to select the desired thermocouple type.
3. If necessary, press  for SOURCE mode.
4. Set your zero and span parameters by pressing  and  keys. Enter these parameters by pressing and holding  and . For more information on setting parameters, see “Setting 0 % and 100 %” earlier in this manual.
5. Perform test checks at 0-25-50-75-100 % points by pressing  or . Adjust the transmitter as necessary.

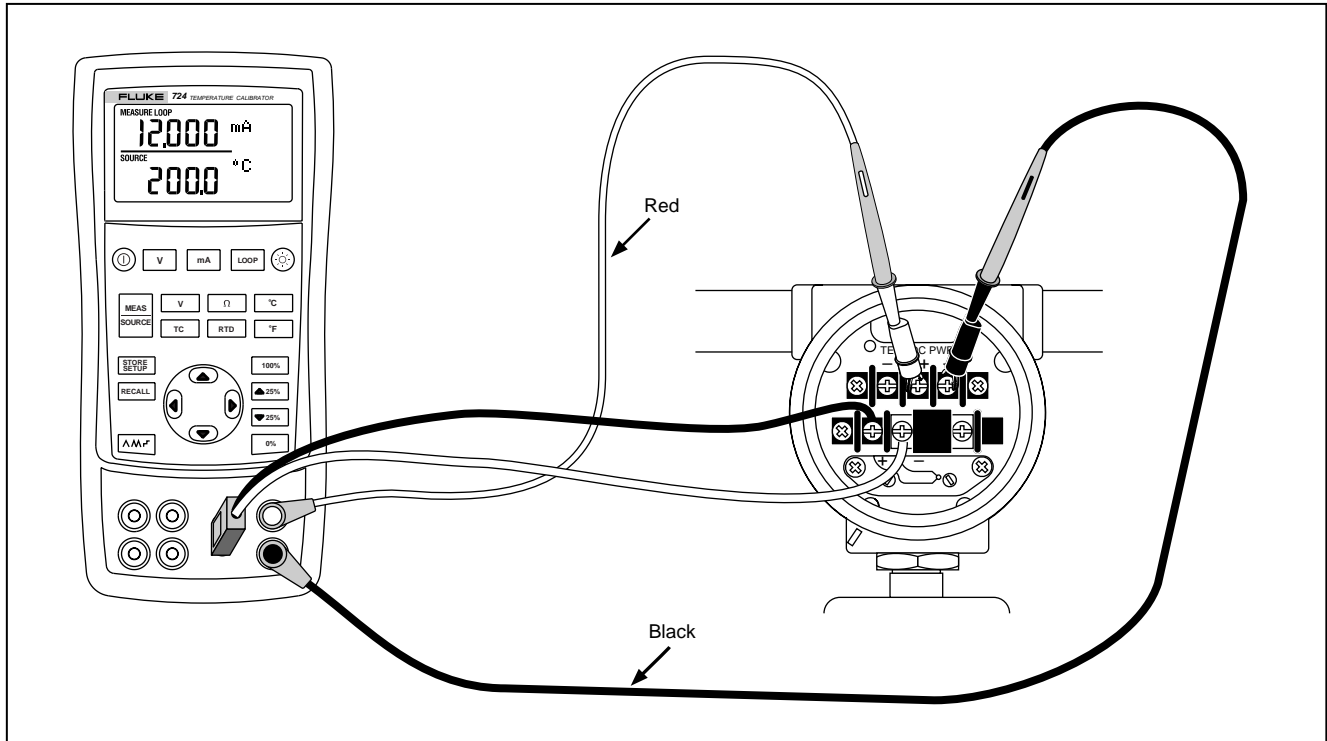

Figure 15. Calibrating a Thermocouple Transmitter

zi12f.eps

Testing an Output Device

Use the source functions to test and calibrate actuators, recording, and indicating devices. Proceed as follows:

1. Connect the test leads to the instrument under test as shown in Figure 16.
2. Press \square v for dc voltage, or \square Ω for resistance (lower display).
3. If necessary, press \square MEAS SOURCE for SOURCE mode.

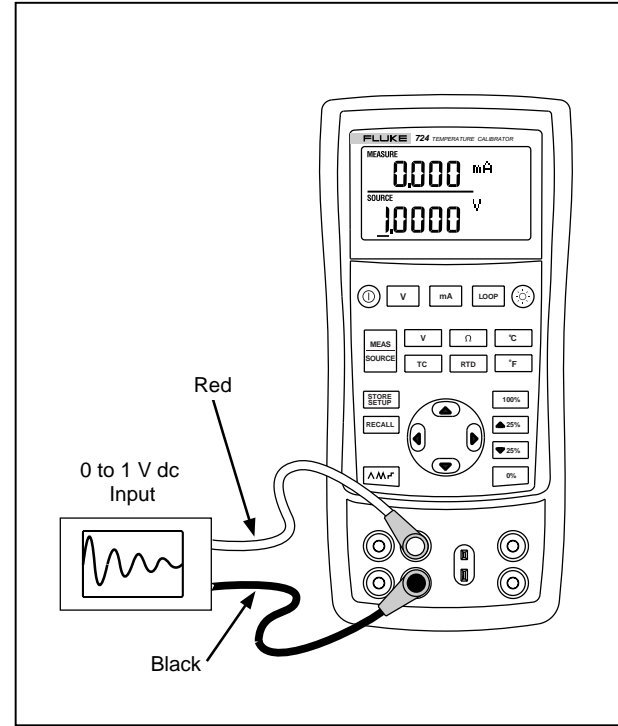

zi13f.eps

Figure 16. Calibrating a Chart Recorder

Replacing the Batteries

⚠ Warning

To avoid false readings, which could lead to possible electric shock or personal injury, replace the batteries as soon as the battery indicator (🔋) appears.

Figure 17 shows you how to replace the batteries.

Replacing the Fuse

The calibrator comes equipped with one 0.05A, 250V, socketed fuse to protect the calibrator.

⚠ Warning

To avoid electrical shock, remove the test leads from the calibrator before opening the battery door. Close and latch the battery door before using the calibrator.

The fuse can be removed and checked for resistance. A value of $< 10 \Omega$ is good. Problems while measuring using the right jacks indicate that F3 may have opened. To replace the fuse, refer to Figure 17 and perform the following steps:

1. Turn the calibrator off, remove the test leads from the terminals, and hold the calibrator face down.
2. Using a flat-blade screwdriver, turn the battery door screws 1/4-turn counterclockwise and remove the battery door.
3. Remove and replace the damaged fuse.
4. Replace the battery door and secure it by turning the screws 1/4-turn clockwise.

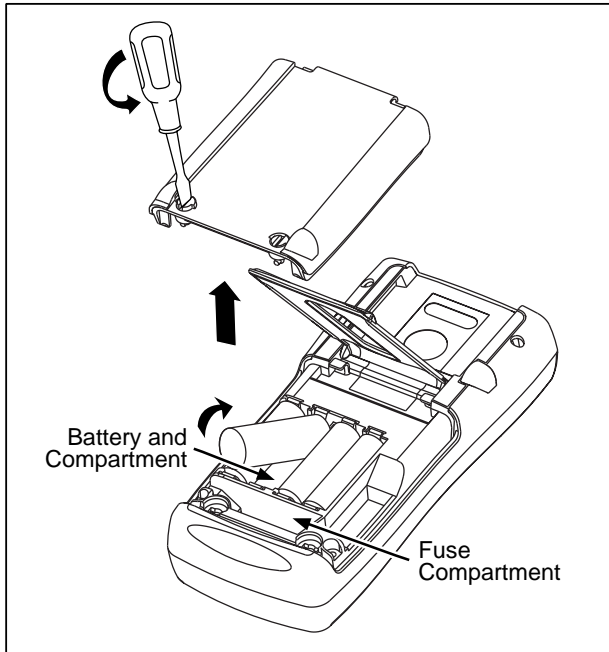

sh38f.eps

Figure 17. Replacing the Batteries

Maintenance

Cleaning the Calibrator

⚠ Warning

To avoid personal injury or damage to the calibrator, use only the specified replacement parts and do not allow water into the case.

Caution

To avoid damaging the plastic lens and case, do not use solvents or abrasive cleansers.

Clean the calibrator with a soft cloth dampened with water or water and mild soap.

Service Center Calibration or Repair

Calibration, repairs, or servicing not covered in this manual should be performed only by qualified service personnel. If the calibrator fails, check the batteries first, and replace them if needed.

Verify that the calibrator is being operated in accordance with the instructions in this manual. If the calibrator is faulty, send a description of the failure with the calibrator. Be sure to pack the calibrator securely, using the original shipping container if it is available. Send the equipment

postage paid and insured, to the nearest Service Center. Fluke assumes no responsibility for damage in transit.

The Fluke 724 Temperature Calibrator covered by the warranty will be promptly repaired or replaced (at Fluke's option) and returned to you at no charge. See the warranty at the beginning of this manual for warranty terms. If the warranty period has expired, the calibrator will be repaired and returned for a fixed fee. If the calibrator is not covered under the warranty terms, contact an authorized service center for a price quote for repair.

To locate an authorized service center, refer to "Contacting Fluke" at the beginning of the manual.

Replacement Parts

Table 7 lists the part number of each replaceable part. Refer to Figure 18.

Table 7. Replacement Parts

| Item | Description | PN | Qty. |
|------|----------------------|---------|------|
| 1 | Case top | 664232 | 1 |
| 2 | LCD mask | 1548383 | 1 |
| 3 | Elastomeric strips | 802063 | 2 |
| 4 | Input/output bracket | 1549221 | 1 |
| 5 | LCD bracket | 667287 | 1 |

| | | | |
|----|--|--------------------|--------|
| 6 | Mounting screws | 494641 | 11 |
| 7 | Backlight | 690336 | 1 |
| 8 | LCD | 690963 | 1 |
| 9 | Keypad | 1548126 | 1 |
| 10 | Case bottom | 664235 | 1 |
| 11 | AA alkaline batteries | 376756 | 4 |
| 12 | Case screws | 832246 | 4 |
| 13 | Battery door | 664250 | 1 |
| 14 | Accessory mount | 658424 | 1 |
| 15 | Tilt stand | 659026 | 1 |
| 16 | Battery door 1/4-turn fasteners | 948609 | 2 |
| 17 | TL75 series test leads | 855742 | 1 |
| 18 | Test lead, red Test lead, black | 688051 688066 | 1 1 |
| 19 | 724 Product Overview Manual | 1547851 | 1 |
| 20 | AC72 alligator clip, red AC72 alligator clip, black | 1670641 1670652 | 1 1 |
| 21 | CD-ROM (includes the 724 Users Manual) | 1547849 | 1 |
| 22 | Top case decal | 1548329 | 1 |
| 23 | Fuse 0.05A/250V | 2002234 | 1 |

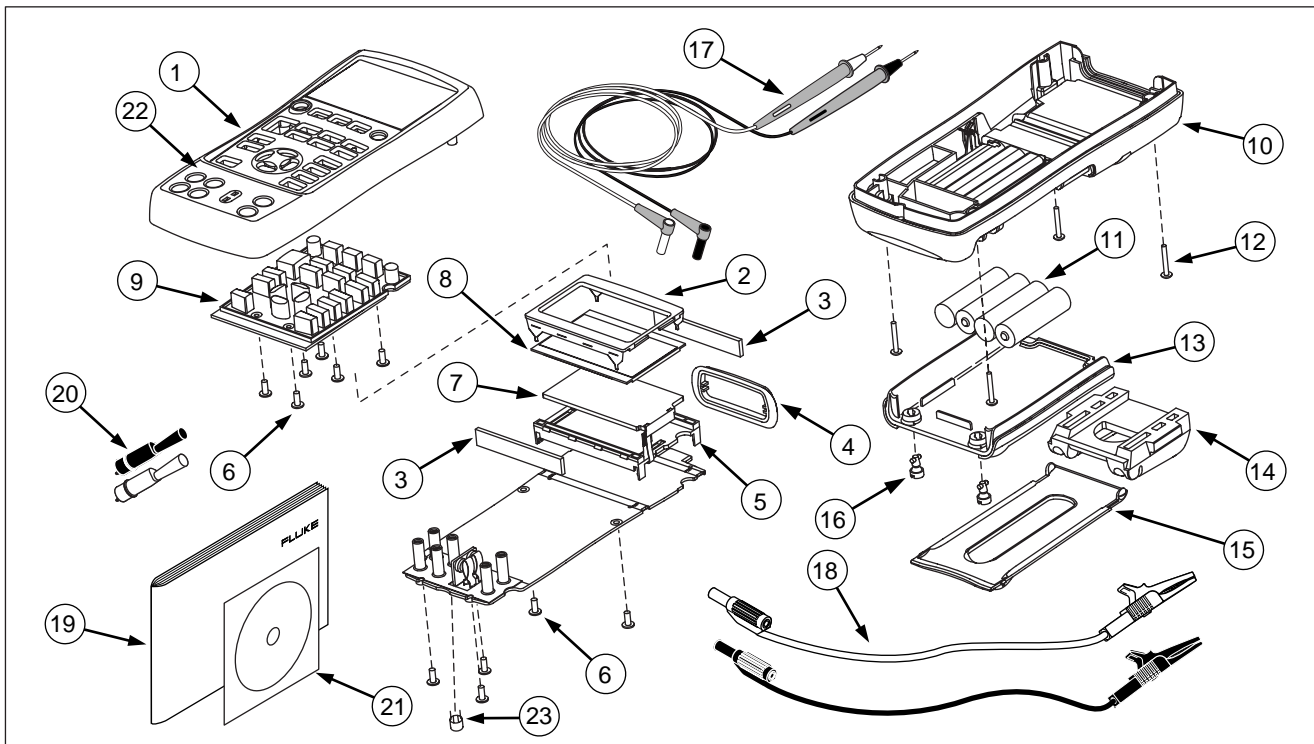

Figure 18. Replacement Parts

zi46f.eps

Specifications

Specifications are based on a one year calibration cycle and apply from +18 °C to +28 °C unless stated otherwise. All specifications assume a 5 minute warmup period.

DC Voltage Measurement

| Range | Resolution | Accuracy, (% of Reading + Counts) |
|---|------------|--------------------------------------|
| 30 V (upper display) | 0.001 V | 0.02 % + 2 |
| 20 V (lower display) | 0.001 V | 0.02 % + 2 |
| 90 mV | 0.01 mV | 0.02 % + 2 |
| Temperature coefficient -10 °C to 18 °C, +28 °C to 55 °C: ±0.005 % of range per °C | | |

DC Voltage Source

| Range | Resolution | Accuracy, (% of Reading + Counts) |
|---|------------|--------------------------------------|
| 100 mV | 0.01 mV | 0.02 % + 2 |
| 10 V | 0.001 V | 0.02 % + 2 |
| Temperature coefficient -10 °C to 18 °C, +28 °C to 55 °C: ±0.005 % of range per °C | | |
| Maximum load: 1 mA | | |

DC mA Measurement

| Range | Resolution | Accuracy, (% of Reading + Counts) |
|---|------------|--------------------------------------|
| 24 mA | 0.001 mA | 0.02 % + 2 |
| Temperature coefficient -10 °C to 18 °C, +28 °C to 55 °C: ±0.005 % of range per °C | | |
| Drive capability: 1000 Ω at 20 mA | | |

Ohms Measurement

| Ohms Range | Accuracy $\pm \Omega$ | |
|-----------------------|-----------------------|----------------|
| | 4-Wire | 2- and 3-Wire* |
| 0 to 400 Ω | 0.1 | 0.15 |
| 400 to 1.5 k Ω | 0.5 | 1.0 |
| 1.5 to 3.2 k Ω | 1 | 1.5 |

Excitation Current: 0.2 mA
Maximum input voltage: 30 V
Temperature coefficient -10 °C to 18 °C, +28 °C to 55 °C: ± 0.005 % of range per °C

* 2-wire: Does not include lead resistance.
 3-wire: Assumes matched leads with a total resistance not exceeding 100 Ω .

Ohms Source

| Ohms Range | Excitation Current from Measurement Device | Accuracy $\pm \Omega$ |
|-----------------------|--|-----------------------|
| 15 to 400 Ω | 0.15 to 0.5 mA | 0.15 |
| 15 to 400 Ω | 0.5 to 2 mA | 0.1 |
| 400 to 1.5 k Ω | 0.05 to 0.8 mA | 0.5 |
| 1.5 to 3.2 k Ω | 0.05 to 0.4 mA | 1 |

| Resolution | |
|-----------------------|--------------|
| 15 to 400 Ω | 0.1 Ω |
| 400 to 3.2 k Ω | 1 Ω |

Temperature coefficient -10 °C to 18 °C, +28 °C to 55 °C: ± 0.005 % of resistance range per °C

Millivolt Measurement and Source*

| Range | Resolution | Accuracy |
|---|------------|-----------------------------------|
| -10 mV to 75 mV | 0.01 mV | $\pm(0.025 \% + 1 \text{ count})$ |
| <p>Maximum input voltage: 30 V</p> <p>Temperature coefficient -10 °C to 18 °C, +28 °C to 55 °C: $\pm 0.005 \%$ of range per °C</p> <p>*Select this function by pressing <input type="checkbox"/> TC. The signal is available at the thermocouple miniplug connector.</p> | | |

Temperature, Thermocouples

| Type | Range | Measure and Source Accuracies (ITS-90) |
|------|--------------|--|
| J | -200 to 0 °C | 1.0 °C |
| | 0 to 1200 °C | 0.7 °C |
| K | -200 to 0 °C | 1.2 °C |
| | 0 to 1370 °C | 0.8 °C |
| T | -200 to 0 °C | 1.2 °C |
| | 0 to 400 °C | 0.8 °C |
| E | -200 to 0 °C | 0.9 °C |
| | 0 to 950 °C | 0.7 °C |

| | | |
|---|-----------------|---------|
| R | -20 to 0 °C | 2.5 °C |
| | 0 to 500 °C | 1.8 °C |
| | 500 to 1750 °C | 1.4 °C |
| S | -20 to 0 °C | 2.5 °C |
| | 0 to 500 °C | 1.8 °C |
| | 500 to 1750 °C | 1.5 °C |
| B | 600 to 800 °C | 2.2 °C |
| | 800 to 1000 °C | 1.8 °C |
| | 1000 to 1800 °C | 1.4 °C |
| L | -200 to 0 °C | 0.85 °C |
| | 0 to 900 °C | 0.7 °C |
| U | -200 to 0 °C | 1.1 °C |
| | 0 to 400 °C | 0.75 °C |
| N | -200 to 0 °C | 1.5 °C |
| | 0 to 1300 °C | 0.9 °C |
| <p>Resolution:</p> <p>J, K, T, E, L, N, U: 0.1 °C, 0.1 °F</p> <p>B, R, S: 1 °C, 1 °F</p> | | |

Temperature, RTD Ranges, and Accuracies (ITS-90)

| Type | Range °C | Accuracy | | |
|------------|--------------|-------------------|---------------------------|-----------|
| | | Measure 4-Wire °C | Measure 2- and 3-Wire* °C | Source °C |
| Ni120 | -80 to 260 | 0.2 | 0.3 | 0.2 |
| Pt100-385 | - 200 to 800 | 0.33 | 0.5 | 0.33 |
| Pt100-392 | -200 to 630 | 0.3 | 0.5 | 0.3 |
| Pt100-JIS | -200 to 630 | 0.3 | 0.5 | 0.3 |
| Pt200-385 | -200 to 250 | 0.2 | 0.3 | 0.2 |
| | 250 to 630 | 0.8 | 1.6 | 0.8 |
| Pt500-385 | -200 to 500 | 0.3 | 0.6 | 0.3 |
| | 500 to 630 | 0.4 | 0.9 | 0.4 |
| Pt1000-385 | -200 to 100 | 0.2 | 0.4 | 0.2 |
| | 100 to 630 | 0.2 | 0.5 | 0.2 |

Resolution: 0.1 °C, 0.1 °F

Allowable excitation current (source): Ni120, Pt100-385, Pt100-392, Pt100-JIS, Pt200-385: 0.15 to 3.0 mA
Pt500-385: 0.05 to 0.80 mA; Pt1000-385: 0.05 to 0.40 mA

RTD Source: Addresses pulsed transmitters and PLCs with pulses as short as 5 ms.

* 2-wire: Does not include lead resistance.

3-wire: Assumes matched leads with a total resistance not exceeding 100 Ω.

Loop Power Supply

Voltage: 24 V

Maximum current: 22 mA

Short circuit protected

General Specifications

| | |
|---|--|
| Operating temperature | -10 °C to 55 °C |
| Storage temperature | - 20 °C to 71 °C |
| Operating altitude | 3000 meters above mean sea level |
| Relative Humidity (% RH operating without condensation) | 90 % (10 to 30 °C) 75 % (30 to 40 °C) 45 % (40 to 50 °C) 35 % (50 to 55 °C) uncontrolled < 10 °C |
| Vibration | Random, 2 g, 5 to 500 Hz |
| Safety | EN 61010-1:1993, ANSI/ISA S82.01-1994; CAN/CSA C22.2 No 1010.1:1992 |
| Power requirements | 4 AA alkaline batteries |
| Size | 96 x 200 x 47 mm. (3.75 x 7.9 x 1.86 in) |
| Weight | 650 gm (1 lb, 7 oz) |

Index

—0—

0% output parameter, setting, 30

—1—

100% output parameter, setting, 30

—A—

Auto ramping output, 31

—B—

Batteries, replacing, 35

—C—

Calibration, 36

Cleaning calibrator, 36

—D—

Display, 13

—E—

Electrical parameters

measurement, 19

sourcing, 26

—G—

Getting started, 14

—I—

Input terminals, 8

Input/output terminals and connectors
(table), 9

—K—

Key functions (table), 11

Keys, 10

—M—

Measure functions, summary (table), 2

Measure mode, 17

Measuring

temperature with RTDs, 23

temperature with thermocouples, 20

—O—

Output device, testing, 34
Output terminals, 8

—P—

Parts list, 37

—R—

Recalling setups, 31
Repair, 36
RTD
 simulating, 27
RTD
 measuring, 23
 types, 23

—S—

Safety information, 3
Servicing, 36
Setup
 recalling, 31
 storing, 31
Thermocouple, 27
Simulating
 RTD, 27
 thermocouples, 27
Source functions, summary (table), 2
Sourcing
 electrical parameters, 26
 thermocouples, 27
Specifications, 39
Standard equipment, 3
Stepping output, 30

Storing setups, 31

—T—

Temperature
 measuring with RTD, 23
 measuring with thermocouple, 20
Terminals
 input, 8
 output, 8
Thermocouple
 measuring, 20
 measuring temperature, 20
 sourcing, 27
 types, 20
Transmitter, calibrating, 32