



FLUKE®

# i410/i1010

## AC/DC Current Clamp

### *Instructions*

Go to [www.fluke.com](http://www.fluke.com) to register your Product and find more information.

#### **Safety**

A **Warning** identifies conditions and procedures that are dangerous to the user. A **Caution** identifies conditions and procedures that can cause damage to the Product or the equipment under test.

⚠⚠ Warning

To prevent possible electrical shock, fire, or personal injury:

- **Carefully read all instructions.**
- **Read all safety information before you use the Product.**
- **Do not alter the Product and use only as specified, or the protection supplied by the Product can be compromised.**
- **Do not use the Product around explosive gas, vapor, or in damp or wet environments.**
- **Do not use the Product if it operates incorrectly.**
- **Use Product-approved measurement category (CAT), voltage, and amperage rated accessories (probes, test leads, and adapters) for all measurements.**
- **Do not exceed the Measurement Category (CAT) rating of the lowest rated individual component of a Product, probe, or accessory.**
- **Comply with local and national safety codes. Use personal protective equipment (approved rubber gloves, face protection, and flame-resistant clothes) to prevent shock and arc blast injury where hazardous live conductors are exposed.**
- **Before each use, examine the Product. Look for cracks or missing pieces of the clamp housing or output cable insulation. Also look for loose or weakened components. Carefully examine the insulation around the jaws.**
- **Do not use test leads if they are damaged. Examine the test leads for damaged insulation and measure a known voltage.**
- **Do not touch voltages >30 V ac rms, 42 V ac peak, or 60 V dc.**
- **Do not apply more than the rated voltage, between the terminals or between each terminal and earth ground.**

---













PN 617677 September 1996 Rev. 3, 8/20

©1996-2020 Fluke Corporation. All rights reserved. Specifications are subject to change without notification.

All product names are trademarks of their respective companies.

- Do not use a current measurement as an indication that a circuit is safe to touch. A voltage measurement is necessary to know if a circuit is hazardous.
- Limit operation to the specified measurement category, voltage, or amperage ratings.
- The battery door must be closed and locked before you operate the Product.
- Remove all probes, test leads, and accessories before the battery door is opened.
- Hold the Product behind the tactile barrier.
- Remove the input signals before you clean the Product.
- Repair the Product before use if the battery leaks. Battery leakage may create a shock hazard or damage the Product.
- Use only specified replacement parts.
- Have an approved technician repair the Product.
- Remove the batteries if the Product is not used for an extended period of time, or if stored in temperatures above 50 °C. If the batteries are not removed, battery leakage may result.
- Batteries contain hazardous chemicals that can cause burns or explode. If exposure to chemicals occurs, clean with water and get medical aid.
- Do not put battery cells and battery packs near heat or fire. Do not put in sunlight.

## Symbols

Symbol	Description
	WARNING. HAZARDOUS VOLTAGE. Risk of electric shock.
	WARNING. RISK OF DANGER.
	Consult user documentation.
	AC (Alternating Current)
	DC (Direct Current)
	Double Insulated
	Earth
	Application around and removal from uninsulated hazardous live conductors is permitted.
	Conforms to European Union directives.
	Certified by CSA Group to North American safety standards.
	Conforms to relevant Australian Safety and EMC standards.
<b>CAT III</b>	Measurement Category III is applicable to test and measuring circuits connected to the distribution part of the building's low-voltage MAINS installation.
	This product complies with the WEEE Directive marking requirements. The affixed label indicates that you must not discard this electrical/electronic product in domestic household waste. Product Category: With reference to the equipment types in the WEEE Directive Annex I, this product is classed as category 9 "Monitoring and Control Instrumentation" product. Do not dispose of this product as unsorted municipal waste.

## Features and Connections

See Table 1 for a list of features and connections.

**Table 1. Features and Connections**

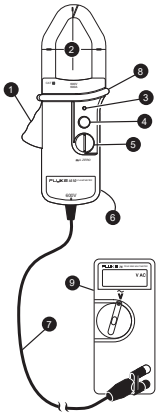
	Item	Description
	1	Jaw Lever
	2	Jaw Centering Marks
	3	ON Indicator
	4	ON/OFF Switch
	5	Zero Adjust
	6	Battery Access
	7	Output Cable
	8	Tactile Barrier
	9	Voltmeter <sup>[1]</sup>
<p>[1] Minimum voltmeter requirements:</p> <ul style="list-style-type: none"> <li>• Accepts safety-shrouded banana plugs</li> <li>• Can display 1 mV (0.1 mV preferred)</li> <li>• Accuracy <math>\geq 0.75\%</math></li> <li>• Input impedance <math>1\text{ M}\Omega, \leq 100\text{ pF}</math></li> </ul>		

## DC Current Measurement

See Table 2 for instructions on how to make a dc current measurement.

Note

Maximum 400 A dc rms (i410) or 1000 A dc rms (i1010).

**Table 2. DC Current Measurement**

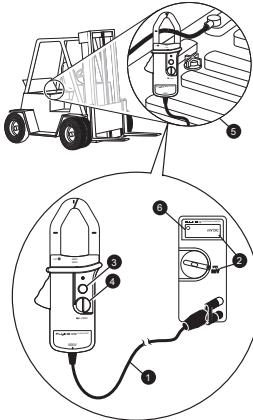
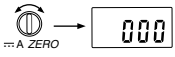
	Step	Description
	1	Connect to voltmeter.
	2	Select mV dc.
	3	Set to ON.
	4	Adjust ZERO (jaws empty). 
	5	Clamp and center around the conductor.
	6	Read voltmeter (1 mV = 1 A).

## AC Current Measurement

See Table 3 or instructions on how to make an ac current measurement.

Note

Maximum 400 A ac rms (i410) or 600 A ac rms (i1010).

Table 3. AC Current Measurement

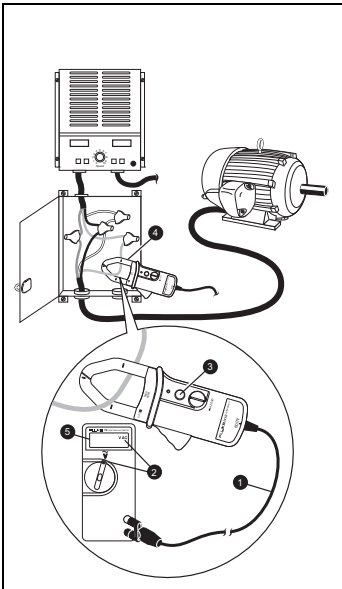
	Step	Description
	1	Connect to voltmeter.
	2	Select mV ac or V ac, but resolution may be limited to 1 A).
	3	Set to ON.
	4	Clamp and center around the conductor.
	5	Read voltmeter (1 mV = 1 A).

## Battery Test

To test the battery, see Table 4.

Table 4. Battery Test

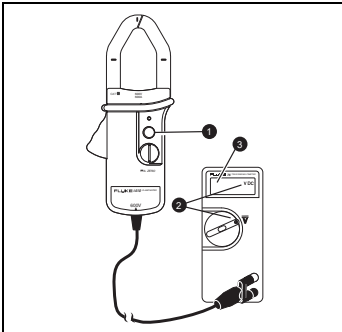
	Step	Instruction
	1	Set OFF.
	2	Select V dc.
	3	≤7.0 V dc = replace battery. (Voltmeter input impedance ≥1 MΩ)

## Battery Replacement

For specified battery life, use an alkaline battery. To replace the battery, see Figure 1.

Figure 1. Battery Replacement

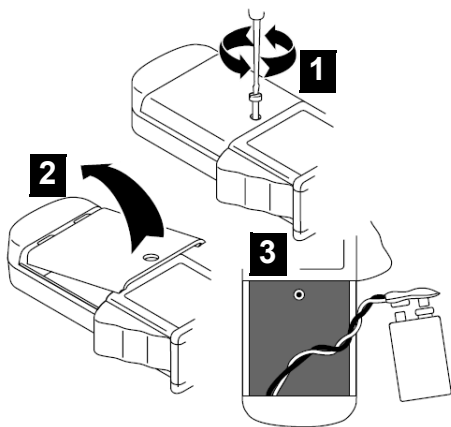

## If the Current Clamp Does Not Work

Check	Correction
Battery = OK?	See <i>Battery Test</i>
Voltmeter connections?	Red to + or Black to COM
Voltmeter function/range?	mV dc/mV ac (or V ac)

## Storage

During long periods of non-use (>60 days), remove and store the battery separately.

## Cleaning

Periodically wipe the case with a damp cloth and mild detergent. Do not use abrasives or solvents.

## Service and Parts

The Current Clamp should be serviced only by a qualified service technician. For service information, contact your nearest Fluke dealer or service center.

## Safety Specifications

Maximum voltage between any Terminal and Earth Ground.....600 V

### Temperature

Operating.....-10 °C to 50 °C

Storage.....-20 °C to 60 °C

Relative Humidity.....0 % to 90 % (10 °C to 30 °C)

0 % to 75 % (30 °C to 40 °C)

0 % to 45 % (40 °C to 50 °C)

Operating Altitude.....2000 m

Storage Altitude.....12 000 m

Battery Type.....9 V (alkaline) IEC 6LR61

Battery Life.....60 hr typical (continuous with alkaline)

Current x Hz Product.....≤240 000

Output Signal.....1 mV/amp dc or ac

### Maximum Conductor

Diameter.....1 ea: 30 mm

2 ea: 25 mm

**Load Impedance**.....  $\geq 1 \text{ M}\Omega \leq 100 \text{ pF}$

**Specified Current Range**

i410..... 1 A to 400 A ac rms/1 A to 400 A dc

i1010..... 1 A to 600 A ac rms/1 A to 1000 A dc

*Note*

*With a true-rms voltmeter, the minimum ac current is limited to the low end of the specified mV ac range.*

**Usable Current Range**

i410..... 0.5 A to 400 A

i1010..... 0.5 A to 1000 A dc

**DC Accuracy (zero adjusted, conductor centered)**

i410..... 3.5 % + 0.5 A (0 A to 400 A)

i1010..... 2.0 % + 0.5 A (0 A to 1000 A)

**AC Accuracy**

i410..... 3.5 % + 0.5 A, 45 Hz to 400 Hz

Crest Factor  $\leq 3$  (0 A to 400 A)

i1010..... 2.0 % + 0.5 A, 45 Hz to 400 Hz

Crest Factor  $\leq 3$  (0 A to 600 A)

**Bandwidth**

i410..... 3 kHz

i1010..... 10 kHz

**Temperature**

**Coefficient**.....  $\pm(0.05 \times \text{accuracy per } 0 \text{ }^\circ\text{C to } 18 \text{ }^\circ\text{C, } 28 \text{ }^\circ\text{C to } 50 \text{ }^\circ\text{C})$

**Size**..... 209 mm x 78 mm x 48 mm

**Weight**..... 0.5 kg

**Safety**..... IEC 61010-1, Pollution Degree 2  
IEC 61010-2-032: CAT III 600 V

**Electromagnetic Compatibility (EMC)**

International..... IEC 61326-1: Portable, Electromagnetic Environment, IEC 61326-2-2  
CISPR 11: Group 1, Class A,

*Group 1: Equipment has intentionally generated and/or uses conductively-coupled radio frequency energy that is necessary for the internal function of the equipment itself.*

*Class A: Equipment is suitable for use in all establishments other than domestic and those directly connected to a low-voltage power supply network that supplies buildings used for domestic purposes. There may be potential difficulties in ensuring electromagnetic compatibility in other environments due to conducted and radiated disturbances.*

*Caution: This equipment is not intended for use in residential environments and may not provide adequate protection to radio reception in such environments.*

Korea (KCC)..... Class A equipment (Industrial Broadcast & Communications Equipment)

*Class A: Equipment meets requirements for industrial electromagnetic wave equipment and the seller or user should take notice of it. This equipment is intended for use in business environments and not to be used in homes.*

USA (FCC)..... 47 CFR 15 subpart B. This product is considered an exempt device per clause 15.103.

## LIMITED WARRANTY AND LIMITATION OF LIABILITY

This Fluke product will be free from defects in material and workmanship for one year from the date of purchase. This warranty does not cover fuses, disposable batteries, or damage from accident, neglect, misuse, alteration, contamination, or abnormal conditions of operation or handling. Resellers are not authorized to extend any other warranty on Fluke's behalf. To obtain service during the warranty period, contact your nearest Fluke authorized service center to obtain return authorization information, then send the product to that Service Center with a description of the problem.

THIS WARRANTY IS YOUR ONLY REMEDY. NO OTHER WARRANTIES, SUCH AS FITNESS FOR A PARTICULAR PURPOSE, ARE EXPRESSED OR IMPLIED. FLUKE IS NOT LIABLE FOR ANY SPECIAL, INDIRECT, INCIDENTAL OR CONSEQUENTIAL DAMAGES OR LOSSES, ARISING FROM ANY CAUSE OR THEORY. Since some states or countries do not allow the exclusion or limitation of an implied warranty or of incidental or consequential damages, this limitation of liability may not apply to you.

11/99