



Table of contents:

1. SAFETY PRECAUTIONS AND PROCEDURES 2
1.1. Preliminary instructions 2
1.2. During use 3
1.3. After use 3
1.4. Overvoltage categories - Definitions 3
2. GENERAL DESCRIPTION 4
2.1. Introduction 4
2.2. Instrument features 4
3. PREPARATION FOR USE 5
3.1. Initial checks 5
3.2. Instrument power supply 5
3.3. Calibration 5
3.4. Storage 5
4. DESCRIPTION OF PARTS 6
4.1. Instrument description 6
4.2. Keyboard description 7
4.3. Display description 7
4.4. Initial screen 7
5. MAIN MENU 8
5.1. SET - Instrument settings 8
5.1.1. Language / AutopowerOFF / Contrast 8
5.1.2. Measurement units 9
5.1.3. Date/Time 9
5.1.4. Solar meter 10
5.1.5. Irradiance 10
5.2. DB - Module database 11
5.2.1. How to define a new PV module 12
5.2.2. How to modify a PV module 13
5.2.3. How to delete a PV module 13
6. HOW TO OPERATE 14
6.1. Introduction 14
6.1.1. Theoretical aspects of the I-V curve measurement 14
6.1.2. Theoretical aspects of Rs measurement 14
6.2. I-V curve measurement 15
6.2.1. Meaning of measurement results 18
6.3. Serial resistance Rs 19
6.3.1. Serial resistance Rs measurement 19
6.4. List of display messages 22
7. STORING DATA 23
7.1. Saving I-V curve test results 23
7.2. Managing the results 23
7.2.1. Recall data 23
7.2.2. Delete data 24
7.2.3. View data - Numerical screens 24
7.2.4. View data - Graphic screens of I-V curve 26
7.2.5. View data - Graphic screens of power 27
8. CONNECTING THE INSTRUMENT TO A PC 28
9. MAINTENANCE 29
9.1. General 29
9.2. Battery replacement 29
9.3. Instrument cleaning 29
9.4. End of life 29
10. TECHNICAL SPECIFICATIONS 30
10.1. Technical feratures 30
10.2. Safety specificationS 30
10.2.1. General 30
10.3. General characteristics 30
10.4. ENVIRONMENT 31
10.5. Accessories 31
11. SERVICE 32
11.1. Warranty conditions 32
11.2. Service 32

1. SAFETY PRECAUTIONS AND PROCEDURES

This instrument has been designed in compliance with directives IEC/EN61010-1 regarding electronic measuring instruments. Before and while measuring, carefully follow the instructions below:

- Do not perform voltage or current measurements in humid environments
- Do not perform measurements near explosive gas or material and fuels or in dusty environments
- Avoid contact with the circuit tested if no measurement is being performed
- Avoid contact with exposed metal parts, test terminals not in use, circuits, etc.
- Do not perform any measurement if instrument anomalies are detected, such as deformations, breaks, leakage of substances, no display reading, etc.
- Only use original HT accessories

In this manual, following symbols are used:



CAUTION: Follow the instructions given in this manual; improper use may damage the instrument, its components or create dangerous situations for the operator



High voltage: risk of electrical shock



Double insulation



DC voltage or current



AC voltage or current



Ground reference

1.1. PRELIMINARY INSTRUCTIONS



- This instrument has been designed for use in the environmental conditions specified in section 10.3. Do not use in different environmental conditions.
- The instrument may be used for measuring of **VOLTAGE** and **CURRENT** in CAT II 1000V DC or CAT III 300V to ground. Do not use on systems exceeding the limit values specified in section 10.1.
- We recommend to follow the ordinary safety rules aimed at: your protection against dangerous currents, the instrument's protection against improper use.
- Only the accessories provided with the instrument guarantee compliance with safety standards. They must be in good conditions and must be replaced, if necessary, with identical models.
- Check that batteries are correctly inserted.
- Before connecting the test cables to the circuit being tested, check that the desired function has been selected.

1.2. DURING USE

We recommend to carefully read the following recommendations and instructions:



CAUTION

- Failure to comply with the CAUTIONs and/or instructions may damage the instrument and/or its components or cause dangers to the operator.
- The symbol “” indicates the charge level. When there are five bars, it means that batteries are fully charged; a decrease in the number of bars down to “” indicates that the batteries are almost low. In this case, interrupt tests and replace the batteries according to the indications given in section 9.2. **The instrument is capable of keeping data stored even without batteries.**

1.3. AFTER USE

When measuring operations are completed, turn off the instrument by pressing and holding the ON/OFF key for a few seconds. Should the instrument remain unused for a long time, remove batteries and follow the indications given in section 3.4.

1.4. OVERVOLTAGE CATEGORIES - DEFINITIONS

Standard EN61010-1 (Safety requirements for electrical equipment for measurement, control and laboratory use, Part 1: General requirements) defines what a measurement category (usually called “overvoltage category”) is. At paragraph 6.7.4: Measuring circuits it quotes:

circuits are divided into the following measurement categories:

- **Measurement category IV** is for measurements performed at the source of the low-voltage installation.
Examples are electricity meters and measurements on primary overcurrent protection devices and ripple control units.
- **Measurement category III** is for measurements performed in the building installation.
Examples are measurements on distribution boards, circuit breakers, wiring, including cables, bus-bars, junction boxes, switches, socket-outlets in the fixed installation, and equipment for industrial use and some other equipment, for example, stationary motors with permanent connection to fixed installation.
- **Measurement category II** is for measurements performed on circuits directly connected to the low voltage installation.
Examples are measurements on household appliances, portable tools and similar equipment.
- **Measurement category I** is for measurements performed on circuits not directly connected to MAINS.
Examples are measurements on circuits not derived from MAINS, and specially protected (internal) MAINS-derived circuits. In the latter case, transient stresses are variable; for that reason, the norm requires that the transient withstand capability of the equipment is made known to the user.

2. GENERAL DESCRIPTION

2.1. INTRODUCTION

The instrument you purchased was designed to perform all I-V curve tests on single modules (panels) or complete strings of photovoltaic (PV) plants in order to verify the reference parameters given by the manufacturers. Therefore, the meter is an ideal solution for troubleshooting any PV installation.

2.2. INSTRUMENT FEATURES

The instrument can perform the following tests:

- Output voltage measurement of PV module/string up to 1000V DC
- Output current measurement of PV module/string up to 10A DC
- PV module/string temperature measurement
- Irradiance measurement [W/m^2] by using reference cell
- DC output max power measurement of PV module/string
- Evaluation of solar incidence angle on module with mechanical inclinometer
- Numerical and graphical results of I-V curve with 4-wire method
- Comparison of results with standard conditions (STC) and OK/NO final response
- Panel serial resistance measurement
- Internal customizable database for definition up to 30 PV modules
- Internal memory for saving test
- Optical/USB interface for PC connection

I-V 400 meter has an innovative electronic function selector to simply set operations with internal parameters, a backlight display, the contrast adjustment and a **HELP** key in order to give a valid help to the operator during the meter's connection to the plants.

An enable/disable AutoPowerOFF feature is available after about 5 minutes of idleness.

On the back of meter you can find also the herewith scheme (see Fig. 1) which can help the operator during the connection on installation before starting tests.

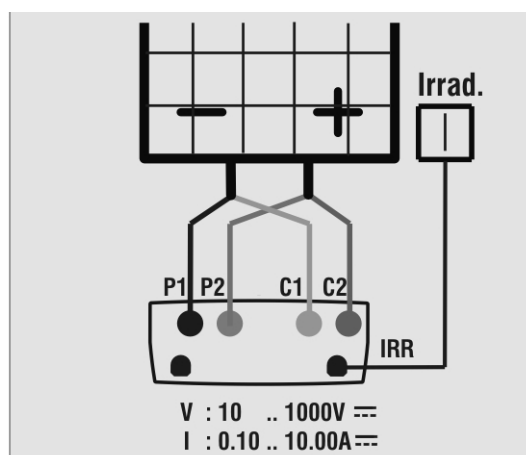

Fig. 1: Synoptic scheme label on the back of the meter

3. PREPARATION FOR USE



3.1. INITIAL CHECKS

Before shipment, the instrument's electronics and mechanics have been carefully checked. All possible precautions have been taken to have the instrument delivered under optimal conditions. However, we recommend to rapidly check the instrument in order to detect possible damage occurred during transport. Should you detect anomalies, please immediately contact the dealer.

It is also recommended to check that the package contains all parts indicated in section 10.5. In case of discrepancies, please contact the dealer. Should it be necessary to return the instrument, please follow the instructions given in section 11.

3.2. INSTRUMENT POWER SUPPLY

The instrument is battery supplied. For battery type and life, see section 10.3.

The symbol "" indicates the charge level. When there are five bars next to the battery symbol, it means that batteries are fully charged; a decrease in the number of bars down to "" indicates that the batteries are almost low. In this case, interrupt tests and replace the batteries according to the indications given in section 9.2.

The instrument is capable of keeping data stored even without batteries.

The instrument is provided with advanced algorithms to maximize the batteries' life. In particular:

- The instrument automatically turns off the display's back lighting after approx. 5 seconds.
- In order to increase battery life, should the voltage supplied by batteries be too low, the instrument disables the display's back-lighting function.

During instrument operation, a further short pressing of the  key turns on the display's backlighting (if battery voltage level is high enough). In order to save battery efficiency, backlighting automatically turns off after approx. 20 seconds.

A frequent use of back lighting reduces the batteries' life

3.3. CALIBRATION

The instrument's technical specifications are those described in this manual. Its performance is warranted for one year (12 months) from the date of purchase.

3.4. STORAGE

In order to guarantee precise measurements, after a long period of the instrument's storage under extreme environmental conditions, wait until it recovers its normal conditions (see the environmental specifications listed in section 10.3).

4. DESCRIPTION OF PARTS

4.1. INSTRUMENT DESCRIPTION

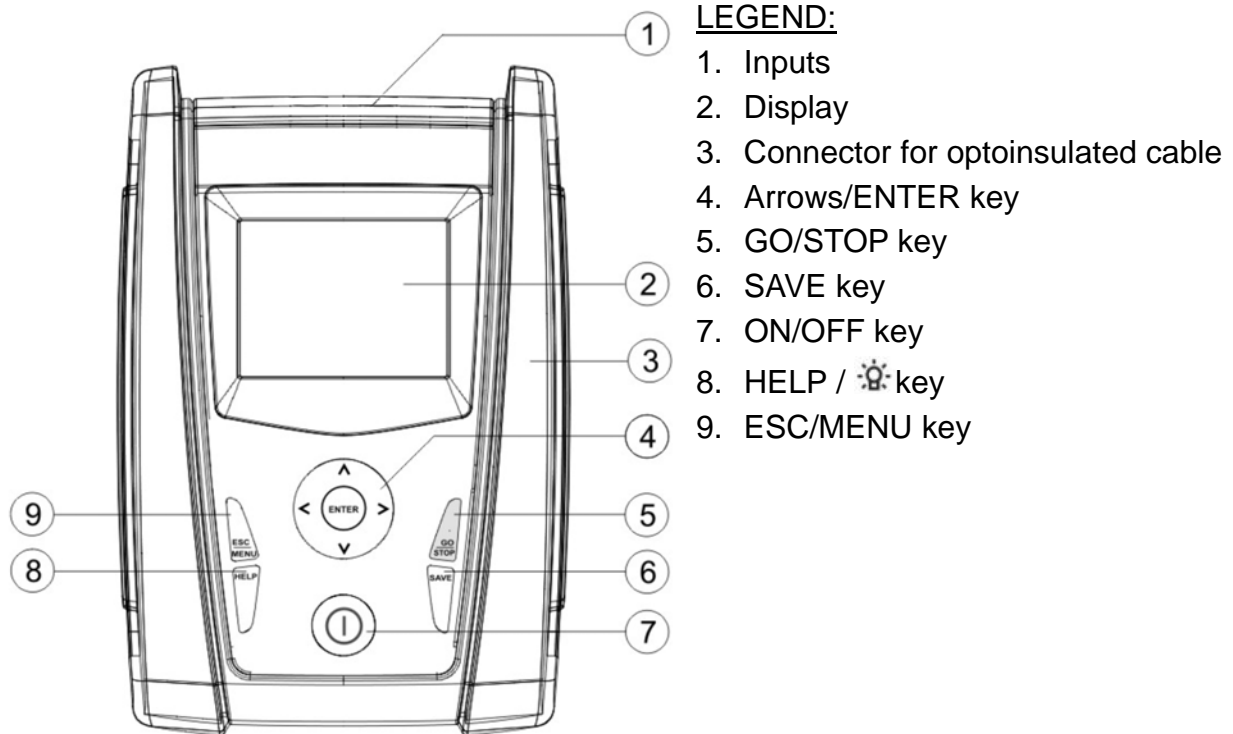

Fig. 2: Description of the front part of the instrument

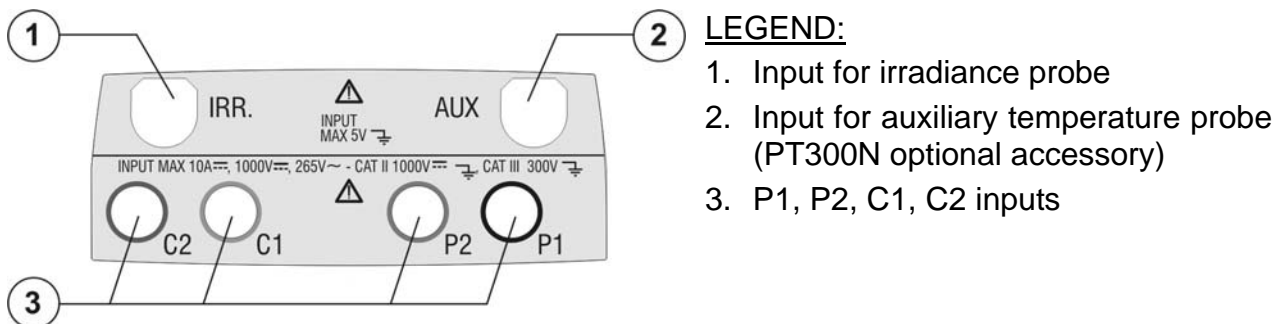

Fig. 3: Description of the upper part of the instrument

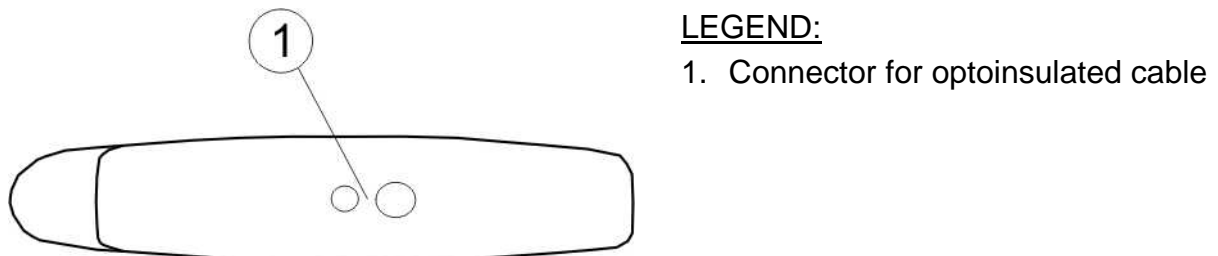

Fig. 4: Description of the instrument's side

4.2. KEYBOARD DESCRIPTION

The keyboard includes following keys:



ON/OFF key to switch on/off the instrument



ESC/MENU key to exit the selected menu without confirming and to activate menu management



◀ ▶ ▲ ▼ keys to move the cursor through the different screens in order to select the desired programming parameters

ENTER key to confirm the modifications and the selected programming parameters and to select the function from the menu



GO/STOP key to start measurements



SAVE key to save the measured values



HELP key (long pressure) to display an indicative outline of the connections between the instrument and the system being tested in the function set

☀ key (short pressure) to turn on the display's backlighting

4.3. DISPLAY DESCRIPTION

The display is a graphic module with a resolution of 128 x 128 dots. The display's first line indicates the system date/hour and the battery charge indicator.

15/06/09	15:34:26	
V_{dc}	=	0.0 V
I_{rr}	=	0 W/m²
T_c	= - - -	°C
Module: SUNPOWER 210		
Selection	I - V	

4.4. INITIAL SCREEN

When turning on the instrument, the instrument displays the initial screen for a few seconds. It displays the following:

- The instrument's model
- The manufacturer's name
- The serial number (SN:) of the instrument
- The firmware version (FW:) in the instrument's memory
- The date of the last calibration (Calibration date:)

I-V
400
HT ITALIA
SN: 12345678
FW: 1.00
Calibration date: 01/07/2008

Then, the instrument switches to the last function selected.

5. MAIN MENU

Pressing the **MENU/ESC** key in any allowable condition of the instrument displays the main menu screen, in which the instrument may be set, the saved measures can be displayed and the desired measuring function may be set.

Select by cursor the desired options and confirm by pressing **ENTER**.

15/06/09 15:34:26	
I-V I-V Test	
SET	Settings
DB	Modules
MEM	Data Recall
PC	PC connections
ENTER to select	
MENU	

5.1. SET – INSTRUMENT SETTINGS

Move the cursor to **SET** by means of the arrow keys (**▲**, **▼**) and confirm with **ENTER**. Subsequently, the displays shows the screen which provides access to the various instrument's settings.

The settings will remain valid also after switching off the instrument

15/06/09 15:34:26	
General	
Meas. Units	
Date and Time	
Solarmeter	
Irradiance	
ENTER to select	
MENU	

5.1.1. Language / AutopowerOFF / Contrast

1. Move the cursor to "**General**" by means of the arrow keys (**▲**, **▼**) and confirm with **ENTER**
2. The displays shows the screen which allows setting the instrument language, the enable/disable of autopower off and the contrast adjustment of display
3. Move the cursor to "**Language**" by means of the arrow keys (**▲**, **▼**) and select the desired option by means of the arrow keys (**◀**, **▶**)
4. Perform the same operation also for the other items.
5. Confirm with **SAVE** and the "Data saved" message is displayed for a while. Press the **ESC/MENU** key to exit without saving and to go back to the previous screen

15/06/09 15:34:26	
Language :◀ English ▶	
Autopoweroff :NO	
Contrast :10	
SAVE to store data	
SET	

5.1.2. Measurement units

This section allows setting the default measurement units of some internal parameters included in the database (DB) for the management of PV modules (§ 5.2)

1. Move the cursor to "**Meas. Unit**" by means of the arrow keys (▲, ▼) and confirm with **ENTER**.
2. The display shows the screen which allows selecting the measurement units of parameters shown by the meter.
3. Press **ESC/MENU** to exit without saving any setting.

15/06/09 15:34:26	
Parameter	
ENTER to select	
	MENU

4. Move the cursor to "**Parameter**" by means of the arrow keys (▲, ▼) and confirm with **ENTER**.
5. The display shows the screen which allows selecting the measurement units of typical parameters of the modules:
 - Alpha → possible selection: "%/°C" and "mA/°C"
 - Beta → possible selection: "%/°C" and "mV/°C"
 - Gamma → possible selection: "%/°C" and "W/°C"
 - Tolerance → possible selection: "%" and "W"
6. Set the desired units by means of the arrow keys (◀, ▶).
7. Confirm with **SAVE** and the "Saved data" message is displayed for a while. Press **ESC/MENU** key to exit without saving and to go back to the previous screen.

15/06/09 15:34:26	
Alpha	: ◀ mA/°C ▶
Beta	: mV/°C
Gamma	: W/°C
Tolerance	: %
SAVE to store data	
	SET

5.1.3. Date/Time

1. Move the cursor to "**Date/Time**" by means of the arrow keys (▲, ▼) and confirm with **ENTER**
2. The display shows the screen which allows setting the system date/time both in the **European (EU)** or **USA (US)** format.
3. Set the values by means of the arrow keys (◀, ▶).
4. Confirm with **SAVE** and the "Saved data" message is displayed for a while. Press **ESC/MENU** key to exit without saving and to go back to the previous screen.

15/06/09 15:34:26	
Year	: ◀ 2009 ▶
Month	: 06
Day	: 15
Hour	: 09
Minute	: 53
Format	: EU
SAVE to store data	
	SET

5.1.4. Solar meter

This section allows setting the values of typical parameters (Sensitivity and Alpha) of the reference irradiance cell HT304 supplied with the meter. **The values of these parameters, which are printed on the back label of the cell, depend on the MONOcrystal or MULTICrystal type of PV modules.**

1. Move the cursor to “**Solarmeter**” by means of the arrow keys (▲,▼) and confirm with **ENTER**.
2. The display shows the screen which allows setting the sensitivity of the reference cell supplied, expressed in “mV/kW*m⁻²”.
3. Set the value by means of the arrow keys (◀,▶).
4. Confirm with **SAVE** and the “Saved data” message is displayed for a while. Press **ESC/MENU** key to exit without saving and to go back to the previous screen.

15/06/09 15:34:26	
Sens. : ◀ 31.0 ▶ mV/kW/m2	
Alpha : 0.060 %/°C	
SAVE to store data	
	SET

5.1.5. Irradiance

1. Move the cursor to “**Irradiance**” by means of the arrow keys (▲,▼) and confirm with **ENTER**.
2. The display shows the screen which allows setting the minimum threshold of measured irradiance expressed in W/m², used by meter as reference during the measurements.
3. Set the value by means of the arrow keys (◀,▶). The accuracy indicated in this manual is granted under condition indicated in § 10.1.
4. Confirm with **SAVE** and the “Saved data” message is displayed for a while. Press **ESC/MENU** key to exit without saving and to go back to the previous screen.

15/06/09 15:34:26	
Min. Irrad. : ◀ 600 ▶ W/m2	
SAVE to store data	
	SET

5.2. DB – MODULE DATABASE

The I-V 400 meter allows performing a preliminary selection of the intrinsic parameters relative to a PV module, which can be saved in an internal customizable database by setting the values and the associated name. These modules can be recalled, modified and erased at any moment.

The meter allows defining **up to 30 different PV modules**, further to a DEFAULT situation (not editable and not erasable) which can be used as reference case when no piece of information about the module under test is available.

The parameters which can be set, **with reference to 1 module**, are described below in Table 1 together with their range, resolution and validity condition.

Symbol	Description	Range	Resolution	Condition
Nms	Number of modules for string	1 ÷ 50	1	
Pmax	Maximum nominal power of module	50 ÷ 999W	1W	$\left \frac{P_{\max} - V_{mpp} \cdot I_{mpp}}{P_{\max}} \right \leq 0.01$
Voc	Open voltage	15.00 ÷ 99.99V	0.01V	$V_{oc} \geq V_{mpp}$
Vmpp	Voltage on point of maximum power	15.00 ÷ 99.99V	0.01V	$V_{oc} \geq V_{mpp}$
Isc	Short circuit current	0.5 ÷ 9.99A	0.01A	$I_{sc} \geq I_{mpp}$
Impp	Current on point of maximum power	0.5 ÷ 9.99A	0.01A	$I_{sc} \geq I_{mpp}$
Toll -	Negative tolerance provided by manufacturer	0% ÷ 25.0%	0.1%	$100 \cdot \text{Tol}^- / P_{nom} < 25$
		0 ÷ 99W	1	
Toll +	Positive tolerance provided by manufacturer	0 ÷ 25%	0.1%	$100 \cdot \text{Tol}^+ / P_{nom} < 25$
		0 ÷ 99W	1	
Alpha	Isc temperature coefficient	0.001 ÷ 0.100%/°C	0.001%/°C	$0.1 \cdot \text{Alpha} / I_{sc} \leq 0.1$
		0.01 ÷ 9.99mA/°C	0.01mA/°C	
Beta	Voc temperature coefficient	-0.99 ÷ -0.01%/°C	0.01%/°C	$100 \cdot \text{Beta} / V_{oc} \leq 0.999$
		-0.999 ÷ 0.001V/°C	0.001V/°C	
Gamma	Pmax temperature coefficient	-0.99 ÷ -0.01%/°C	0.01%/°C	
NOCT	Nominal working temperature of cell	0 ÷ 100°C	1°C	
K	Correction factor of curve	0.00 ÷ 10.00mΩ/°C	0.01 mΩ/°C	
Rs	Internal serial resistance	0.00 ÷ 10.00Ω	0.01Ω	

Table 1: Typical parameters of PV modules

5.2.1. How to define a new PV module

- Move the cursor to “DB” by means of the arrow keys (▲, ▼) and confirm with **ENTER**. The display shows the screen with:
 - The type of selected module
 - The parameter associated to the module (see Table 1)
- Select the “DEFAULT” module by means of the arrow keys (◀, ▶) and confirm with **ENTER**.

15/06/09 15:34:26	
Type : ◀ DEFAULT ▶	
▲	
P max	= 185 W
V oc	= 44.5 V
V mpp	= 37.5 V
I sc	= 5.40 A
I mpp	= 4.95 A
T oll-	= 0 %
▼	
Select	DB

- Press **ENTER**, select the “New” command and confirm again with **ENTER**. Use the arrow keys (▲, ▼) to scroll all internal parameters.

15/06/09 15:34:26	
Type : ◀ DEFAULT ▶	
▲	
P max	= 185 W
V oc	= 44.5 V
V mpp	= 37.5 V
I sc	= 5.40 A
I mpp	= 4.95 A
T oll-	= 0 %
▼	
New	
Select	DB

- By using the internal virtual keyboard it is possible to define the name of the module (ex: SUNPOWER 210) by means the arrow keys (▲, ▼, ◀, ▶). Press **ENTER** to digit the characters of the desired name.
- Press the **SAVE** key to save the inserted name of the module as defined or **ESC/MENU** key to exit without saving.

15/06/09 15:34:26	
Type :	
▲	
P max	= 185 W
V oc	= 44.5 V
KEYBOARD	
SUNPOWER 210	
A B C D E F G H I J K L M N O P	
Q R S T U V W X Y Z - + 0 1 2 3	
4 5 6 7 8 9 SPACE DEL	

- Digit the value of each parameter of the defined module (see Table 1) based on the manufacturer's data sheet. Move the cursor to the row of the parameter by means of the arrow keys (▲, ▼) and set the value by means of the arrow keys (◀, ▶). Press and hold (◀, ▶) for a quick setting of values. If the value of any parameter is unknown, press and hold the **HELP** key for some seconds to set the default values.
- Confirm with **SAVE** and the “Saved data” message is displayed for a while. Press **ESC/MENU** key to exit without saving and to go back to the previous screen.

15/06/09 15:34:26	
Type : SUNPOWER 210	
▲	
P max	= ◀ 0 ▶ W
V oc	= 0.0 V
V mpp	= 0.0 V
I sc	= 0.00 A
I mpp	= 0.00 A
T oll-	= 0 %
▼	
Select	DB



CAUTION

After pressing the **SAVE** key, the meter checks all the conditions shown in Table 1 and, if one or more of these conditions do not occur, some error messages are shown by the display (§ 6.4) and the meter does not save the configuration before any error is solved. Solve the error condition before saving.

5.2.2. How to modify a PV module

1. Select the PV module to be modified from the internal database by means of arrow keys (◀,▶).
2. Press the **ENTER** key and select the “**Modify**” command by means the arrow key (▼).
3. Confirm the selection with **ENTER**.

15/06/09 15:34:26	
Type: ◀ SUNPOWER210 ▶	
▲	
P max	= 210 W
V oc	= 47.70 V
V mpp	= 40.00 V
I sc	= 5.75 A
New	
Modify	
Delete	
Del. All	
Select	DB

4. By using the internal virtual keyboard it is possible to define a different name of the module by means of arrow keys (▲,▼,◀,▶). Press **ENTER** to digit any character of the desired name.
5. Press the **SAVE** key to save the new name of the module as defined or to access the new setting of parameters.

15/06/09 15:34:26	
Type: ◀ SUNPOWER210 ▶	
▲	
P max	= 185 W
V oc	= 44.5 V
KEYBOARD	
SUNPOWER 210	
A B C D E F G H I J K L M N O P	
Q R S T U V W X Y Z - + 0 1 2 3	
4 5 6 7 8 9 SPACE DEL	
SAVE/ESC	

6. Select the desired parameters to be modified by means of arrow keys (▲,▼) and change values by means of arrow keys (◀,▶). Press and hold the (◀,▶) for a quick setting of values. If the value of any parameter is unknown, press and hold the **HELP** key for some seconds to set the default values.
7. Confirm with **SAVE** and the “Saved data” message is displayed for a while. Press **ESC/MENU** key to exit without saving and to go back to the previous screen.

15/06/09 15:34:26	
Type : SUNPOWER 210	
▲	
P max	= ◀ 210 ▶ W
V oc	= 47.70 V
V mpp	= 40.00 V
I sc	= 5.75 A
I mpp	= 5.25 A
T oll-	= 5 %
▼	
DB	

5.2.3. How to delete a PV module

1. Select the PV module to be deleted from the internal database by means of arrow keys (◀,▶).
2. Press **ENTER** key and select “**Delete**” command by means of arrow key (▼) to delete the selected module.
3. Press the **ENTER** key and select “**Del. All**” command by means of arrow key (▼) to delete all modules in the database (except for “DEFAULT”).
4. Confirm the selection with **ENTER** or press **ESC/MENU** to exit the section.

15/06/09 15:34:26	
Type: ◀ SUNPOWER210 ▶	
▲	
P max	= 210 W
V oc	= 47.70 V
V mpp	= 40.00 V
I sc	= 5.75 A
New	
Modify	
Delete	
Del. All	
Select	DB



CAUTION

It is not possible to modify or delete the “DEFAULT” PV module which is the standard reference factory module.

6. HOW TO OPERATE

6.1. INTRODUCTION

The I-V 400 meter is designed to perform test and measurements on **PV modules (or panels)**, composed by a suitable number of **PV cells**, in order to detect their I-V characteristic (Current-Voltage) and their serial resistance R_s , which are typical parameters relative to their performance, based upon an IEC/EN60891 reference standard.

The meter can perform tests both on single PV modules and on **PV string** (a composition of more PV modules) which are normally the main parts of a single-phase or three-phase photovoltaic installation.

6.1.1. Theoretical aspects of the I-V curve measurement

The I-V curve test is performed as described below:

- The meter performs the I-V curve measurement of the PV panel connected to it, futher to the real time measurement of irradiance and module temperature
- The results of measurements are automatically “translated” to the standard conditions (STC) of irradiance at **1000 W/m²** and module temperature at **25°C**. The accuracy indicated in this manual is granted under condition indicated in § 10.1.
- The meter performs a comparison between the maximum nominal power, with the margin of percentage tolerance declared by the module’s manufacturer, which is included in the kind of module selected on the meter from the database (§ 5.2.1), and the measured value
- If the comparison of power is within the declared tolerance, the final response of the meter will be “OK” or will be “NO OK” in the opposite case, and the module will not be complying with the specifications declared by the manufacturer (§ 6.2.1)

6.1.2. Theoretical aspects of R_s measurement

The test about serial resistance R_s is used in order to perform an exact measurement in real time of this parameter and then add this value to the definition of the PV module’s specifications in the internal database of the meter, in compliance with the IEC/EN60891 standard.

6.2. I-V CURVE MEASUREMENT



CAUTION

The maximum voltage among P1, P2, C1, and C2 inputs is 1000V DC. Do not measure voltages exceeding the limits prescribed by this manual. Should you exceed the voltage limits you could damage the instrument and/or its components or endanger your safety.

- Turn on the meter by pressing **ON/OFF** key
- The instrument displays a screen similar to the one reported here to the side, where:
 - Vdc = DC output voltage from panel measured between C1 and C2 inputs of meter
 - Irr = irradiance measured by supplied reference cell
 - Tc = cell temperature measured by supplied probe
 - Module = last type of used module included in internal database
 - Temp = measurement mode of module temperature.

15/06/09 15:34:26	
Vdc = 0.0 V	
Irr = - - - W/m2	
Tc = - - - °C	
Module: PANEL01	
Temp: Aux	
Select	I - V

- Press **ENTER** key, select the “**Settings**” item and confirm again with **ENTER** to access the next screen which allows setting the type of PV module and the number of modules relative to the PV string under test.

15/06/09 15:34:26	
Vdc = 0.0 V	
Irr = - - - W/m2	
Tc = - - - °C	
Module: PANEL01	
Settings	
Meas. Type ▶	
Select	I - V

- By means of arrow keys (◀,▶) select the type of PV module included in the database of meter (§ 5.2.1).
- By means of arrow keys (▲,▼) select the item “N. of Mod.” and by means of arrow keys (◀,▶) set the number of modules of the PV string under test. The maximum number of modules is **50**
- By means of arrow keys (▲,▼) select the “Rs” item and by means of arrow keys (◀,▶) choose the “Manual” or “Auto” mode for the serial resistance measurement (§ 6.3)
- By means of arrow keys (◀,▶) select the type of PV module included in the database of meter (§ 5.2.1). By means of arrow keys (▲,▼) select the “Temp” item and by means of arrow keys (◀,▶) choose the type of module temperature among the modes listed:

15/06/09 15:34:26	
Type : ◀ SUNPOWER 210 ▶	
N.of Mod. : 15	
Rs : Auto	
Temp : Manual	
Value : 51°C	
Pmax = 210	
Voc = 47.70	
Vmpp = 40.00	
Isc = 5.75	
Imp = 5.25	
	SET

- **Auto** → automatic measurement performed by the meter depending on the measured value of open voltage
- **Manual** → setting of a module temperature value by the operator on the corresponding “**Value**” field
- **Aux** → setting of temperature of module performed by auxiliary (optional) probe

- Confirm with **SAVE** key or press **ESC/MENU** key to exit without saving.

9. Check the specifications of the reference cell HT304 (parameters Alpha and Sens.) on the meter according to the type of module **MONO**crystal or **MULTI**crystal under test (§ 5.1.4).
10. Check the minimum irradiance threshold set on meter (§ 5.1.5). It is recommended to perform measurements with threshold $\geq 700 \text{ W/m}^2$ in compliance with IEC/EN60891 standard.
11. Mount the M304 (inclinometer) supplied accessory, place and hold it on the plane of module. **Verify that the sun shadow falls on the disc within the “limit internal circle” on the disc itself (Fig. 6). If this is not the case, the incidence angle between sun rays and the module surface is too high and not complying with the test conditions declared by the module manufacturer. As a consequence the measurements performed by the meter are not ok and all measurements steps shall be repeated at another daytime.**
12. Connect the MONO or MULTI output (depending on the type of module under test) of reference cell at the **IRR.** input of meter by using the cable supplied with the cell.
13. Fix the support of the cell to the module by using the supplied set of screws and mount the HT304 reference cell on it possibly with **output terminals downwards with respect to the module**. Rotate the cell upwards to lean it on the small wing of the support so as the cell is perfectly parallel to the plane of module, then fix it with the relevant screws supplied.
14. Connect, if used, the auxiliary temperature probe PT300N (optional accessory) to the **AUX** input of meter and on the rear of module, fixing it with adhesive tape.
15. Connect the meter to the module/string under test as shown in Fig. 5. In particular, connect the negative output pole to P1, C1 input terminals and the positive output pole to P2, C2 input terminals

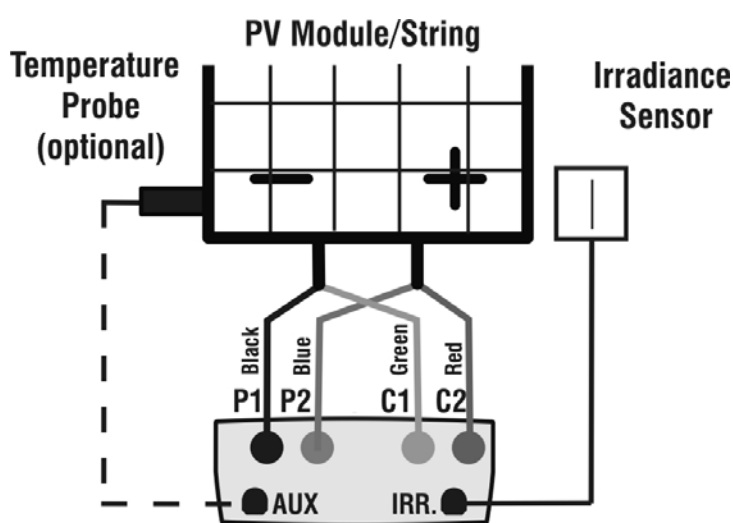

Fig. 5: Connection of meter to PV module/string

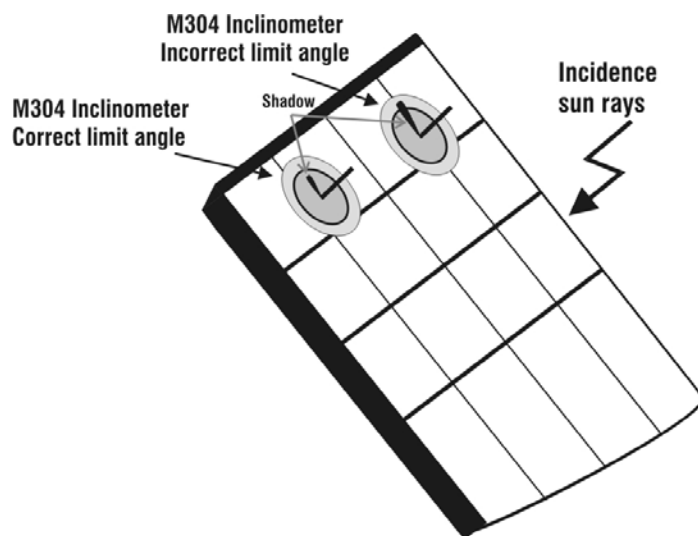

Fig. 6: Positioning the M304 inclinometer

CAUTION



The method used by I-V 400 for output VDC and IDC measurements of PV module/string is the “4-wire”. Therefore, it is possible to use also test cables connected to P1, C1, P2, C2 inputs of different length without performing any calibration of cable resistance. **It is recommended to use cables with a section $\geq 4\text{mm}^2$**

16. After connection to the plant, the real time values of parameters are shown by meter:

- Open voltage of the panel installation
- Irradiance value on the panel installation, measured by HT304 sensor
- Value of module temperature

15/06/09 15:34:26	
Vdc	= 367 V
Irr	= 1045 W/m²
Tc	= 45 °C
Module: SUNPOWER 210	
Select	I - V



CAUTION

After pressing the **GO/STOP** key, some different messages can be shown by the meter (§ 6.4) and, in this case, the meter does not perform the test. Check and, if possible, solve this situation before carrying on with the test.

17. Press **GO/STOP** key to start the test. If none of the previous error messages are detected, the message “**Measuring...**” is shown on the display for some seconds, depending on the level of power during test.

15/06/09 15:34:26	
Vdc	= 367 V
Irr	= 1045 W/m²
Tc	= 45 °C
Module: SUNPOWER 210	
Measuring...	
Select	I - V

18. At the end of test, the values of typical parameters (all referred to a single module in standard conditions STC) are shown by the meter together with the final response (§ 6.2.1) based on the automatic calculation performed and relevant to:

- Translation of I-V curve to STC condition
- Verification of tolerance % of the maximum power declared by the manufacturer.

15/06/09 15:34:26	
Voc	= 15.2 V
Vmpp	= 14.7 V
Impp	= 4.7 A
Isc	= 5.2 A
Pmax	= 200 W
FF	= 77.1 %
DPmax	= 2.1 %
Results @ STC – Response: OK	
Select	I - V

19. Press **ENTER** for the visualization of measurement results both in numeric and graphical mode (§ 6.2.1).

20. Use the arrow key ► for the selection of table or graph visualization.

21. Press **SAVE** key to store the result of test or **ESC/MENU** key to exit without saving and to go back to the main menu.

15/06/09 15:34:26	
Voc	= 15.2 V
Vmpp	= 14.7 V
Impp	= 4.7 A
Isc	= 5.2 A
Pmax	= 200 W
FF	= 77.1 %
DPmax	= 2.1 %
Table ►	
Graph ► – Response: OK	
Select	I - V

6.2.1. Meaning of measurement results

The parameter measured and calculated by meter have the following meaning:

Parameter	Description
Pmax	Maximum power of panel measured by the meter
DPmax	Difference % of maximum measured power from nominal power (@ STC)
FF	Fill Factor %
Voc	Open voltage
Vmpp	Voltage on point of maximum power
Isc	Short circuit current
Impp	Current on point of maximum power

Table 2: List of parameter measured by the meter

Where:

DPmax = 100 ABS [(Pmax – Pnom) / Pnom] → check parameter which defines the final response of test

Pnom = nominal power of panel

FF = 100 x [(Vmpv x Impp) / (Voc x Isc)] = Fill Factor → represents a kind of “efficiency” of panel/string as it is a ratio between the maximum power measured and the open power

The meter gives the following final response:

Response	Condition	Note
OK	$- Tol^{(-)} + \varepsilon^{Meter} \leq \varepsilon^{Meas} \leq Tol^{(+)} - \varepsilon^{Meter}$	(1)
OK*	The previous relation (1) is not verified but the following is valid: $- Tol^{(-)} \leq \varepsilon^{Meas} \leq Tol^{(+)}$	(2)
NO OK*	The relations (1) and (2) are not verified but the following is valid: $- Tol^{(-)} - \varepsilon^{Meter} \leq \varepsilon^{Meas} \leq Tol^{(+)} + \varepsilon^{Meter}$	(3)
NO OK	None of the relations (1), (2) and (3) are verified	(4)

where:

$Tol^{(-)} = Tol^{(-)} (\%) * Pnom$ → Negative tolerance in absolute value, declared by manufacturer

$Tol^{(+)} = Tol^{(+)} (\%) * Pnom$ → Positive tolerance in absolute value, declared by manufacturer

$\varepsilon^{Meas} = Pmax - Pnom$ → DPmax which defines the difference between measured values and declared values

ε^{Meter} → Absolute error of the measurement chain (meter + transducers in the point of measure) considering the error % and the declared dgt

(1) OK → Positive response of test also considering the error of measurement chain

(2) OK* → Response of test positive less than the error of measurement chain

(3) NO OK* → Response of test negative less than the error of measurement chain

(4) NO OK → Negative response of test also considering the error of measurement chain

6.3. SERIAL RESISTANCE RS

The serial resistance R_s is one of the typical elements of PV panels which can affect the I-V curve measurement of the panels themselves. The I-V 400 meter performs the R_s calculation, during the measurement of I-V curve (§ 6.2), in the following modes:

- AUTOMATIC mode → the R_s calculation is automatically performed by meter using an approximative evaluation based on the measurement of I-V curve.
- MANUAL mode → the R_s value is given by the internal database where it can be manually input by the operator (§ 5.2.1) or measured (§ 6.3.1).

6.3.1. Serial resistance R_s measurement

The reference standard IEC/EN60891 defines the R_s value with 2 different consecutive measurements at the following conditions:

- Measurement #1: irradiance > 500 W/m²
- Measurement #2: irradiance less respect to the previous measurement #1



CAUTION

The maximum voltage among P1, P2, C1, and C2 inputs is 1000V DC. Do not measure voltages exceeding the limits prescribed by this manual. Should you exceed the voltage limits you could damage the instrument and/or its components or endanger your safety.

1. Turn on the meter by pressing **ON/OFF** key.
2. Check the specifications of the reference cell HT304 (parameters Alpha and Sens.) on meter depending on the type of module **MONOCrystal** or **MULTIcrystal** under test (§ 5.1.4)
3. Check the minimum irradiance threshold set on meter (§ 5.1.5). It is recommended to perform measurements with threshold $\geq 700 \text{ W/m}^2$ in compliance with IEC/EN60891 standard
4. Press **ESC/MENU** key to enter to the herewith main menu
5. Select the “**I-V**” item and press **ENTER** to access the I-V curve measurement section
6. Press the **ENTER** key, select the “**Settings**” item and confirm again with **ENTER**. Select the type of PV module under test among the available models as described in paragraph 5.2.1.
7. Note the name of selected module (ex: SUNPOWER 210) in the screen

15/06/09 15:34:26	
Vdc =	0.0 V
Irr =	- - - W/m2
Tc =	- - - °C
Module: PANEL01	
Settings	
Meas. Type ▶	
Select	I-V

8. Press **ENTER** key and by means of arrow keys (▲, ▼) select the item “**Meas. Type ▶**”
9. By means of arrow key ▶ access the internal submenu, select the item “**RS Test**” and confirm with **ENTER** to open the main screen of R_s measurement.

15/06/09 15:34:26	
Vdc =	0.0 V
Irr =	0 W/m2
Tc =	- - - °C
Module: SUNPOWER 210	
Set	RS Test
Mea	I-V Test
Select	I-V

10. The herewith screen is shown on the display, where:

- R_s = serial resistance
- V_{dc} = DC output voltage from panel measured between C1 and C2 inputs of meter
- I_{rr} = irradiance measured by supplied reference cell
- Module = active module

15/06/09 15:34:26		
R_s	= - - -	Ω
V_{dc}	=	0.0 V
I_{rr}	=	0 W/m²
Module: SUNPOWER 210		
Select		RS Mode

11. Mount the M304 (inclinometer) supplied accessory, position and hold it on the plane of module. **Verify that the sun shadow falls on the disc within the “limit internal circle” on the disc itself (Fig. 8). If this is not the case the incidence angle between sun rays and the module surface is too high and not complying with the test conditions declared by the module manufacturer. As a consequence the measurements performed by the meter are not ok and all measurements steps shall be repeated at another daytime.**
12. Connect the MONO or MULTI output (depending on the type of module under test) of reference cell at the **IRR.** input of meter by using the cable supplied with the cell.
13. Fix the support of the cell to the module by using the supplied set of screws and mount the HT304 reference cell on it possibly with **output terminals downwards with respect to the module**. Rotate the cell upwards to lean it on the small wing of the support to have it perfectly parallel to the module plane, then fix it with the relevant screws supplied.
14. Connect the meter to the module/string under test as shown in Fig. 7. In particular, connect the negative output pole to P1, C1 input terminals and the positive output pole to P2, C2 input terminals

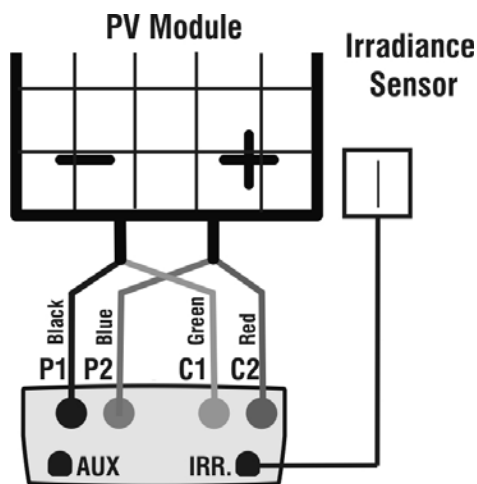

Fig. 7: Connection of meter to a PV module

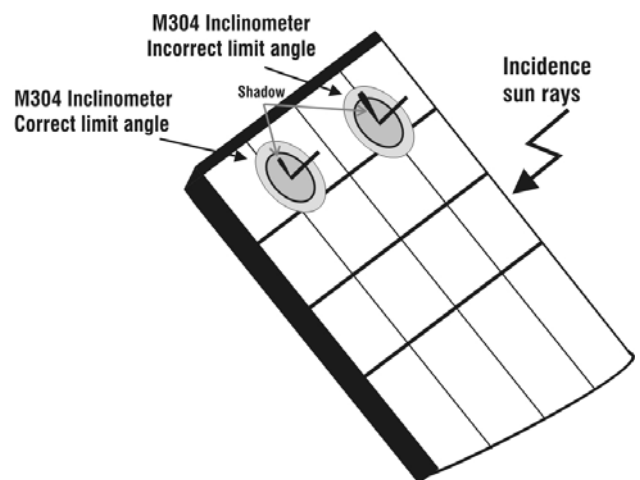

Fig. 8: Positioning of M304 inclinometer

15. After connection to the panel, the real time values are shown by meter:

- Open voltage of the panel installation
- Irradiance value on the panel installation, measured by HT304 reference cell

15/06/09 15:34:26	
Rs	= - - - Ω
Vdc	= 367 V
Irr	= 1045 W/m ²
Module: SUNPOWER 210	
Select	RS Mode



CAUTION

After pressing the **GO/STOP** key, some different messages can be shown by the meter (§ 6.4) and, in this case, the meter does not perform the test. Check and, if possible, solve this situation before carrying on with the test.

16. Press **GO/STOP** key to start the test. If none of the previous error messages are detected, the message "**Measuring 1 running...**" is displayed for about 5 s and the meter performs the first measurement of R_s with the standard conditions of irradiance (§ 5.1.5).

15/06/09 15:34:26	
Rs	= - - - Ω
Vdc	= 367 V
Irr	= 1045 W/m ²
Module: SUNPOWER 210	
Measure 1 running...	
Select	RS Mode

17. After performing the first measurement, the meter enters a waiting mode before starting the second measurement, which should be performed with the panel partially obscured and the message "**Wait for modifying Irrad.**"

18. Cover the module under test and the reference cell (e.g. by using a white plexiglass sheet) in order to reduce the irradiance value measured by a percentage ranging from 40% up to 70% with respect to the previous test.

15/06/09 15:34:26	
Rs	= - - - Ω
Vdc	= 367 V
Irr	= 1045 W/m ²
Module: SUNPOWER 210	
Wait for modify Irrad.	
Select	RS Mode



CAUTION

Do not modify the inclination of the module during the obscuring operation to avoid possible errors on measurements



CAUTION

After pressing the **GO/STOP** key, some different messages can be shown by the meter (§ 6.4) and, in this case, the meter does not perform the test. Check and, if possible, solve this situation before carrying on with the test.

19. Press **GO/STOP** key to start the second measurement. If none of the previous error messages are detected, the meter gives the definitive value of Rs parameter for the panel under test as combination of two previous measurements.
20. Press **SAVE** key to save the result and the "Saved data" message is displayed for a while. Press **ESC/MENU** key to exit without saving and to go back to the previous screen.

15/06/09 15:34:26	█
Rs = 1.21 Ω	
Vdc = 367 V	
Irr = 1045 W/m ²	
Module: SUNPOWER 210	
SAVE to store data	
Select	RS Mode

6.4. LIST OF DISPLAY MESSAGES

MESSAGE	DESCRIPTION
Voltage too low	Check the voltage between C1 and C2 input terminals
Vin > 1000	DC output voltage from module/string > 1000V
Irradiance too low	Irradiance value lower than threshold limit
NTC Error	Internal NTC damaged. Contact service dpt
Please wait for cooling...	Instrument overheated. Wait before starting the tests again
Memory full	Internal memory full. Download data to PC
Pulse width too long	Anomalous condition. Repeat test with more modules
Current too low	Measured current lower than the minimum detectable
Vdc wrong connection	Check the voltage between C1 and C2 input terminals
Negative voltage	Check the polarity of input terminals
Data base full	The number of modules defined is > 30
Data @ STC unavailable	The meter does not calculate the date at STC conditions
Irradiance too high	Irradiance value higher than the maximum range
Data unavailable	Generic error. Repeat the test
Isc too high	Output current higher than maximum range
Wrong date	Set a correct date/hour on meter
Error 1/2/3/4: contact Assistance	Contact service dpt
Error EEPROM : contact Assistance	Contact service dpt
Error FLASH : contact Assistance	Contact service dpt
Error RTC : contact Assistance	Contact service dpt
Battery low	Low battery indication. Fit new batteries inside meter
Error: Vmpp >= Voc	Check the settings of module inside DB section
Error: Impp >= Isc	Check the settings of module inside DB section
Error: Vmpp * Impp >= Pmax	Check the settings of module inside DB section
Error: alpha too high	Check the settings of module inside DB section
Error: beta too high	Check the settings of module inside DB section
Error: Toll too high	Check the settings of module inside DB section
Error: gamma too high	Check the settings of module inside DB section
Module already present	Name of module just used inside DB
Delta-Irrad. too high. Retry	Instable condition on irradiance. Repeat the test
Voltage not steady	Anomalous condition. Repeat test with more modules
Unsteady Current	Difference between 2 consec. Instant. values of current is > 0.13A
Firmware mismatch	Problem with internal FW. Contact service dpt
Ref. Cell temp over range	Temperature measured by reference cell is too high
PV module temp over range	Temperature of module over maximum range
Wrong Mod. Num. Continue?	Setting of number of modules not ok with measured Voc
Ref. Cell temp not detected (ENTER/ESC)	Measure on the cell of module not performed
Unable to calculate Rs value	Rs value external to measurement range
Thermal Instability	The instrument detect unsteady conditions (see § 10.1)

Table 3: List of message at display

7. STORING DATA

The meter allows storing over 200 test of I-V curve in its internal memory. The saved data can be recalled at display and deleted in each moment, and can be associated to reference numerical markers relevant to the installation name, the PV string and the PV module (max 255 markers).

7.1. SAVING I-V CURVE TEST RESULTS

1. Press **SAVE** key with a measured result shown at display.

The following screen is displayed where the herewith items are shown:

- The first memory location available (“Measurement”)
- The numerical marker “Installation”
- The numerical marker “String”
- The numerical marker “Module”
- The field “Comment” where the operator can include a short description (max 14 char) by using virtual keyboard

15/06/09 15:34:26	
Measurement:	007
Installation:	◀ 010 ▶
String:	009
Module:	004
Comment:	
KEYBOARD	
ABCDEFGHIJ	
A B C D E F G H I	J K L M N O P
Q R S T U V W X Y Z	- + 0 1 2 3
4 5 6 7 8 9	SPACE DEL
SAVE for store data	
Comment	MEM – IV

2. Use the arrow keys (▲, ▼) to select the items and (◀, ▶) to set the numeric value of the markers and to use the virtual keyboard. “Comments” field modifications are possible only by changing the number of the “Installation” marker inserting one among the available markers
3. Press ENTER to digit any character of the desired name
4. Confirm with SAVE to complete the data saving.

7.2. MANAGING THE RESULTS

7.2.1. Recall data

1. Press **ESC/MENU** to go back to the main menu, select the “MEM” item and confirm with **ENTER** to access the section for the display of stored data. The herewith screen shows a list of saved tests.
2. The “DATA” label shows the date/time of test saving in the memory.

15/10/09 15:34:26	
MEM	DATA
001	08/10/09 10:38
002	13/10/09 12:15
Select	MEM – IV

3. By means of the arrow key ▶, select the COMMENTS label.
4. The comment inserted by the operator during the saving procedure (§ 7.1) is shown on the display relevant to the tested installation.

15/06/09 15:34:26	
MEM	COMMENTS
001	MODULE 1
002	MODULE 2
Select	MEM – IV

5. By means of the arrow key **▶**, select the “parameters” label.
6. The markers relevant to Installation, String and Module selected by the user during the saving procedure (§ 7.1) are shown on the display.
7. Press **ESC/MENU** to exit the screen and to go back to the main menu.

15/06/09 15:34:26			
MEM	IMP	STR	MOD
001	001	001	001
002	001	001	002
Select			MEM – IV

7.2.2. Delete data

1. Press **ENTER** key in the memory section to show the submenu
2. Select the “Delete” item and press the arrow key **▶**. The options below are shown by the meter:
 - **Del. Last** → delete the last measurement saved
 - **Del. All** → delete all data in the memory
3. Select the desired option with arrow keys (**▲,▼**) and confirm with **ENTER**
4. Press **ESC/MENU** to exit the screen and go back to main menu

15/06/09 15:34:26			
MEM	DATA		
001	15/06/09	12:32	
View			Del. Last
Delete			Del. All
Select			MEM – IV

7.2.3. View data – Numerical screens

1. Select a row corresponding to a saved result and press **ENTER** to access the section for the display of stored data. The herewith screen shows a list of saved tests.
2. Select the “View” item and press **ENTER** to open the section of data visualization in the herewith modes:
 - Numeric screens of parameters measured at the STC conditions and at the operative conditions (OPC)
 - Graphic screens relative to the I-V curves saved at STC and OPC conditions
3. The first screen shows the values of measured parameters, referred to 1 panel, translated to the standard conditions (STC) according to paragraph 6.2.1.
4. Press arrow key **▶**, select by means of arrow keys (**▲,▼**) the option “**OPC – Avg**” and press **ENTER**.

15/06/09 15:34:26			
MEM	INS	STR	MOD
001	001	001	001
002	001	001	002
View			
Delete			▶
Select			MEM – IV

15/06/09 15:34:26		
Voc	48.0	V
Vmpp	39.8	V
Imp	5.24	A
Isc	5.60	A
Pmax	208	W
FF	0.78	%
DPmax	STC	
	OPC – Avg	
Data	OPC	
I-V Graph	▶	
PWR Graph	▶	- OK
Select	I – V	

5. The meter shows the values measured on a string at the real operating conditions (OPC). The values are **averaged on a single panel** (corresponding to the total values should the string be made of a single panel).
6. Press arrow key ► in the first screen, select the option **“OPC”** by means of arrow keys (▲, ▼) and press **ENTER**.

15/06/09 15:34:26		
Voc	46.9	V
Vmpp	39.0	V
Impp	4.85	A
Isc	5.22	A
Pmax	189	W
FF	0.77	%
Irr	927	W/m ²
Tc	25.1	°C
Results @ OPC – Avg		
Select		I – V

7. The meter shows the total values measured at the real operating conditions (OPC) relative **to the string under test**.
8. Press **ESC/MENU** key to exit and go back to the previous screen.

15/06/09 15:34:26		
Voc	46.9	V
Vmpp	39.0	V
Impp	4.85	A
Isc	5.22	A
Pmax	189	W
FF	0.77	%
Irr	927	W/m ²
Tc	25.1	°C
Results @ OPC		
Select		I – V

7.2.4. View data – Graphic screens of I-V curve

1. With screen of numerical values relative to standard conditions (STC) select the item “**I-V Graph**” by means of arrow key ▼ and press **ENTER** or the arrow key ►.
2. Select the “**STC**” option and press **ENTER**.
3. The herewith screen is shown by the meter.

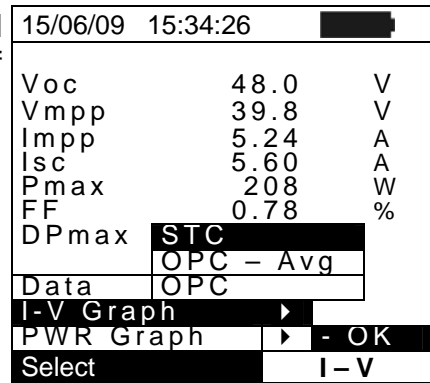

4. The graph is the I-V curve relative to the object under test translated to the standard conditions (STC) and referred to 1 panel.
5. Press **ESC/MENU** key to exit the screen and to go back to the memory section.

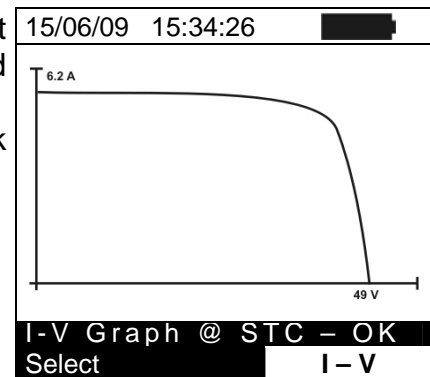

6. With screen of numerical values measured by meter select the item “**I-V Graph**” by means of arrow key ▼ and press **ENTER** or the arrow key ►.
7. Select the option “**OPC - Avg**” and press **ENTER**. The I-V curve graph of a string measured at the real operative conditions (OPC) and displayed by the meter is **averaged on a single panel**.
8. Press **ESC/MENU** key to exit the screen and to go back to the memory section.

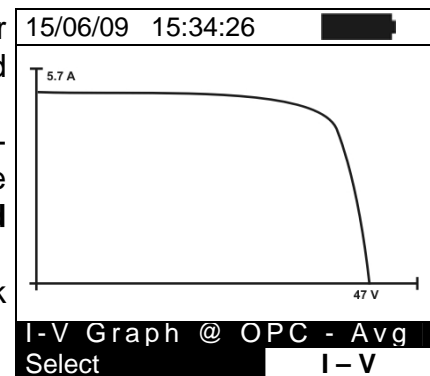

9. With screen of numerical values measured by meter select the item “**I-V Graph**” by means of arrow key ▼ and press **ENTER** or the arrow key ►.
10. Select the option “**OPC**” and press **ENTER**. The I-V curve graph measured at the real operative conditions (OPC) and displayed by the meter corresponds to the **total value relative to the string under test**.
11. Press **ESC/MENU** key to exit from screen and back to the memory section.

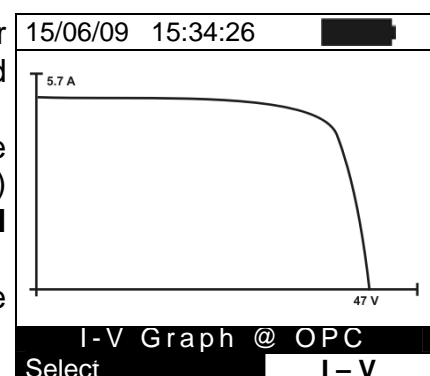

7.2.5. View data – Graphic screens of power

1. With screen of numerical values measured by the meter select the item “**PWR Graph**” by means of arrow key ▼ and press **ENTER** or the arrow key ►.
2. Select the option “**STC**” and press **ENTER**.
3. The herewith screen is shown by the meter.

15/06/09 15:34:26		
Voc	48.0	V
Vmpp	39.8	V
Impp	5.24	A
Isc	5.60	A
Pmax	208	W
FF	0.78	%
DPmax	0.5	%
Data	STC	
I-V G	OPV - Avg	
PWR	OPC	
Select		I - V

4. The graph shows values of output power from panel/string translated to the standard conditions (STC).
5. Press **ESC/MENU** key to exit the screen and to go back to the memory section.

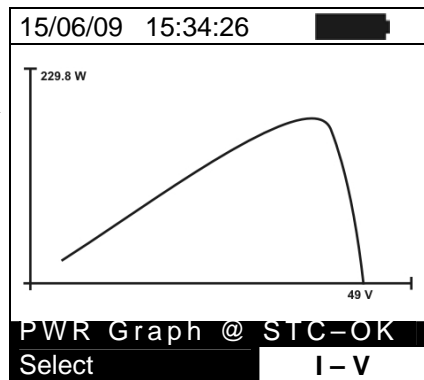

6. With screen of numerical values measured by meter, select the item “**PWR Graph**” by means of arrow key ▼ and press **ENTER** or the arrow key ►.
7. Select the option “**OPC – Avg**” and press **ENTER**. The meter shows the graph of **output power from a single panel of a string** measured at the real operative conditions (OPC).
8. Press **ESC/MENU** key to exit the screen and to go back to the memory section.

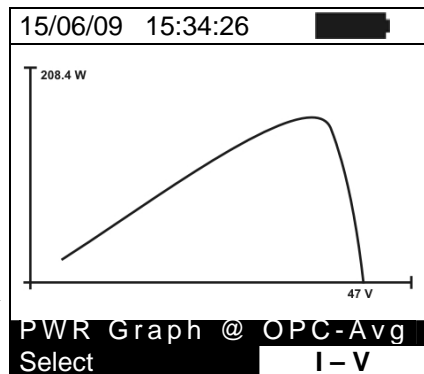

9. With screen of numerical values measured by the meter select the item “**PWR Graph**” by means of arrow key ▼ and press **ENTER** or the arrow key ►.
10. Select the option “**OPC**” and press **ENTER**. The meter shows the graph of **total output power relevant to the string under test** measured at the real operative conditions (OPC).
11. Press **ESC/MENU** key to exit the screen and to go back to the memory section.

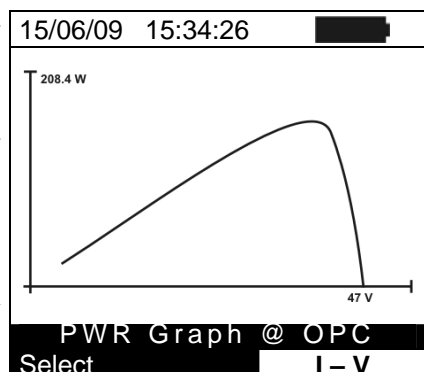

8. CONNECTING THE INSTRUMENT TO A PC

CAUTION



- The instrument can be connected to a PC via a serial port or USB and an optoinsulated cable.
- Before connecting, it is necessary to select the port to be used and the right baud rate (9600 bps) on the PC. To set these parameters, start the **TopView** software and refer to the program's on-line help.
- Check that the release of TopView software is **2.0.0.6-00 or upgraded**. Perform the upgrading, if necessary.
- The selected port must not be engaged by other devices or applications, e.g. a mouse, a modem, etc.
- Optical port emits invisible LED radiations. Do not bring the beam at eye level. Class 1M LED apparatus according to IEC/EN 60825-1

To transfer the saved data to the PC, follow this procedure:

1. Switch on the instrument by pressing the **ON/OFF** key
2. Connect the meter to PC via the optoinsulated cable **C2006** supplied with the software package, after installing this cable's driver.
3. Press **ESC/MENU** key to open the main menu.
4. By means of arrow keys (**▲, ▼**) select the item "**PC**" to access the PC mode section and confirm with **ENTER**.

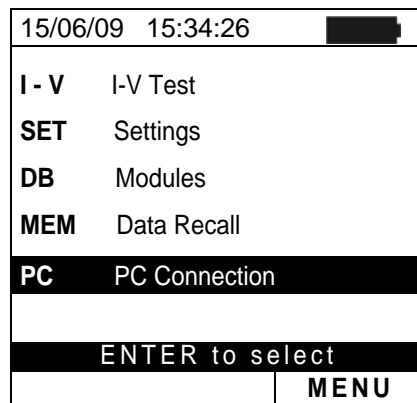

5. The herewith screen is shown by the meter:

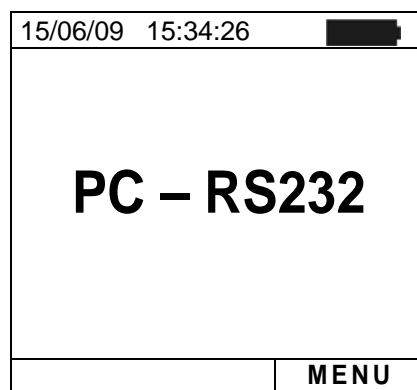

6. Use the data management software TopView for transferring the content of the instrument memory to the PC (see on-line help of this software for all details)

9. MAINTENANCE

9.1. GENERAL

The instrument you purchased is a precision instrument. When using and storing it, please observe the recommendations listed in this manual in order to prevent any possible damage or danger. Do not use the instrument in environments with high humidity levels or high temperatures. Do not directly expose it to sunlight. Always switch off the instrument after using it. Should the instrument remain unused for a long time, remove batteries in order to prevent liquids from leaking out of them, and the instrument internal circuits from being damaged.

9.2. BATTERY REPLACEMENT

When the low battery symbol "" appears on the LCD display, or if during a test the meter gives the message "low battery", it is necessary to replace the batteries.



CAUTION

This operation must be carried out by skilled technicians only. Before carrying out this operation, make sure that all cables have been removed from the input leads.

1. Switch off the instrument by pressing and holding the **ON/OFF** key.
2. Remove the cables from the input leads.
3. Unscrew the cover fastening screw from the battery compartment and remove it.
4. Remove all the batteries from the battery compartment and replace with new batteries of the same type only (§ 10.3) making sure to respect the indicated polarities.
5. Restore the battery compartment cover into place and fasten it by means of the relevant screw.
6. Do not dispose of the used batteries into the environment. Use relevant containers for disposal.

9.3. INSTRUMENT CLEANING

Use a dry and soft cloth to clean the instrument. Never use wet cloths, solvents, water, etc.

9.4. END OF LIFE



CAUTION: this symbol indicates that the equipment, the batteries and its accessories must be collected separately and disposed of in the right way.

10. TECHNICAL SPECIFICATIONS

10.1. TECHNICAL FEATURES

Accuracy is given as [% of reading + number of dgt] at 23°C ± 5°C, <80%HR

VDC Voltage

Range [V]	Resolution [V]	Accuracy (*)
5.0 ÷ 999.9	0.1	±(1.0%rdg + 2dgt)

(*) The I-V curve and Rs measurements start for VDC > 15V and the accuracy is defined for VDC > 20V

IDC Current (by internal sensor) – Detection of I-V curve

Range [A]	Resolution [A]	Accuracy
0.10 ÷ 10.00	0.01	±(1.0%rdg + 2dgt)

MAX measured power (@ Vmpp > 30V, Impp > 2A)

Range [W] (*, **)	Resolution [W]	Accuracy
50 ÷ 9999	1	±(1.0%rdg + 6dgt)

Vmpp = Maximum power voltage, Impp = Maximum Power Current

(*) Max measurable value of Power must include FF value (~ 0.7) → Pmax = 1000V x 10A x 0.7 = 7000W

(**) Test is stopped and the message "Thermal instability" occurs if the instrument detects Voltage > 700V and Current I > 3A, I > 0.038*V + 37.24 - 0.5

MAX Power ref. STC (@ Vmpp > 30V, Impp > 2A)

Range [W]	Resolution [W]	Global Accuracy (*, **)
50 ÷ 9999	1	±(5.0%rdg + 1dgt)

Vmpp = Maximum power voltage, Impp = Maximum Power Current

(*) Test cond.: Steady Irrad. ≥ 700W/m², spectrum AM 1.5, solar incidence vs perpendicular. ≤ ± 25°, Cells Temp. [15..65°C]

(**) Global accuracy include contribute of solar sensor and its measuring circuit

Irradiance (with HT304 reference cell)

Range [mV]	Resolution [mV]	Accuracy
1.0 ÷ 100.0	0.1	±(1.0%rdg + 5dgt)

Temperature (with PT300N probe)

Range [°C]	Resolution [°C]	Accuracy
-20.0 ÷ 100.0	0.1	±(1.0%rdg + 1°C)

10.2. SAFETY SPECIFICATIONS

10.2.1. General

Instrument safety:	IEC/EN61010-1
Technical literature:	IEC/EN61187
Accessory safety:	IEC / EN61010-031
Measurements:	IEC/EN60891
Insulation:	double insulation
Pollution level:	2
Category of measure:	CAT II 1000V DC, CAT III 300V to earth Max 1000V among inputs P1, P2, C1, C2

10.3. GENERAL CHARACTERISTICS

Display and memory

Type of display:	LCD custom, 128x128 pxl, backlighted
Memory capacity:	256kbytes
Number of stored curve:	>200
PC interface:	optical / USB

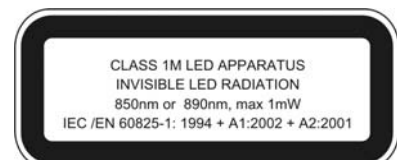

Power supply

Battery type:	6 x1.5 V alkaline type AA L&06
Low battery indication:	symbol "  " is displayed
Battery life:	>200 tests
Auto power off:	after 5 minutes of idleness

Mechanical data

Size:	235(L) x 165(W) x 75(H) mm 9(L) x 6(W) x 3(H) inches
Weight (batteries included):	1.2kg (42 ounces)

10.4. ENVIRONMENT

Reference temperature:	23° ± 5°C (73°F ± 41°F)
Working temperature:	0 ÷ 40°C (32°F ÷ 104°F)
Relative humidity allowed:	<80%RH
Storage temperature:	-10 ÷ 60°C (14°F ÷ 140°F)
Storage humidity:	<80%RH
Max height of use:	2000m (6562 ft) (*)

**CAUTION****(*) Information about the use of meter at altitude from 2000 to 5000m**

As for voltage inputs P1, P2, C1, C2 the instrument is to be considered downgraded to overvoltage category CAT I 1000V DC and CAT II 300V to ground, max 1000V among inputs. Markings and symbols indicated on the instrument are to be considered valid when using it at altitude lower than 2000m

This instrument complies with the prescriptions of the European directive on low voltage 2006/95/CE (LVD) and EMC 2004/108/CE

10.5. ACCESSORIES

See enclosed Packing List.

11. SERVICE

11.1. WARRANTY CONDITIONS

This instrument is guaranteed against any defect in material and manufacturing in compliance with the general sales terms and conditions. Throughout the period of guarantee all defective parts may be replaced and the manufacturer reserves the right to repair or replace the product.

If the instrument is to be returned to the after-sales service or to a dealer transportation costs are on the customer's behalf. Shipment shall be however agreed upon. A report must always be enclosed to a rejected product stating the reasons of its return. To ship the instrument use only the original packaging material; any damage that may be due to non-original packing shall be charged to the customer. The manufacturer declines any responsibility for damages caused to persons and/or objects.

Warranty is not applied in the following cases:

- Repair and/or replacement of accessories and battery (not covered by warranty)
- Any repair that might be necessary as a consequence of a misuse of the instrument or of its use with no compatible devices.
- Any repair that might be necessary as a consequence of improper packaging.
- Any repair that might be necessary as a consequence of service actions carried out by unauthorized personnel.
- Any modification of the instrument carried out without the authorization of the manufacturer.
- Use not provided for in the instrument's specifications or in the instruction manual.

The contents of this manual may not be reproduced in any form whatsoever without the manufacturer's authorization.

All our products are patented and their trade marks registered. The manufacturer reserves the right to modify the product specifications and prices if this is aimed at technological improvements.

11.2. SERVICE

If the instrument does not operate properly, before contacting the after-sales service check cables as well as test leads and replace them if necessary. Should the instrument still operate improperly check that the operation procedure is correct and conforms with the instructions given in this manual.

If the instrument is to be returned to the after-sales service or to a dealer, transportation costs are on the customer's behalf. Shipment shall be however agreed upon. A report must always be enclosed to a rejected product stating the reasons of its return. To ship the instrument use only the original packaging material; any damage that may be due to non-original packing shall be charged to the customer.



Via della Boaria 40
48018 – Faenza (RA) - Italy
Tel: +39-0546-621002 (4 linee r.a.)
Fax: +39-0546-621144
email: ht@htitalia.it
<http://www.htitalia.com>