



Waveguide Horns

50 Years of
Excellence

2.60-40 GHz

Standard Gain Horns

- Primary Standard of Antenna Gain
- 7 Models Cover from 2.60 GHz to 40 GHz

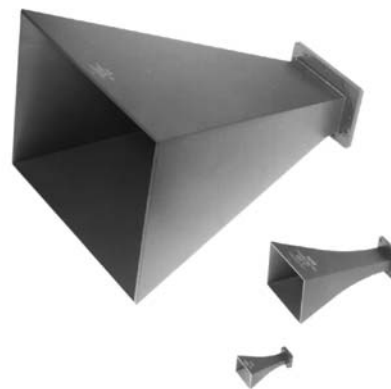

Specifications

FREQUENCY RANGE (GHz)	MODEL	BAND*	WAVEGUIDE SIZE	INPUT COVER FLANGE EQUIVALENT	VSWR (Max)	WEIGHT lbs.	Kg
2.60-3.95	644	S	WR-284	UG-584/U	1.15	6	2.8
3.95-5.85	643	C	WR-187	UG-407/U	1.15	2.3	1.1
5.4-8.20	642	XN	WR-137	UG-441/U	1.15	1.0	0.5
8.20-12.4	640	X	WR-90	UG-135/U	1.15	0.5	0.23
12.4-18	639	KU	WR-62	UG-419/U	1.15	0.2	0.1
18-26.5	638	K	WR-42	UG-595/U	1.15	0.2	0.1
26.5-40	V637	V	WR-28	UG-599/U	1.15	0.1	0.05

*For a complete listing of all band letters and codes in use, refer to Band Designation Table on page 176.

Patterns for all models in this series conform to the following description: Beam width in E and H plane varies from 23° at the highest frequency to 34° at the lowest frequency. Side lobes in the H plane are all more than 20 dB down. First side lobes in the E plane are 13 dB down, second side lobes are 18 dB down and all other E plane lobes are more than 20 dB down.

Gain at Mid Frequency; 16.5 dB (with reference to isotropic radiation) variation is 1.5 dB over total band about the mid band value.

See Waveguide Flange Data on page 188.



Outline Drawing

Standard Gain Horn

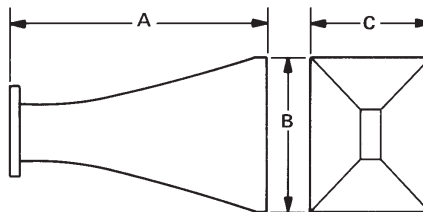

MODEL	A MAX	B MAX	C MAX
V637	1.76 (44.7)	1.06 (26.9)	.82 (20.8)
638	2.57 (65.2)	1.51 (38.3)	1.16 (29.4)
639	3.48 (88.3)	2.20 (55.8)	1.73 (43.9)
640	5.10 (129.5)	3.15 (80.01)	3.40 (60.96)
642	7.76 (197.1)	4.67 (118.6)	3.53 (89.6)
643	10.47 (265.9)	6.34 (161.0)	4.80 (121.9)
644	15.83 (402.1)	9.55 (242.6)	7.25 (184.2)

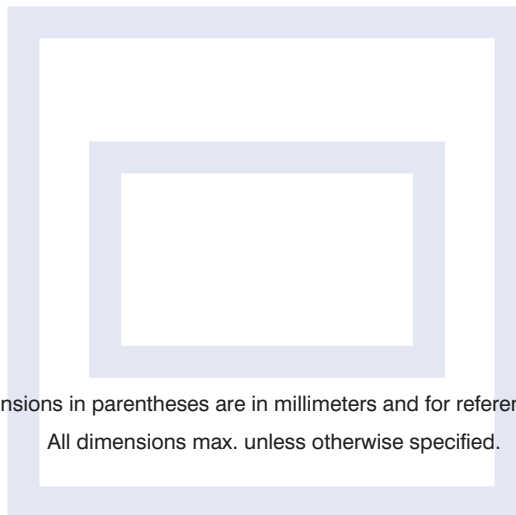

Dimensions in parentheses are in millimeters and for reference only.

All dimensions max. unless otherwise specified.



Waveguide Horns

50 Years of
Excellence**Reference Guide****WAVEGUIDE TO COAXIAL ADAPTERS FOR STANDARD GAIN HORN**

STANDARD GAIN HORN MODEL	WAVEGUIDE TO COAXIAL TYPE N - FEMALE MODEL	ADAPTER SMA/3.5/2.9 FEMALE MODEL
644	614A	—
643	613A	—
642	612A	4602
640	601A	4601
639	609	4609
638	—	4608B
V637	—	V4607

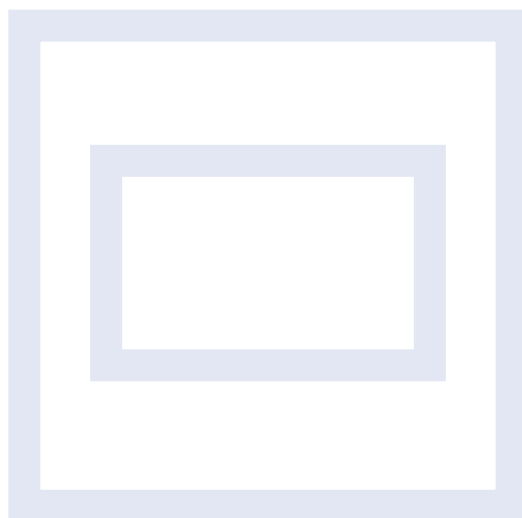

ABSOLUTE GAIN CALIBRATION
NARDA MODEL V637 STANDARD GAIN HORN

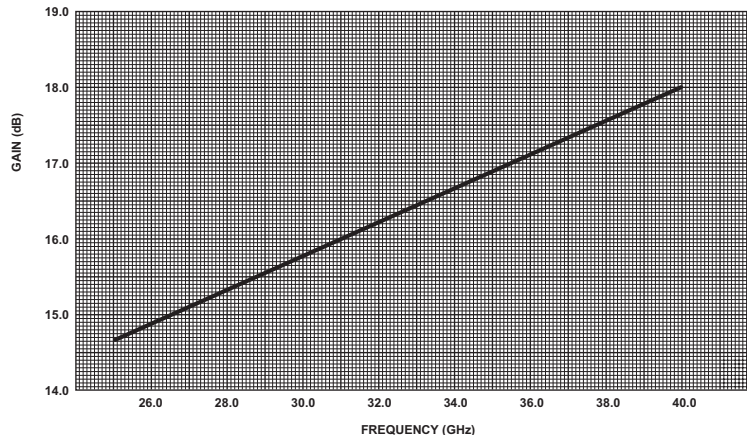

ABSOLUTE GAIN CALIBRATION
NARDA MODEL 638 STANDARD GAIN HORN

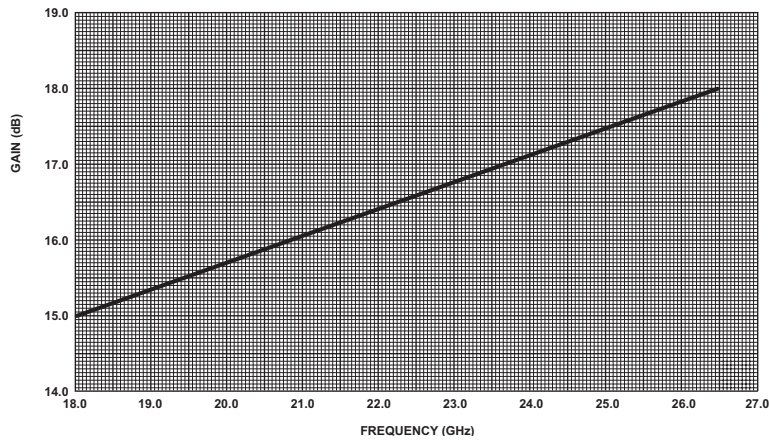

ABSOLUTE GAIN CALIBRATION
NARDA MODEL 639 STANDARD GAIN HORN

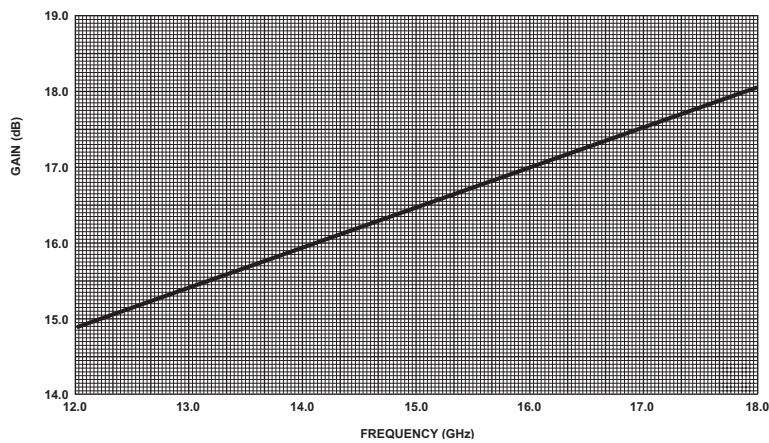

Waveguide Horns

50 Years of
Excellence

ABSOLUTE GAIN CALIBRATION
NARDA MODEL 640 STANDARD GAIN HORN

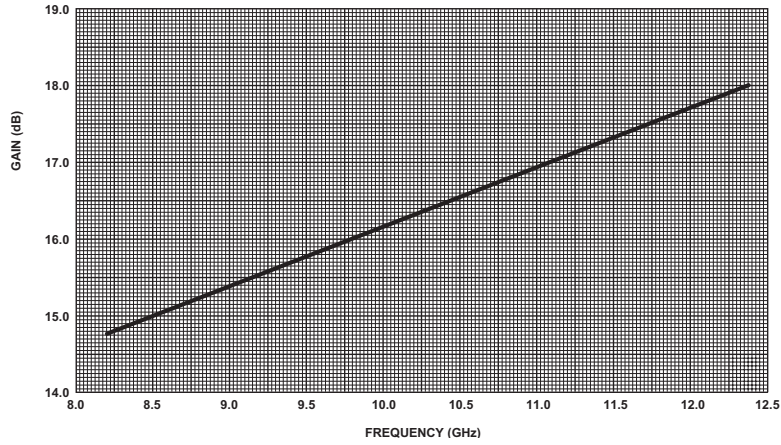

ABSOLUTE GAIN CALIBRATION
NARDA MODEL 642 STANDARD GAIN HORN

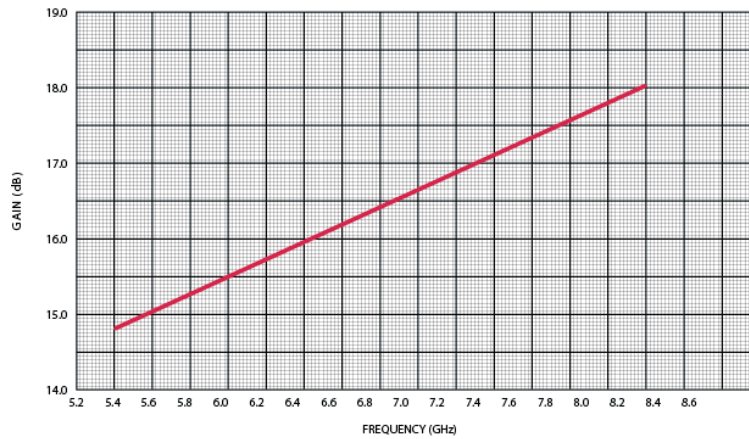

ABSOLUTE GAIN CALIBRATION
NARDA MODEL 643 STANDARD GAIN HORN

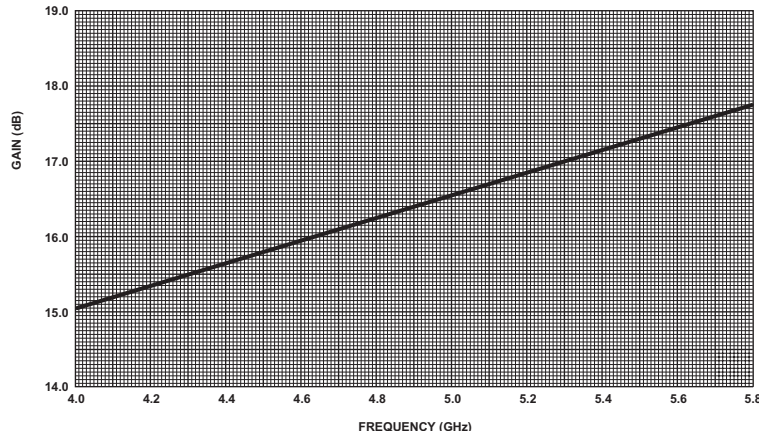

ABSOLUTE GAIN CALIBRATION
NARDA MODEL 644 STANDARD GAIN HORN

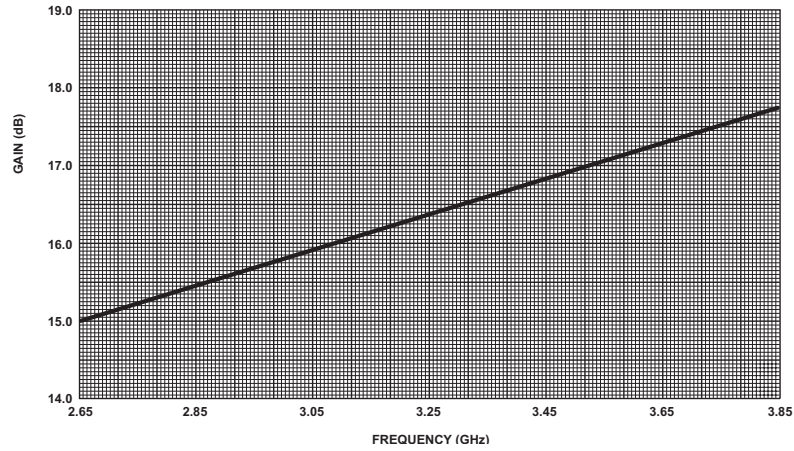

Waveguide Flange Data

50 Years of
Excellence

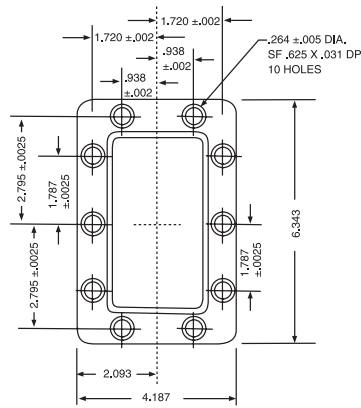

LS BAND

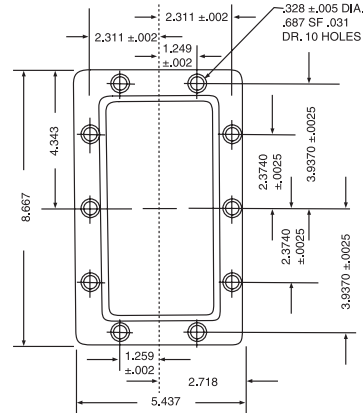

L BAND

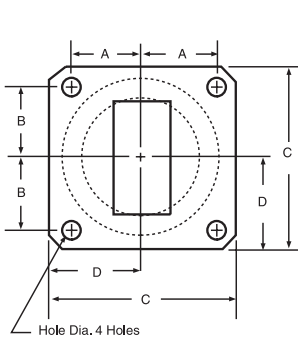

X BAND

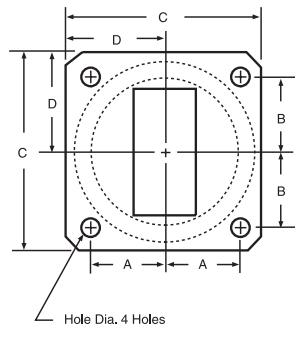

XB BAND

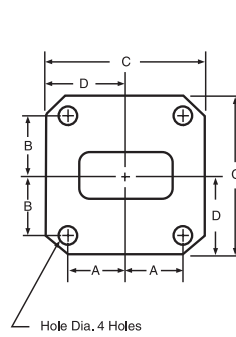

K BAND

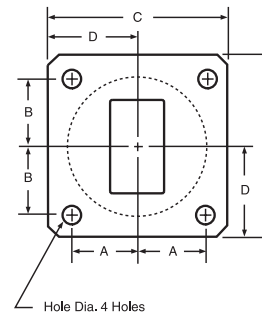

KU BAND

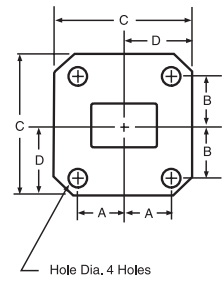

V BAND

BAND*	TYPE	A	B	C	D	HOLE DIA.
X	UG-39/U	.640	.610	1.625	.813	.169
XB	UG-51/U	.737	.676	1.875	.938	.169
K	UG-595/U	.320	.335	.875	.438	.116
KU	UG-419/U	.478	.497	.313	.656	.144
V	UG-599/U	.250	.265	.750	.375	.116

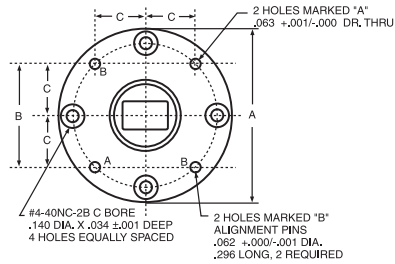

K, V, Q, M, E BAND

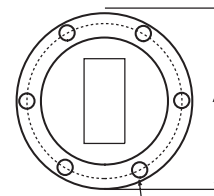

XN, C, S BAND

BAND*	TYPE	A	B	C
K	UG-425/U	1.125	.937	.331
V	UG-381/U	1.125	.937	.331
Q	UF-383/U	1.125	.937	.331
M	UF-385/U	.75	.562	.199
E	UG-387/U	.75	.562	.199

BAND*	TYPE	A	HOLE DIA.
S	UG-53/U	5.313	.257
C	UG-149A/U	3.625	.199

*For a complete listing of all band letters and codes in use, refer to Band Designation Table on page 176.

