

Quick Start Guide

Agilent 4155B Semiconductor Parameter Analyzer
Agilent 4156B Precision Semiconductor Parameter Analyzer



Agilent Technologies

Agilent Part No. 04156-90300
Printed in Japan January 2000
Edition 2

Legal Notice

The information contained in this document is subject to change without notice.

Copyright © 1997, 2000 Agilent Technologies

This document contains information which is protected by copyright. All rights are reserved. Reproduction, adaptation, or translation without prior written permission is prohibited, except as allowed under the copyright laws.

- **Product Warranty**

Agilent Technologies warrant Agilent Technologies hardware, accessories and supplies against defects in materials and workmanship for the period of one year from the warranty start date specified below. If Agilent Technologies receive notice of such defects during the warranty period, Agilent Technologies will, at its option, either repair or replace products which prove to be defective. Replacement products may be either new or like-new.

Warranty service of this product will be performed at Agilent Technologies. Buyer shall prepay shipping charges to Agilent Technologies and Agilent Technologies shall pay shipping charges to return the product to Buyer. However, Buyer shall pay all shipping charges, duties, and taxes for products returned to Agilent Technologies from another country.

Agilent Technologies do not warrant that the operation of Agilent Technologies products will be uninterrupted or error free. If Agilent is unable, within a reasonable time, to repair or replace any product to a condition as warranted, customer will be entitled to a refund of the purchase price upon prompt return of the product.

The Agilent Technologies products may contain remanufactured parts equivalent to new in performance or may have been subject to incidental use.

The warranty period begins on the date of delivery or on the date of installation if installed by Agilent Technologies. If customer schedules or delays Agilent Technologies installation more than 30 days after delivery, warranty begins on the 31st day from delivery.

Warranty does not apply to defects resulting from (a) improper or inadequate maintenance or calibration, (b) software, interfacing, parts or supplies not supplied by Agilent Technologies, (c) unauthorized modification or misuse, (d) operation outside of the published environmental specifications for the product, or (e) improper site preparation or maintenance.

To the extent allowed by local law, the above warranties are exclusive and no other warranty or condition, whether written or oral, is expressed or implied and Agilent Technologies specifically disclaim any implied warranties or conditions of merchantability, satisfactory quality, and fitness for a particular purpose.

Agilent Technologies will be liable for damage to tangible property per incident up to the greater of \$300,000 or the actual amount paid for the product that is the subject of the claim, and for damages for bodily injury or death, to the extent that all such damages are determined by a court of competent jurisdiction to have been directly caused by a defective Agilent Technologies product.

To the extent allowed by local law, the remedies in this warranty statement are customer's sole and exclusive remedies. Except as indicated above, in no event will Agilent Technologies or its suppliers be liable for loss of date or for direct, special, incidental, consequential (including lost profit or date), or other damage, whether based in contract, tort, or otherwise.

For consumer transactions in Australia and New Zealand: the warranty terms contained in this statement, except to the extent lawfully permitted, do not exclude, restrict or modify and are in addition to the mandatory statutory rights applicable to the sale of this product to you.

- **Assistance**

Product maintenance agreements and other customer assistance agreements are available for Agilent Technologies products.

For any assistance, contact your nearest Agilent Technologies Sales Office.

- **Certification**

Agilent Technologies Inc. certifies that this product met its published specifications at the time of shipment from the factory. Agilent further certifies that its calibration measurements are traceable to the National Institute of Standards and Technology (NIST), to the extent allowed by the Institute's calibration facility, and to the calibration facilities of other International Standards Organization members.

Printing History

Edition 1: August 1997

Edition 2: January 2000

In This Guide Book

This guide book is a quick start guide for Agilent 4155B and Agilent 4156B. It introduces basic measurement and analysis without a lot of explanation and details. This guide consists of the following three chapters:

- **Overview:** briefly introduces the 4155B/4156B, also provides solutions to problems you may encounter while using this guide
- **Making a measurement:** preparing for measurements and measuring a sample device (MOS FET).
- **Analyzing a result:** analyzing the results graphically and searching for the threshold voltage (V_{th}) of the MOS FET.

You will find brief instructions for starting measurements with an 4155B/4156B.

Before going to the next page, make sure you have prepared the following:

- Agilent 4155B or Agilent 4156B
- Agilent 16442A test fixture
- Test device (n-channel MOS FET, enhancement type) In this guide, the test device used is a Siliconix SD214DE.

This guide book assumes that you have already installed your 4155B/4156B. If not, refer to "Installation" in *User's Guide General Information*.

Text Conventions

The following text conventions are used in this guide:

Front-panel key	A key that is physically located on the 4155B/4156B.
Screen Text	Text displayed on the 4155B/4156B.
<i>Italic</i>	Refers to a related document, or is used for emphasis.

Finding Further Information

This guide book is written for the 4155B/4156B beginners. See the following books for further information:

- *User's Guide General Information* provides general information of the 4155B/4156B.
- *User's Guide Measurement and Analysis* provides information on how to use the 4155B/4156B for performing measurements and analysis.
- *Programmer's Guide* provides information on how to control the 4155B/4156B with remote commands.
- *GPIB Command Reference* provides reference of GPIB commands.
- *SCPI Command Reference* provides reference of Standard Commands for Programmable Instruments (SCPI) commands.
- *Sample Application Programs' Guide Book* provides description on some sample application programs and setup files.
- *VXIplug&play Driver User's Guide* provides description on the 4155B/4156B VXIplug&play driver and the furnished application program and reference of the 4155B/4156B and Agilent E5250A VXIplug&play driver's functions.

1 **Overview**

Overview

Agilent 4155B Semiconductor Parameter Analyzer and Agilent 4156B Precision Semiconductor Parameter Analyzer are fully, automatic, high performance instruments designed to measure, display graphically, and analyze the dc parameters and characteristics of semiconductor devices such as diodes, transistors, ICs, solar cells, and wafers during the fabrication process. You can evaluate device design, process design, production line, and so on by using the 4155B/4156B.

In semiconductor research and development laboratories, the 4155B/4156B provides precise characteristics evaluation, which is an important step in the development of new high performance devices, and gives design engineers an easy to use method of device parameter acquisition.

On the production line, the 4155B/4156B provides real-time feedback on wafer evaluation to improve the semiconductor process and to increase production yields.

For semiconductor end users, the 4155B/4156B is ideal for circuit design applications and incoming inspection.

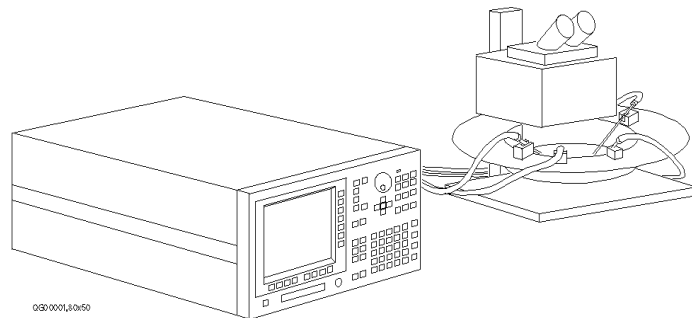

Agilent 4155B/4156B At a Glance

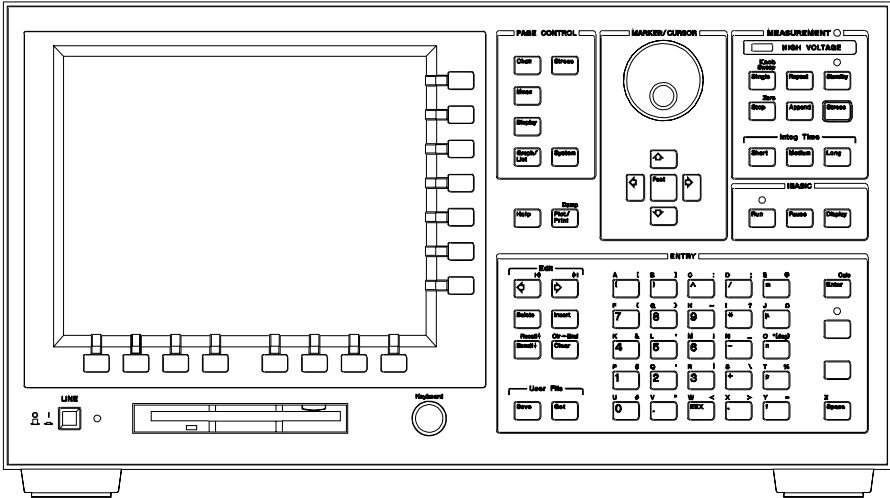

- LINE switch** For applying power.
- Flexible disk drive** For inserting a 3.5-inch diskette, which can be used for mass storage.
- Keyboard interface** For connecting keyboard. So, you can control the 4155B/4156B from keyboard as well as from the front-panel keys.
- Primary softkeys** For changing display screen and secondary softkey menu.
- Secondary softkeys** For selecting variable names and alternatives, and changing items.
- Rotary knob** For changing values, moving a marker, and performing knob sweep.

Overview

Agilent 4155B/4156B At a Glance

Agilent 4155B

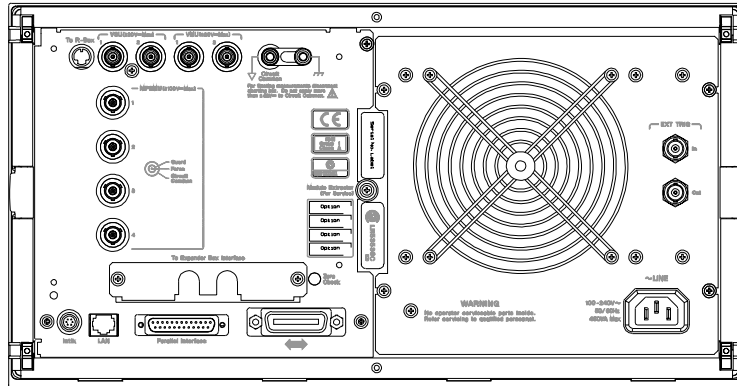

Agilent 4156B

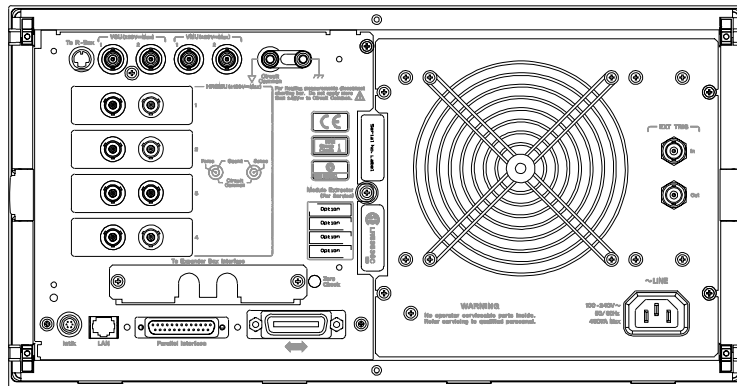

SMU terminals Terminals through which voltage and current are forced and measured by SMUs.

Intlk interface Terminal through which signals for interlock function pass. The interlock function is for preventing electric shock.

If You Have a Problem

This section describes how to solve the following unexpected problems:

- If the 4155B/4156B cannot be powered on
- If display screen does not appear after applying power
- If the 16442A test fixture is not stable

If the 4155B/4156B cannot be powered on

- Check that the power cable is firmly connected to the 4155B/4156B and to power outlet.
- Check that the front-panel LINE switch is on.
- Check that the voltage selector switch is set properly.

The voltage selector switch is located in the lower-right corner of the rear panel. The following table shows the line voltage selector setting.

Line Voltage	Position
84 to 124 Vac	left
200 to 248 Vac	right

- Check that the fuse is good.

The fuse holders located in the lower-right corner of the rear panel.

1. Turn the 4155B/4156B off and disconnect the power cable from the power outlet.
2. Unscrew the fuse holder on the rear panel.
3. Inspect that the correct fuse is installed, and wire inside the fuse is *not* broken by using a restert.

Line	Fuse Type	Agilent Part Number
110/120 Vac	Time-delay type 8A, 250 Vac	2110-0383
220/240 Vac	Time-delay type 4A, 250 Vac	2110-0014

4. Replace the fuse, if necessary. Then, screw in the fuse holder.
5. Turn the 4155B/4156B on.

If display screen does not appear after applying power

- If Agilent 41501 SMU/Pulse Generator Expander is installed, *first* turn on the 41501, *then* turn on the 4155B/4156B.
- If the self-test fails, see "If You Have a Problem" in the *4155B/4156B User's Guide General Information*.

If the 16442A test fixture is not stable

- Install stabilizers on the 16442A.

For this procedure, see "Installation" in the *4155B/4156B User's Guide General Information*.

- If you use the 16442A test fixture with Agilent 16440A selector or Agilent 16441A R-BOX, attach the 16442A to the 16440A or the 16441A by using plates and screws.

For this procedure, see "Installation" in the *4155B/4156B User's Guide General Information*.

2 **Making a Measurement**

Making a Measurement

In this chapter, you learn how to execute the measurements with an 4155B/4156B and to display the measurement results graphically. Id-Vg measurement of a MOS FET is provided as an example. You learn step-by-step how to perform this measurement.

You measure the device under test (DUT) by using the measurement circuit as shown in the following diagram. SMU2 and SMU3 sweep the same voltage to the gate and drain. SMU3 measures the drain current (I_d). The source and substrate are connected to circuit common.

You should get result similar to the following figure. Gate voltage V_g (swept from 0 V to 2 V) is assigned to X axis, $\sqrt{I_d}$ is assigned to Y1 axis, and $\frac{\partial \sqrt{I_d}}{\partial V_g}$ is assigned to Y2 axis.

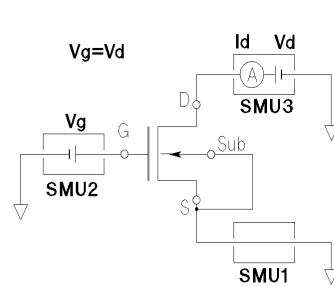

GG01024,145x60

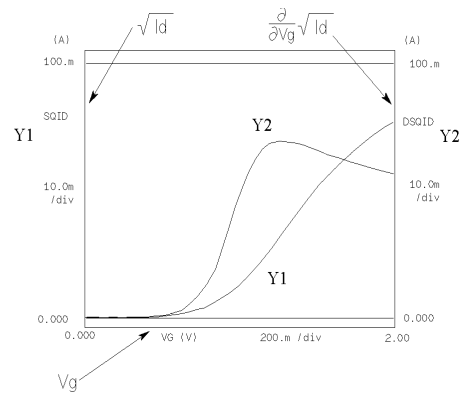

Making a Measurement

Step 1. Prepare for the measurement

Step 1. Prepare for the measurement

Before executing measurement, configure the 4155B/4156B and accessories.

1. Make sure that the 4155B/4156B is off.
2. Connect the 16442A test fixture to the 4155B/4156B. See next figure.
3. If you use the keyboard, connect it to the 4155B/4156B.
4. If you use the 4156B, connect as shown below:

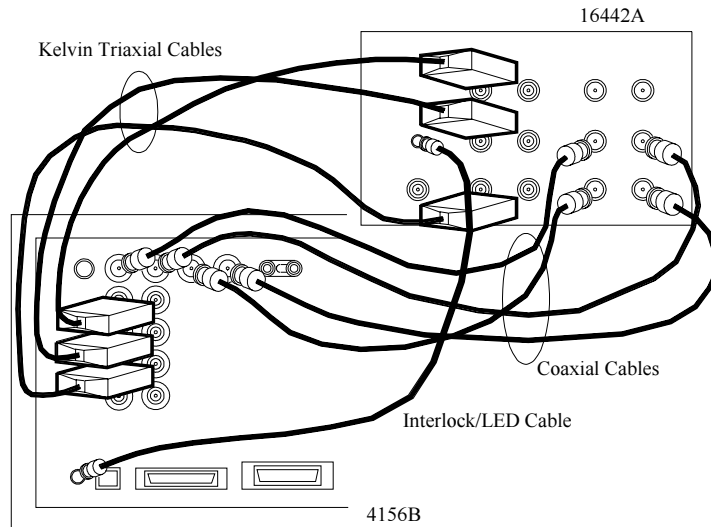

4156B	cable	16442A	4156B	cable	16442A
Intlk	Interlock/LED ^a	Intlk	VSU 1	Coaxial ^b	VSU 1
SMU 1	Kelvin triaxial ^c	SMU 1	VSU 2	Coaxial ^b	VSU 2
SMU 2	Kelvin triaxial ^c	SMU 2	VMU 1	Coaxial ^b	VMU 1
SMU 3	Kelvin triaxial ^c	SMU 3	VMU 2	Coaxial ^b	VMU 2

a. Interlock/LED cable: Agilent 16493J

b. Coaxial cable: Agilent 16493B. You do not need to connect VSUs and VMUs for this measurement.

c. Kelvin triaxial cable: Agilent 16493K

Making a Measurement
Step 1. Prepare for the measurement

If you use the 4155B, connect as shown below:

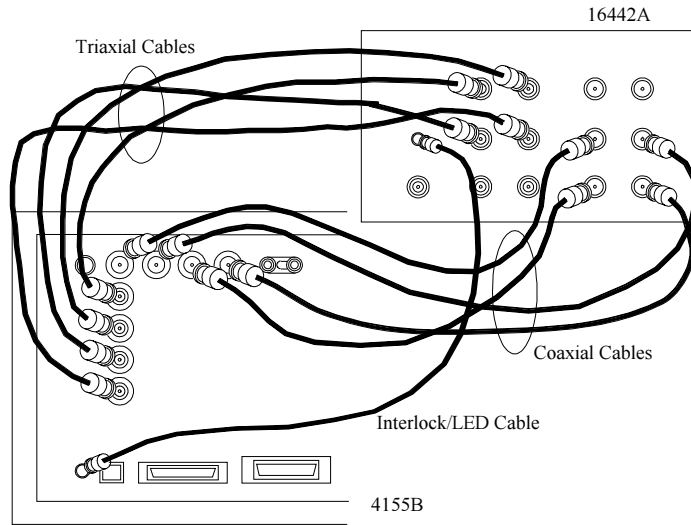

4155B	cable	16442A	4155B	cable	16442A
Intlk	Interlock/LED ^a	Intlk			
SMU 1	Triaxial ^b	SMU 1 (blue label)	VSU 1	Coaxial ^c	VSU 1
SMU 2	Triaxial ^b	SMU 2 (blue label)	VSU 2	Coaxial ^c	VSU 2
SMU 3	Triaxial ^b	SMU 3 (blue label)	VMU 1	Coaxial ^c	VMU 1
SMU 4	Triaxial ^b	SMU 4 (blue label)	VMU 2	Coaxial ^c	VMU 2

- a. Interlock/LED cable: Agilent 16493J
- b. Triaxial cable: Agilent 16493C. You do not need to connect SMU4 for this measurement.
- c. Coaxial cable: Agilent 16493B. You do not need to connect VSUs and VMUs for this measurement.

Making a Measurement

Step 2. Mount your DUT on the test fixture

Step 2. Mount your DUT on the test fixture

1. Select a suitable socket module for your DUT.
2. Mount the socket module on the test fixture.

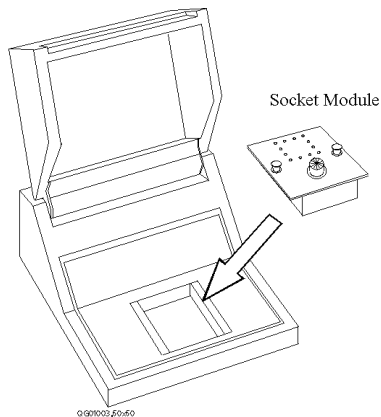

3. Mount your DUT on the socket module.
4. Make connections with four connection cables (miniature banana to pin plug).

You make the following connections:

- Source to SMU1
- Gate to SMU2
- Drain to SMU3
- Substrate to SMU1

Both the source and substrate terminals are connected to SMU1.

5. After finishing connections, shut the lid of the test fixture.

Making a Measurement Step 2. Mount your DUT on the test fixture

Wiring for the 4156B

For this measurement, non-Kelvin connections are used. So, connect only the force terminals as shown in the following figure:

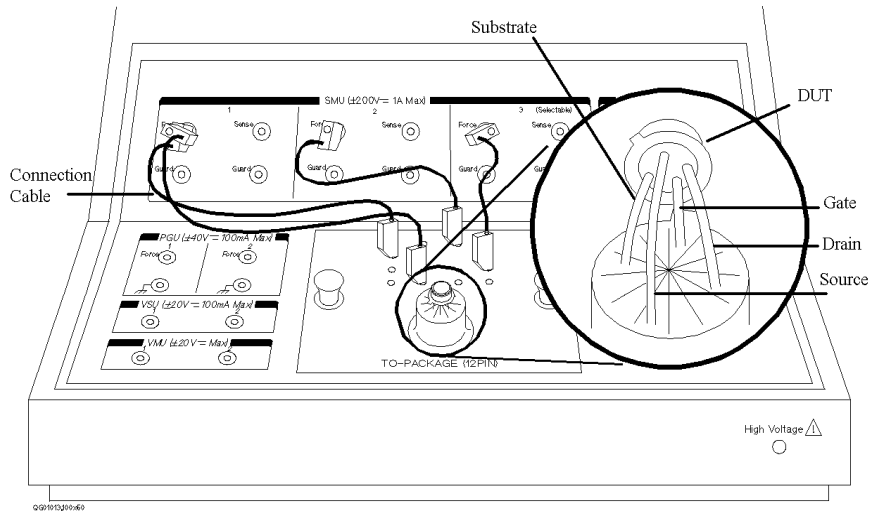

Wiring for the 4155B

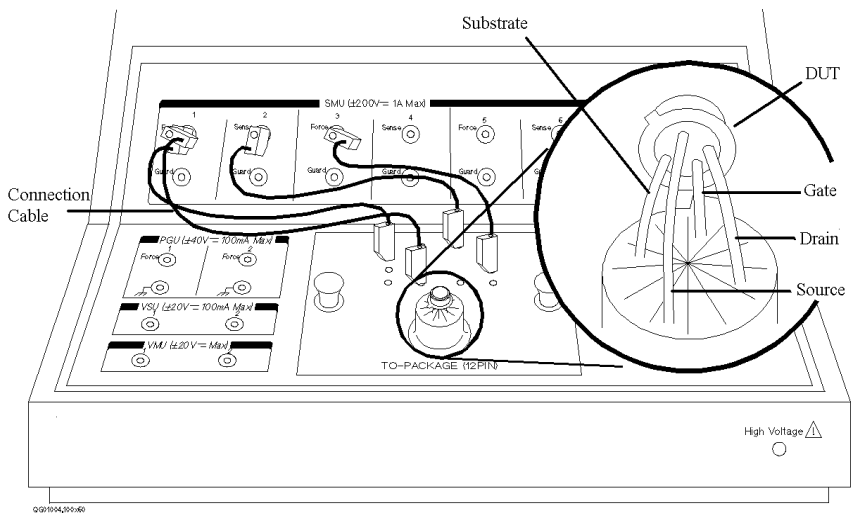

Making a Measurement
 Step 3. Define the channel assignments

Step 3. Define the channel assignments

You set the connection information on the CHANNELS: CHANNEL DEFINITION screen.

1. Turn on the 4155B/4156B. Self-test starts.
2. After self-test is finished, make sure that CHANNELS: CHANNEL DEFINITION screen appears on the screen of the 4155B/4156B. If not, press **Chan** front-panel key.

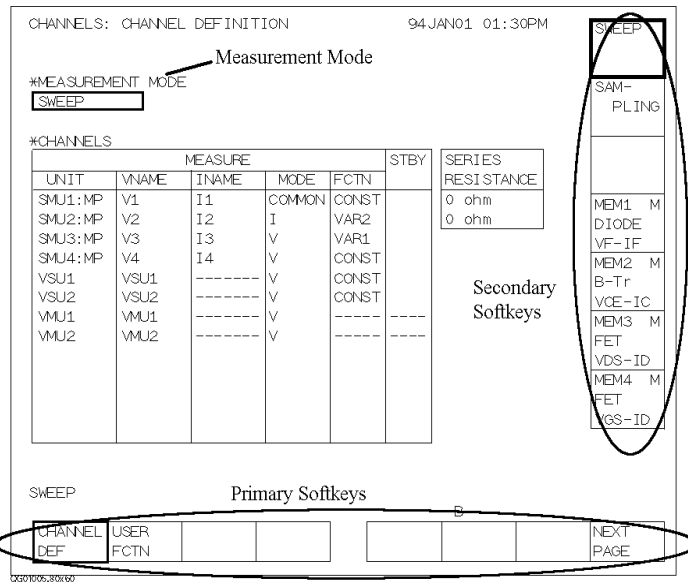

where, softkeys located bottom of screen are the primary softkeys, and softkeys located right side of screen are the secondary softkeys.

3. Make sure that SWEEP is displayed in the MEASUREMENT MODE field. If not, select SWEEP secondary softkey in the MEASUREMENT MODE field.
4. Set the connection information in the CHANNELS area as shown in the following table:

Making a Measurement
Step 3. Define the channel assignments

*CHANNELS

UNIT	MEASURE				STBY	SERIES RESISTANCE
	VNAME	INAME	MODE	FCTN		
SMU1:MP	VS	IS	COMMON	CONST		0 ohm
SMU2:MP	VG	IG	V	VAR1'		0 ohm
SMU3:MP	VD	ID	V	VAR1		
SMU4:MP						
VSU1		-----				
VSU2		-----				
VMU1		-----			----	
VMU2		-----			----	

0621006,70x40

Action	on Front Panel	on Keyboard
To move the pointer,	use arrow keys of MARKER/CURSOR area.	use arrow keys
To move the cursor to edit in display area,	use arrow keys of Edit area.	use Backspace key.
To enter "VS" in VNAME field,	press . (period) and + keys, then Enter .	type VS, then press Enter .
To enter "IS" in INAME field,	press * and + keys, then Enter .	type IS, then press Enter .
To set "V" in MODE field,	select V secondary softkey.	press Shift-F1 keys.
To set "VAR1" in FCTN field,	select VAR1' secondary softkey.	press Shift-F4 keys.
To set "VAR1" in FCTN field,	select VAR1 secondary softkey.	press Shift-F2 keys.
To disable a unit,	select DISABLE UNIT secondary softkey.	press Shift-F7 keys.

Step 4. Define the user functions

You define the user functions on the CHANNELS: USER FUNCTION DEFINITION screen.

1. Select USER FCTN primary softkey. The CHANNELS: USER FUNCTION DEFINITION screen appears.
2. Enter the user function information as shown in the following table:

Action	on Front Panel	on Keyboard
To move the pointer,	use arrow keys of MARKER/CURSOR area.	use arrow keys.
To move the cursor to edit in display area,	use arrow keys of Edit area.	use Backspace key.
To enter "SQID" in NAME field,	press +, 2, *, / keys, then Enter.	type SQID, then press Enter.
To enter "SQRT (ID) " ^a in DEFINITION field,	press +, 2, 3, p, blue key, (keys, and ID secondary softkey, then) and Enter.	type SQRT (ID) , then press Enter.
To enter "DSQID" in NAME field,	press /, +, 2, *, / keys, then Enter.	type DSQID, then press Enter.
To enter "DIFF (SQID , VG) " ^b in DEFINITION field,	press /, *, 7, 7, blue key, (, blue key, +, 2, *, /, blue key, , (comma) keys, and VG secondary softkey, then) and Enter.	type DIFF (SQID , VG) , then press Enter.
To disable a user function,	select DISABLE FUNCTION secondary softkey.	press Shift-F7 key.

- a. Square root operator ($\sqrt{\quad}$) is defined by "SQRT" built-in function.
- b. Partial difference (∂/∂) is defined by "DIFF" built-in function.

After you complete the above instruction, the CHANNELS: USER FUNCTION DEFINITION screen shows the following setup:

Making a Measurement
Step 4. Define the user functions

CHANNELS: USER FUNCTION DEFINITION 94JAN01 01:30PM

NAME	UNIT	DESCRIPTION
SQID	A	SQRT (ID)
DSQID	A	DIFF (SQID, VG)

DELETE ENTRY

DISABLE FUNCTIO

B

CHANNEL DEF	USER FCTN					PREV PAGE	NEXT PAGE
-------------	-----------	--	--	--	--	-----------	-----------

0600007,800160

The above screen defines the following two user functions:

$$SQID = \sqrt{Id}$$

$$DSQID = \partial SQID / \partial Vg = \partial \sqrt{Id} / \partial Vg$$

Where, Id is drain current and Vg is gate voltage.

Making a Measurement

Step 5. Set up the measurement parameters

Step 5. Set up the measurement parameters

You set the output parameters on the MEASURE: SWEEP SETUP screen.

1. Press **Meas** front-panel key. The MEASURE: SWEEP SETUP screen appears.

The screenshot shows the MEASURE: SWEEP SETUP screen with the following parameters:

*VARIABLE		VAR1	VAR2
UNIT		SMU3:MP	
NAME		VD	
SWEEP MODE		SINGLE	
LIN LOG		LINEAR	
START		0.0000 V	
STOP		1.0000 V	
SETP		10.00 mV	
NO OF STEP		101	
COMPLIANCE		100.00mA	
POWER COMP		OFF	

*TIMING		*SWEEP
HOLD TIME	0.000 s	CONTINUE
DELAY TIME	0.0000 s	at Abnormal Status

*CONSTANT			
UNIT			
NAME			
MODE			
SOURCE	-----	-----	-----
COMPLIANCE	-----	-----	-----

Buttons: **SINGLE**, **DOUBLE**, **MEASURE SETUP**, **OUTPUT SETUP**, **PREV PAGE**, **NEXT PAGE**

In the screen, the upper left area defines the VAR1 information, and the upper right area defines the VAR1' information.

2. Set the VAR1 information as shown below:

*VARIABLE	VAR1	VAR2
UNIT	SMU3:MP	
NAME	VD	
SWEEP MODE	SINGLE	
LIN LOG	LINEAR	
START	0.0000 V	
STOP	2.0000 V	
SETP	10.00 mV	
NO OF STEP	101	
COMPLIANCE	100.00mA	
POWER COMP	OFF	

000100950x38

Step 5. Set up the measurement parameters

Drain voltage sweeps from 0 V to 2 V with 10 mV step. The current compliance is set to 100 mA.

Action	on Front Panel	on Keyboard
To move the pointer,	use arrow keys of MARKER/CURSOR area.	use arrow keys.
To set "SINGLE" in SWEEP MODE field,	select SINGLE secondary softkey.	press Shift-F1 keys.
To set "LINEAR" in LIN/LOG field,	select LINEAR secondary softkey.	press Shift-F1 keys.
To enter "2.000 V" in STOP field,	press 2, then Enter.	type 2, then press Enter.
To enter "10.00 mV" in STEP field,	press 1, 0, m, then Enter.	type 10m, then press Enter.

3. Set the VAR1' information as shown below:

	VAR1'
UNIT	SMU2:MP
NAME	VG
OFFSET	0.0000 V
RATIO	1.000
COMPLIANCE	100.00mA
POWER COMP	OFF

To force the same voltage to the drain and gate, set *RATIO* = 1 and *OFFSET* = 0. Because VAR1' is defined as follows:

$$(\text{VAR1}' \text{ output}) = \text{RATIO} \times (\text{VAR1 output}) + \text{OFFSET}$$

Action	on Front Panel	on Keyboard
To enter "0.000 V" in OFFSET field,	press 0, then Enter.	type 0, then press Enter.
To enter "1.000" in RATIO field,	press 1, then Enter.	type 1, then press Enter.

Making a Measurement
Step 6. Set up the results display

Step 6. Set up the results display

You set the results display information on the DISPLAY: DISPLAY SETUP screen.

1. Press **Display** front-panel key. The DISPLAY: DISPLAY SETUP screen appears.

DISPLAY: DISPLAY SETUP 94 JAN01 01:30PM

*DISPLAY MODE
GRAPHICS

*GRAPHICS

	Xaxis	Y1axis	Y2axis
NAME	VD	ID	
SCALE	LINEAR	LINEAR	
MIN	0.00000 V	0.00000 A	
MAX	2.00000 V	100.000mA	

*GRID
ON

*DATA VARIABLE

GRAPHICS

DISPLAY SETUP AUTO ANALYSIS

B

PREV PAGE NEXT PAGE

GRAPHIC LIST

2. Make sure **GRAPHICS** is displayed in the DISPLAY MODE field. If not, select **GRAPHIC** secondary softkey in the DISPLAY MODE field.

Making a Measurement
Step 6. Set up the results display

3. Set the X-, Y1-, and Y2-axes information as shown below:

*GRAPHICS

	Xaxis	Y1axis	Y2axis
NAME	VG	SQID	DSQID
SCALE	LINEAR	LINEAR	LINEAR
MIN	0.00000 V	0.00000 A	0.00000 A
MAX	2.00000 V	100.000mA	100.000mA

030002,80x26

Action	on Front Panel	on Keyboard
To enter "VG" in NAME field,	select VG secondary softkey.	press Shift-F3 keys.
To set "LINEAR" in SCALE field,	select LINEAR secondary softkey.	press Shift-F1 keys.
To enter "0.00000 V" in MIN field,	press 0, then Enter.	type 0, then press Enter.
To enter "2.00000 V" in MAX field,	press 2, then Enter.	type 2, then press Enter.
To enter "SQID" in NAME field,	select MORE 1/2, then SQID secondary softkeys.	press Shift-F7 keys, then Shift-F3 keys.
To enter "0.00000 A" in MIN field,	press 0, then Enter.	type 0, then press Enter.
To enter "100.000mA" in MAX field,	press 1, 0, 0, m, then Enter.	type 100m, then press Enter.
To enter "DSQID" in NAME field,	select MORE 1/2, then DSQID secondary softkeys.	press Shift-F7 keys, then Shift-F4 keys.

Making a Measurement
Step 7. Execute the measurement

Step 7. Execute the measurement

Press **Single** front-panel key to execute the measurement.

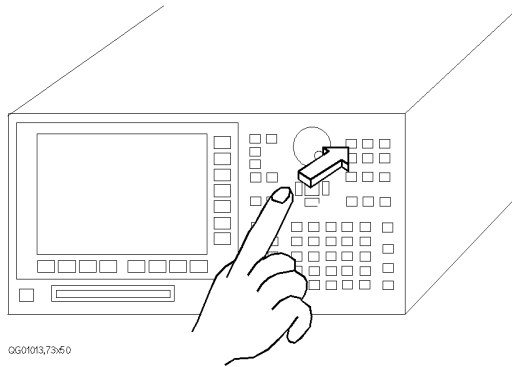

0G0103,73x60

You will get measurement results as shown in the following example:

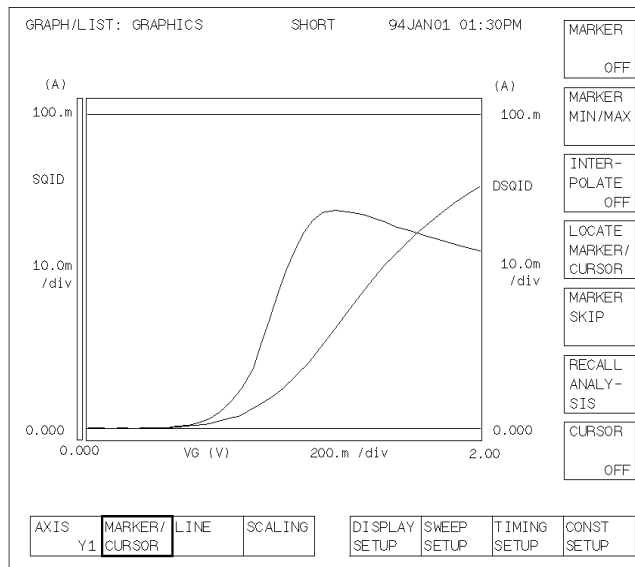

0G0105,80x60

3 Analyzing the Results

Analyzing the Results

In the previous chapter, you measured the drain current (I_d) while performing a synchronous sweep of the gate voltage (V_g) and drain voltage (V_d). And the measurement results were drawn graphically on the screen.

In this chapter, you analyze the measurement results on the graph and search threshold voltage (V_{th}) of the DUT.

The basic algorithm to search for the threshold voltage is:

1. Assign gate voltage (V_g) to X-axis, $\sqrt{I_d}$ to Y1-axis, and $\frac{\partial \sqrt{I_d}}{\partial V_g}$ to Y2-axis.
2. Search for the maximum value of $\frac{\partial \sqrt{I_d}}{\partial V_g}$ curve, which is also the point where the gradient of $\sqrt{I_d}$ curve is maximum.
3. Draw a tangent line to the point where the gradient of $\sqrt{I_d}$ curve is maximum.
4. Read the X-coordinate value where the tangent line crosses the X-axis. This value is threshold value (V_{th}).

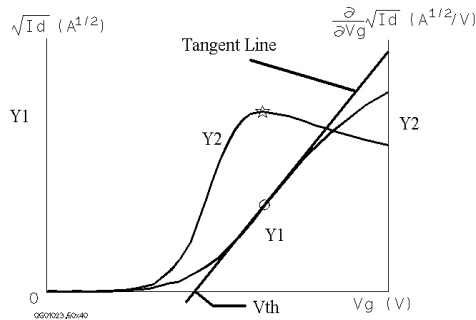

1. Make sure that MARKER/CURSOR primary softkey is highlighted. If not, select the MARKER/CURSOR primary softkey.

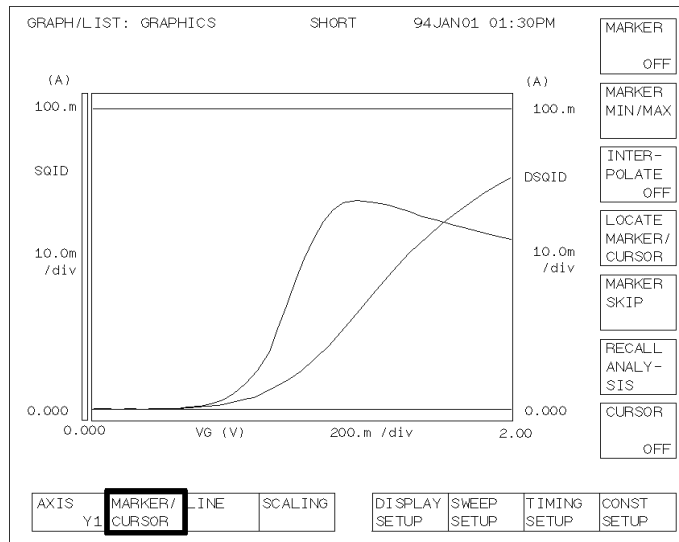

2. Select MARKER secondary softkey so that ON appears on the softkey. The MARKER softkey is highlighted, and the markers appears on the measurement curve.

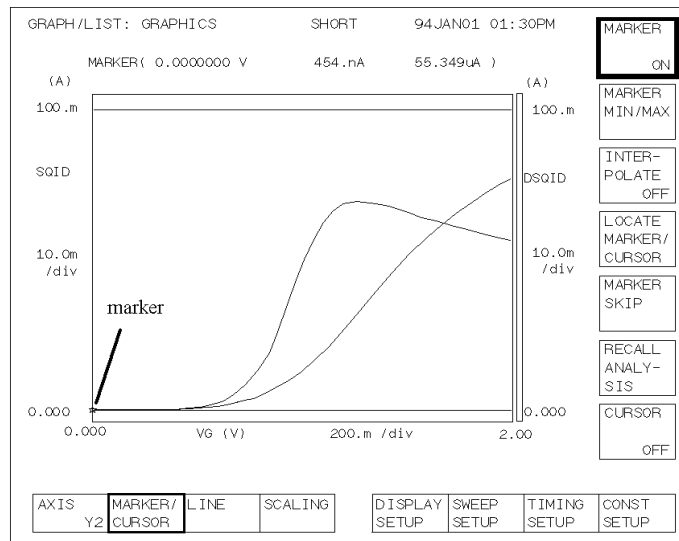

000017,80x60

Analyzing the Results

3. Select **AXIS** primary softkey so that **Y2** appears on the softkey. The **Y2** axis is highlighted.

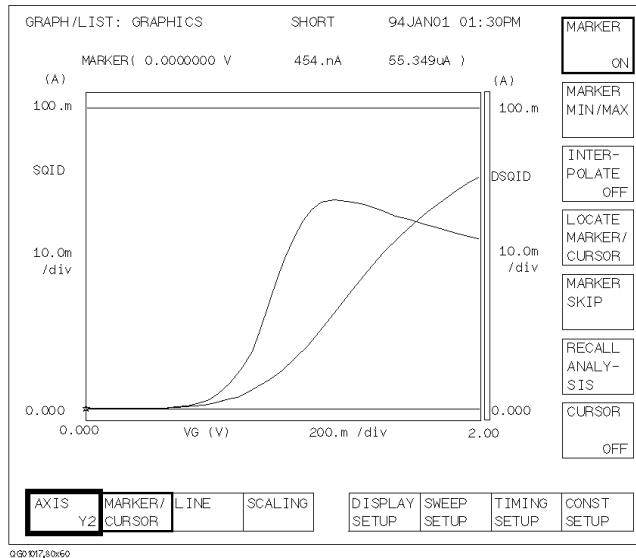

4. Select **MARKER MIN/MAX** secondary softkey until the * marker moves to the maximum point on the **Y2** curve. The **o** marker (on **Y1** curve) also moves to same X-axis point, which is maximum gradient of **Y1** curve.

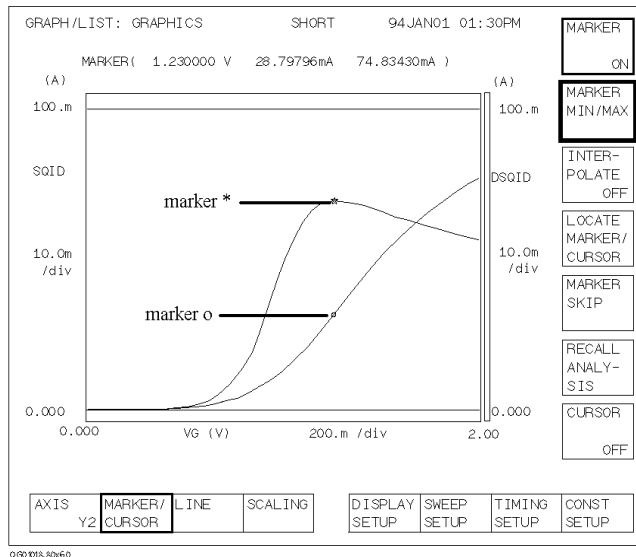

- Select **AXIS** primary softkey so that **Y1** appears on the softkey. The **Y1** axis is highlighted.

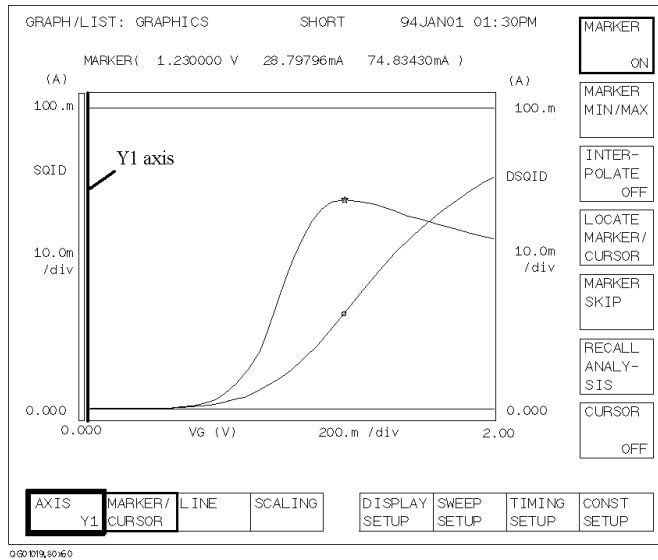

- Select **LINE** primary softkey. The secondary softkey menu changes.

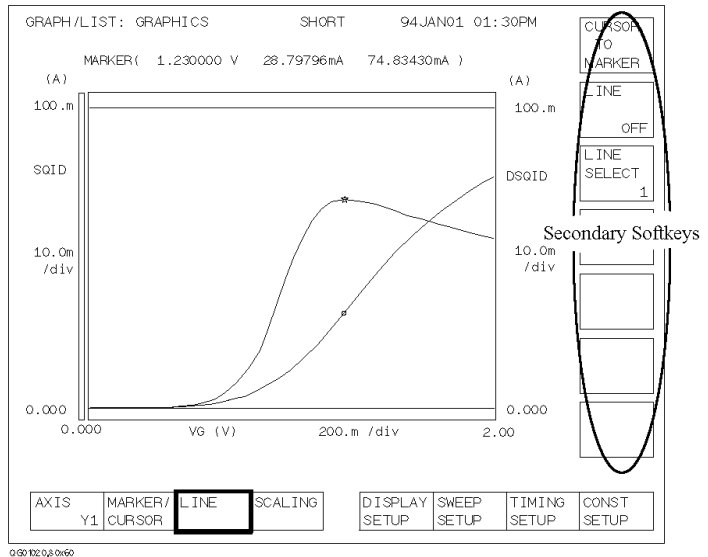

Analyzing the Results

7. Select LINE secondary softkey so that ON appears on the softkey. The LINE softkey is highlighted, and a vertical line appears in the center of the plotting area.

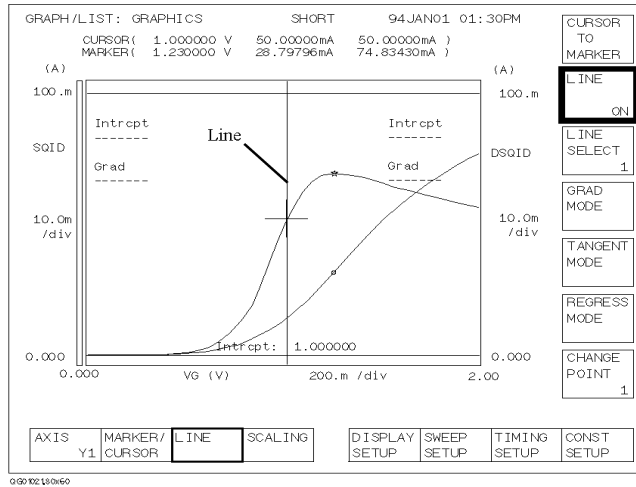

8. Select TANGENT MODE secondary softkey. The line becomes tangent to the \circ marker of the Y1 curve.

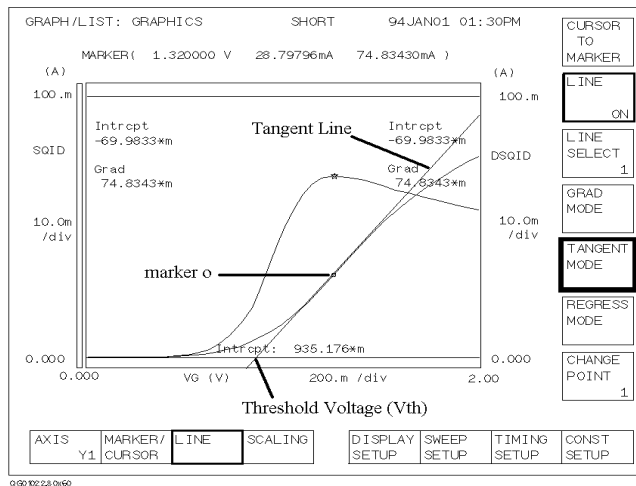

Read the X-axis intercept value of the tangent line. This is the threshold voltage (V_{th}). In the example above, V_{th} is 935 mV.