



Tenney Junior Environmental Test Chamber

OPERATION & MAINTENANCE MANUAL



Model No. TJR, Serial No. 3xxxx

Chamber Type: Temperature

Controller: Watlow 942

CHAMBER OPTIONS

- | | |
|--|---|
| <input type="checkbox"/> TempGard IV - Watlow 93 | <input type="checkbox"/> GN2 Purge |
| <input type="checkbox"/> Boost Heat - Watlow 147 | <input type="checkbox"/> Data Communications |
| <input type="checkbox"/> LN2 Boost Cooling | <input type="checkbox"/> LinkTenn32 Software |
| <input type="checkbox"/> CO2 Boost Cooling | <input type="checkbox"/> Chart Recorder |
| <input type="checkbox"/> Dry Air Purge | <input type="checkbox"/> Alternate Controller - Watlow F4 |

TPS - Thermal Product Solutions
2121 Reach Road
Williamsport, PA 17701
570-326-1770 Fax: 570-326-7304

Rev. 04/30/04

TABLE OF CONTENTS

SECTION	Page
<u>INFORMATION</u>	
1.0 COMPANY INFORMATION & ASSISTANCE _____	4
2.0 SAFETY WARNINGS & SYMBOLS _____	5,6
3.0 PRODUCT SPECIFICATIONS & OVERVIEW _____	7,8
4.0 DRAWINGS, INFORMATION, and VENDOR INSTRUCTION LISTINGS _____	9
5.0 INSTALLATION INSTRUCTIONS	
5.1 Delivery and Uncrating of Unit _____	10
5.2 Location and Installation of Unit _____	10
5.3 Air Supply Connection - - - (for optional equipment) _____	11
5.4 GN2 Connection - - - (for optional equipment) _____	11
5.5 LN2 Connection - - - (for optional equipment) _____	12
5.6 CO2 Connection - - - (for optional equipment) _____	12
5.7 Electrical Specifications _____	13
5.8 Power Connection _____	13,14
5.9 Application of Power _____	14
5.10 Operating With an Active Heat Load _____	14
<u>SYSTEMS and CONTROL</u>	
6.0 AIR CIRCULATION SYSTEM _____	15
7.0 TEMPERATURE CONTROL	
7.1 Controller Features _____	16,17
7.2 Watlow 942 Control Functions _____	18,19
7.3 Watlow F4 Control Functions (Alternate Controller) _____	19
8.0 HEATING DESCRIPTION _____	20
9.0 CHAMBER OVERTEMPERATURE PROTECTION _____	20-22
10.0 CASCADE REFRIGERATION SYSTEM _____	23,24

OPTIONAL EQUIPMENT and FEATURES

11.0	ALARM and SHUTDOWN CIRCUIT - TempGard IV (Optional)	
11.1	System Description _____	25
11.2	Special Hookup of TempGard IV for Model TJR ONLY _____	26
11.3	Circuit Operation _____	27
11.4	TempGard IV Alarm Setpoint Entry _____	28
12.0	BOOST HEAT (Optional) _____	29
13.0	DRY AIR PURGE SYSTEM (Optional) _____	30
14.0	GN2 PURGE AIR SYSTEM (Optional) _____	31
15.0	LN2 BOOST COOLING SYSTEM (Optional) _____	32
16.0	CO2 BOOST COOLING SYSTEM (Optional) _____	33
17.0	LinkTenn32 SOFTWARE (Optional) _____	34
18.0	CHART RECORDER (Optional) _____	35

CHAMBER OPERATION & MAINTENANCE

19.0	SEQUENCE of OPERATION _____	36,37
20.0	PREVENTATIVE MAINTENANCE _____	38,39
21.0	SERVICING CASCADE REFRIGERATION SYSTEMS _____	40-43
22.0	CHAMBER TROUBLESHOOTING GUIDE _____	44,45

SUPPLEMENTAL INSTRUCTIONSRevision History

- ◆ Original Document Dated 04/27/04

1.0 COMPANY INFORMATION & ASSISTANCE

Congratulations on purchasing a chamber from one of the fine divisions of TPS - Thermal Product Solutions. You probably already know us as Lunaire Limited. We've changed our name and expanded our vision with the intent to provide you with more diversified solutions to your thermal product process requirements.

We truly hope that every aspect of chamber design and quality will measure up to your strictest standards. Your chamber has been designed to operate with the reliability you expect for the demands you impose on your product and research testing.

Headquartered in Williamsport, Pennsylvania, which is located in the North-central part of the state, TPS includes the following four divisions that manufacture environmental test chambers and industrial ovens.

Tenney Environmental - - - - - Lunaire Environmental - - - - - Gruenberg Oven - - - - - Blue M

Parts and service inquiries for equipment within each division should be directed to Lunaire Limited by any of the following methods.

Important! Please have the **Model and Serial Numbers** of your unit available when contacting us.



TPS
2121 Reach Road
Williamsport, PA 17701

Phone: 570 - 326 - 1770
Fax - Parts Dept. 570 - 320 - 2160
Fax - Service Dept. 570 - 326 - 3372
Fax - Main: 570 - 326 - 7304
E - Mail Address: service@lunaire.com
Web site: www.thermalproductsolutions.com

Parts Replacement

Your equipment has been designed and manufactured to provide years of reliable service. In the event a component should fail, it is recommended that only OEM approved parts be used as replacements. Please contact the Parts Department for component replacement, or repair.

2.0 SAFETY WARNINGS & SYMBOLS



1. Read this entire Operation Manual, as well as the vendor manuals and cut-sheets provided before operating this equipment! Failure to adhere to any Safety Warning, or failure to follow the proper operating procedures listed throughout any of the information provided, could cause damage to your equipment, personal injury, or death.
2. Do not use this equipment in any manner not specified in this manual. Improper use may impair the safety features employed and will void your warranty.
3. For chambers that are not rated Explosion Resistant: The air conditioning section contains low mass, open wire heating elements. Due to this low mass, the heater elements can readily attain temperatures sufficiently high to ignite gas vapors. Do not install test articles that may release explosive or flammable vapors in the chamber.
4. Only qualified service personnel should ever be permitted to perform any service-related procedure on this equipment!
5. Do not place the unit near combustible materials or hazardous fumes or vapors.
6. Do not install unit in a corrosive environment. A corrosive environment may lead to poor performance and deterioration of unit.
7. Make sure the chamber and any remote equipment provided are leveled when installed.
8. A main power disconnect may not be provided with your unit. If not provided, we recommend that a fused disconnect switch on a separate branch circuit be installed as the power source in accordance with all National and Local Electrical Codes. If your unit is equipped with a power cord and plug, you must utilize a receptacle with the appropriate rating, which is on a branch circuit of its own.
9. Do not position the chamber in a manner that would make it difficult to operate your main power disconnect switch.
10. Your power supply line voltage may be too low or too high to properly and safely operate your equipment. Before making the power supply connection to your equipment, you must follow the specific directions stated under "Power Connection" in the Installation Instructions section. Failing to perform the directions stated may damage your equipment and void your warranty!
11. Control panels, gauge boxes, the conditioning compartment, etc., contain exposed electrical connections. Keep panels in place properly when the unit is in operation. Disconnect and Lock-Out / Tag-Out all electrical power from the unit at its source before servicing or cleaning.
12. Refrigerant under high pressure is used. Only qualified refrigeration mechanic personnel should ever be permitted to perform any service-related procedure on the refrigeration system.
13. Do not adjust any mechanical components such as refrigeration valves or any electrical components except as directed in this manual.
14. Human exposure to temperature extremes can cause injury. Take appropriate precautions before opening chamber doors and upon handling test specimens.
15. Do not modify any component on this unit. Use only original equipment manufactured (OEM) parts as replacement parts. Modifications to any component, or the use of a non-OEM replacement part could cause damage to your equipment, personal injury, or death.

INTERNATIONAL WARNING / SAFETY SYMBOL DEFINITIONS

Obey all “DANGER”, “WARNING”, and “CAUTION” labels shown in the manual and mounted on the equipment. Do not remove any labels mounted on the equipment.

“WARNING OF HAZARDOUS AREA”



“WARNING OF DANGEROUS ELECTRIC VOLTAGE”

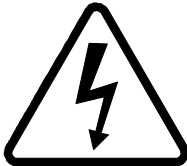

“WARNING OF HOT SURFACE”

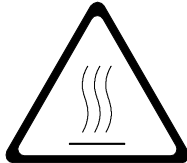

“EARTH (GROUND) PROTECTIVE CONDUCTOR TERMINAL”



3.0 PRODUCT SPECIFICATIONS & OVERVIEW

Application:

This manual applies to the following reach-in temperature test chambers, which employ a capillary tube type refrigeration system.

Model TJR: Tenney Junior - Benchtop Unit

Model TU-JR: Tenney Junior - Upright Unit

Specifications:

- ◆ Temperature Range: -75 to +200 degrees Celsius, ± 0.3 degrees Celsius
- ◆ Workspace: 15-5/8" W x 11" D x 11-3/4" H (40 W x 28 D x 30 H Centimeters)

Note: This manual may also apply to special chambers with alternate model numbers (listed below).

For Model XXXX, S/N xxxxx, the following custom specifications apply:

- ◆ Temperature Range: - xx° to + xxx° C, +/- xx deg. after stabilization

Environmental Conditioning Functions:

- ◆ Heating of the chamber is achieved by recirculating chamber air through open-air nichrome wire heater elements.
- ◆ Cooling of the chamber is achieved by recirculating chamber air through a refrigerated cooling coil in the chamber conditioning section. The chamber is equipped with a cascade refrigeration system. Non-CFC refrigerants are used.
- ◆ Air circulation is generated by a propeller type fan, which is driven by an externally mounted motor.

Temperature Controller:

Either the standard Watlow 942 Controller or the optional Watlow F4 Controller is used for temperature control. The type used is indicated on the manual cover page.

- ◆ **Watlow 942 (Standard):** The Watlow 942 Controller is a ¼ DIN profiling type controller. Profile operations include 24-step program capability, time/temperature profile - rate, or time - based programming, guaranteed soak deviation, and program looping. The W942 can also be used for simple single, or fixed set point operation.

An RTD sensor is used for temperature measurement. Dual outputs are configured in the time proportioned, On/Off, or switched dc modes. Two optional auxiliary outputs can be set up as alarms, or

time-based events. Optional retransmit output allows the retransmit of set point or process variable. Data communications is optional using RS232/RS423, RS422, EIA-485, or IEEE interface.

- ◆ **Watlow F4 (Optional):** The Watlow F4 Controller is a ¼ DIN profiling type controller, which is designed for demanding ramp and soak applications. Up to 256 steps can be programmed into as many as 40 variable-length, nameable profiles. A four line high definition LCD interface display enhances guided software to make profile programming and controller configuration faster and easier. A 16-bit microprocessor provides this operational versatility, along with precise process control. The F4 can also function as a static set point controller. EIA-232 and EIA-485 serial communications with Modbus RTU protocol is standard.

Chamber & Product Over/Under Temperature Protection:

Chamber overtemperature protection is provided with a thermal cutoff device. Product over/under temperature protection may be provided with an optional alarm output from the main controller. The optional TempGard IV feature with the Watlow 93 Controller may be used for redundant product over/under temperature protection. These devices are configured in a comprehensive alarm and shutdown circuit.

Additional Options:

Your Tenney chamber may include many other options such as boost heating, boost cooling using LN2 or CO2, a purge air system using compressed air or GN2, a chart recorder, and LinkTenn32 software. LinkTenn32 is an enhanced software program that provides centralized remote monitoring, and the control of multiple process controllers / chambers simultaneously.

As you can see, Tenney Environmental Test Chambers are diversified tools designed to encompass a wide range of operating conditions and functions. If you come upon any questions as you continue on through the manual, please contact our Service Department.

4.0 DRAWINGS, INFORMATION, and VENDOR INSTRUCTION LISTINGS

The following drawings are provided:

Electrical Schematic - Model TJr. (Std. with Watlow 942 Controller)	E - 2684 - 4
Electrical Schematic - Model T-U Jr. (Std. with Watlow 942 Controller)	E - 2686 - 4
Electrical Schematic (Std. with Watlow F4 Controller)	E - 2515 - 4
Electrical Schematic (Special Chambers with any controller)	E - 2xxx - 4
Power Transformer Options - Electrical Schematic (with option only)	E - 2340 - 3
Boost Heat Option - Electrical Schematic (with option only)	E - 1873 - 3
Refrigeration Schematic	R - 904 - 4

The following vendor manuals and information are provided:

Watlow 942, or F4 Controller Manual
 Test Report

Optional Equipment – Vendor manuals will be supplied when the option is included.

Data Communications Manual (W942 - Data Com. is separate, WF4 - Data Com. is integrated in main mnl.)
 LinkTenn32 Software
 Watlow 93 Controller Manual (TempGard IV Feature)
 Watlow 147 Limit Controller Manual
 Chart Recorder Manual
 Heatless Dryer Manual (with dry air purge option)

5.0 INSTALLATION INSTRUCTIONS

Read this section **completely** before attempting to install, or operate the equipment.

5.1 Delivery and Uncrating of Unit

Inspect equipment and shipping crate immediately upon receipt. If any damage is apparent, you should discuss it with the trucking delivery person and contact the transportation company immediately. Make notes of any damage on the Bill Of Lading. Retain all shipping materials for inspection. Any claims for damage must start at the receiving point. Check packing slip carefully and make sure all materials have been received as indicated on the packing ticket. Unless otherwise noted, YOUR ORDER HAS BEEN SHIPPED COMPLETE.



Chambers and any remote machinery skids or control cabinets should be handled and transported in an upright position. They **must never** be carried on their back, front, or any side.

Important! Inspect the circulation fan inside the chamber. The fan is driven by a motor that is mounted in isolation bushings. Sometimes during shipping, the motor is pushed out of vertical alignment. If this has occurred, the fan blade will strike the casing. Eliminate the interference by pushing the motor back into alignment on its rubber mounts. However, be sure that the shipping abuse was not so great that the extension shaft on the fan has been bent.

Important! Do to the vibration incurred during shipping and handling, it is possible that mechanical connections could become loose. Check all connections to make sure they are secure.

5.2 Location and Installation of Unit

Your equipment has been fully operated, tested, and balanced in our plant prior to shipment, **unless notified otherwise**. Follow the installation requirements below.

- ◆ Chamber Weight: Approximately 260 lbs.
- ◆ Environmental Specifications (For CE European Marked Chambers Only)
Pollution Degree 2, Installation Category III
- ◆ Do not place the unit near combustible materials or hazardous fumes or vapors.
- ◆ Ventilation: The chamber should be installed in an area where there is good air ventilation, especially if an air-cooled condenser is used. Allow a minimum of 18 inches between any wall and chamber side, or to any equipment mounted to the chamber side.
- ◆ Do not install unit in a corrosive environment. A corrosive environment may lead to poor performance and deterioration of unit.
- ◆ **Do not position the chamber in a manner that would make it difficult to operate your main power disconnect switch.** See "Power Connection" below.
- ◆ Make sure the chamber is leveled when set up.

5.3 Air Supply Connection (For Optional Equipment)

Your chamber will require a compressed air supply for the Dry Air Purge System option. The system is mounted on the back side of the chamber. The supply should be clean and dry, and range from 80 PSIG min. to 100 PSIG max. The connection type is 1/4" FPT. Make sure the connection is secure. Reference the corresponding "Option" section in this manual, or your chamber specifications for more details.

Flow Adjustments:

Adjust the **flow adjustment valve** at the supply connection to maintain 100 PSIG max. Adjust the flowmeter **metering valve** to approximately 300 cubic feet per hour.

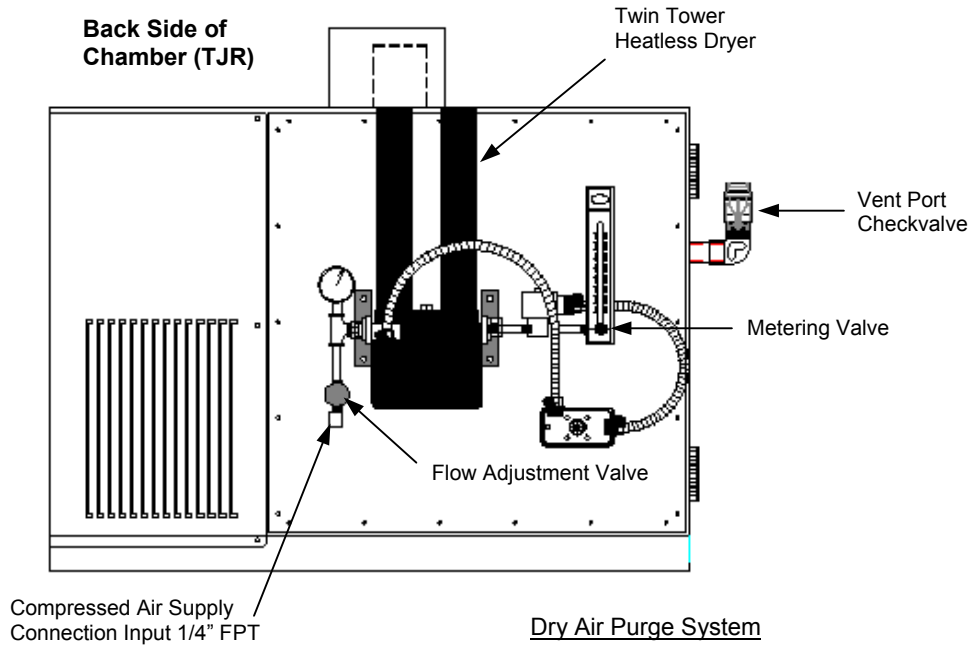

5.4 GN2 Connection (For Optional Equipment)

Your chamber will require a supply of gaseous nitrogen for the GN2 Purge System option. The supply may range up to 100 PSIG maximum. The connection is type 1/8" NPT. Make sure the connection is secure. Reference the corresponding "Option" section in this manual and your chamber specifications for more details.



Warning! Gaseous nitrogen displaces oxygen. Make sure the area surrounding the chamber is well ventilated to dilute the gas vented from the chamber vent port checkvalve.

Flow Adjustment:

Adjust the metering valve to maintain approximately 300 cubic feet per hour.

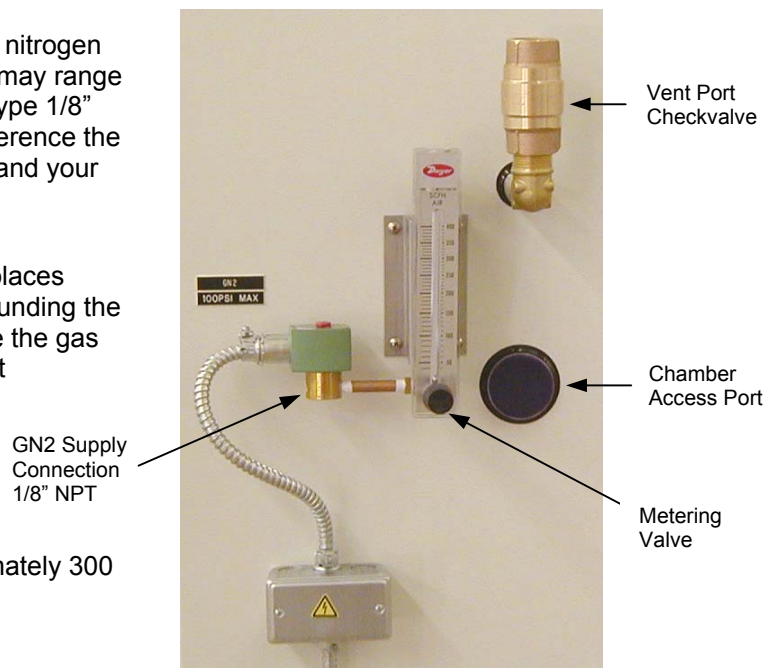

5.5 LN2 Connection (For Optional Equipment)

Your chamber will require a supply of liquid nitrogen for the LN2 Boost Cooling option. The supply may range up to 40 PSIG maximum. The connection is type 1/8" NPT. Make sure the connection is secure. Reference the corresponding "Option" section in this manual and your chamber specifications for more details.



Warning! Gaseous nitrogen resulting from vaporized LN2 displaces oxygen. Make sure the area surrounding the chamber is well ventilated to dilute the gas vented from the chamber vent port checkvalve!

LN2 Flow Adjustment:

LN2 systems are provided with a manually set flow adjusting valve, which permits the adjustment of nitrogen flow to avoid incomplete evaporation at varying LN2 supply pressures. As the chamber cools to the extreme cold temperature limit, complete evaporation of liquid nitrogen may not occur if the supply pressure is allowed to drop. Incomplete evaporation will cause droplets of liquid to fall to the chamber floor and cause puddling.



Do not allow liquid nitrogen to contact the door gasket. Exposure to LN2 will damage the gasket and violate the seal.

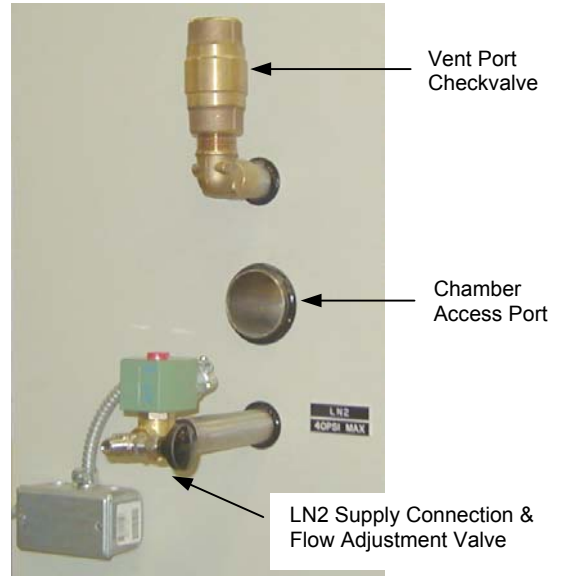

LN2 Boost Cooling

A setting of 4 turns open of the valve generally provides good performance at a supply pressure of 20 to 25 PSIG. This valve may be readjusted as necessary to accommodate the supply pressure at the end use point.

Note: Your equipment configuration may be slightly different from what is shown.

5.6 CO2 Connection (For Optional Equipment)

Your chamber will require a supply of liquid carbon dioxide for the CO2 Boost Cooling option. The supply may range up to 1000 PSIG. The connection is type 1/8" NPT. Make sure the connection is secure. Reference the corresponding "Option" section in this manual and your chamber specifications for more details.



Warning! Carbon Dioxide gas displaces oxygen. Make sure the area surrounding the chamber is well ventilated to dilute the gas vented from the chamber vent port checkvalve!

Note: There is no flow adjustment for the CO2 supply. A fixed orifice on the injection port inside the chamber regulates the supply.

Note: Your equipment configuration may be slightly different from what is shown.

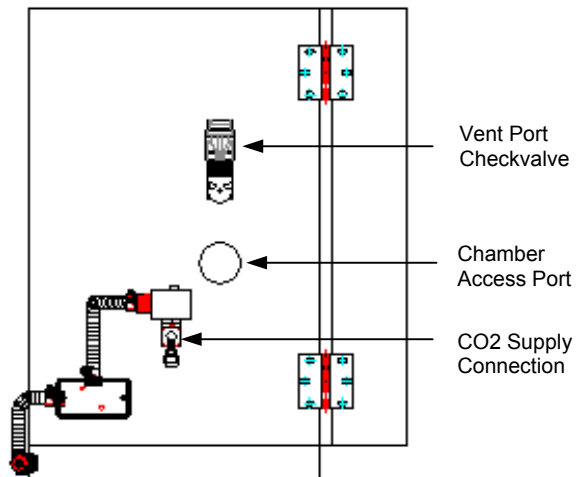

CO2 Boost Cooling

5.7 Electrical Specifications

18 A, 100 / 120 V, 50 / 60 Hz, 1 PH

Your main power fused disconnect switch should be fused at 20 Amps.

5.8 Power Connection



Warning! Before making the power supply connection to your unit, you must perform the following procedure:

1. Verify the power supply voltage rating established for your chamber (listed above). The voltage rating is also found on the serial tag on the side of the oven. Note the rated value here: _____
2. Measure and record the intended voltage source. Note the measured value here: _____
3. Reference the "Line Voltage Min/Max Tables" below. Verify that the power supply voltage source you measured and recorded is within the minimum and maximum allowable operating voltages for your chamber rating. If it is not within this operating range, **do not make the power connection!** Otherwise, erratic operation and damage may occur to your equipment, which may void your warranty. If you have any questions, please call the Lunaire Service Department.

Important! One of the most common causes of equipment malfunction is low line voltage as the power source to the unit. Ordinarily in this condition, the heat output would be reduced and the system's motors would operate erratically, eventually overheat, and shut down. You must be certain that your equipment is connected to a circuit with an adequate voltage and current source. An oversupply voltage would also cause erratic operation and eventual shutdown, or damage to your equipment.

- 60 HERTZ SUPPLIES - LINE VOLTAGE MIN. / MAX. TABLE		
Nominal Voltage	Minimum Voltage	Maximum Voltage
120	108	127
208	198	218
230	207	253
60 Hz Supply	Operation outside these limits can result in damage to the system's motors.	

- 50 HERTZ SUPPLIES - LINE VOLTAGE MIN. / MAX. TABLE		
Nominal Voltage	Minimum Voltage	Maximum Voltage
200	180	220
220	198	242
50 Hz Supply	Operation outside these limits can result in damage to the system's motors.	

For CE European Marked Chambers Only: Chamber Fuse Type and Rating

1FU (Qty. 1) Gould Model GDG1/2 .5 A, 250 VAC Time-Lag

Making the Power Supply Connection to the Chamber:

A main power disconnect is not provided with your chamber. We recommend that a fused disconnect switch on a separate branch circuit be installed as the power source to your chamber, in accordance with all national and local electrical codes. Reference your Electrical, or Power Schematic for all electrical requirements.

The power connection is made via a cord and plug for standard units. Connect the plug to a receptacle that has the appropriate power supply on a branch circuit of its own. **If the TempGard IV option is included, refer to the “Alarm and Shutdown Circuit - TempGard IV” section for the connection procedure.**

For special units that have the power supply hard-wired to the chamber, connect incoming lines to the main input connections provided in the control section.



Warning! High Accessible Current – An Earth connection is essential before connecting the power supply. Make sure equipment is properly grounded in accordance with all codes.

5.9 Application of Power

- ◆ Before energizing any equipment, make a visual inspection for loose components, electrical connections, fittings, etc. Shut all operating switches to the “OFF” position before energizing.
- ◆ Have trained personnel start and check out the equipment before its first cycle.

Motor Rotation Check: Units with three phase motors must be checked to insure proper motor rotation. A red arrow is located on the motor housing to show proper rotation. If it is opposite, shut down the oven and disconnect the main power supply source. Perform **Lock-Out / Tag-Out Procedures** established by your company. Reverse two of the line feeds to obtain proper operation. Failure to check motor rotation may result in **DAMAGE TO THE EQUIPMENT** due to opposite airflow, or no airflow.

5.10 Operating With an Active Heat Load

Note: This feature is only available with the TempGard IV option.

When operating with an active heat load, such as introduced by a powered test unit, this heat must be removed or the chamber temperature will rise. The internal logic of the controller will automatically turn on the refrigeration system to maintain a set temperature. Although a cooling system failure is not likely to occur, it is always a possibility when mechanical systems are used. In the event of a cooling system failure that results in an out of limit over temperature condition, one or more of the system safeties will remove power from the system. However, heating will continue if power remains applied to the active load. To guard against this continued heating, the product should be powered through the spare contacts of the Master Contactor (CON) from the TempGard IV circuitry. This is described in the Alarm And Shutdown Circuit section.

6.0 AIR CIRCULATION SYSTEM

Tenney Junior Test Chambers are provided with an efficient airflow system that maintains maximum temperature uniformity.

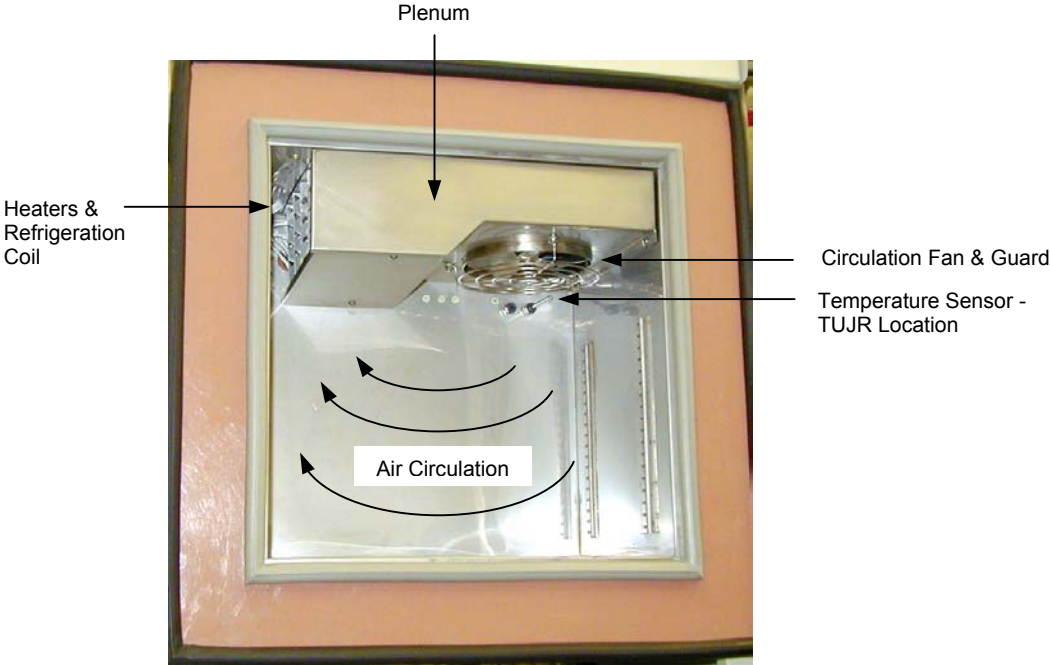

Air Circulation

Chamber air is conditioned in the ceiling plenum where the circulation fan, heater elements, and refrigeration coil are located. A propeller type fan driven by an externally mounted motor generates airflow. The plenum cover prevents direct heat radiation to the workspace.

Process air is drawn up into the left side of the plenum. It flows through the heater elements and the refrigeration coil and is discharged by the fan down into the workspace. The cycle repeats. A 100 ohm Platinum RTD sensor mounted below the fan measures discharge air temperature.



Conditioning Section

7.0 TEMPERATURE CONTROL

7.1 Controller Features

Temperature conditions are controlled with the standard profiling type Watlow 942 Controller. The alternate Watlow F4 Controller may be used for more demanding applications. Both controllers are described below.

Watlow 942 Controller:

The Watlow 942 is a profiling type ¼ DIN controller with ramping and auto-tuning control. The following main features are employed.

- ◆ Single Channel
- ◆ Profiling: Multiple Profiles, 24 Steps Max.
- ◆ Automatic & Manual Control
- ◆ 1 Input: Universal Type (RTD is Std.)
- ◆ 2 Control Outputs: Time Proportioned, or On / Off Control
- ◆ 2 Auxiliary Outputs - Optional: 1 or 2 Events, or 1 or 2 Alarms, or 1Retransmit w/Alarm, or w/Event
- ◆ Guaranteed Soak - Standard
- ◆ Communications: Serial - Optional

Watlow F4S Controller:

The Watlow F4S is a profiling type ¼ DIN controller with ramping and auto-tuning control. The following main features are employed.

- ◆ Single Channel
- ◆ Profiling: Forty Profiles, 256 Steps
- ◆ Automatic & Manual Control
- ◆ 1 Input: Universal Type (RTD is Std.)
- ◆ 4 Digital Inputs
- ◆ 2 Auxiliary Analog Inputs - Optional
- ◆ 2 Control Outputs: Time Proportioned, On/Off, or 4-20 ma
- ◆ 2 Alarm Outputs
- ◆ 8 Digital Event Outputs
- ◆ 2 Retransmit Outputs - Optional
- ◆ Communications: EIA-232 and EIA-485 with Modbus RTU protocol

DATA COMMUNICATIONS - WATLOW 942

As an option, your chamber may include data communications with the main controller's serial port. When employed, a Data Communications manual will be included in the Supplemental Instructions Section. As a reference, the available data types are listed and briefly described below.

RS232C / RS423A: Both interfaces are compatible and use 3 wires: a single transmit wire; a single receive wire; and a common line. The maximum wire length is 50 feet. Only a single chamber may be connected to your computer. Data signals are measured as plus and minus 12 Volts to common with RS232C, and plus and minus 5 Volts to common with RS423A.

RS422A: This interface uses 5 wires: a transmit pair; a receive pair; and a common line. Up to ten chambers may be connected to your computer on a multi-drop network up to 4,000 feet long. Data signals in each pair are measured as a plus or minus 5 Volt differential.

EIA-485: This interface uses only 2 wires. Both wires are used for transmitting and receiving data, and therefore, only one device may talk at a time. Up to 10 chambers may be connected to your computer on a multi-drop network up to 4,000 feet long. Data signals are measured as a plus or minus 5 Volt differential. An EIA-485 card must be installed for signal conversion.

IEEE-488: This is a parallel multi-drop interface with several control and data lines. Each device connected must be set to a unique address. Data from other test devices may also be collected. An IEEE-488 to serial converter card must be installed. Maximum cable length is approx. 33 ft.

DATA COMMUNICATIONS - WATLOW F4

Data communications utilizes EIA-232 and EIA-485 serial interface with Modbus RTU protocol. Modbus RTU enables a computer or PLC to read and write directly to registers containing the controller's parameters. These data interface types are briefly described below.

Controller Configuration:

The pre-programmed controller configuration for your chamber is documented in the Test Report, which is located in the Supplemental Instructions Section. Refer to the controller's user manual for more information.

Important! The configuration set-up is mainly provided for your reference. Not all of the parameters shown apply to your chamber. Changes to some of the set-up parameters may drastically affect your chamber performance and void your warranty. Contact the Lunaire Service Dept. before attempting any changes.

7.2 Watlow 942 Control Functions:

The Main Power switch 1SS must be turned ON to enable the conditioning control circuitry. 1SS will also turn on the chamber conditioner fan.

The following descriptions detail the functions of the various outputs. Event outputs (user entered) are provided mainly for special applications. These features are normally described in the "Options" section of the manual.

- HEAT CONTROL -

1C - 01 -- This time proportioned output will trigger triac 1TRC to conduct and provide power to the electric heaters.

- COOLING CONTROL -

1C - 02 -- This On/Off output will trigger triac 2TRC to conduct and energize the refrigeration system. The high stage compressor will immediately start. The low stage compressor will start after a slight delay from the Low Pressure Cut-In Switch PS2.

- EVENT OUTPUTS - (Optional)

1C - 03 -- This is Event No. 1, which serves as a compressor shutoff when going from a very low to a vary high setpoint. In this scenario, any cycling of the compressors is not desired, and a heat overshoot is tolerated. 1C-03 contacts are normally closed. They will open when the event is turned ON to disable the Cooling Control Output.

For Model XXXX, SN xxxxx Only:

Event No. X -- Output 1C-0x:

WATLOW 942 COMPRESSOR TURN-ON LOGIC

In determining when to turn the refrigeration system On or Off, the controller's logic will compare the following signals and setpoints.

1. Actual Chamber Temperature
2. Setpoint Temperature
3. Hysteresis
4. Deadband

Hysteresis (**HYS**) and deadband (**db**) are parameters entered at the factory. Hysteresis is the temperature change necessary to change the output from full ON to full OFF, and is detailed in the Setup Menu section in the Watlow 942 Manual. Deadband is the span in which Output 1C-02 will remain ON below the controller's low setpoint, and is detailed in the Operation Menu section of the Watlow Manual. **HYS** and **db** are entered in degrees Celsius. Deadband is always entered as a (-) minus. The logic is:

- ◆ Measured temperature rises above setpoint: Refrigeration turn-on = hysteresis minus deadband.
- ◆ Measured temperature falls below setpoint: Turn-on is always above setpoint.
- ◆ Turn-off is always below setpoint: Turn-on is always above setpoint.

Example Settings For HYS and db: See Next Page

Example Settings For HYS And db

	HYS	db	Turn-On (Above SP)	Turn-Off (Below SP)
<u>Standard</u>	4	-3	1	3
	5	-3	2	3
	5	-1	4	1
<u>No Good</u>	3	0	3	0

Chambers are shipped with **HYS** = 4, and **db** = - 3, as shown on the top line in the above examples. It is unlikely a change to these settings will be required. Fortunately, these settings are not subject to “cold start” default, and will remain valid after a power interruption. They are held in EEROM, not battery-backed RAM.

7.3 Watlow F4 Control Functions (Alternate Controller): The Main Power switch 1SS must be turned ON to enable the conditioning control circuitry. 1SS will also turn on the chamber conditioner fan.

- HEAT CONTROL -

Output 1A -- This time proportioned output will trigger triac 1TRC to conduct and provide power to the electric heaters.

- COOLING CONTROL -

Dig. Out #8 -- This digital On/Off output will energize solid state relay SSRx and a control relay, which triggers triac 2TRC to conduct and provide power to the entire refrigeration system. The high stage compressor will immediately start. The low stage compressor will start after a slight delay from the Low Pressure Cut-In Switch PS2.

Note: Digital Output No. 8 serves as a Compressor Control output, which can save wear on a compressor and prevent it from locking up from short cycling. Compressor On % Power sets the power level that will switch this output (compressor & control circuitry) on. Compressor Off % Power sets the power level that will switch the compressor off.

The compressor(s) will not turn on until the output power exceeds the Compressor On % Power for a time longer than the Compressor On Delay. The compressor will not turn off until the output power exceeds the Compressor Off % Power for a time longer than the Compressor Off Delay.

To Clear an Alarm or Error:

In an alarm condition, an alarm message will appear on the Main Page (if this option has been selected on the Setup Page). To silence it, move the cursor to the alarm message and press the Right Key >. A pop-up message will confirm the silencing of the alarm, and the indicator light will go off.

When the condition causing the error or alarm is corrected, return to the error or alarm message on the Main Page, and press the Right Key again. A pop-up message confirms the alarm is unlatched.

Cascade Temperature Control (Optional):

Note: Tenney chambers are set up to run in the “**No Cascade**” mode because of the many variations in customer products that require special tuning with this option.

8.0 HEATING DESCRIPTION

Heating of the chamber is accomplished with the use of open air low mass nichrome wire heating elements. These elements have low thermal lag and provide rapid response to the controller's demands. The elements are mounted in the plenum conditioning section. This isolates them from the workspace and prevents direct radiation to the product. The heater bank is rated 500 Watts, consisting of two 250 Watt elements.

Heater Control:

The heaters are controlled by a time proportioned output from the main controller. This output triggers a triac to conduct and provide power to the elements.

Note: The Boost Heat option may be provided to increase the rate of heating. Reference the "Boost Heat" option section for details.

9.0 CHAMBER OVERTEMPERATURE PROTECTION

9.1 Overview

A thermal cutoff (labeled as Heat Limiter HL) is provided to protect the chamber against overtemperature conditions. This is an axial leaded one-shot protection device, which is connected in-line with the mains power supply Neutral Line, directly to the heater rack. The thermal cutoff will permanently open and remove power from the heater elements when the surrounding air temperature reaches 240°C. **Once the thermal cutoff opens, it must be replaced.**

Note: The thermal cutoff is not used when the Boost Heat option is employed. This option uses a Watlow 147 Limit Controller for overtemperature protection. Reference the "Boost Heat" option section for details.



Thermal Cutoff

Thermal Cutoff is installed in the Neutral Line, and is wrapped in glass cloth electrical tape.

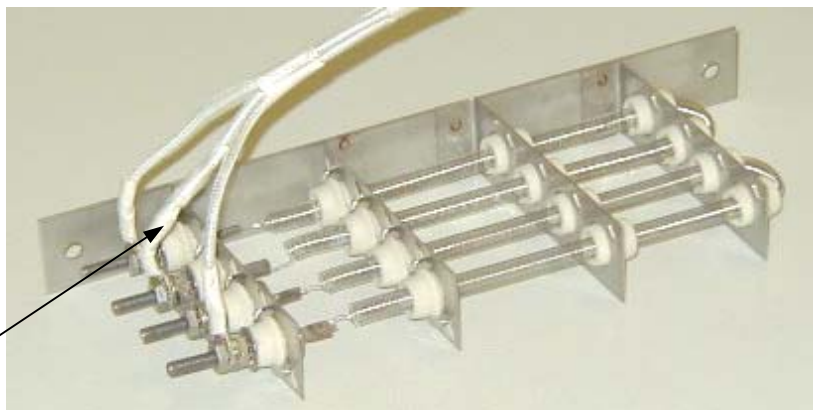

Heater Element Rack

9.2 Thermal Cutoff Replacement Procedure



WARNING! Before replacing the thermal cutoff, you must disconnect your power supply cord and plug from the power supply receptacle. If your chamber is hard wired, you must open the closest main power disconnect switch. Lockout / Tagout all electrical power to the chamber before proceeding. Read the description below before attempting to replace this device.

1. Push in the RTD sensor probe with your finger towards the wall of the chamber.

Important! DO NOT push the RTD probe all of the way into the probe fitting. Leave between 1/2" to 3/4" sticking out.

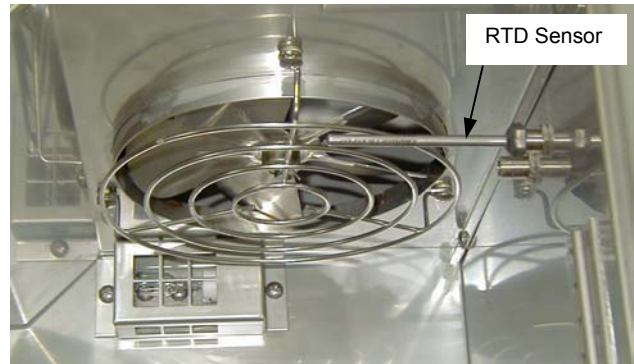

TJR RTD Location

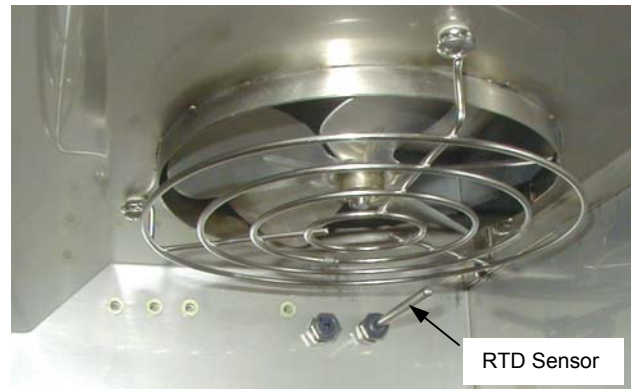

TUJR RTD Location

2. Remove the conditioner plenum cover by removing the four mounting screws. Be careful not to hit the fan blade or the RTD probe when dropping the cover down.

Note: In this photo, the RTD probe is not pushed in.

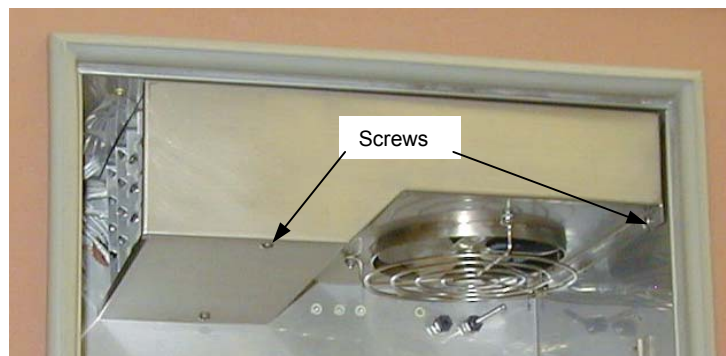

Plenum Cover Removal

- Remove the two heater rack mounting screws and drop the rack to the bottom of the chamber.

Note: The back mounting screw is in a confined area.

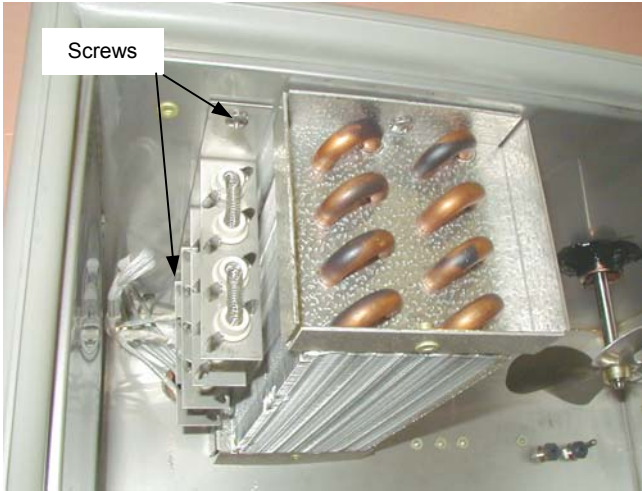

Heater Rack Removal #1



Heater Rack Removal #2

- The thermal cutoff is installed in-line with the Neutral Line. It is wrapped with glass cloth electrical tape, Type 3M Scotch 27 (Lunaire P/N 914050). One side is connected to the Neutral Line with a butt crimp connector. The other side is connected to the heater rack with a ring terminal, and is secured with an 8/32 nut.

Unwrap the tape and remove the thermal cutoff by cutting it free of the Neutral Line at the butt connector, and by removing the nut on the heater rack.

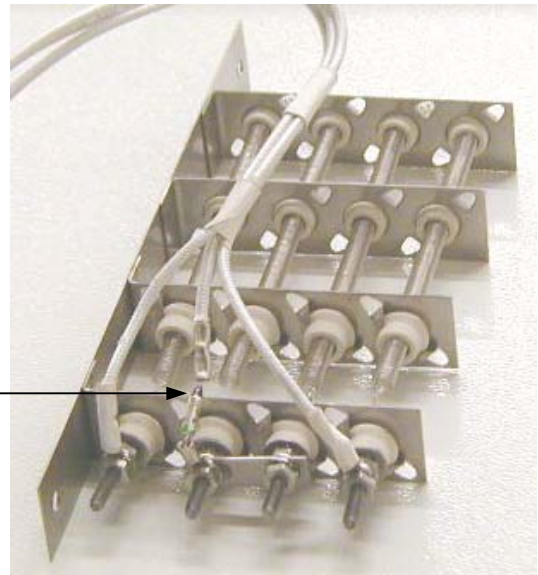

Thermal Cutoff Removal

Replace the unit with a new thermal cutoff, along with the proper butt splice and ring connector. Make sure you wrap the new section properly with glass cloth electrical tape.



As you install the new thermal cutoff and put the plenum back together, **take great care in your replacement procedure!** Make sure all connections are secure!

10.0 CASCADE REFRIGERATION SYSTEM

Basic System Description:

This is a multiple refrigeration system consisting of a low stage and a high stage system. These systems are integrated to efficiently provide very low temperature levels. This is achieved by utilizing a cascade condenser in the low stage, where low stage refrigerant is cooled and condensed by the high stage refrigerant. The cooled low stage refrigerant now has greater cooling capacity in the chamber evaporator coil. An air-cooled condenser is used in the high stage.

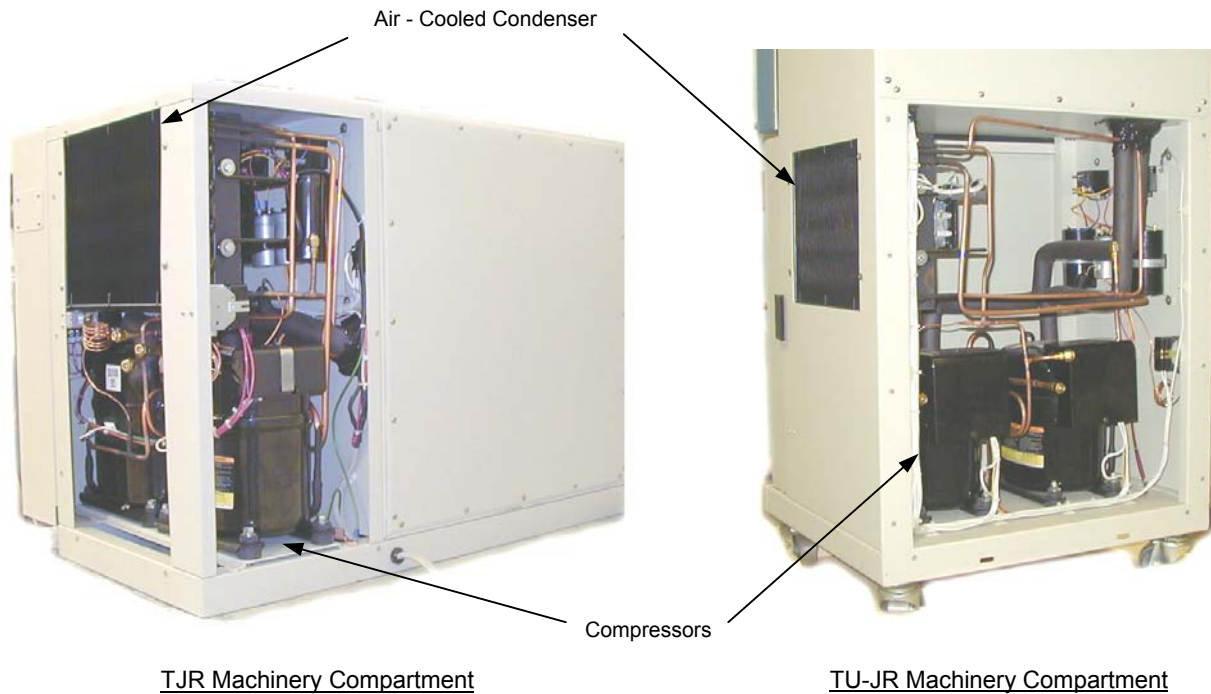

Capillary Tube Control Description:

This system employs capillary tube type refrigerant control. A long length of seamless copper tubing with a small internal diameter is used to feed the evaporator coil. The tube acts as an automatic throttle in controlling refrigerant pressure and flow to the evaporator. With the compressor running, a high pressure is maintained on the inlet to the capillary tube, and a low pressure is maintained in the evaporator. The pressures will balance when the compressor is turned off. This places a low starting load on the compressor motor when turned back on. A fine filter or filter-drier is provided at each capillary tube inlet to remove moisture and dirt from the refrigerant.

Low Stage Description

The low stage system includes the compressor, the cascade condenser, an expansion tank, and the evaporator coil located in the chamber conditioning section.

Refrigerant flow in the low stage is from the compressor as a hot compressed gas and then through a desuperheater where most of the heat of compression is removed. The desuperheater is part of the high stage air cooled condenser. As a cooled gas, it then flows to the cascade condenser where it condenses to

liquid form by heat exchange with circulating high stage refrigerant. The liquid refrigerant flows through a drier assembly, and is metered through a capillary tube to the evaporator cooling coil in the chamber conditioning section. Warm chamber air circulates through the cooling coil, and heat exchange occurs as the liquid refrigerant boils, vaporizes, and absorbs heat. The vaporized refrigerant returns to the compressor through the suction line. The cycle is repeated.

High Stage Description

The high stage system includes the compressor, an air cooled condenser, and a suction line accumulator to guard against liquid refrigerant return to the compressor.

Refrigerant Flow:

Refrigerant flow in the high stage is from the compressor as a hot compressed gas, to the air cooled condenser where the gas cools and condenses to liquid form. It then flows to the cascade condenser, being metered by a capillary tube. In the cascade condenser, high stage refrigerant absorbs heat from the circulating low stage refrigerant. As it absorbs heat, the high stage refrigerant boils and vaporizes. It then returns to the compressor through the suction line accumulator SLA. The cycle is repeated.

Safety Devices

Low Pressure Cut-In Switch PS2:

The low stage compressor will start after a slight delay from the Low Pressure Cut-In Switch PS2, which monitors the suction pressure in the high stage compressor. This switch will close when the suction pressure reaches 20 PSIG. This delay prevents both compressors from hitting the power line at the same instant.

High Pressure Cut-In Switch PS1:

An Artificial Loading solenoid valve SV will be energized by the High Pressure Cut-in Switch PS1, when low stage compressor head pressures reaches 280 PSI. This action dumps refrigerant into the expansion tank for storage until the pressure drops to 240 PSI.

Compressor Motor Overloads:

A motor overload protective device is installed in the windings of each compressor, which will open if the motor windings exceed a preset temperature. Probable causes are insufficient flow across the motor due to a refrigerant loss, or a failure of the liquid injection valve provided for suction gas cooling. The motor overload will automatically reset and restart the compressor after the motor has cooled.

NOTE: Please reference the section entitled “Servicing Cascade Refrigeration Systems” for a more detailed description.

11.0 ALARM and SHUTDOWN CIRCUIT - TempGard IV (Optional)

11.1 System Description

A comprehensive alarm and shutdown circuit may be provided for protection against product over/under temperature. This optional feature utilizes a Watlow 93 Controller configured as a TempGard IV temperature protector. The Watlow 93 is a microprocessor based controller that incorporates programmable high and low temperature limits. A 100 ohm Platinum RTD is used for temperature measurement. It is placed near the plenum in the downstream airflow, which is the most responsive area of the chamber. An Electrical Schematic of the TempGard IV feature is included with this manual.

In the Model TUJR, the TempGard IV feature is integrated directly into the chamber power scheme. The chamber comes equipped with a single power supply cord that plugs into a power supply receptacle.

In the Model TJR, the TempGard IV feature is enclosed in a separate control box and is mounted on top of the unit. For shipping purposes, the TempGard control box is removed from the top of the unit and placed inside the chamber workspace. The RTD wire that runs from the chamber thru the BX conduit and into the TempGard control box is disconnected. The chamber power supply cord is unplugged from the TempGard receptacle. Reference the following section for the complete wire and cable hookup procedure.



TempGard IV Control Box

TJR - TempGard IV

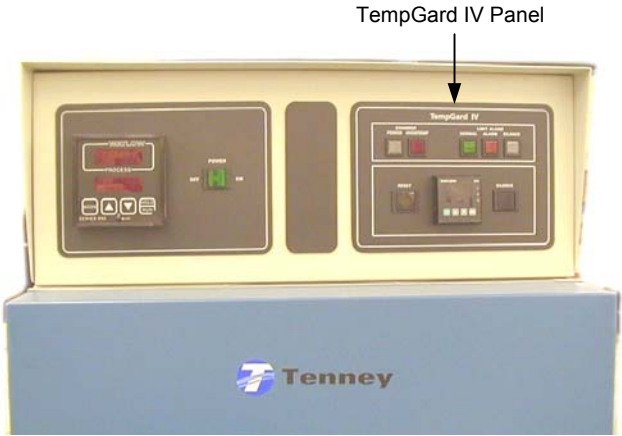

TempGard IV Panel

TUJR - TempGard IV



TempGard IV Panel

11.2 Special Hookup of TempGard IV for Model TJR ONLY

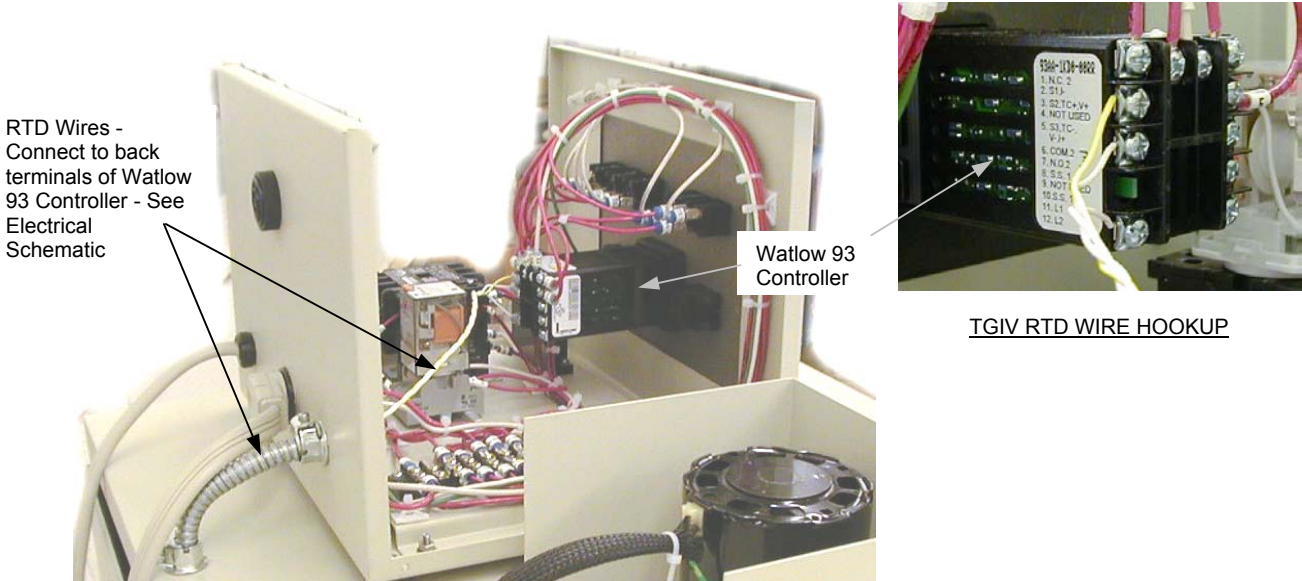

RTD Connection on Watlow 93 TempGard IV Controller

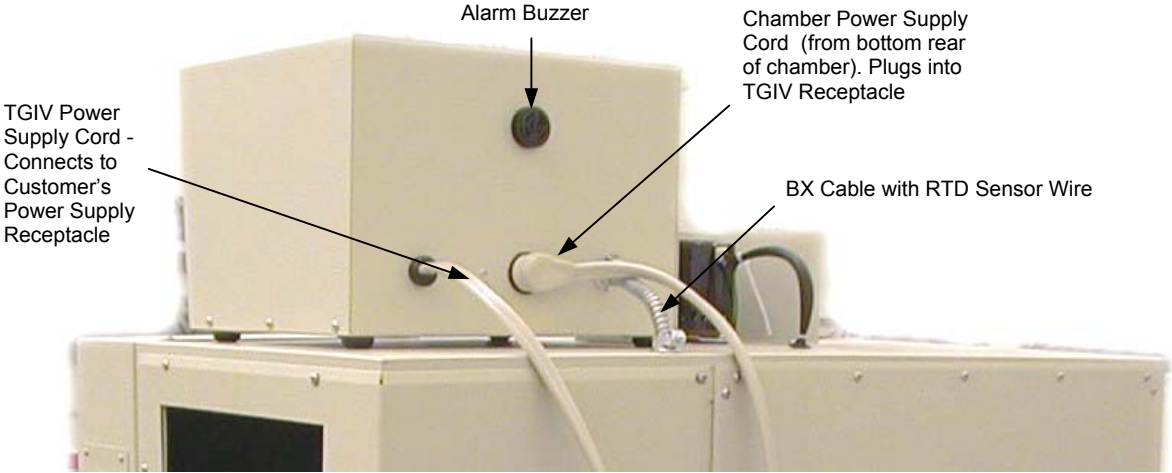

TJR - TempGard IV Connection - Rear View

TempGard IV / Chamber Power Supply Configuration: Connect the TGIV power supply cord to your power supply receptacle. Connect the chamber power supply cord to the receptacle on the back of the TGIV enclosure.

11.3 Circuit Operation

When chamber temperature is within the selected setpoints, the white NORMAL light 2LT is illuminated and Master Contactor CON is energized. The contacts of CON provide power to the conditioning control circuitry.

Note: A spare set of CON contacts is provided for the customer's closure. It is recommended that these contacts be used to energize an active heat load if utilized.

When a preset temperature limit is reached within the Watlow 93, the alarm contacts TG will open and deenergize CON, which causes the following to occur.

- ◆ Power is removed from the main temperature controller and conditioning circuitry.
- ◆ Alarm buzzer sounds.
- ◆ Alarm and Chamber Overtemp lights on the TempGard IV panel will illuminate. The lower display of the Watlow 93 will blink with the corresponding alarm message, e.g., AHI and HI, or ALO & LO.



WARNING! When Master Contactor CON is deenergized due to an alarm condition, power is only removed from the chamber circuitry. The instrumentation and alarm circuitry in the TempGard IV control box will still be energized!

A Silence switch 4SS is provided to disable the alarm buzzer while corrective action is taken. When 4SS is activated, the white Silence light 5LT will illuminate. When conditions are corrected, you must reset the chamber power system.

RESET:

To reset the alarm circuitry and the main controller control circuitry, press the Chamber Power switch on the TempGard IV panel. (The Power switch also serves as a Reset switch.)

Important: If the alarm buzzer was disabled and the system was successfully reset with the Power switch 2SS, the alarm buzzer will now sound to alert the operator to place the Silence switch 4SS in its off position.

A 1.5 second timer TC is included in the reset circuit to provide for automatic start when power is applied to the system. This avoids the need for a manual reset each time that power is removed and reapplied.

The configuration for the TempGard IV option is detailed in the section entitled "TempGard IV Alarm Setpoint Entry", which follows. Reference the Watlow 93 user manual for complete details of the controller.

11.4 TempGard IV Alarm Setpoint Entry

The purpose of this section is to explain how to set your low & high temperature alarm setpoints with the optional TempGard IV. This feature is part of the optional Alarm And Shutdown Circuit described earlier.

Normal Conditions: When conditions are within the alarm setpoints, the upper display of the Watlow 93 will indicate the process temperature (normally in degrees Celsius), and the lower display will be blank. Temperature measurements are made with a 100 ohm platinum RTD sensor.

Alarm Setpoint Entry Procedure: Disregard parameters not listed. (You will be in the Operation Menu.)

1. Press the Advance Key (key with two curved arrows) to scroll to the Alarm Low (ALO) parameter (lower display). Use the Up / Down arrow keys to set the desired low alarm setpoint (upper display).
2. Press the Advance Key to scroll to the Alarm High (AHI) parameter (lower display). Use the Up / Down arrow keys to set the desired high alarm setpoint (upper display).
3. After setting the low and high limit values, continue scrolling with the Advance Key until the Alarm Low setpoint that you just entered appears in the lower display. It will go blank after a few seconds.

Note: On the old style Watlow 965 Controller, you must press the “M” key to scroll in any menu.

Alarm Conditions: When an out of limit condition occurs, the lower display will flash “HI” or “LO”.

Important: When the alarm condition has cleared, the **TGIV alarm will automatically reset**. You must then reset the chamber control circuitry by pressing the chamber Reset button. For Models TJR / TUJR only, cycle the Chamber Power switch. These switches are on the TGIV panel.

Setup Menu: The Setup Menu is provided for reference only. It has already been configured. **Do not change any values unless circumstances demand it**, such as when you need to change controllers.

To access the Setup Menu, press the Up Arrow and the Down Arrow keys simultaneously. Setup parameters are shown in the lower display. Parameter values appear in the upper display. Press the Advance key to scroll through the menu. Values for the Low Range Limit (rL) and the High Range Limit (rH) are the low and high temperature ratings of your chamber, minus and plus 4 degrees, respectively.

SETUP MENU for WATLOW 93 - TEMPGARD IV			
Parameter	Value	Parameter	Value
LOC	1	Ot2	PrA
In	rtd	HSA	1
dEC	(default)	LA _t	Nla
C - F	C	SIL	(default)
rL	Low Limit minus 4 deg.	rtd	Din
rH	High Limit plus 4 deg.	rP	OFF
Ot1	ht	P L	100
HSC	(default)	dSP	Pro

12.0 BOOST HEAT (Optional)

As an option, your chamber may be equipped with the boost heat feature, which includes extra heaters to provide rapid increases in temperature. This feature is available in either a 500 W, or 1000 W version. The boost heat will automatically turn on if a preset time delay relay times out, indicating that the desired temperature has not been achieved.

As the heat output of the main controller energizes the main heater bank, it will at the same time energize time delay relay TC, which is set for three minutes. When this relay times out it will energize mercury relay MR, which provides power to the boost heaters.

With this option the Heat Limiter fuse is not used. In its place, a Watlow 147 Limit Controller 1TS is used to monitor and protect the chamber against an overtemperature condition. This controller is an open board type with an adjustable dial and a calibrated scale for selecting the high limit temperature setpoint. It is installed inside the main control panel. A red LED on the Watlow 147 will illuminate in an alarm condition. A Type T thermocouple is used for temperature measurement. **Note:** The high limit is preset at the factory and should **never** be changed.

When the temperature is below the preset limit, 1TS contacts will be closed to energize contactor BHCON. Separate contacts of BHCON are wired in series with both the existing heater elements and the boost heater elements. When the Watlow 147 detects an overtemperature condition, 1TS will open to deenergize BHCON and all heaters.

Reference the Boost Heat Electrical Schematic for more details.

13.0 DRY AIR PURGE SYSTEM (Optional)

Note: Refer to the Installation Instructions Section for supply and connection type specifications.

A Dry Air Purge System may be provided to purge the chamber of moisture or undesirable process vapors. A heatless desiccant dryer is operated with a compressed air supply to produce a source of dry air.

General Description:

The dryer is a twin tower heatless desiccant type that is self-regenerating. Each desiccant tower (chamber) contains a compression packed molecular sieve. As the compressed air passes through the sieve, moisture is picked up by the desiccant. The dried air is released through an outlet port and injected into the test chamber's conditioning airflow through solenoid valve ASOL. A small portion of the dried air is passed through a sized orifice to the other tower to purge the desiccant of moisture collected during the previous cycle. There are four distinct phases of the heatless dryer where the compressed air is alternately cycled and dried in each of the two desiccant towers. Integral timers and solenoid valves within the dryer control this operation.

Operation:

The system is activated by an Event Output from the main controller (or by a manual switch). To use the system, the Event must be turned ON. Reference the Event Label on the side of the chamber or your Test Report for the Event Number assigned to this feature. When the system is activated, both the dryer and the Dry Air solenoid valve ASOL will energize.

Note: Your equipment configuration may be slightly different from what is shown.



Heatless Desiccant Dryer

14.0 GN2 PURGE AIR SYSTEM (Optional)

Note: Refer to the Installation Instructions Section for supply and connection type specifications.



Warning! Gaseous nitrogen displaces oxygen. Make sure the area surrounding the chamber is well ventilated to dilute the gas vented from the chamber vent port checkvalve!

General Description:

As an option, your chamber may be equipped with a GN2 Purge System to provide an inert atmosphere inside the chamber. An inert atmosphere minimizes the buildup of moisture and prevents condensation on the product under test. Eliminating oxygen in the chamber air helps prevent corrosion of the product. Gaseous nitrogen is injected into the chamber through a header pipe in the conditioning plenum. It readily mixes in with the circulating process air.

Operation:

The system is activated by an event output from the main controller (or by a manual switch). To use the system, the Event must be turned ON. Reference the Event Label on the side of the chamber or your Test Report for the Event Number assigned to this feature.

When activated, the event output will energize and open the GNSOL solenoid valve to permit the injection of GN2. A metering valve and flowmeter is supplied as part of the system to establish the design purge flow. The valve should be adjusted until the indicated flow is about 300 cubic feet per hour.

Note: Your equipment configuration may be slightly different from what is shown.

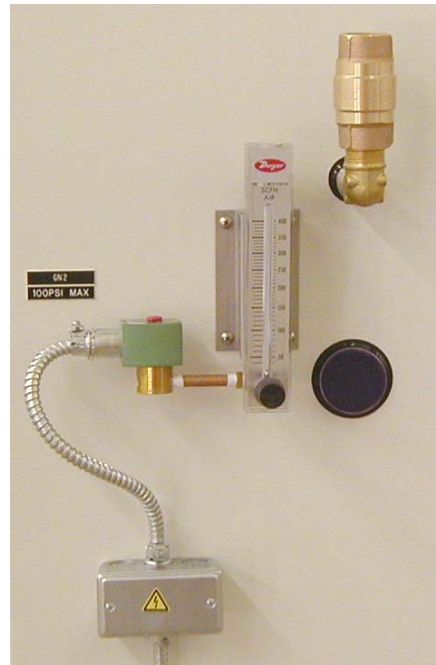

GN2 Purge System

15.0 LN2 BOOST COOLING SYSTEM (Optional)

Note: Refer to the Installation Instructions Section for supply and connection type specifications.



Warning! Gaseous nitrogen resulting from vaporized LN2 displaces oxygen. Make sure the area surrounding the chamber is well ventilated to dilute the gas vented from the chamber vent port checkvalve!

General Description:

The LN2 Boost Cooling System option may be provided to increase the rate or limit of cooling beyond the means of the refrigeration system. Boost cooling is achieved by injecting liquid nitrogen into the chamber through a port located on the bottom left side. LN2 has a boiling point of -196 degrees Celsius (-320 deg. F). As the liquid sprays out of the port, it vaporizes and absorbs chamber heat while it mixes with process air. A small metal deflection flange is mounted about an inch away from the LN2 port to deflect any liquid nitrogen spray from hitting the product before it vaporizes.

LN2 systems are provided with a manually set flow adjustment valve, which permits the adjustment of nitrogen flow to avoid incomplete evaporation at varying LN2 supply pressures. As the chamber cools to the extreme cold temperature limit, complete evaporation of liquid nitrogen may not occur if the supply pressure is allowed to drop.



Important! Incomplete evaporation will cause droplets of liquid to fall to the floor and may promote puddling. If enough liquid accumulates, it may seep towards the chamber door gasket. Do not allow LN2 to contact the door gasket. Exposure to LN2 will damage the gasket and violate the seal.

Operation:

The system is activated by an event output from the main controller (or by a manual switch). To use the system, the Event must be turned ON. Reference the Event Label on the side of the chamber or your Test Report for the Event Number assigned to this feature.

Once the system is enabled with the event output, the controller's time proportioned Full Cooling output will energize a solid state On-delay timer. If the Full Cooling output remains on longer than ten seconds, the timer will time out and energize the LN2 Injection solenoid valve SOL. This valve will open to permit the flow of LN2 into the chamber to boost the cooling rate. As soon as the Full Cooling output turns off, the timer output will open to deenergize SOL and shut off the flow of LN2.

Note: Your equipment configuration may be slightly different from what is shown.



LN2 Boost Cooling

16.0 CO2 BOOST COOLING SYSTEM (Optional)

Note: Refer to the Installation Instructions Section for supply and connection type specifications.



Warning! Carbon Dioxide gas displaces oxygen. Make sure the area surrounding the chamber is well ventilated to dilute the gas vented from the chamber vent port checkvalve!

General Description:

The CO2 Boost Cooling System option may be provided to increase the rate of cooling beyond the means of the refrigeration system. Boost cooling is achieved by injecting liquid carbon dioxide into the chamber through an orifice within an injection port. There is no flow adjustment valve for the supply. CO2 has a boiling point of -78.5 degrees Celsius (-109.3 deg. F). As the liquid sprays out of the orifice, it immediately vaporizes and absorbs chamber heat while it mixes with process air.

Operation:

The system is activated by an event output from the main controller (or by a manual switch). To use the system, the Event must be turned ON. Reference the Event Label on the side of the chamber or your Test Report for the Event Number assigned to this feature.

Once the system is enabled with the event output, the controller's time proportioned Full Cooling output will energize a solid state On-delay timer. If the Full Cooling output remains on longer than ten seconds, the timer will time out and energize the CO2 Injection solenoid valve SOL. This valve will open to permit the flow of CO2 into the chamber to boost the cooling rate. As soon as the Full Cooling output turns off, the timer output will open to deenergize SOL and shut off the flow of CO2.

Note: Your equipment configuration may be slightly different from what is shown.

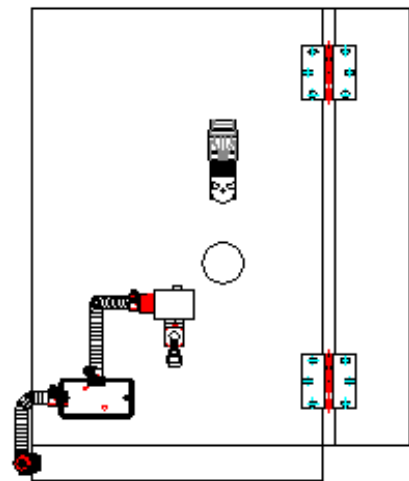

CO2 Boost Cooling

17.0 LinkTenn32 SOFTWARE (Optional)

LinkTenn32 is a Microsoft Visual Basic Software application designed for the Microsoft Windows™ family of PC Operating Systems. LinkTenn32 utilizes a Multi-Document Interface (MDI) familiar to Windows™ software applications so more than one Environmental Chamber Window can be used at a time. LinkTenn32 provides centralized remote monitoring and control of multiple process controllers simultaneously. LinkTenn32 supports the following controllers: **Watlow 942 & F4, Lunaire VersaTenn III, IV, and V Controllers** . The major features provided include:

- ◆ Interactive remote control and monitoring.
- ◆ Alarm reporting and notification via Email or Fax.
- ◆ User-friendly profile program editor.
- ◆ Logging, printing and graphing of process data.
- ◆ Exporting of logging history data via an ASCII comma separated values (CSV) file for easy import into Microsoft Excel or any analysis package that accepts comma separated values (CSV) file format.

The minimum hardware requirements for LinkTenn32 are as follows:

- ◆ One of these Microsoft Windows™ PC Operating Systems: Windows 95, 98, 98 Special Edition, NT 4.0 Service Pack 6a, 2000 Service Pack 2
- ◆ A Pentium Processor 233 MHz or better
- ◆ 128 MB Ram plus 32 MB for each simultaneous chamber session
- ◆ 40 MB hard disk space
- ◆ One serial port
- ◆ One National Instruments GPIB IEEE Interface (Optional)
- ◆ One 10/100 Ethernet card using TCP/IP (Optional)
- ◆ Printer (Optional)
- ◆ Fax Modem (Optional)

Example Screens:

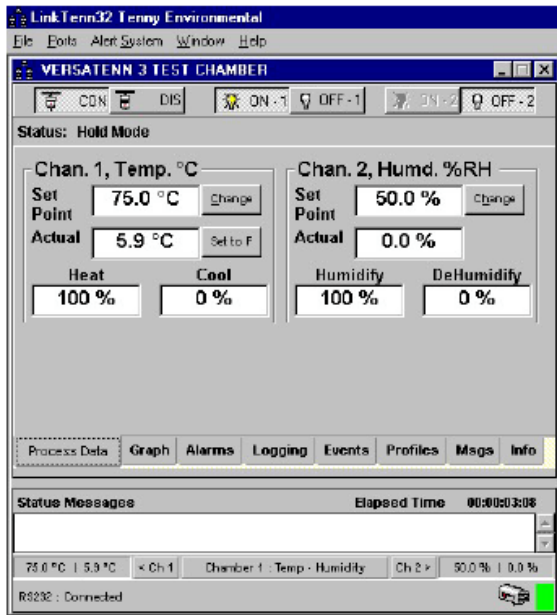

LinkTenn32 - 2 Channel VersaTenn III Screen

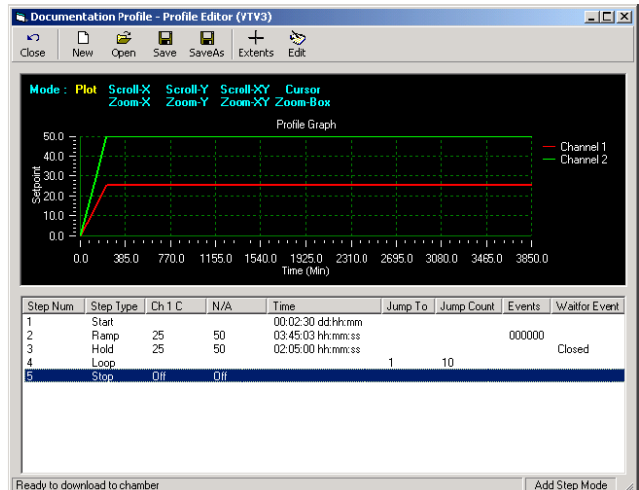

LinkTenn32 Sample Graph Screen - 2 Channel

18.0 CHART RECORDER (Optional)

As an option, your chamber may be provided with either a circular or strip type chart recorder to record temperature versus time. This recorder is typically a one-pen type, which also digitally displays the process value. A 100 ohm platinum RTD is used for temperature measurement. It is placed in the discharge air of the chamber plenum.

The recorder configuration is documented in the Test Report, which is located in the Supplemental Instructions Section. Reference the recorder's user manual for a detailed operation of the unit.

19.0 SEQUENCE OF OPERATION

Important! Make sure the Installation Instructions have been properly followed before operating the chamber. All switches should be in the OFF position before starting the sequence below.

Chambers Without Watlow 93 TempGard IV Option:

1. Plug the chamber power supply cord into your power supply receptacle. Turn on the power source to the chamber (Customer supplied disconnect, or circuit breaker). The display of the main controller should be illuminated.
2. Load product and make sure the door is securely closed.
3. Enter the desired temperature program, or manual setpoints into the main controller.

Important: Check to see if any features or optional equipment must be turned on with an Event Output from the main controller. If an Event Output were supplied, a **Controller Event Output Label** with the Event Output listing would be installed on the side of the chamber. Event Outputs are described either in one of the various “Option” sections, or in the “Temperature Controller - Conditioning Control Functions” section for unique applications.

Reference the corresponding ‘Option’ section for a description of any optional feature.

4. Close the Power switch on the main controller panel. The switch green ON light should illuminate. The conditioner fan will start, and chamber conditioning will begin.

Chambers With Watlow 93 TempGard IV Option:

1. **For Model TJR Only:** After mounting the TempGard IV box on top of the chamber Make sure you have connected the RTD wires to the Watlow 93 Controller and have reinstalled the top enclosure to the TempGard IV unit.

Plug the chamber power cord into the TempGard IV receptacle, which is located on the back of the TempGard IV enclosure. Plug the TempGard IV power cord into your power supply receptacle. Turn on the power source to the chamber (Customer supplied disconnect, or circuit breaker).

For Model TUJR Only: Plug the chamber power supply cord into your power supply receptacle. Turn on the power source to the chamber (Customer supplied disconnect, or circuit breaker).

2. Press the Chamber Power pushbutton on the TempGard IV panel. The Normal light and the displays of the main controller and the Watlow 93 should be illuminated.
3. Load product and make sure the door is securely closed.
4. Enter the desired temperature program, or manual setpoints into the main controller.

Important: Check to see if any features or optional equipment must be turned on with an Event Output from the main controller. If an Event Output were supplied, a **Controller Event Output Label** with the Event Output listing would be installed on the side of the chamber. Event Outputs are described either in one of the various “Option” sections, or in the “Temperature Controller - Conditioning Control Functions” section for unique applications.

Reference the corresponding ‘Option’ section for a description of any optional feature.

5. Enter the desired high and low limits into the Watlow 93. Refer to the “Alarm and Shutdown Circuit” description for further details.
6. Close the Power switch on the main controller panel. The switch green ON light should illuminate. The conditioner fan will start, and chamber conditioning will begin.

Important Note! For **complete** programming and/or operating instructions on any of the controllers, electrical / mechanical components, or optional equipment, you must refer to their operating manuals included with your Tenney Environmental manual.

20.0 PREVENTATIVE MAINTENANCE



Only qualified service personnel should ever be permitted to perform any service related procedure on this chamber!

Frequency of preventive maintenance procedures depends upon how the facility is used and upon other circumstances. Because of this, a hard and fast schedule of maintenance operations is difficult to present. Indeed, an inflexible schedule might be suitable for one user, but completely inadequate for another. Therefore, we have provided periodic figures when to perform maintenance procedures, based on the average chamber use.

We suggest that you maintain a preventive maintenance log. In this log you will record operating notes, pressures, temperatures, and electric readings. The log is valuable because it will help maintenance and service people by documenting long term trends and by showing parameter levels when the chamber is operating properly.

Since the refrigeration system is sealed and the instruments are solid state, little maintenance is required on the temperature chamber. However, the following preventive maintenance steps are suggested.

20.1 General Maintenance



All interlocks and safety features should be tested periodically for proper operation.

1. For air-cooled refrigeration systems, inspect the condenser coil for dust or dirt accumulation that would impede the flow of air. A dirty condenser will decrease system efficiency and drive up compressor head pressure, causing it to trip out. If necessary, clean with a brush or vacuum cleaner. Frequency of cleaning depends upon the air quality at the chamber.
Period: approx. every 30 days.
2. For water-cooled refrigeration systems, make sure the condenser water supply is according to the specifications listed on the Refrigeration Drawing. If a closed-loop water supply system is not utilized and the water-out port connection is to an open drain, make sure that flow to the open drain is not restricted. Inadequate flow will decrease system efficiency and drive up compressor head pressure, causing it to trip out. The water supply pressure must be 40 PSI Delta.
Period: approx. every 30 days.
3. Inspect the chamber door gasket. Check to see if the door seals tightly around its perimeter. Replace gasket if significant wear is evident. If the gasket doesn't show any sign of wear, check the operation of the door latch. Adjust the door latch if necessary.
Period: approx. every 30 days.
4. Only after disconnecting all power to the chamber, inspect and clean the conditioner fans / blower wheels, and the condenser fans (air-cooled units). Make sure they spin freely. Make sure that the conditioner fans / blower wheels are tight on their shafts.
Period: approx. every 6 months.
5. Only after disconnecting all power to the chamber, clean the evaporator coil in the chamber conditioning plenum.
Period: approx. every 6 months.

6. Only after disconnecting all power to the chamber, inspect inside the machinery compartment and look for loose electrical connections, frayed wires, loose components, or other potential problems.
Period: approx. every 6 months.
7. Only after disconnecting all power to the chamber, inspect the electric heaters inside the chamber conditioning plenum and look for sagging elements, broken insulators, or other defects.
Period: approx. every 6 months.
8. If your chamber has the optional TempGard IV, do the following:
Period: approx. every 6 months.
 - a) **High Setpoint:** Dial a temperature well below actual workspace temperature. The instrument must transfer to alarm state, disabling protected circuits.
 - b) **Low Setpoint:** Dial a temperature well above actual workspace temperature. The instrument must transfer to alarm state, disabling protected circuits.
 - c) Test the alarm buzzer, making sure it is operable.
 - d) If customer's contact closure is used to energize an externally powered heat source, make sure that the contact closure removes power when TempGard IV is in the alarm state.

Important Note: For **complete** preventative maintenance instructions or equipment maintenance instructions on any of the instruments, electrical or mechanical components, or electrical / mechanical machinery and motors, you must refer to their operating manuals included with your Tenney, or Lunaire Environmental manual. The smaller manuals and vendor cut-sheets are located in the Supplemental Instructions Section. Any large manuals that could not fit into this 3-ring blue binder are sent alongside of it.

Notes:

- ◆ The refrigeration system is permanently sealed and a periodic oil change is NOT required.
- ◆ If a loss of cooling performance is noted, immediately check the condenser for restricted air flow.
- ◆ All motors are permanently lubricated; therefore, greasing or oiling is not required.

21.0 SERVICING CASCADE REFRIGERATION SYSTEMS

INTRODUCTION

Note: Only qualified service personnel should ever be permitted to perform any service related procedure on this chamber!

This information is written to help the refrigeration serviceman trouble-shoot and repair low temperature cascade systems. It is assumed that the reader is familiar with standard refrigeration practice and is interested in the special techniques applicable to cascade systems.

Important! Please remember that the following description may differ in some respects to the refrigeration system equipped with your particular chamber.

History:

Prior to the development of low boiling point refrigerants such as R13 (-114 deg. F) and R503 (-127 deg. F), reaching ultra low temperatures with mechanical refrigeration was difficult. R22 was used down to -80 deg. F, but its system had serious drawbacks. Large and cumbersome, the machinery was subject to the many troubles that afflict a compound system operating at suctions as low as 23 inches of vacuum. The modern cascade system can reach as low as -120 deg. F with suction pressures of 0 PSIG or higher. Compact, serviceable, and reliable, today's cascade system is found on thousands of environmental test chambers.

How It Works:

Two types of popular cascade systems are expansion valve and capillary tube. The system described in this manual is the capillary tube type.

Refrigerants with low boiling points have correspondingly high condensing pressures at normal ambients. They cannot be liquefied by conventional air or water-cooled condensing units. Therefore, low temperature refrigerants are condensed by a separate refrigeration system called "the high stage". The main job of the high stage in most cascade systems is to condense low stage refrigerant.

High Stage:

The high stage is a conventional single-stage system having a compressor, air or water cooled condenser, expansion valve, and evaporator. The evaporator is the cascade condenser, serving the low stage. Modern systems use R404a in the high stage, making -50 deg. F refrigerant temperature possible at 0 PSIG suction pressure.

Low Stage:

The low stage is charged with refrigerant in vapor phase only to a specified gauge pressure. When the low-stage is idle with all components stabilized at 70 deg. F, it will contain no liquid refrigerant. When the system is activated, the low stage compressor will pump hot gas through the discharge line to the de-superheater (on 1HP units only). The de-superheater (air or water-cooled) removes some heat from the refrigerant gas, lightening the heat load on the cascade condenser. Leaving the de-superheater, the gas passes through an oil separator and flows to the cascade condenser. Here it is liquefied by heat exchange with high stage refrigerant and flows to the expansion valve.

Cascade Condenser:

The cascade condenser is the high stage system's evaporator and low stage system's condenser. It can be either tube-in-tube with the low-stage refrigerant in the outside tube, or tube-in-shell with the low-stage refrigerant in the shell.

De - Superheater (only on 1HP units):

The de-superheater consists of coils as part of the high stage condenser with low stage discharge gas running through them. Its purpose is to remove some heat from the low stage discharge gas and thereby lighten the load on the high-stage system.

Evaporator Coil:

The evaporator coil is part of the low stage system in which the liquid refrigerant boils or evaporates, absorbing heat as it changes into a vapor. Refrigerant flow to the evaporator is metered by a capillary tube type valve.

Capillary Tube:

A capillary tube is a length of tubing of small diameter with the internal diameter held to extremely close tolerances. It is used as a fixed orifice to meter the proper feed of liquid refrigerant.

Thermostat:

A thermostat TS is mounted on the suction return line near the low stage compressor to monitor the temperature of the return gas flow. When a predetermined high temperature is reached, the thermostat will energize the Artificial Loading solenoid 14SOL. The setting is normally 70 degrees Fahrenheit.

Load Limit Switch:

A high pressure cut-in sensor monitors the pressure inside the low stage compressor and will activate the Load Limit Switch 4PS when the low stage discharge pressure reaches 280 PSIG. This will energize the Artificial Loading solenoid 14SOL. 4PS will be deactivated when the pressure falls to 240 PSIG.

Artificial Loading:

In response to the Thermostat switch TS or the Load Limit switch 4PS, the Artificial Loading solenoid will inject liquid refrigerant into the suction side of the low stage. It will first enter the expansion tank where the added volume permits the charging of additional refrigerant without increasing the standby or charging pressure beyond workable limits. Refrigerant gas is then sucked out of the expansion tank and metered through a capillary tube to the suction side of the low stage compressor. This action will maintain a positive cool refrigerant flow to the compressor, preventing overheating of the compressor and the discharge gas.

Expansion Tank:

An expansion tank is provided to add volume to the low stage. Added volume permits the charging of additional refrigerant without increasing the standby or charging pressure beyond workable limits. Refrigerant gas is sucked out of the expansion tank during system operation. It is metered through a capillary tube, regulating the rate of gas entry into the system.

Frosted Lines Are Typical:

A low-stage characteristic is frosted liquid and suction lines. In a normal cascade system, the liquid line is always below +32 deg. F. The suction line, returning from a -100 deg. F evaporator, assuming 15 degree superheat, will also be far below freezing.

Leak Testing:

Loss of refrigerant is the most common cause of refrigeration failure. Because of temperature extremes experienced by its metal parts, the cascade system is particularly susceptible to leaks.

Check the entire system with an electronic leak detector. If the system is empty or at low pressure, boost pressure to 200 PSIG with inert gas (not oxygen) diluted with a percentage of high stage refrigerant. Test again.

A leak check while the system is at low temperature, -80 deg. F or colder, is a necessity. Expansion valve flanges, superheat adjustment caps, and other mechanical joints should be tightened and checked for leaks while at low temperature.

You may use a Halide torch to locate large leaks, but make your final test with the more sensitive electronic leak detector. This is especially important on the low stage. The low stage is gas charged with a relatively small quantity of refrigerant. Because of this, small leaks can quickly incapacitate the system.

Testing by Static Charge:

One advantage of a gas charged system is that its tightness can be checked by periodic observation of static or standby pressure. You must read the pressure with all parts of the system at ambient temperature. This is important. The unit must be shut down at least 24 hours before a static pressure reading is taken. To eliminate the possibility of cooling the cascade condenser with the high-stage, pump-down cycle, all power to the unit must be off during the shut down period.

When reading static pressure, consider ambient temperature. Most static charge data are for a 10 deg. F decrease in temperature. Due to a large system's considerable thermal mass, several days may be required for all components to completely stabilize at a particular ambient.

Evacuation:

Granted, refrigerants R23 and R404a are expensive, but there are times when charges must be recovered. A contaminated system must be cleaned and evacuated regardless of refrigerant expense.

If there is a possibility that moisture, non-condensibles, or the wrong refrigerant contaminated a system, recover the charge and evacuate.

Select a two-stage pump capable of pumping the system down below 200 microns, and connect an appropriate gauge to ready system pressure. The ordinary compound refrigeration gauge is inadequate, however a thermocouple gauge is ideal. Evacuating a leaky system is an exercise in futility. Therefore, make sure the system is absolutely tight before beginning evacuation.

Charging a Low Stage:

1. Do not charge liquid into the low stage.
2. Do not charge the system when it is below room temperature.
3. Do not use charging hoses on very high pressure refrigerants or low stage refrigerants. Cylinder pressure exceeds 500 PSIG.
4. Never charge the unit when it is running.

As you will note from the above, low stage charging procedure differs from the conventional method. Correct charging pressure will be noted on the equipment nameplate or in the instructions. Remember that it is important that you charge by pressure, not by volume of refrigerant.

Use 1/4 inch copper tube between refrigerant cylinder and system. Open the cylinder valve very slowly. Charge into the suction side while closely watching the discharge gauge. When correct pressure is reached, shut off the refrigerant cylinder valve, allowing the system to equalize from 10 to 15 minutes. If the pressure drops, crack open the cylinder valve, and slowly raise the pressure. Always take enough time. Systems with expansion tanks connected by a capillary tube or restrictor valve may need several minutes for gas pressure to equalize.

Keep the refrigerant cylinder upright when charging. Above all, be careful. Do not over-pressurize. Disconnect the cylinder immediately when charging is complete. A leaky cylinder valve could continue to bleed high pressure refrigerant into the system, possibly causing it to rupture. Do not take chances. The saturation pressures of low temperature refrigerants are extremely high.

22.0 CHAMBER TROUBLESHOOTING GUIDE

This section does not propose to be a complete and comprehensive troubleshooting guide for the serviceman. However, it attempts to help you locate the causes of possible troubles so that you can make simple repairs or adjustments yourself. The information here should also help you in localizing trouble so that you can better describe the malfunction when contacting the Tenney Service Department. Refer to the appropriate electrical and refrigeration drawings when using these troubleshooting suggestions.

TENNEY JUNIOR TROUBLESHOOTING GUIDE		
PROBLEM	POSSIBLE CAUSE	CORRECTIVE ACTION
1. Conditioner fan dead	Motor shaft frozen	Verify - rotate by hand carefully!
	Defective motor	Verify - feel for heat & measure current
2. Insufficient Heat	Chamber door is ajar	Close securely
	One heater element is burned out	Verify - measure current
	Controller failure	Carefully check programming
3. No Heat	Heat Limiter opened	Replace
	Heater elements burned out, or open	Replace
	Heat output failing to close	Verify - Contact Tenney Service
	Triac 1TRC failed open	Replace
	Open temperature sensor	Replace
4. Excessive Heat	Triac 1TRC failed in conducting state (usual failure mode)	Replace
	Heat output failing to open	Verify - Contact Tenney Service
	Short circuited temperature sensor	Replace
5. Refrigeration System Dead	Cooling output failing to close	Verify - Contact Tenney Service
	Triac 2TRC failing to conduct	Replace
	Compressor motor overload protector has tripped	Wait for 5 minutes. If overload does not close - replace it
6. Compressor hums but will not start	Low line voltage	Get proper electrical service
	Starting capacitor is defective	Replace
	Compressor relay defective	Replace
	Internal compressor problem	Measure winding resistance, test for grounds, contact Tenney Service
7. Repeated shorting or blowing of start capacitors	Excessive start time, voltage too low	Correct low line voltage problem

TENNEY JUNIOR TROUBLESHOOTING GUIDE - continued		
PROBLEM	POSSIBLE CAUSE	CORRECTIVE ACTION
8. Compressor starts, hums, runs slowly, staying on start winding	Low line voltage	Get proper electrical service
	Compressor relay is stuck	Replace
	Shorted winding	Test resistances, test for grounds, contact Tenney Service
9. Low stage compressor will not run	Pressure switch PS2 not closing	Contact Tenney Service
10. Low stage runs, but little or no cooling	Low stage is low on refrigerant	Have system leak tested
	Artificial loading valve SV stuck open full time	Replace
	Main cooling coil badly frosted	Raise temperature to defrost
11. Compressor runs but cools inefficiently	Restricted ventilation, dirty condenser fins	Move unit away from wall, clean condenser fins
12. Refrigeration works long or continuously	Excessive heat load	Reduce load if possible
	Ice on evaporator coil	Defrost
	Low refrigerant charge	Have charge checked by refrigeration mechanic - charges are on ID label
13. Compressor repeatedly trips out overload protector	Pressure switch failure	Have refrigeration mechanic check switches. Contact Tenney Service
14. Noisy compressors	Compressor loose on mounts	Tighten hold down nuts
15. Noisy compressors, even with secure hold-downs	Broken springs within compressor housing	Replace compressor - Call Tenney for assistance

NOTE: At site ambient temperature, if the chamber does not pull down substantially in temperature within 15 minutes, something is wrong. Turn the chamber off. Let it normalize and defrost. Then, try it again. If it still does not pull down to low temperature, shut it off and get technical help. A refrigeration system which does not cool properly should not be run for prolonged periods. It may have a leak and be low on refrigerant. Since the compressor depends upon cool returning refrigerant for cooling, it can be overheated when operated in an undercharged system.

Remember that the compressors have internal overloads with automatic reset; these are in addition to circuit breakers. Therefore, when a compressor cuts out, it must be given time to cool so that its internal protector has time to reset.

SUPPLEMENTAL INSTRUCTIONS