



Advanced Test Equipment Corp.
www.atecorp.com 800-404-ATEC (2832)

Model 2900 System Manual



Thunder Scientific Corporation

Model 2900 Humidity Generation System

Document #OM2900 - Edition 1.9

OPERATION AND
MAINTENANCE MANUAL



Model 2900 Humidity Generation System

1 TABLE OF CONTENTS

2	Getting Started	6
2.1	About.....	6
2.2	Notice.....	7
2.3	Safety Information.....	7
2.3.1	Live Power Source.....	7
2.3.2	Electrostatic Discharge.....	7
2.3.3	Compressed Gas.....	7
2.3.4	Personal Protective Equipment.....	7
2.3.5	Safety Symbols.....	7
2.4	Technical Support.....	8
2.5	License Agreement.....	8
2.6	Warranty.....	10
2.7	Copyright.....	10
2.8	Trademarks.....	10
2.9	Specifications.....	11
2.10	Uncertainty.....	12
2.11	Facility Requirements.....	13
2.11.1	Environment.....	13
2.11.2	Floor Space.....	13
2.11.3	Power.....	13
2.11.4	Air Supply.....	13
2.11.5	Distilled Water Supply.....	13
2.12	Installation.....	14
2.12.1	Uncrating.....	14
2.12.2	Positioning.....	14
2.12.3	Chamber Fluid.....	14
2.12.4	Reservoir Initial Filling Procedure.....	15
2.12.5	Setting Supply Pressure Regulator.....	15
2.13	Quick Start.....	16
2.13.1	Power-Up.....	16
2.13.2	Loading Screen.....	17
2.13.3	ControLog Screen.....	18
2.13.4	Control Parameters.....	19
2.13.5	Control Modes.....	21
2.13.6	Generating and Shutting down.....	22
2.13.7	Power-Off.....	23
2.13.8	Set Date and Time.....	24
2.13.9	Help.....	25
3	Principle of Operation	26
3.1	Pre-Saturation ($T_{P_{sat}}$).....	26
3.2	Expansion Valve (T_{ExV}).....	26
3.3	Saturation Temperature (T_s).....	27
3.4	Chamber Temperature (T_c).....	27
3.5	Saturation Pressure (P_s).....	27
3.6	Chamber Pressure (P_c).....	27
3.7	Humidity Formulas.....	27
4	ControLog Interface	28

4.1	Menu Bar.....	29
4.1.1	File Menu Tab.....	29
4.1.2	Home Menu Tab.....	33
4.1.3	Units Menu Tab.....	36
4.1.4	Operation Menu Tab.....	37
4.1.5	Profile Menu Tab.....	40
4.1.6	Utilities Menu Tab.....	42
4.1.7	Graph Menu Tab.....	46
4.1.8	Data Menu Tab.....	48
4.1.9	Device Settings Menu Tab.....	52
4.1.10	Help.....	54
4.2	Parameters Tab Group.....	55
4.2.1	Tiles.....	57
4.2.2	2900 Parameter Tab.....	61
4.2.3	Device Parameter Tabs.....	66
4.3	Data and Graph Tab Group.....	67
4.3.1	Data Tabs.....	68
4.3.2	Graph Tabs.....	68
4.3.3	Profile Tab.....	68
4.4	Information Tab Group.....	69
4.4.1	Status Log.....	71
4.4.2	2900 Reported Errors.....	71
4.4.3	System timing.....	71
4.4.4	2900 Interface Console.....	71
4.4.5	Device Interface Console.....	72
4.5	Status Bar.....	73
4.5.1	Connection and Run Status.....	73
4.5.2	Auto Profile Controls and Status.....	74
4.5.3	Current Point Time.....	75
4.5.4	Set Date and Time.....	75
5	Fluid Levels	77
5.1	Water Reservoir Level.....	77
5.1.1	Fill Water Reservoir.....	78
5.2	Liquid Level Sensors.....	79
5.2.1	Pre-Saturator Level.....	79
5.2.2	Flow Switch.....	80
6	Calibration	81
6.1	Temperature Calibration.....	81
6.1.1	Equipment Required.....	82
6.1.2	Calibration Procedure.....	82
6.2	Pressure Transducer Calibration.....	102
6.2.1	Equipment Required.....	102
6.2.2	Calibration Procedure.....	102
6.2.3	Supply Pressure.....	120
6.3	Mass Flow Meter Calibration.....	121
6.3.1	Equipment Required.....	121
6.3.2	Calibration Procedure.....	121
6.4	Viewing and Editing Calibration Coefficients.....	138
7	Graphing	143
7.1	Creating a New Graph.....	144
7.1.1	Line Properties.....	146

	7.1.2	Chart Properties.....	147
7.2		Customizing a Graph.....	148
	7.2.1	Pan.....	148
	7.2.2	Zoom.....	149
	7.2.3	Zoom Graph's X Axis.....	150
	7.2.4	Zoom Graph's Y Axis.....	151
	7.2.5	Auto Scale.....	151
	7.2.6	Scale.....	151
	7.2.7	Scale X Axis.....	151
	7.2.8	Scale Y Axis.....	151
	7.2.9	Graph Properties.....	152
7.3		Saving a Graph.....	155
8		Data and Data Summary	157
8.1		Device Data Tabs.....	161
8.2		File Data Tabs.....	162
8.3		Data Summary Tabs.....	165
	8.3.1	Creating a Data Summary.....	166
8.4		Recorded Data Points Tab.....	173
	8.4.1	How to Record a Data Point.....	174
9		Auto Profiling	179
9.1		Creating a New Profile.....	181
9.2		Saving a Profile.....	193
9.3		Opening a Profile.....	195
9.4		Running an Auto Profile.....	197
	9.4.1	Understanding Profile Phases.....	199
	9.4.2	Manual Override of Profile.....	202
10		Connections	205
10.1		Serial Connection.....	206
	10.1.1	Serial Connection Example 1.....	221
	10.1.2	Serial Connection Example 2.....	233
10.2		Analog Connection.....	250
	10.2.1	Analog Connection Example.....	260
10.3		Manual Connection.....	269
	10.3.1	Manual Connection Example.....	273
10.4		Opening a Device Connection.....	281
11		Data Backup	282
12		System	283
12.1		Control System.....	283
	12.1.1	Control Computer.....	283
	12.1.2	HMI Computer.....	284
	12.1.3	ControlLog® Software.....	284
	12.1.4	HumiCalc with Uncertainty® Software.....	285
12.2		Electrical System.....	285
	12.2.1	Solid State Relays.....	286
12.3		Pneumatic System.....	287
	12.3.1	Pressure Measurement.....	287
	12.3.2	Mass Flow Rate Measurement.....	287
	12.3.3	Pre-Saturator.....	288

12.3.4	Reservoir	288
12.3.5	Saturator	288
12.3.6	Flow Control Valve	288
12.3.7	Expansion Valve	289
12.3.8	Chamber Pressure	289
12.3.9	Test Chamber	289
12.4	Fluid System	289
12.4.1	Liquid Level Measurement	289
12.4.2	Fluid Flow Measurement	289
12.4.3	Temperature Controlled Chamber Fluid	290
12.4.4	Chamber Fluid Heating	290
12.4.5	Chamber Fluid Refrigeration	290
12.4.6	Temperature Measurement	290
12.4.7	Fluid Jacket Door Option	290

13 Maintenance 291

13.1	Drain Pre-Saturator	291
13.2	Chamber Fluid	291
13.3	Air Input Filters (Mobile Cart)	291
13.4	Circulation Pump Motor	292
13.5	Pre-Saturator Liquid Level Checkout	292
13.6	Reservoir Liquid Level Checkout	292
13.7	Warning and Error Messages	293
13.7.1	Saturation Temperature at Minimum Limit	293
13.7.2	Saturation Temperature Over Range or at Maximum Limit	293
13.7.3	Pre-Saturation Temperature at Minimum Limit	293
13.7.4	Pre-Saturation Temperature Over Range or at Maximum Limit	293
13.7.5	Expansion Valve Temperature at Minimum Limit	293
13.7.6	Expansion Valve Temperature Over Range or at Maximum Limit	294
13.7.7	Chamber Temperature at Minimum Limit	294
13.7.8	Chamber Temperature Over Range or at Maximum Limit	294
13.7.9	Cabinet Temperature Over Range or at Minimum/Maximum Limit - Check Cabinet Fans	294
13.7.10	Insufficient Supply Pressure to Generate	294
13.7.11	Supply Pressure Over Range or at Maximum Limit	294
13.7.12	Saturation Pressure at Minimum Limit	294
13.7.13	Saturation Pressure Over Range or at Maximum Limit	294
13.7.14	Saturation Pressure Transducer Not Responding	295
13.7.15	Chamber Pressure at Minimum Limit	295
13.7.16	Chamber Pressure Over Range or at Maximum Limit	295
13.7.17	Chamber Pressure Transducer Not Responding	295
13.7.18	Mass Flow Rate at Minimum Limit	295
13.7.19	Mass Flow Rate Over Range or at Maximum Limit	295
13.7.20	Refrigeration Compressor Low Side Pressure at Minimum Limit	295
13.7.21	Refrigeration Compressor Low Side Pressure Over Range or at Maximum Limit	295
13.7.22	Refrigeration Compressor High Side Pressure at Minimum Limit	296
13.7.23	Refrigeration Compressor High Side Pressure Over Range or at Maximum Limit	296
13.7.24	Flow Valve Reported Error:	296
13.7.25	Flow Valve Failed to Find Home Position	296
13.7.26	Flow Valve at Minimum Limit	296
13.7.27	Flow Valve at Maximum Limit	296
13.7.28	Expansion Valve Reported Error:	296
13.7.29	Expansion Valve Failed to Find Home Position	296

13.7.30	Expansion Valve at Minimum Limit - Check for air leaks	296
13.7.31	Expansion Valve at Maximum Limit - Reduce Mass Flow Rate	296
13.7.32	Distilled Water Reservoir is Empty.....	297
13.7.33	Distilled Water Reservoir is Low.....	297
13.7.34	Unable to Fill Pre-Saturator	297
13.7.35	No Fluid Flow	297
13.7.36	No Saturation Fluid Heat.....	297
13.7.37	No Pre-Saturator Heat	297
13.7.38	No Expansion Valve Heat.....	297
13.7.39	System Failed to Vent Pressure on Shutdown.....	297
13.7.40	Mass Flow Rate is being limited to achieve Humidity setpoint.	298
13.7.41	Insufficient Supply Pressure to reach setpoint	298

14 Drawings and Diagrams 299

14.1	18D29901-1 - Part List.....	300
14.2	18D29901-2 – 2900 Components.....	301
14.3	18D29901-3 – 2900 Components (Back).....	302
14.4	18D29901-4 – 2900 Components (Top).....	303
14.5	18D29901-5 – Pneumatic Schematic.....	304
14.6	18D29901-6 – Fluid Schematic.....	305
14.7	18D29901-7 – Refrigeration Schematic	306
14.8	18D29901-8 – Pneumatic Components.....	307
14.9	18D29901-9 – Refrigeration Components.....	308
14.10	18D29901-10 – Electrical Components.....	309
14.11	18D29901-11 – Data Acq. Components.....	310
14.12	18D29908 – Chamber Fan Components.....	311
14.13	18D29909-1 – Chamber Fluid Filling Instructions.....	312
14.14	18D29909-2 – Chamber Fluid Draining Instructions	313
14.15	18D29910-1 – Cart / ACS Assembly	314
14.16	18D29910-2 – Filter / Regulator Assembly.....	315
14.17	18D29910-3 – Cart Pneumatic System Schematic	316
14.18	18S29911 – AC / DC Power Distribution	317
14.19	18S29912 – Temperature Probe Schematic.....	318
14.20	18S29913 – Pre Tran/Stepper Drive Schematic	319
14.21	18S29914 – Transducer Schematic	320
14.22	18S29915 – Pump / Comp / Flow Schematic	321
14.23	18S29916 – Exp. valve / Fluid Heater Schematic	322
14.24	18S29917 – Pre Saturator Heater Schematic.....	323
14.25	18S29918 – Solenoid Valve Control Schematic.....	324
14.26	18S29919 – Fan Control Schematic	325

2 GETTING STARTED

This section will provide the user with information about the Model 2900 humidity generator, where to obtain technical support, software license agreement, specifications, uncertainty, facility requirements and installation. Following sections will provide further details on how to use and operate the Model 2900 generator using the ControLog software.

Note - *All pressures are absolute unless noted otherwise.*

2.1 ABOUT

The Thunder Scientific Model 2900 Humidity Generator is capable of producing known humidity values using the fundamental, NIST proven, "two-pressure" principle. The Model 2900 uses this fundamental "two-pressure" principle to continuously supply a known relative humidity, dew point, frost point, parts per million, or other calculated value for instrument calibration and evaluation as well as precision environmental testing.

The Model 2900 humidity generator encompasses a high-performance stand-alone Data Acquisition Computer that performs all functions required for humidity generation and control and a second dedicated Human Machine Interface (HMI) computer that runs ControLog. ControLog is a software application that fully automates the operation of the Model 2900 humidity generator and allows various device connections through a number of different interfaces. Data from the generator and connected device or devices is automatically retrieved and stored for viewing in either numerical or graphical format in real time or post process. Data can be transferred off the system via a USB drive for further viewing, post processing and printing. The ControLog software also provides the primary interface to the operator via the multi-point touch LCD and keyboard.

Key features of the of the ControLog software are:

- ControLog stores data into individual data sheets (tab). Each data sheet contains a spreadsheet type view that consists of a date/time stamp and the measured data items corresponding to that date/time stamp. Data sheets consist of three similar but different types: Device Data, File Data and Data Summary. Each type has the same spreadsheet type view and operation, but all three have different data sources.
- Graphing is a powerful tool used to view previously recorded data or to monitor the current data in real-time. The graph works hand in hand with the data sheets. While the generator is in operation, data sheets store the most recent data points from the generator and or connected devices at the desired interval. A graph can be used to create a visual picture of this stored data.
- The Auto Profiling feature is very similar to the Generate mode with the main exception that profiling relies on a predefined list of setpoints referred to as a profile. The user configurable profile is used as ControLog's road map during Auto Profile operation. It defines which setpoint values to go to, at what rate to go from one setpoint to another, and how long to stay at a specific setpoint before moving to the next setpoint.
- ControLog supports a customizable interface that works with most devices. ControLog will allow the user to create a new device connection using the "Connection Wizard" or open previously saved connections. The wizard will open a separate dialog window containing various steps that will guide the user in defining the communication required to receive the desired data items from

the device. The user can create as many (up to 60) or as few data items as they see fit for any one device. Each data item can be uniquely named and once connected will be recorded in its own data sheet. ControLog also allows the user to save these interfaces for future use. The "Connection Wizard" allows the user to step through the connection configuration. Using the "Next" and "Back" buttons the user is allowed to progress through the connection configuration steps. At any time, the user may cancel the new connection or opening of a connection by selecting the "Cancel" button. Once the last step has been completed the "Finish" button will be available to complete the new connection.

2.2 NOTICE

The specifications listed and the information contained in this document is subject to change without notice. Screen shots shown in this document may differ slightly from the actual product and are given to show functionality of the examples, procedures and program. Thunder Scientific Corporation makes no warranties, either express or implied, regarding the examples, procedures and program, or the fitness of these examples, procedures or program for a particular purpose. The examples, procedures and program are made available solely on an "as is" basis and the entire risk as to their quality and performance rests with the user. Thunder Scientific Corporation shall not be liable for any incidental or consequential damages in connection with or arising out of the furnishing, use, or performance of the examples, procedures or program.

2.3 SAFETY INFORMATION

Important safety guidelines need to be observed when operating this equipment. Precautions are highly advisable so that no personal injury will occur during the operation and maintenance of the system. Observation of local and national regulations must be adhered to regarding safety standards.

2.3.1 Live Power Source

Warning! Make sure all power sources are turned off before making internal adjustments or replacing any components. Only authorized technicians should perform any maintenance or repairs to equipment.

2.3.2 Electrostatic Discharge

Caution! Electrostatic discharge (ESD) could possibly damage or destroy solid-stat parts when exposed to static electric discharges. Be aware because electrostatic discharges may not be seen, felt or heard at levels less than 4,000 volts.

2.3.3 Compressed Gas

Compressed gas is used on this system and if not properly vented may create an environment where the state of foreign matter may be propelled. Proper safety precautions must be followed when applying any pressure to the system. Before applying any pressure to the system, ensure that all pneumatic connections are properly secured and tightened. Make sure all pressure settings are set to the proper specifications before operation, testing, calibration or maintenance is performed.

2.3.4 Personal Protective Equipment

Safety glasses must be worn when performing any maintenance, repairs or calibration when system panels have been removed. Gloves may be needed on some maintenance or repairs.

2.3.5 Safety Symbols

Symbols used in this manual for safety and other disciplines can be found in table 1-1.

Safety terminology used for identification of any safety conditions are as follows:

Warning indicates a potential hazard may exist and the user should be extremely careful.

Caution! identifies a condition or action that may cause damage to the system or the user.





Symbol	Description
	The equipment has this symbol displayed and indicates that the equipment meets the requirements of the European safety directives.
	This symbol is shown from the WEEE directive and indicates do not dispose of this product in any municipal waste area.
	This symbol means Caution should be observed or important information.
	This symbol indicates a potential shock hazard may exist.
	This symbol means Earth Ground.

Table 1-1

2.4 TECHNICAL SUPPORT

If the user requires assistance with any aspect of the 2900 Humidity Generating System or the ControLog application, technical support can be obtained by contacting Thunder Scientific Corporation by any of the following means:

Web: www.ThunderScientific.com

Email: support@thunderscientific.com

Tel : 1-505-265-8701

FAX : 1-505-266-6203

2.5 LICENSE AGREEMENT

THIS IS A LEGAL AGREEMENT BETWEEN YOU, THE END USER, AND THUNDER SCIENTIFIC CORPORATION ("TSC"). THE ENCLOSED THUNDER SCIENTIFIC CORPORATION SOFTWARE PROGRAM (THE "SOFTWARE ") IS LICENSED BY THUNDER SCIENTIFIC CORPORATION TO THE ORIGINAL CUSTOMER AND ANY SUBSEQUENT TRANSFEREE OF THE PRODUCT FOR USE ONLY ON THE TERMS SET FORTH HERE. PLEASE READ THIS LICENSE AGREEMENT. IF YOU DO NOT AGREE TO THESE TERMS, RETURN THE FULL PRODUCT WITH PROOF OF PURCHASE WITHIN 30 DAYS FOR A FULL REFUND.

- GRANT OF LICENSE. TSC grants to you the right to use one copy of the enclosed SOFTWARE on a single terminal connected to a single computer (i.e. single CPU) or to a network server. If you install the SOFTWARE on a network server, you must purchase a separate copy of the SOFTWARE for each computer terminal that will be used to operate the SOFTWARE. If the anticipated number of users of the SOFTWARE will exceed the number of applicable Licenses,

then you must have a reasonable mechanism in place to ensure that the number of persons using the SOFTWARE concurrently does not exceed the number of Licenses. If the SOFTWARE is permanently installed on the hard disk or other storage device of a computer (other than a network server) and one person uses that computer more than 80% of the time, then that person may also use the SOFTWARE on a portable or home computer.

- **COPYRIGHT.** The SOFTWARE is owned by TSC and is protected by United States copyright laws and international treaty provisions. You may either (a) make two copies of the SOFTWARE solely for backup or archival purposes provided that you reproduce all copyright and other proprietary notices that are on the original copy of the SOFTWARE provided to you, or (b) transfer the SOFTWARE to a single hard disk provided you keep the original solely for backup or archival purpose. You may not copy the written materials accompanying the SOFTWARE.
- **OTHER RESTRICTIONS.** You may not rent or lease the SOFTWARE, but you may transfer the SOFTWARE and accompanying written materials on a permanent basis provided you retain no copies and the recipient agrees to the terms of this Agreement. You may not reverse engineer, decompile, disassemble, or create derivative works from the SOFTWARE.

SOFTWARE and written materials

- **GOVERNMENT LICENSEE.** If you are acquiring the SOFTWARE on behalf of any unit or agency of the United States Government, the following provisions apply:

The Government acknowledges TSC's representation that the SOFTWARE and its documentation were developed at private expense and no part of them is in the public domain.

The Government acknowledges TSC's representation that the SOFTWARE is "Restricted Computer Software" as that term is defined in Clause 52.227-19 of the Federal Acquisition Regulations (FAR) and is "Commercial Computer Software" as that term is defined in Subpart 227.471 of the Department of Defense Federal Acquisition Regulations Supplement (DFARS).

The Government agrees that:

- (i) If the SOFTWARE is supplied to the Department of Defense (DoD), the SOFTWARE is classified as "Commercial Computer Software" and the Government is acquiring only "restricted rights" in the SOFTWARE and its documentation as that term is defined in Clause 252.227-7013(c) (1) of the DFARS, and
 - (ii) If the SOFTWARE is supplied to any unit or agency of the United States Government other than DoD, the Government's rights in the SOFTWARE and its documentation will be as defined in Clause 52.227-19 (c) (2) of the FAR.
- **RESTRICTED RIGHTS LEGEND.** Use, duplication, or disclosure by the Government is subject to restrictions as set forth in subparagraph (c) (1) (ii) of the Rights in Technical Data and Computer Software clause at DFARS 252.227-7013. Thunder Scientific Corporation, 623 Wyoming SE, Albuquerque, NM 87123.
 - **EXPORT LAW ASSURANCES.** You acknowledge and agree that the SOFTWARE is subject to restrictions and controls imposed by the United States Export Administration Act (the "Act") and the regulations thereunder. You agree and certify that neither the SOFTWARE nor any direct product thereof is being or will be acquired, shipped, transferred or re-exported, directly or indirectly, into any country prohibited by the Act and the regulations thereunder or will be used for any purpose prohibited by the same.
 - **GENERAL.** This Agreement will be governed by the laws of the State of New Mexico, except for that body of law dealing with conflicts of law.

Should you have any questions concerning this Agreement, or if you desire to contact TSC for any reason, please write: Thunder Scientific Corporation, 623 Wyoming NE, Albuquerque, NM 87123

2.6 WARRANTY

Thunder Scientific Corporation (TSC) warrants, to the Buyer, the Product manufactured by TSC to be free of defects in material and workmanship under normal use and service and to be free from inadequate mechanical design when operated within the specified design limitations for a period of one year from date of acceptance. TSC's obligation under this warranty shall be limited to the following: The Product is returned to TSC with transportation charges prepaid and that TSC's examination reveals the Product to be defective. TSC, at its option, shall either refund to the Buyer the purchase price of the product or repair or replace at TSC's plant, any part or parts of the Product which is or are defective. This warranty shall not apply to any Product which has been maintained, handled, stored, repaired or altered in any manner, or by anyone other than an authorized TSC representative, so as to affect adversely such Product or which has been subject to improper installation, misuse, negligence, accident or corrosion. THIS WARRANTY IS EXCLUSIVE AND IN LIEU OF ANY WARRANTY OF MERCHANTABILITY, FITNESS FOR A PARTICULAR PURPOSE OR ANY OTHER WARRANTY, WHETHER EXPRESS OR IMPLIED, AND ALL OTHER LIABILITIES AND OBLIGATIONS ON THE PART OF TSC; TSC SHALL NOT BE LIABLE FOR ANY OTHER CLAIMS OR DAMAGES, EITHER DIRECT OR CONSEQUENTIAL, ARISING DIRECTLY OR INDIRECTLY OUT OF SUPPLYING THE PRODUCT. All warranties, express or implied, with respect to any device or component not manufactured by TSC but incorporated into its Product are the responsibility of the original manufacturer and shall not affect or apply to TSC.

2.7 COPYRIGHT

©2009-2020 Thunder Scientific Corporation

623 Wyoming Blvd. SE

Albuquerque, New Mexico 87123, USA

This document contains proprietary information which is protected by copyright. All rights are reserved. No part of this document may be reproduced or transmitted in any form or by any means, electronic or mechanical, including photocopying and recording, for any purpose without the prior written consent of Thunder Scientific Corporation.

2.8 TRADEMARKS

® *ControLog* is a trademark of Thunder Scientific Corporation.

® *HumiCalc* is a trademark of Thunder Scientific Corporation.

® THUNDER SCIENTIFIC is the registered trademark of Thunder Scientific Corporation

MADE IN USA



2.9 SPECIFICATIONS

Relative Humidity Range:	10 to 95 %RH, 10 to 40 L/min
Relative Humidity Range: ¹	95 to 98 %RH, 10 to 20 L/min
Frost Point Temperature Range:	-33.60 to 0 °C
Dew Point Temperature Range:	-36.94 to 70 °C
Chamber Temperature Range: ²	-10 to 72 °C
Chamber Temperature Control Stability: ³	0.002 °C
Chamber Temperature Uniformity: ⁴	<0.04 °C
Chamber Temperature Heating Rate: from -10 to 72 °C	0.5 °C per Minute (average)
Chamber Temperature Cooling Rate: from 72 to 0 °C	0.5 °C per Minute (average)
Chamber Temperature Cooling Rate: from 0 to -10 °C	0.2 °C per Minute (average)
Temperature Specification:	0.027 °C
Gas Type:	Air or Nitrogen
Gas Pressure Rating: (MAWP)	175 psiG
Gas Flow Rate Range:	10 to 50 L/min
Gas Flow Rate Specification:	5% of full scale
Saturation Pressure Range:	Ambient to 160 psiA
Saturation Pressure Specification:	0.02% of full scale
Test Chamber Pressure Range:	Ambient
Test Chamber Pressure Specification:	0.02% of reading
Supply Pressure Range:	Ambient to 150 psiG
Supply Pressure Specification:	±1 psiG
Display Resolution:	0.001
Test Chamber Dimensions:	12" x 12" x 10" (304.8 mm x 304.8 mm x 254 mm)
Physical Dimensions:	22" H x 36" W x 23" D (558.8 mm x 432 mm x 584.2 mm)

¹ The system will limit mass flow rate to 20 L/min for %RH greater than 95.

² Using glycol/water as the temperature heat transfer fluid from -10 to 72 °C. Note: the 2900 can only operate for a finite amount of time at or below 0 °C

³ Temperature Control Stability is defined as the standard deviation over a 10-minute period, as measured by the saturation temperature control sensor after being at point for 60 minutes.

⁴ Chamber Temperature Uniformity is defined as the maximum temperature difference between any two locations at a single point in time. Locations are within one inch of the chamber wall and within 2.5 inches of the chamber door. Using a minimum chamber fan speed of 25% for a temperature range of -10 °C to 72 ° when using fluid jacket door option and ±10 °C from ambient when not.

2.10 UNCERTAINTY⁵

RH Uncertainty: 10 to 95 %RH, 0 to 70 °C, 10 to 40 L/min	0.5% of reading
RH Uncertainty: 95 to 98 %RH, 0 to 70 °C, 10 to 20 L/min	0.5% of reading
Dew/Frost Point Uncertainty: < 0.01 °C, 10 to 40 L/min	0.05 °C
Dew Point Uncertainty: 0.01 to 70 °C, 10 to 40 L/min.....	0.08 °C
Temperature Uncertainty: -10 to 72 °C	0.031 °C

⁵ Chamber pressure at 1 atmosphere, Uncertainty values represent an expanded uncertainty using a coverage factor, $k=2$, at an approximate level of confidence of 95%. Uncertainty is not specified at saturation temperatures below 0 °C or at flow rates below 10 L/min. Uncertainty is based on the worst-case value from the 2900 uncertainty analysis.

2.11 FACILITY REQUIREMENTS

2.11.1 Environment

Operating Temperature: 15 to 30 °C

Storage Temperature: 0 to 50 °C

Humidity: 5 to 95% RH Non-condensing

2.11.2 Floor Space

A bench and/or floor, capable of supporting approximately 300 pounds, with a minimum space of 27" (0.686m) deep x 43" (1.09m) wide.

Allow an additional 20" (0.508m) in width for clearance, if possible, to allow complete opening of the chamber door and access to the test ports.

Refer to drawings: [18D29901-2](#), [18D29910-1](#)

2.11.3 Power

Electrical Power: 200-230/210-240 V~, 10 A, 1 Ø, 50/60 Hz

Gas Supply Maximum Inlet Pressure: 175 psiG @ 50 L/min

2.11.4 Air Supply

When not using the pneumatic cart, a clean, oil free instrument air supply operating at a @ 165 psiG and 50 L/m is required. The air supply should be filtered to a particle size of 0.5 microns or less, a hydrocarbon content of 1 PPM or less, with a pressure dewpoint of 15 °C or less. Regulated supply pressure other than recommended (175 psiG maximum) is acceptable but may limit the lowest humidity obtainable from the generator and will require an internal pressure regulator (REG) adjustment.

Refer to section [2.12.5 Setting Supply Pressure Regulator](#) for more information on adjusting the internal pressure regulator (REG).

2.11.5 Distilled Water Supply

One gallon (3.8 liters) of double distilled water per fill. The one-gallon supply can last from 8 hours to more than 500 hours of use depending upon the temperature and humidity at which the generator is operated (reference section [13.3.4](#)). During operation near ambient temperature and 50% RH, one gallon should last for approximately 200 hours.

2.12 INSTALLATION

2.12.1 Uncrating

Before uncrating, carefully inspect the crate and skid to be certain the unit was not subjected to damage. If there is damage, proceed no further and notify your inspection department and the shipping agent.

If the crate appears satisfactory:

1. Remove steel strapping.
2. Using "Clip Removal Tool" or thin pry-bar, remove top cover clips then remove top panel.
3. One panel at a time, remove the panel clips then remove panel.
4. Remove polyethylene covering from unit.
5. Inspect for any visible damage.
6. Remove any/all accessory boxes.
7. Using forklift or another suitable lifting device, lift unit from skid and place on the 2900 cart or instrument bench.

CAUTION!

BEFORE APPROACHING THE EQUIPMENT WITH THE FORKLIFT, VISUALLY LOCATE ANY HARDWARE WHICH MIGHT PROJECT INTO THE PATH OF THE FORKS. PLACE FORKS AS WIDE AS POSSIBLE TO AVOID DAMAGE TO THE FRAME.

8. The unit may now be rolled to its point of installation.

2.12.2 Positioning

Position the system to have access to all sides of the console. Remove cover panels and inspect for any visible damage that might have occurred during shipment.

CAUTION!

ALWAYS USE THE FILE>TURN OFF COMMAND TO PROPERLY EXIT THE SOFTWARE AND SHUTDOWN THE COMPUTERS SO THAT THE MAIN POWER SWITCH CAN BE SWITCHED OFF.

2.12.3 Chamber Fluid

Temperature conditioning of the Model 2900 test chamber utilizes a mixture of propylene glycol and water as a heat transfer fluid. This fluid is circulated by a magnetically coupled centrifugal pump through the refrigeration and heating system and the fluid shell surrounding the test chamber.

2.12.3.1 Chamber Fluid Filling Procedure

1. Ensure main power switch is OFF.
2. Remove top console panel.
3. Locate fluid fill port (under insulation and labeled "Fluid Fill Port").
4. Remove "Red" cap and insert funnel into fluid fill port.
5. Add 2 gallons of 70% propylene glycol. Fill with water until level is approximately 1" (25.4 mm) below the bottom of the fill port or until level touches funnel nozzle tip.

6. Remove funnel and replace fluid fill port cap and insulation.
7. Replace top console panel.

Refer to drawings: [18D29901-1](#), [18D29901-4](#), [18D29909-1](#)

2.12.3.2 Chamber Fluid Draining Procedure

1. Ensure main power switch is OFF.
2. Remove rear console panel.
3. Locate drain hose in the lower left rear corner of the generator (when looking at the back of the generator).
4. Extend hose, remove drain hose cap and empty the chamber fluid into a clean container with a minimum size of 4 gallons. Save the chamber fluid for refilling.
5. To restore hose: grasp hose and rotate counterclockwise ½ turn while pushing hose into left side storage cavity.
6. Replace rear console panel

Refer to drawings: [18D29901-1](#), [18D29901-3](#), [18D29909-2](#)

2.12.4 Reservoir Initial Filling Procedure

The reservoir requires an initial filling prior to first use, then periodic filling thereafter.

Refer to section [5.1 Water Reservoir Level](#) for detailed instruction on how to fill the reservoir.

2.12.5 Setting Supply Pressure Regulator

The supply pressure must be regulated to assure proper control and operation. The goal of the regulation is to remove the spikes that occur during air supply generation.

Note – *It is always recommended to double regulate the air supply; once at the supply and again at the 2900.*

Adjust the 2900's internal pressure regulator (REG) to 10 psiG below the supply pressure, but never above 150 psiG. For example, if the supply pressure indicates 165 psiG then adjust the internal pressure regulator to 150 psiG. If the supply pressure indicates 155 psiG then adjust the internal pressure regulator to 145 psiG (10 psiG below). For the best results operate the generator in run mode at the default flow rate to assure the regulator adjustment corrects for any pressure drop caused by the flow rate.

1. Open the Supply Pressure Dialog by selecting "Supply Pressure" from the Utilities Menu Tab
2. Using a #6 or #8 straight blade screwdriver, rotate stem clockwise to increase pressure and counterclockwise to decrease pressure while monitoring the supply pressure dialog window.

Refer to drawings: [18D29901-1](#), [18D29901-3](#), [18D29901-8](#)

2.13 QUICK START

This section will provide the user a quick start on operating the generator. For detailed information on operating the generator please refer to section [4 ControLog Interface](#).

CAUTION!

DO NOT OPERATE THE GENERATOR WITHOUT CHAMBER FLUID.

2.13.1 Power-Up

To Power-Up the generator perform the following steps:

- Verify that the air supply connection has been made.
 - If using the Series ACS2520 Air Compressor System (ACS)⁶ verify the following:
 - The On/Off valve is open (handle inline).
 - The AC power cable is connected to the ACS box.
 - The remote air compressor control cable is connected from ACS box to generator.
 - The Remote/Manual switch on the left side of the ACS box is in the Remote position.
 - Toggle the power switch located on the left side of the ACS box to ON.
- **Note** – *When the Remote/Manual switch is in the Remote position the ACS compressor will not run when first switched to ON. The compressor is remotely controlled by the 2900 and will not start until the user requests an operation that requires supply pressure.*
- If using another air source, verify the following:
 - Supply is on and properly regulated.
- Verify that AC power cable is connected to the generator.
- Toggle the power switch located at the lower right rear of generator to ON. The generator will begin to boot up.

⁶ Refer to Thunder Scientific's website www.thunderscientific.com for the ACS2520 manual and more information on the ACS2520.

2.13.2 Loading Screen

After the system boots the generator will show a loading screen which will indicate the status of the loading process and will also show the software version of the generator.



2.13.3 ControLog Screen

Upon completion of the loading process the generator will show the main ControLog page and a dialog showing the status of establishing communication with the generator.

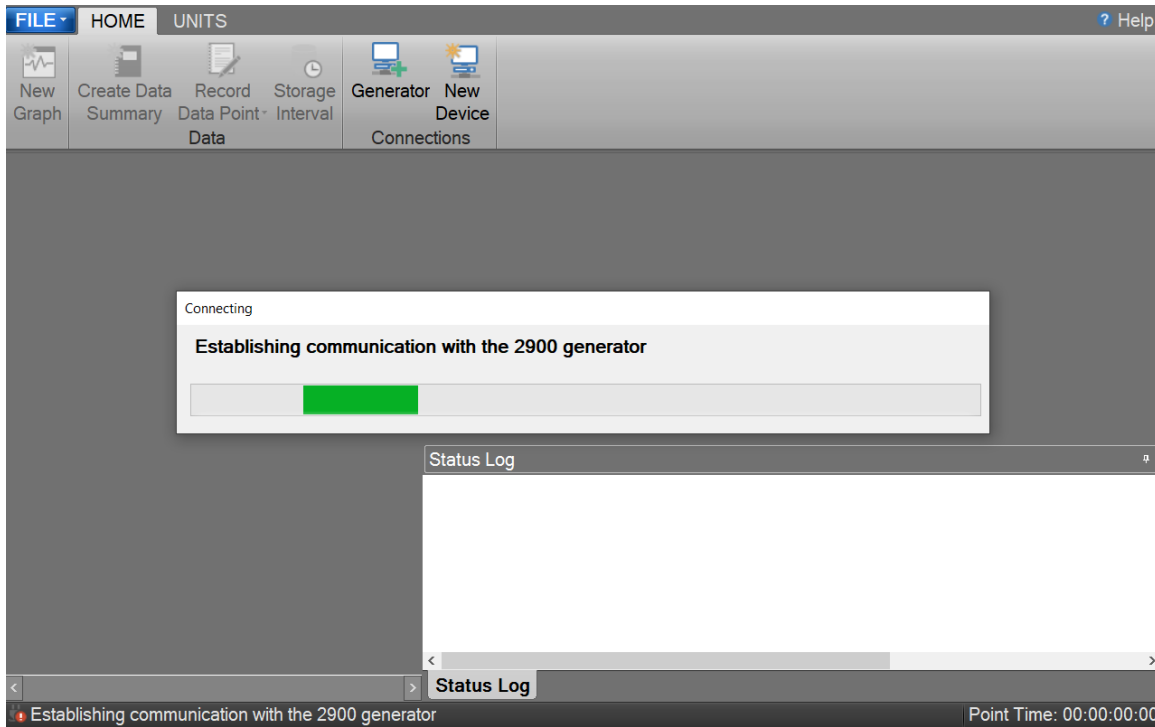

Once communication with the generator is established the generator's parameter and data tabs will be displayed.

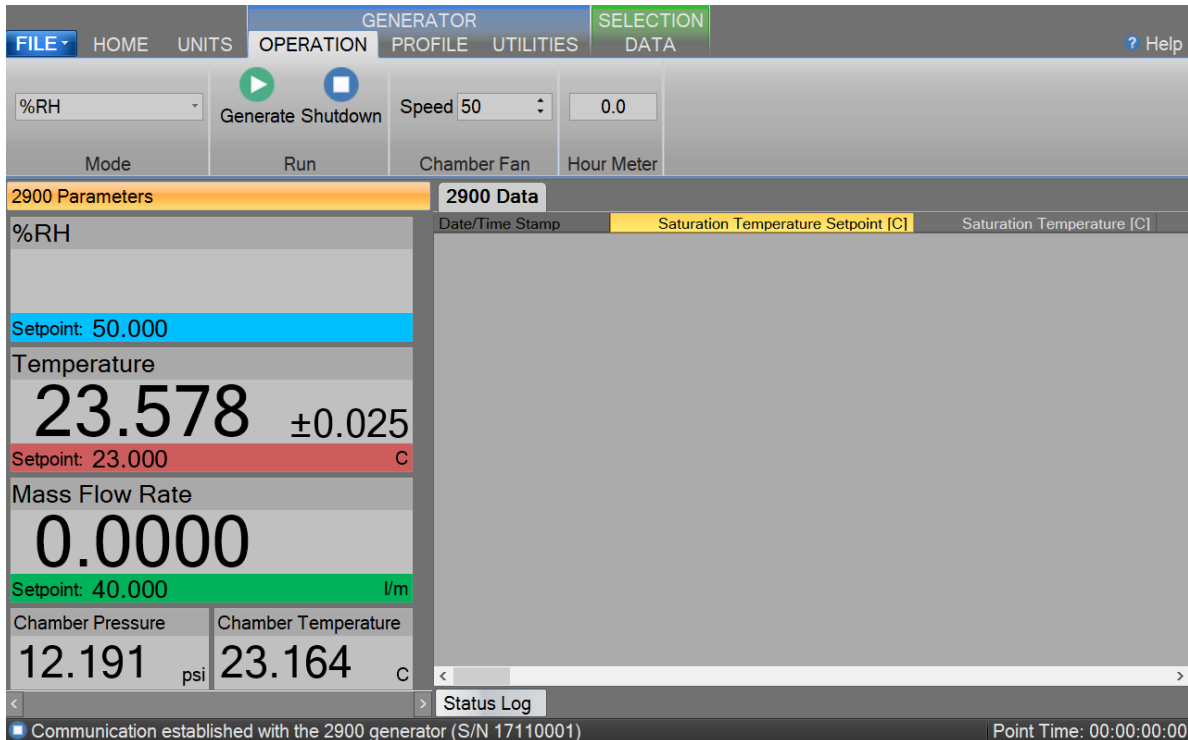

2.13.4 Control Parameters

The Parameter Tab Group is located on the left side of the application and contains a parameter tab for each connected device. The 2900 Parameters contain all the control and measurement parameters critical to the operation of the humidity generator.

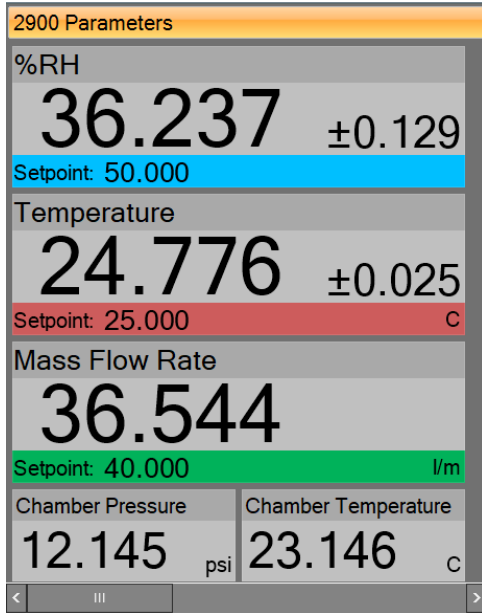

Scrolling the Parameters

Each Parameter Tab can be scrolled up and down to show additional parameters.

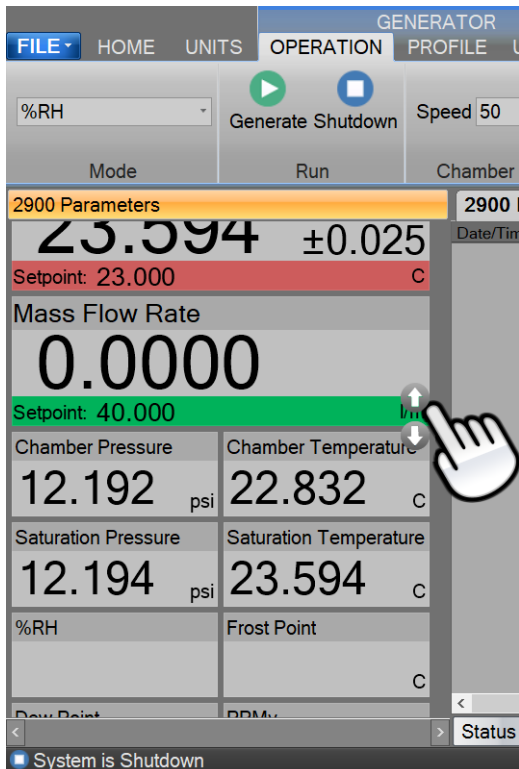

2.13.4.1 Setpoint Tile

The Setpoint Tiles allow the user to control the operation of the humidity generator by changing the desired setpoint that the generator will control to. The Tiles contain 5 key parts; a header with the Parameter Name, the Actual Value, the real-time Uncertainty Value, the Setpoint Value and the Unit the values are displayed in. Each setpoint tile has a colored bar to allow quick indication of the what the tile is displaying and in turn what the system is controlling. Blue is for the humidity that is being generated, red is for the temperature that the system is controlling to and green is for the flow rate the system is generating at.

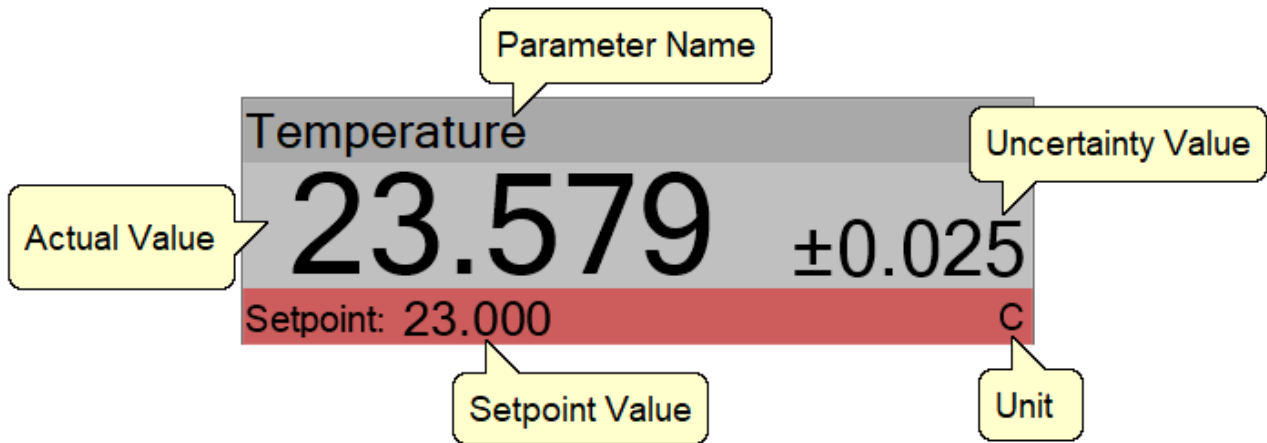

2.13.4.1.1 Changing Setpoints

To change a setpoint, click on the setpoint tile that you would like to change. A setpoint entry box will appear. For example, to change the Percent Relative Humidity setpoint click on the %RH setpoint tile.

Enter Setpoint Value

Enter the %RH you would like to generate.

Ok Cancel

Enter the new value into the Setpoint Entry box and select Ok. Notice that the Percent Relative Humidity setpoint value updates to the new value and the actual values begin moving toward the new setpoint.

2.13.4.2 Value Tile

The Value Tiles display an actual value of a given parameter to the user. The Tiles contain 3 key parts; a header with the Parameter Name, the Actual Value and the Unit the value is displayed in.

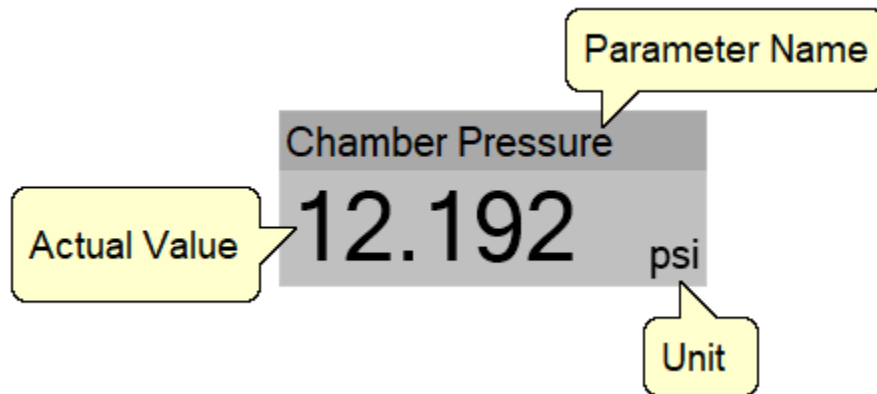

2.13.5 Control Modes

The user can change the operating mode of the 2900 by selecting from the drop-down menu within the Mode group on the Generator's Operation menu tab.

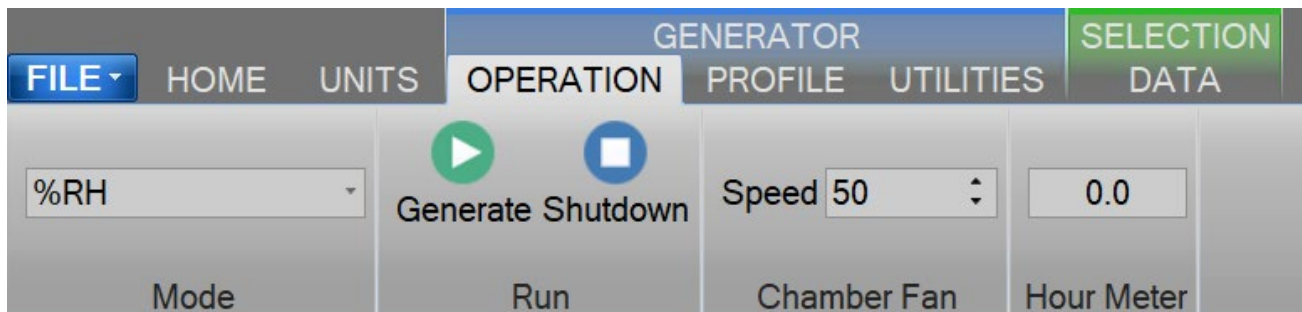

The drop-down allows the user to select between %RH, Frost Point, Dew Point, PPMv, PPMw, and Saturation Pressure.

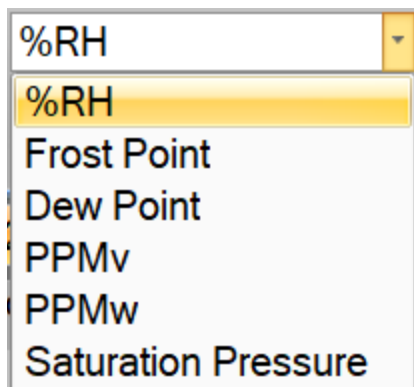

2.13.6 Generating and Shutting down

The Run Menu allows the user to run the 2900 manually.

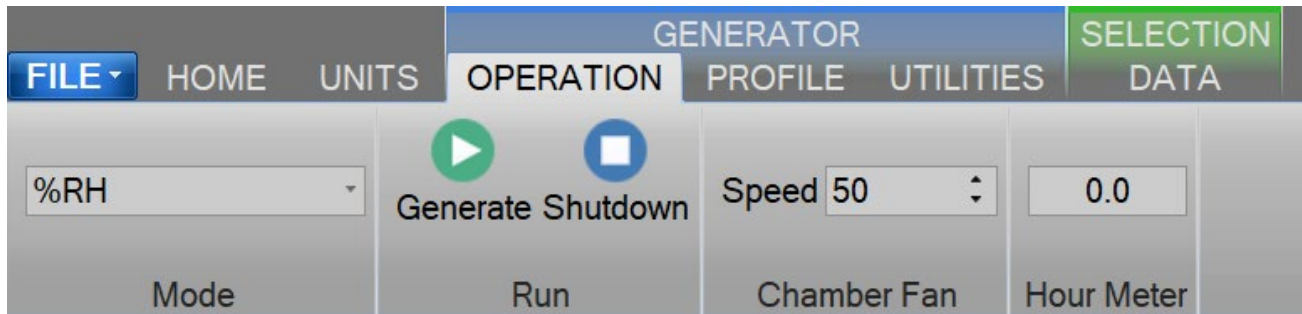

The user can select to Generate or Shutdown.

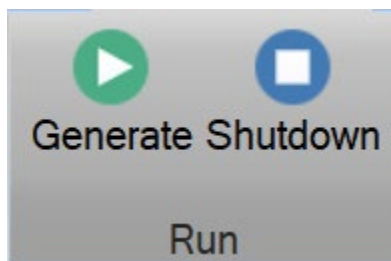

2.13.6.1 Generate Mode

Selecting Generate from the run menu commands the 2900 into generate mode. When in the Generate mode of operation, the system will control at the currently entered setpoints. Anytime a setpoint is changed, the system immediately begins adjusting to that new value, and will control at the new point. The Generate mode also allows you to change the humidity control mode at any time. For instance, the system may be controlling %RH, then you may immediately switch to Dew Point control mode.

2.13.6.2 Shutdown

Selecting Shutdown from the run menu commands the 2900 to shutdown. The 2900 may be shutdown whenever it is generating. When stopped, all system functions shutdown, pressure is vented, and the idle Control/Display screen is shown. During this idle time, when the 2900 is stopped, gas is not flowing through the generator.

2.13.7 Power-Off

To turn the system off select the “Turn Off” command.

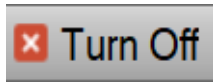

The “Turn Off” command is located under the “File” menu.

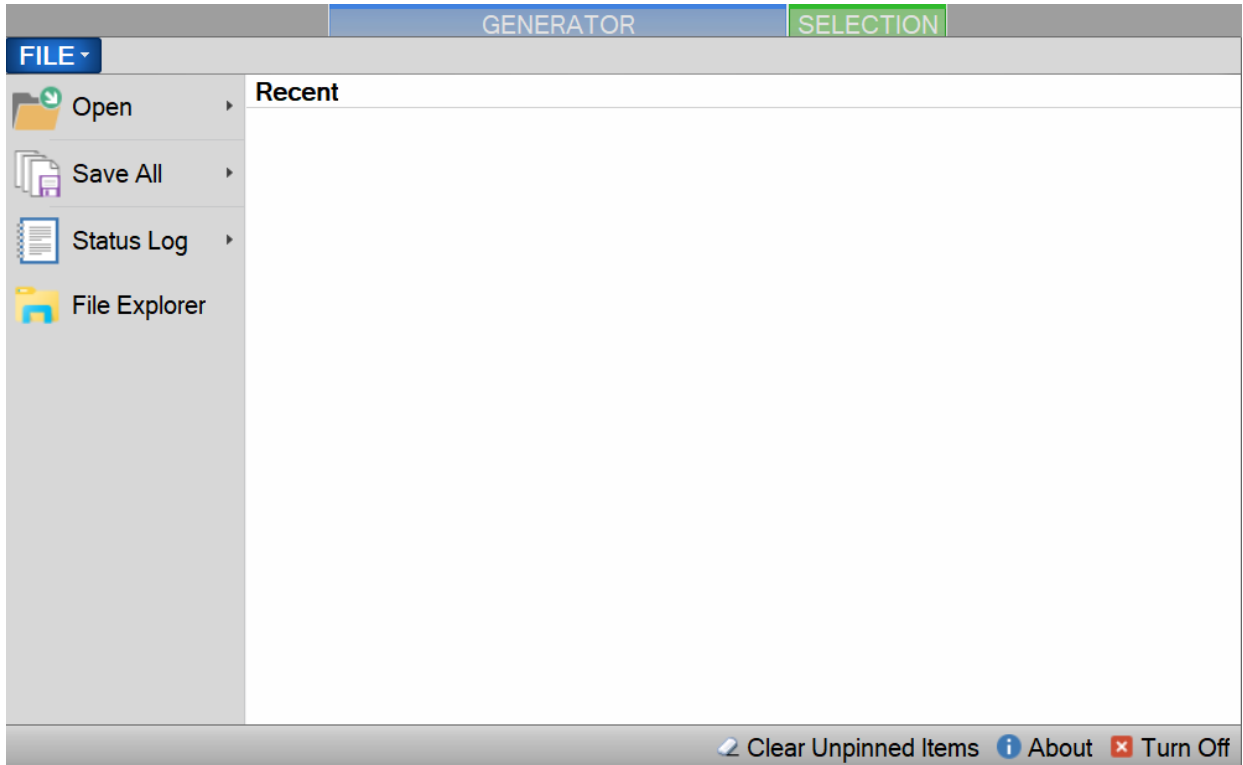

The Turn Off command will properly exit the software and shutdown the computers so that the main power switch can be switched off.

Note – Always perform a [Shutdown](#) from the Operation Menu Tab before turning off the System.

If there is current data that has yet to be saved the user will be asked to save the data before the system shuts down. Selecting this command when the generator is generating will result in the automatic shutdown of the generator.

The user is safe to switch the power switch to OFF once the PC has shut down completely (display goes blank).

CAUTION!

TURNING OFF POWER WITHOUT SHUTTING DOWN THE SYSTEM
FIRST CAN CORRUPT THE EMBEDDED WINDOW SYSTEM DRIVE.

2.13.8 Set Date and Time

The user can change the current system date and time through the status bar context menu.

Note – *To avoid time stamp confusion only change the system date and time when the generator is shutdown and not recording data.*

Start by long pressing or right clicking anywhere within the status bar. A long press is when you touch and hold the screen.



Long enough for a square selection box to appear.



Releasing will open the status bar context menu.

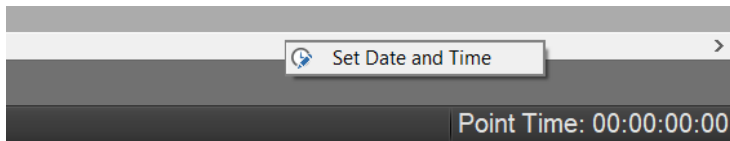

Select “Set Date and Time” from the context menu to open the system Date and Time dialog.

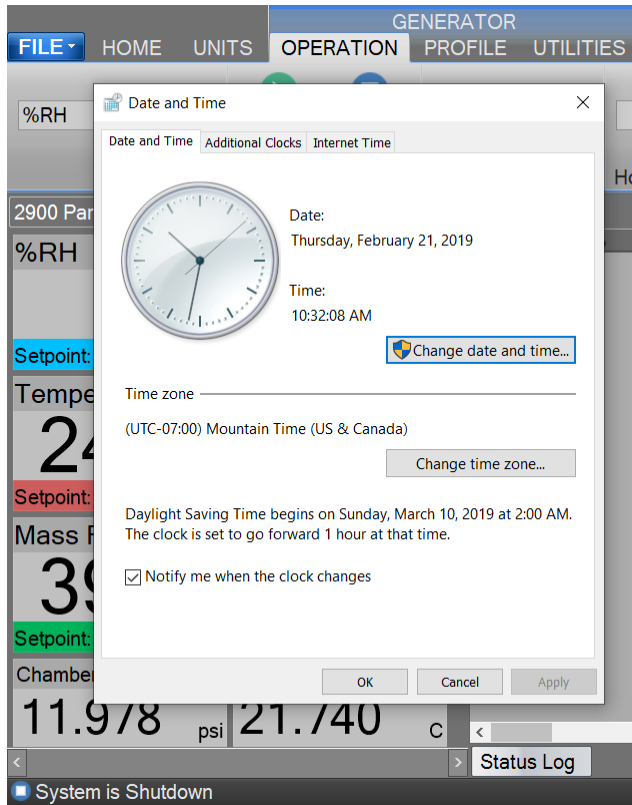

2.13.9 Help

The Help Menu located on the upper right side of the screen, allows the user to open the 2900 System Manual.

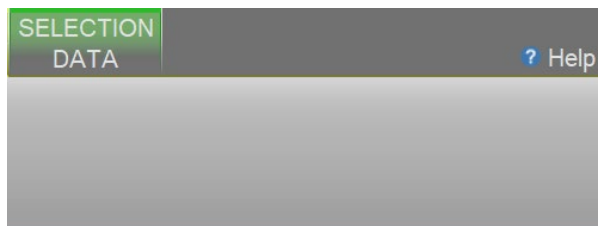

Note – Refer to the Thunder Scientific website (www.thunderscientific.com) for the latest manual edition and other information on your Model 2900 Humidity System.

3 PRINCIPLE OF OPERATION

The Model 2900 humidity generation system is based on the two-pressure principle. This process (shown below in elemental schematic form) involves saturating air or nitrogen, with water vapor at a given temperature and pressure. The saturated high-pressure gas flows through an expansion valve where it is isothermally reduced to test pressure. The indications of saturation temperature, saturation pressure, chamber temperature, and chamber pressure are then used in the determination of all hygrometric parameters such as %RH, Dew Point, PPM, etc. Humidity generation by this system does not depend upon measuring the amount of water vapor, but rather is dependent on the measurements of temperature and pressure alone. The precision of the system is determined by the accuracy of the temperature and pressure measurements, and on the constancy of them throughout.

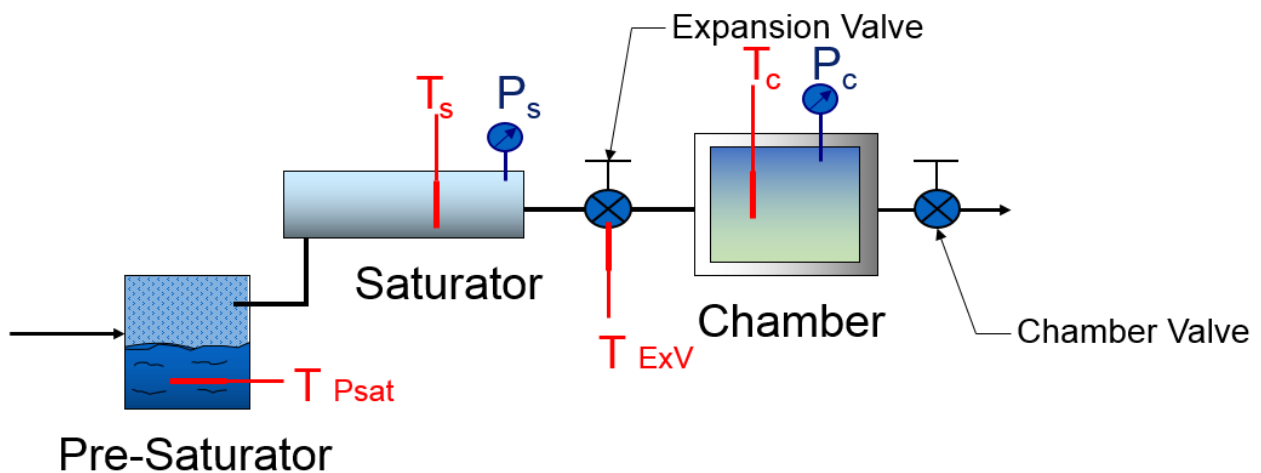

3.1 PRE-SATURATION (T_{Psat})

The air stream of a two-pressure generator must be 100% saturated with water vapor at saturation temperature on the high-pressure (saturator) side of the expansion valve. This is accomplished by first passing the air stream through a "Pre-Saturator". The Pre-Saturator is a vertical pressure vessel presenting a water surface to the incoming air stream and is maintained at a temperature warmer than saturation temperature conditions. The Pre-Saturator temperature probe is used in the control of the Pre-Saturator heaters, which when activated, are used to control this temperature offset.

3.2 EXPANSION VALVE (T_{ExV})

The expansion valve temperature probe is used in the control of the expansion valve heater, which when activated, is used to warm the expansion valve body, offsetting the cooling effects due to gas expansion. This expansion valve temperature is always maintained above the saturation temperature.

3.3 SATURATION TEMPERATURE (T_s)

The saturation temperature probe is used to measure the fluid temperature at which the airstream is fully saturated with water vapor. This is a fundamental measurement for a Two-Pressure humidity generator. Saturation temperature is controlled directly through the Temperature setpoint.

Refer to section [2.9 Specifications](#) for range.

Note - The 2900 can only operate for a finite amount of time at or below 0 °

3.4 CHAMBER TEMPERATURE (T_c)

The chamber temperature probe is used to measure the temperature within the test chamber. This is a fundamental measurement for a Two-Pressure humidity generator. Chamber temperature is controlled indirectly through the temperature setpoint.

Refer to section [2.9 Specifications](#) for range.

3.5 SATURATION PRESSURE (P_s)

The Saturation Pressure transducer measures and controls the absolute pressure at which airstream is fully saturated with water vapor at saturation temperature conditions. This is a fundamental measurement for a Two-Pressure humidity generator. Saturation pressure can be controlled directly using the Saturation Pressure setpoint or indirectly through the humidity mode setpoint.

Refer to section [2.9 Specifications](#) for range.

3.6 CHAMBER PRESSURE (P_c)

The chamber pressure transducer is used to measure the pressure within the test chamber. This is a fundamental measurement for a Two-Pressure humidity generator. Chamber pressure is ambient pressure and is not controlled.

Refer to section [2.9 Specifications](#) for range.

3.7 HUMIDITY FORMULAS

The humidity (or water vapor content) of a gas may be expressed in a variety of ways. While some basic understanding of humidity is helpful, thorough knowledge of the formulas and their relationships to the 2900 is not a requirement for successful operation of the generator. Refer to the HumiCalc with Uncertainty Reference Manual for a full description of the equations used by the 2900 to generate a known humidity and corresponding uncertainty value.

4 CONTROLOG INTERFACE

This section will provide the user with a detailed overview of ControLog's layout and design. It is intended to allow the user to gain familiarity with ControLog's user interface. The sections following will provide a deeper operational view of the functionality that ControLog offers.

The ControLog application is composed of five basic features: Ribbon Style Menu Bar, Parameter Tab Group, Data and Graph Tab Group, Information Tab Group and the Status Bar. Each feature is designed to be intuitive to use and to provide the user with detailed information on the operation of the generator and/or connected device(s).

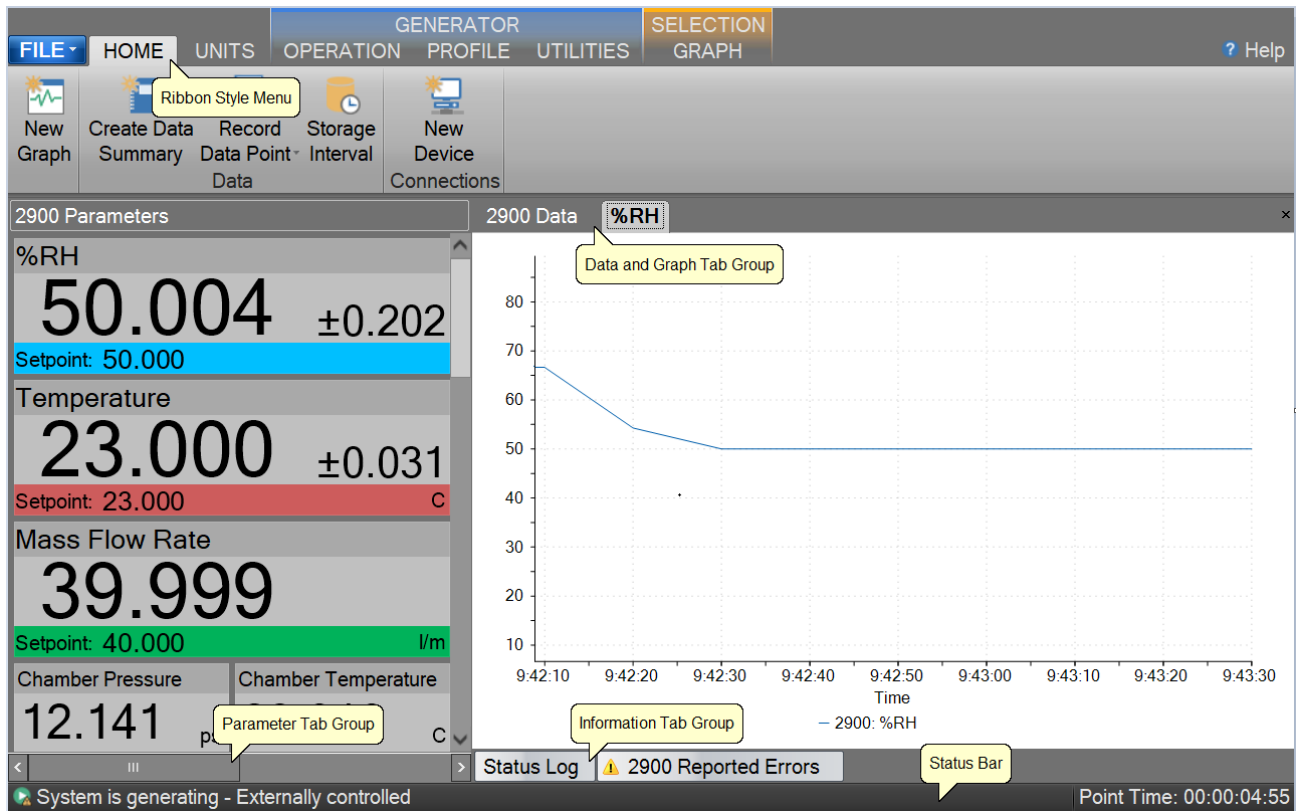

4.1 MENU BAR

The Ribbon Style Menu Bar is located at the top of the application and contains various selectable menu groups, which provide access to the different ControLog functions and controls. The Generator group provides commands that are directly related to the operation of the generator such as Operation, Profile, and Utilities. The Selection group is dynamic and provides commands based on the Data and Graph Tab Group tab that is currently selected. For example, if a data tab is selected, commands related to data will be available. If a graph tab is selected, then commands related to the graph will be available.

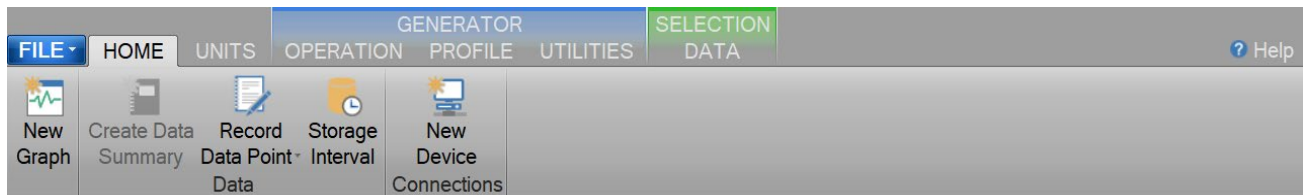

4.1.1 File Menu Tab

The File Menu allows the user to perform file specific commands to open previous data files, profiles and device configurations. It also allows the user to save all open data or graphs, clear the status log, save the status log, restore the tab layout, about the application and shutdown system.

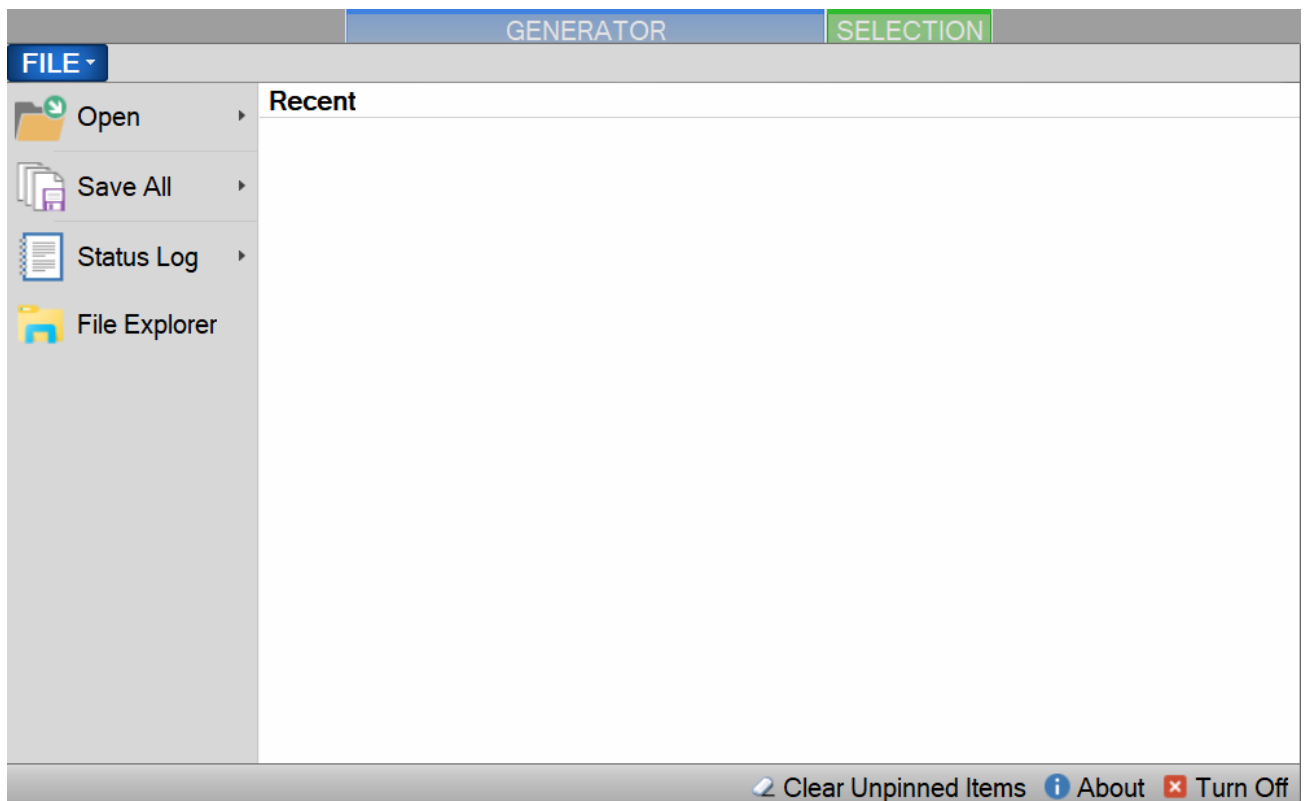

4.1.1.1 Open Data File

The Open file menu command allows the user to open previous data files for further review and analysis, device configurations for device data logging and profiles for generator automation.

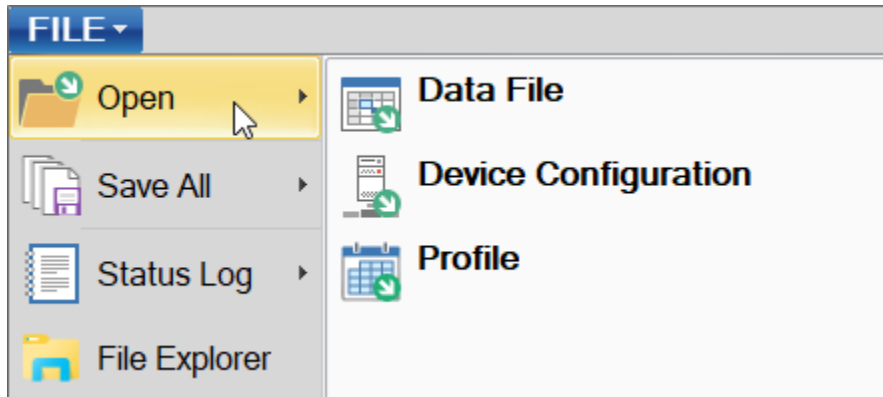

Selecting one of these commands will open a file dialog that will allow the user to browse to the desired location for the file to open.

ControLog can open data saved in the follow type and format:

- Text File (Comma Delimited) (*.csv;*.txt)
- Text File (Tab Delimited) (*.dat;*.txt)
- Excel Workbook (*.xlsx;*.xls)
- Backup ControLog File (*.backup)

The user can also view and select to open recent files and has the option to “Pin” the file for quicker access later on. This can be very useful if you have a device configuration that is often used or a commonly used profile as it removes the process of navigating and selecting the file each time.

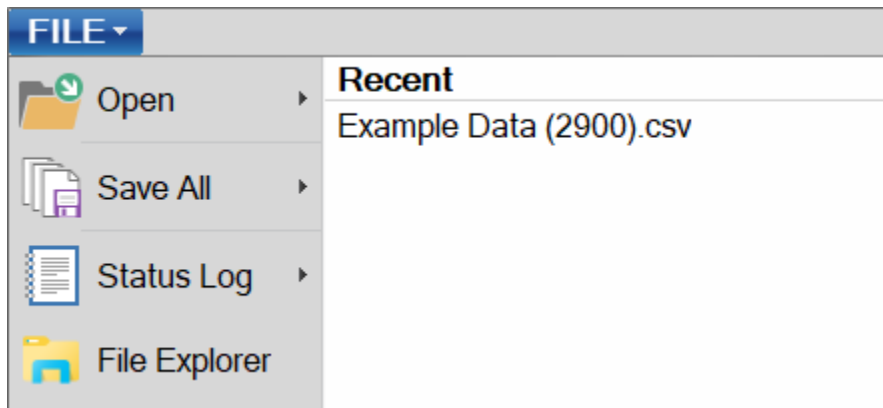

4.1.1.2 Save All Data

The Save All file menu command allows the user to save all current open data tabs to individual files using a common name. This feature allows the user to quickly save multiple data tabs in a single operation.

Selecting this command will open a save file dialog that will allow the user to specify the name and browse to the desired location to save the file.

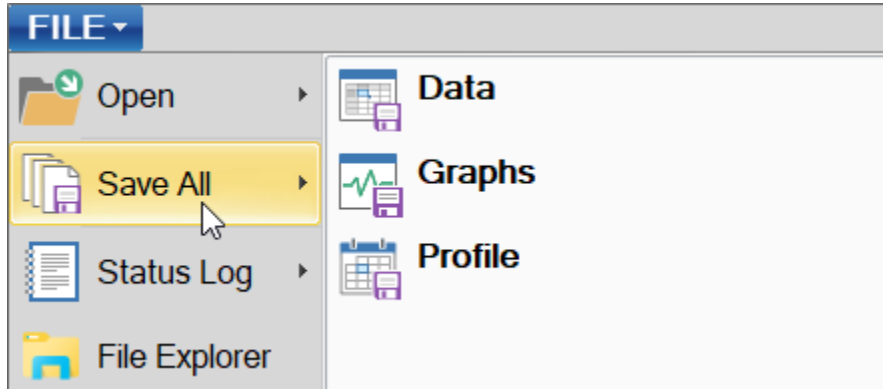

ControLog can save data in the following type and format:

- Comma-Separated Values (*.csv)
- Text File (Comma Delimited) (*.txt)
- Text File (Tab Delimited) (*.txt)
- Excel Workbook (*.xlsx)
- Excel 97-2003 Workbook (*.xls)

Example: If the user had two data tabs open, one called “2900 Data” and the other called “Agilent 34970A Data” and the user wanted to save the files as Excel Workbooks using the name “Test Data 10Dec15”. ControLog would save two files to the user specified location with the follow names:

- Test Data 15Oct17 (2900).xls
- Test Data 15Oct17 (Agilent 34970A).xls

4.1.1.3 Status Log

The Status Log file menu command allows the user to Clear or Save the status log.

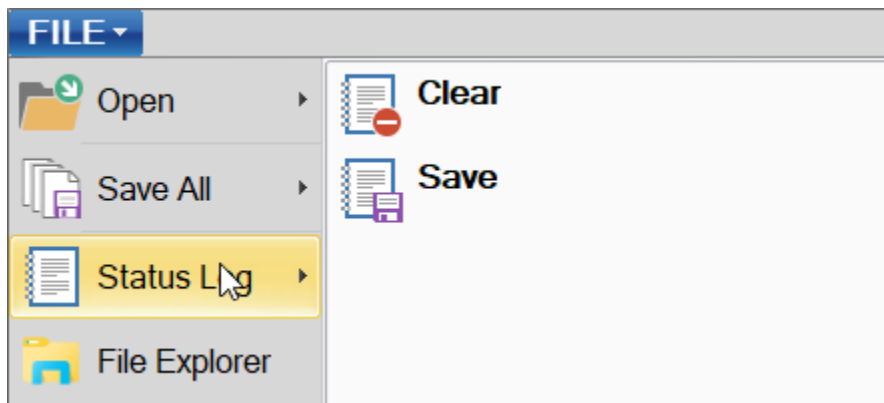

The Clear command allows the user to clear all current entries in the status log. The user will be asked to save the status log data before the log is cleared.

The Save command allows the user to save the current entries in the status log. Selecting this command will open a save file dialog that will allow the user to specify the name and browse to the desired location to save the file. All status log files are saved in HTML format (*.html).

4.1.1.4 File Explorer

Opens a Windows file explore to allow the user to manage files. This can be used to easily copy data and report files from the 2900 to an extern USB drive.

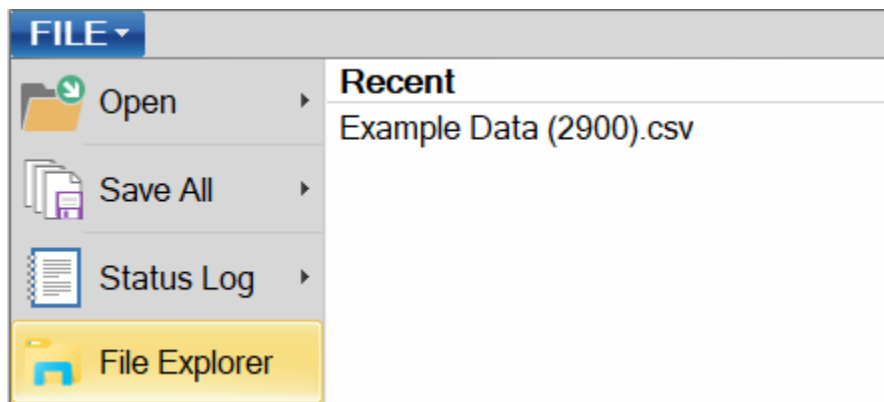

4.1.1.5 Clear Unpinned Items

Clears all unpinned items in the list of recent files.

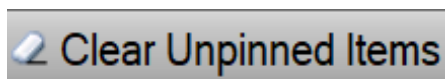

4.1.1.6 About ControLog

The About ControLog help menu command opens a dialog giving information on the ControLog application including software version numbers and build dates.

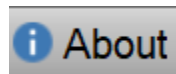

4.1.1.7 Turn Off

The Turn Off command allows the user to properly exit the software and shutdown the computers so that the main power switch can be switched off. If there is current data that has yet to be saved the user will be asked to save the data before the system shuts down. Selecting this command when the generator is generating will result in the automatic shutdown of the generator.

Note – Always perform a [Shutdown](#) from the Operation Menu Tab before commanding a Shutdown System.

The user is safe to switch the power switch to OFF once the PC has shut down completely (display goes blank).

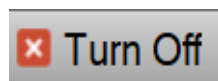

CAUTION!

TURNING OFF POWER WITHOUT SHUTTING DOWN THE SYSTEM
FIRST CAN CORRUPT THE EMBEDDED OPERATING SYSTEM.

4.1.2 Home Menu Tab

The home menu tab allows the user to create new graphs and data summaries, record data points, connect to the generator and create new device connections. It also allows the user to change ControLog's displayed units. The Temperature, Pressure, Flow Rate, Density and Enthalpy units can be changed.

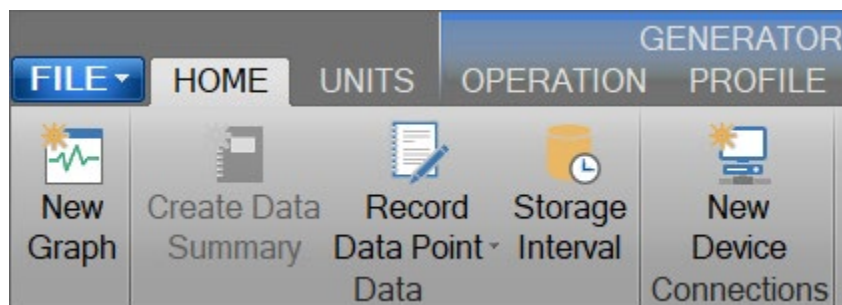

4.1.2.1 New Graph

The New graph menu command allows the user to create a new graph. Selecting this command will open a New Graph Wizard dialog that will step the user through the selection process of what data the user would like to include in the new graph. This operation is always available.

4.1.2.2 Create Data Summary

The Create Data Summary data command allows the user to create a summary of any currently opened data. The feature lets the user specify what items, from which device, and at what intervals to include in the data summary. The data summary can also calculate error between the specified standard and the device under test. This operation is available whenever there is an open Data tab that contains data.

For more information, refer to section [8 Data and Data Summary](#)

4.1.2.3 Record Data Point

The Record Data Point data command allows the user to record certain data items from any currently connected device either manually, with each manual device entry or at the completion of each soak phase in an auto profile. The user can specify the number of prior data points to include and has the option to automatically calculate average and or standard deviation of the prior data points. There are two submenus for this menu command; Settings and Take Point. This operation is available whenever device or generator data is being logged. The user can manually take a point using the button or by using the keyboard shortcut “Ctrl-P”.

If the user has not configured the system to record data points, then ControLog will ask the user if they would like to define the settings before taking a point.

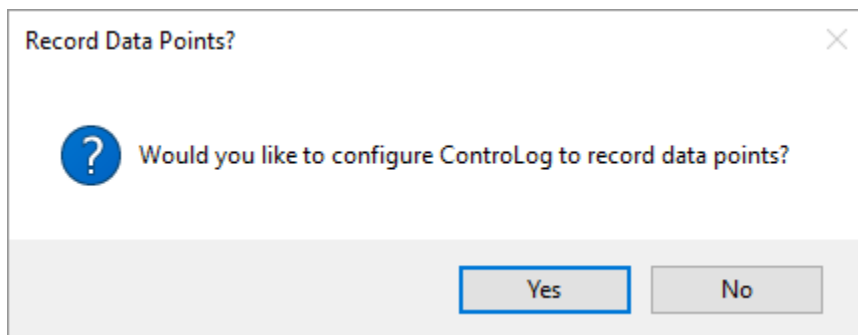

4.1.2.3.1 Settings

The Settings submenu allows the user to define which data items and from which connected device they would like to record when a point is taken. They can also define the number of points prior to include and whether to calculate average and or standard deviation. The user can also configure when to take points, either manually, at the end of a profile soak phase or when a manual device entry is taken.

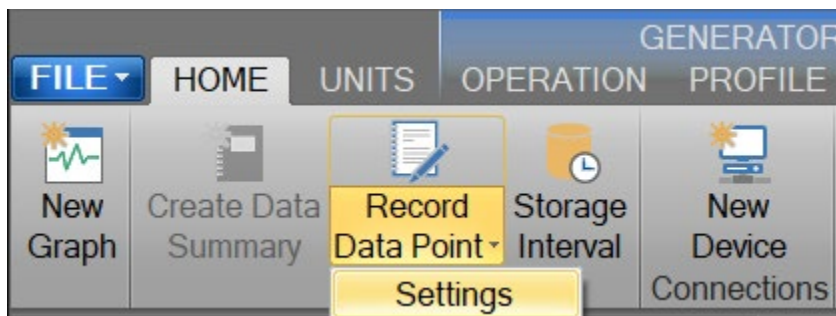

For more information, refer to section [8 Data and Data Summary](#)

4.1.2.4 Data Storage Interval

The Data Storage Interval data command allows the user to change the storage interval that data is recorded. This is the rate at which data is recorded to the data tabs for all connected devices. Selecting this command will open the “Data Storage Interval” dialog that will allow the user to change the data storage interval during the generate operation. If the “Set as Default” is checked, the new value will become the default start up interval. If not checked, the new value will only affect the current session.

IMPORTANT!

STORING AND MAINTAINING DATA CAN BECOME A TIME-CONSUMING PROCESS. THE MORE DATA THAT IS STORED IN THE DATA TAB, THE SLOWER AND LESS RESPONSIVE THE COMPUTER MAY SEEM. FOR THIS REASON, SOME CONSIDERATION SHOULD BE GIVEN TO THE AMOUNT OF DATA DESIRED, THE OVERALL TIME SPAN OF THE DATA (I.E. HOURS, POSSIBLY DAYS), AND ULTIMATELY THE DATA INTERVAL.

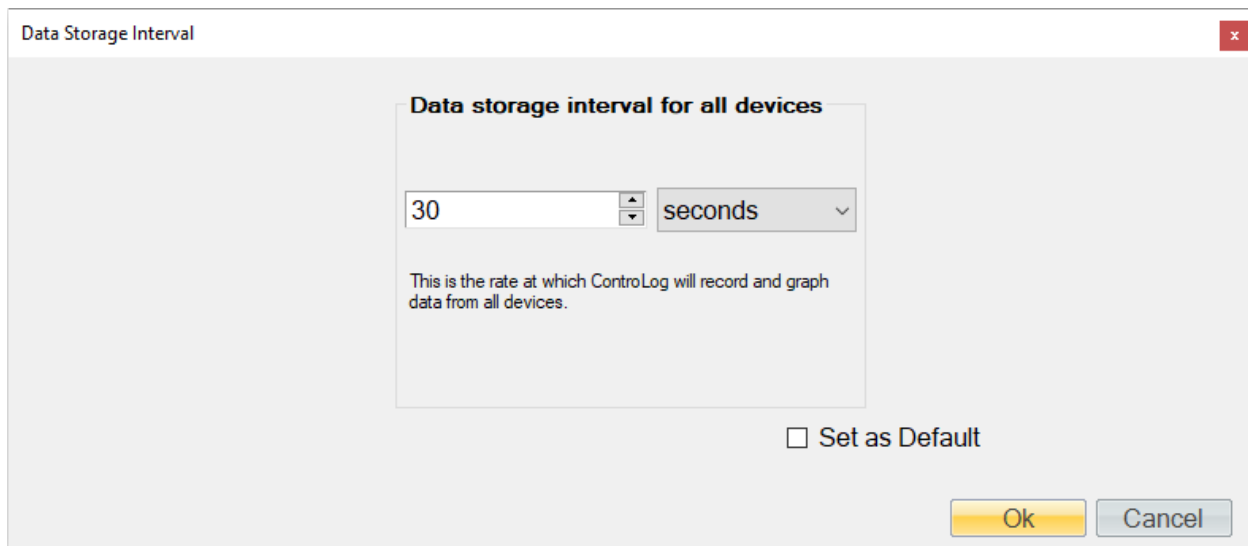

Note - Data is only recorded while the 2900 is in generate mode.

4.1.2.5 New Device

The New Device connection command allows the user to create a new device connection. Selecting this command will open a Connection Wizard dialog that will step the user through the process of creating a new connection to a device.

For more information, refer to section [10 Connections](#)

4.1.3 Units Menu Tab

The Units Menu Tab allows the user to change ControLog's displayed units. The Temperature, Pressure, Flow Rate, Density and Enthalpy units can be changed.

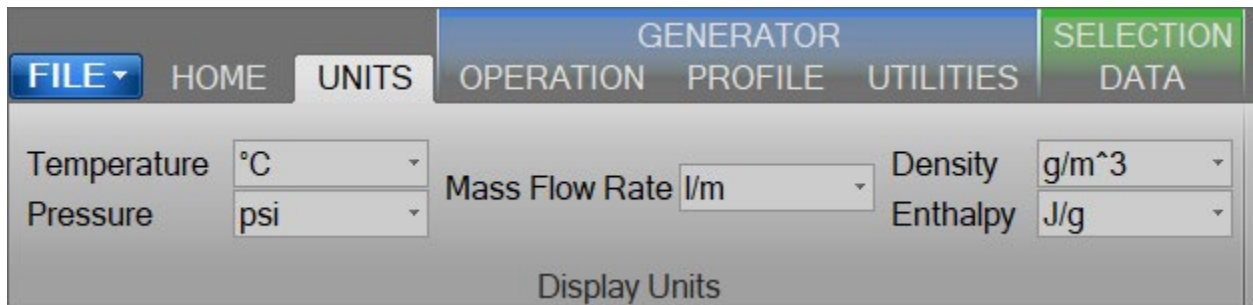

Note - All parameter tabs and graph tabs will be updated with the selected unit, but the data tabs will not change. All data tab values remain in SI units which provide a consistent unit base for saved data.

4.1.3.1.1 Temperature Unit

The Temperature Unit allows the user to change the displayed units for temperatures.

Available temperature units:

- °F
- °C
- K

4.1.3.1.2 Pressure Unit

The Pressure Unit allows the user to change the displayed units for pressure.

Available pressure units:

- psi
- atm
- Pa
- hPa
- kPa
- MPa
- bar
- millibar

4.1.3.1.3 Flow Unit

The Flow Unit allows the user to change the displayed units for flow.

Available flow units:

- l/m
- l/h
- cfm
- cfh

4.1.3.1.4 Density Unit

The Density Unit allows the user to change the displayed units for density.

Available density units:

- g/L
- g/m³
- lb/ft³

4.1.3.1.5 Enthalpy Unit

The Enthalpy Unit allows the user to change the displayed units for enthalpy.

Available enthalpy units:

- btu/lb
- J/g

4.1.4 Operation Menu Tab

The Operation Menu Tab gives the user the ability to control the operation of the generator, from what humidity operating mode to the startup and shutdown of the generator.

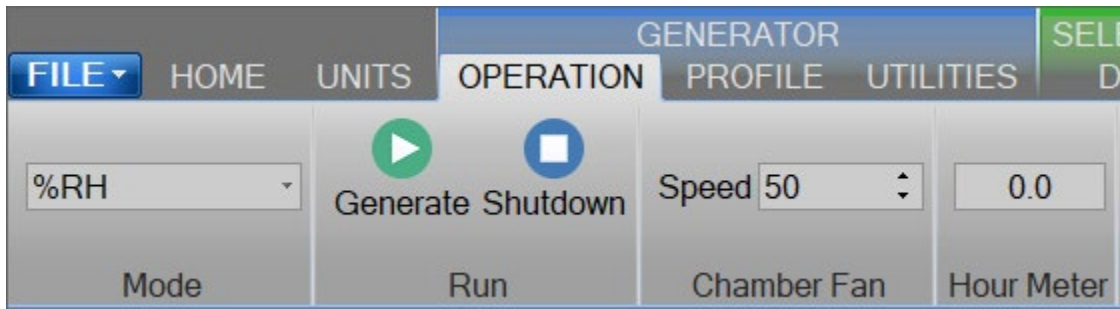

4.1.4.1 Mode

The Mode Menu allows the user to change the operating mode of the 2900. It allows the user to select between %RH, Frost Point, Dew Point, PPMv, PPMw, and Saturation Pressure.

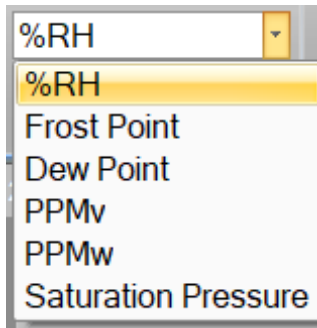

4.1.4.1.1 %RH Control Mode

The %RH Control Mode, %RH, is controlled at a constant value by varying saturation pressure, P_s , to compensate for any changes in saturation temperature, T_s , chamber temperature, T_c , or chamber pressure, P_c . While %RH is held constant, all other humidity parameters may vary.

4.1.4.1.2 Frost Point Control Mode

The Frost Point Control Mode, T_f , is controlled at a constant value by varying the saturation pressure, P_s , to compensate for changes in either saturation temperature, T_s , or chamber pressure, P_c . While Frost Point is held constant other humidity parameters may vary. Frost Point is independent of chamber temperature.

4.1.4.1.3 Dew Point Control Mode

The Dew Point Control Mode, T_d , is controlled at a constant value by varying saturation pressure, P_s , to compensate for any changes in either saturation temperature, T_s , or chamber pressure, P_c . While Dew Point is held constant, other humidity parameters may vary. Dew Point control mode is valid both above and below 0 °C, and Dew Point is independent of chamber temperature.

4.1.4.1.4 PPMv Control Mode

The PPMv Control Mode is controlled at a constant value by varying saturation pressure, P_s , to compensate for any changes in saturation temperature, T_s . While PPMv is held constant, other humidity parameters may vary. PPMv is independent of chamber pressure and chamber temperature.

4.1.4.1.5 PPMw Control Mode

The PPMw Control Mode is controlled at a constant value by varying saturation pressure, P_s , to compensate for any changes in saturation temperature, T_s . While PPMw is held constant, other humidity parameters may vary. PPMw is independent of chamber pressure and chamber temperature.

4.1.4.1.6 Saturation Pressure Control Mode

The Saturation Pressure Control Mode, P_s , is controlled at a constant value independent of any other pressure, temperature, or humidity value. While saturation pressure is held constant, all humidity parameters may vary.

4.1.4.2 Run Menu

The Run Menu allows the user to run the 2900 manually in generate mode. The Run menu also allows the user to manually shutdown the 2900.



4.1.4.2.1 Generate Mode

Selecting Generate from the run menu commands the 2900 into generate mode. Generate mode is used to operate the system when exact humidity points or associated time intervals have not been determined, when data must be viewed and/or verified manually before proceeding to the next humidity point, or when more immediate control over the generated humidity is required. When in the Generate mode of operation, the system will control at the currently entered setpoint indefinitely. Anytime a setpoint is changed, the system immediately begins adjusting to that new value, and will control at the new point indefinitely. Generate mode offers the flexibility to change the setpoint at any time and does not force you into any set sequence or for any prescribed amount of time. The Generate mode also allows you to change the humidity control mode at any time. For instance, the system may be controlling Frost Point, then you may immediately switch to PPMv control mode.

4.1.4.2.2 Shutdown

Selecting Shutdown from the run menu commands the 2900 to shutdown. The 2900 may be shutdown while generating. When stopped, all system functions shutdown, pressure is vented, and the idle Control/Display screen is shown. During this idle time, when the 2900 is stopped, gas is not flowing through the saturator.

4.1.4.3 Chamber Fan Menu

The Chamber Fan Menu allows the user to control the 2900 chamber fan speed. The chamber fan speed can be controlled from 0 (off) to 100 (max speed). The user can specify a speed by entering a value directly or by using the up/down arrows to increment the speed by 10.

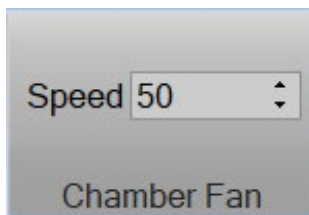

Note – *The chamber fan will only operate when the system is generating.*

Refer to drawing: [18D29908](#)

4.1.4.4 Hour Meter

The Hour Meter allows the user to see the number of operational hours the generator has on it. The hour meter indicates the number of hours the generator has been operated in the generate mode.

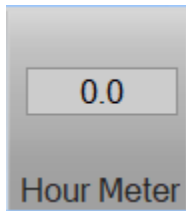

4.1.5 Profile Menu Tab

The Profile Menu Tab allows the user to manage Auto Profiles. Auto Profiles give the user the ability to program a set of humidity and temperature test points and dwell times that will automate the 2900 generation process. The profile menu is dynamic and has operations that are specific to the profile tab. Specific operations will be hidden when another non-profile tab is selected.

The Auto Profiling feature is very similar to the Generate mode with the main exception that profiling relies on a predefined list of setpoints referred to as a profile. The user configurable profile is used as ControLog's road map during Auto Profile operation. It defines which setpoint values to go to, at what rate to go from one setpoint to another, and how long to stay at a specific setpoint before moving to the next one.

For more information, refer to section [9 Profiling](#).

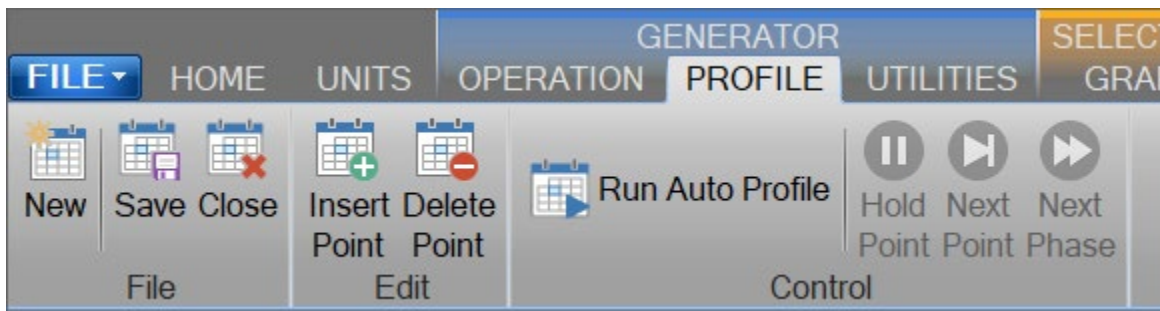

4.1.5.1 New Profile

The New profile command allows the user to create a new Auto Profile.

4.1.5.2 Save Profile

The Save profile command allows the user to save the currently opened Profile. Selecting this command will open a save file dialog that will allow the user to specify the name and browse to the desired location to save the file. ControLog Auto Profiles are saved in XML format with a *.profile extension.

4.1.5.3 Close Profile

The Close profile command allows the user to close the Profile tab. Selecting this command will close the Profile tab, but if the profile has not been saved, ControLog will ask the user to save the profile before closing the Profile tab.

4.1.5.4 Insert Point

The Insert Point command allows the user to insert new profile points between existing points. ControLog will insert a new point at the selected location and will automatically predict the values.

4.1.5.5 Delete Point

The Delete Point command allows the user to delete the selected profile point.

4.1.5.6 Run Auto Profile

The Run Auto Profile command allows the user to start an Auto Profile. Selecting this command will open the Profile Starting Point dialog which allows the user to select which point in the profile they would like to start the profile on.

4.1.5.7 Hold Point

The Hold Point profile command allows the user to hold or pause the current Auto Profile point. Selecting Hold Point pauses the current point, allowing the system to remain indefinitely at the current point. While in a hold mode, the system is prevented from completing the ramp, assurance, or soak phases for a point. To resume the profile point, select the menu item again. This re-enables the point and allows the profile to resume normal operation.

4.1.5.8 Next Point

The Next Point profile command allows the user to skip to the next point in the Auto Profile. Selecting Next Point manually advances to the next point, skipping any remaining ramp, assurance, or soak phase.

4.1.5.9 Next Phase

The Next Phase profile command allows the user to skip to the next phase in the Auto Profile. Selecting Next Phase manually advances to the next phase. It causes Ramp Phase to proceed to the Assurance or Soak Phase, Assurance to proceed to Soak, or Soak to proceed to Ramp of the next profile point. This allows for early manual termination of any phase within a profile point.

4.1.6 Utilities Menu Tab

The Utilities Menu Tab gives the user access to various utilities functions such as Fluid Levels, Supply Pressure, generator Calibration, System Parameters, Expanded Parameters, generator Uncertainty and Access Control.

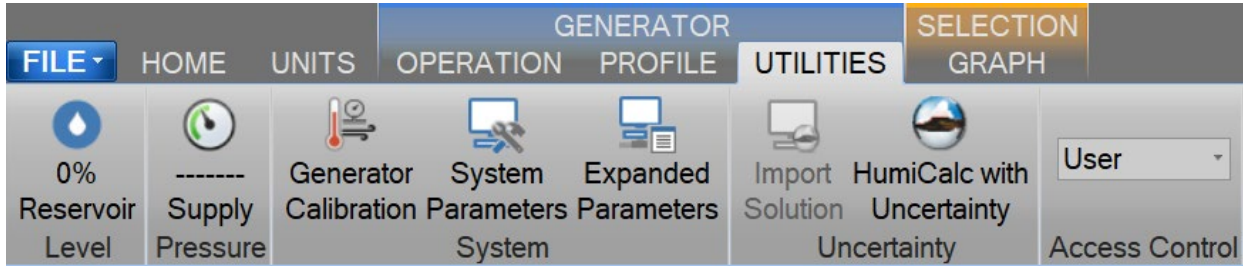

4.1.6.1 Reservoir Level

The Reservoir Level indicates the current level of the water reservoir and when pressed, opens up the 2900 fluid level interaction dialog that allows the user to view the state of the various fluid levels and liquid level states.

For more information, refer to section [5 Fluid Levels](#).

4.1.6.2 Supply Pressure

The Supply Pressure indicates the current supply pressure and when pressed opens a dialog box for the user to view the current supply pressure (in gauge). If the generator is shutdown, this command will also open the supply pressure solenoid (and start the airbox is equipped). The exact pressure value will vary based on the air supply connected to the generator.

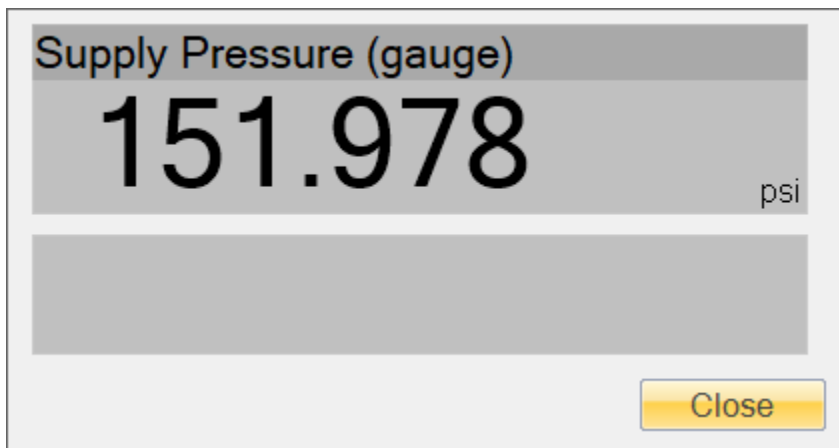

If the supply pressure is set too high a warning message will be displayed. The user will need to reduce the pressure regulator until the message disappears.

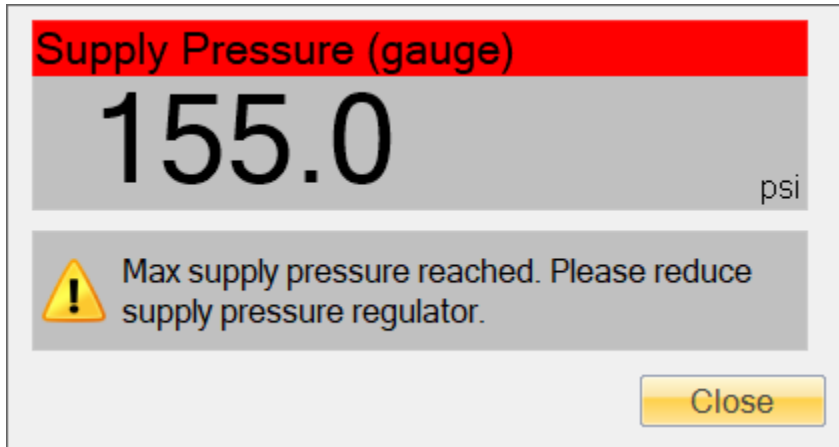

Refer to section [2.12.5 Setting Supply Pressure Regulator](#) for detailed instruction on how to set the supply pressure regulator.

4.1.6.3 Generator Calibration

The Generator Calibration command opens the Calibration Wizard dialog for calibration of the Model 2900 Humidity generator's temperature probes, pressure transducers and mass flow meter. ControLog will request a password to access the calibration functionality since it will affect the accuracy and possibly the operation of the generator if incorrectly performed. The passwords are located on the yellow product key flyer delivered with the generator.

For more information, refer to section [6 Calibration](#)

4.1.6.4 System Parameters

The System Parameter command opens the System Parameter Wizard dialog to allow adjustment of the generator's system parameters that pertain to operation, control, limits and etc. The User tab is accessible with User Access Level and lets the user change things like power up setpoints, supply gas dryness and HumiCalc parameters such as molecular weight of the supply gas.

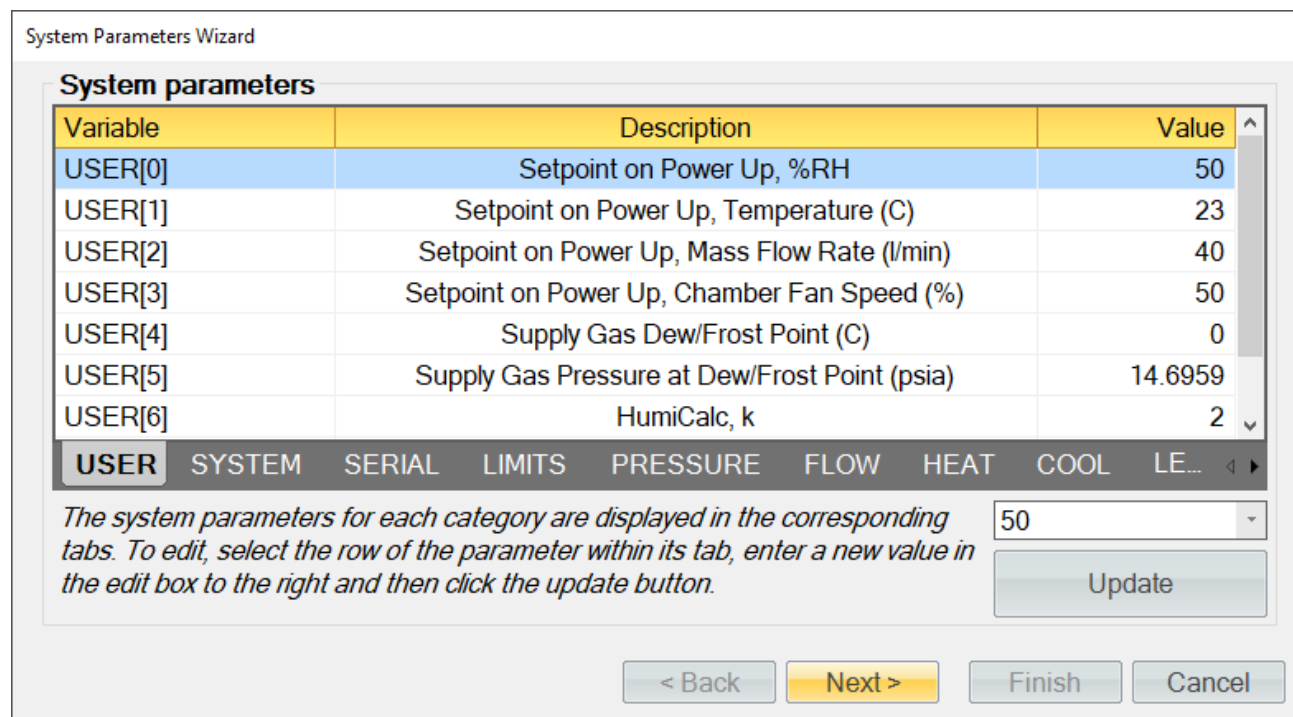

All the other tabs require Admin Access Level and changes should only be made upon request by Thunder Scientific Technical Support.

4.1.6.5 Expanded Parameters

The Expanded Parameters command opens a second tab in the Parameter Tab Group with additional generator parameters used for technical support. This tab does not need to be opened during normal operation but can be used to help diagnose problems when requesting technical support. This tab will automatically be displayed when operating the generator under the "Admin" access level.

4.1.6.6 Import Uncertainty Solution (Requires Manager Access Level or above)

The Import Uncertainty Solution file command allows a manager to import a HumiCalc with Uncertainty solution into ControLog to define the uncertainty for the Model 2900 humidity generator. Selecting this command will open an "Import Uncertainty" dialog that will step the user through the import process. Refer to your HumiCalc with Uncertainty Reference Manual for more information on creating uncertainty solutions.

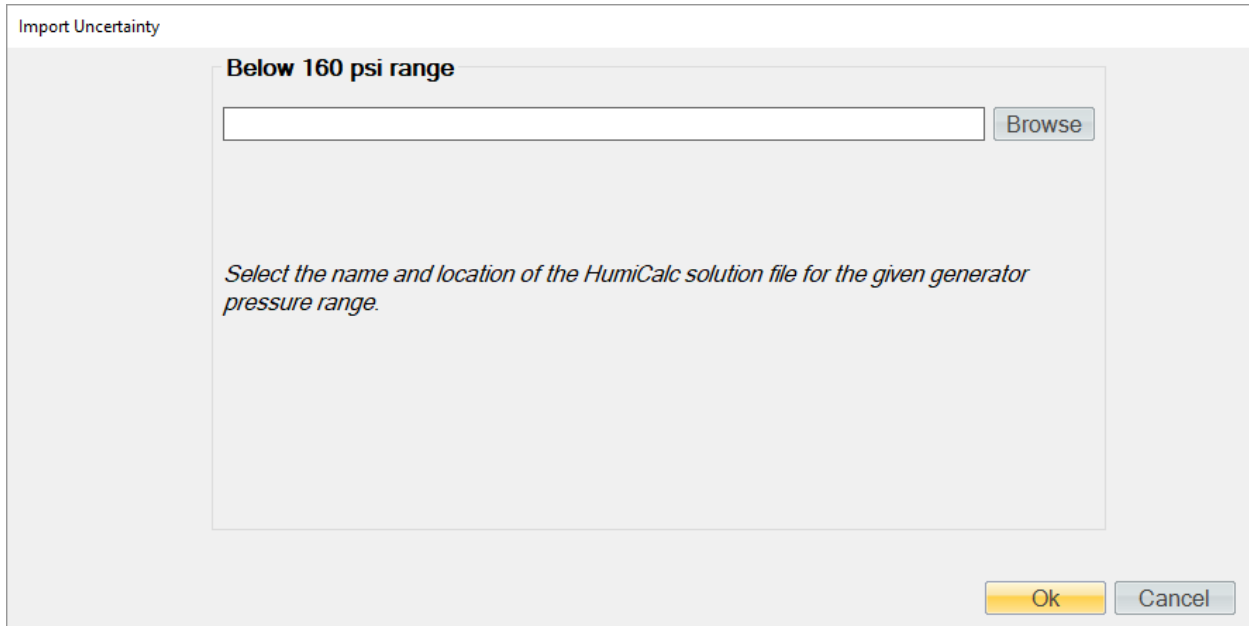

Clicking the “Browse” button will open a file dialog that will allow the user to browse to the desired location for the solution file to open. Once a file has been selected, clicking the “Ok” button will complete the import process and may display a status dialog as the solution is imported into ControLog.

4.1.6.7 *HumiCalc with Uncertainty*

The HumiCalc with Uncertainty command opens the standalone HumiCalc with Uncertainty application. It is recommended to use the USB keyboard when working with the HumiCalc with Uncertainty application.

4.1.6.8 *Access Control*

The Access Control Menu allows the user to change the access level. The user can select between User, Manager, and Admin

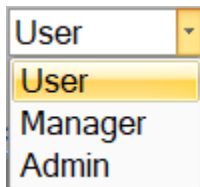

4.1.6.8.1 User Access Level

The User Access Level is default level and allows the user to run the generator, calibrate the generator, but does not give access to change system parameters, edit calibration coefficients or open interface console. No password is required for this level

4.1.6.8.2 Manager Access Level

The Manager Access Level is one level above the user level and allows the user to run the generator, calibrate the generator, edit calibration coefficients but does not give access to change system parameters or open interface console. A password is required for this level.

4.1.6.8.3 Admin Access Level

The Admin Access Level gives the user full access to run the generator, calibrate the generator, edit calibration coefficients, change system parameters and open interface console. This level is intended for factory support and should not be used regularly by the user of the 2900. A password is required for this level.

4.1.7 Graph Menu Tab

The Graph Menu Tab allows the user to create a New graph, Save, Close, Zoom, Scale, Auto Scale and set the Properties for the selected graph. The graph menu tab is part of the selection group which changes based on what data, graph or parameter tab is selected. The Graph Menu Tab will only operate on the currently selected graph tab.

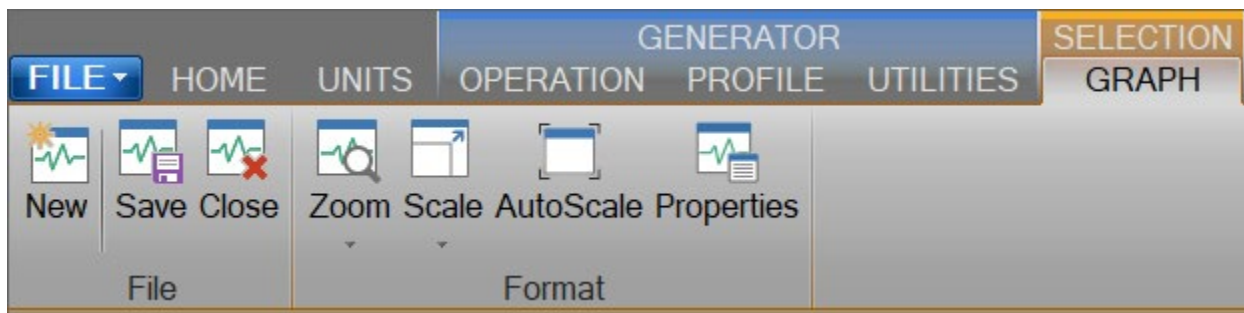

For more information, refer to section [7 Graphing](#).

4.1.7.1 New Graph

The New graph command allows the user to create a new graph. Selecting this command will open a New Graph Wizard dialog that will step the user through the selection process of what data the user would like to include in the new graph. This operation is always available.

4.1.7.2 Save Graph

The Save graph command allows the user to save the selected graph. Selecting this command will open a save file dialog that will allow the user to specify the name and browse to the desired location to save the file. ControLog graphs can be saved in following graphic file types:

- Bitmap (*.bmp)
- Graphics Interchange Format (*.gif)
- Joint Photographic Experts Group (*.jpg)
- W3C Portable Network Graphics (*.png)
- EMF Enhanced Metafile Format (*.emf)

4.1.7.3 Close Graph

The Close graph command allows the user to close the selected graph. Selection will result in a confirmation message to assure the user wants to close the graph.

4.1.7.4 Zoom Graph

The Zoom graph command allows the user to zoom a rectangular area of the graph. Selecting this command allows the user to create a rectangular area on the graph that will be zoomed.

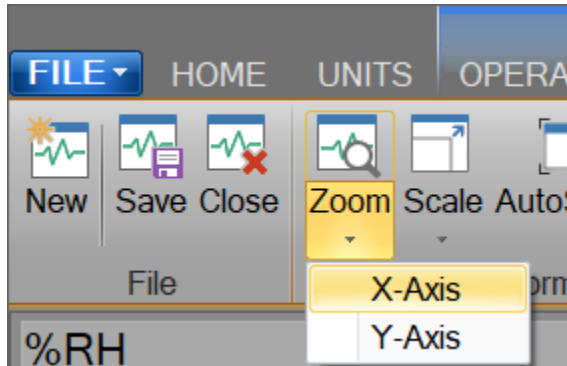

4.1.7.4.1 Zoom Graph's X Axis

The Zoom X Axis graph command allows the user to zoom along the X Axis of the graph. Selecting this command allows the user to create a sectioned area on the graph that will be zoomed along the X Axis.

4.1.7.4.2 Zoom Graph's Y Axis

The Zoom Y Axis graph command allows the user to zoom along the Y Axis of the graph. Selecting this command allows the user to create a sectioned area on the graph that will be zoomed along the Y Axis.

4.1.7.5 Scale Graph

The Scale graph command allows the user to scale both the X and Y axis. Selecting this command allows the user to use the scale using a touch or mouse gesture. Dragging the cursor up, scales the display in (zooms in) and dragging the cursor down, scales the display out (zoom out).

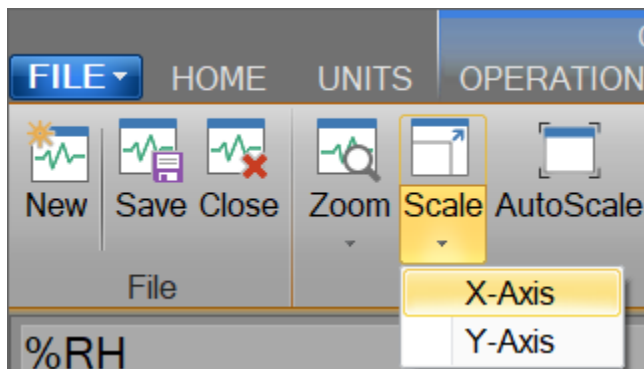

4.1.7.5.1 Scale Graph X-Axis

The Scale X-Axis graph command allows the user to scale the X axis. Selecting this command allows the user to use the scale using a touch or mouse gesture. Dragging the cursor up scales the X-Axis in (zooms X-Axis in) and dragging the cursor down scales the X Axis out (zooms X-Axis out).

4.1.7.5.2 Scale Graph Y-Axis

The Scale Y-Axis graph command allows the user to scale the Y axis. Selecting this command allows the user to use the scale using a touch or mouse gesture. Dragging the cursor up scales the Y-Axis in (zooms Y-Axis in) and dragging the cursor down scales the Y Axis out (zooms Y-Axis out).

4.1.7.6 Auto Scale

The Auto Scale graph command allows the user to reset the graph view to encompass all data. Selecting this command will automatically reset both axis of the graph so that the entire data set of each item is contained within the boundaries of the graph.

4.1.7.7 Graph Properties

The Graph Properties graph menu command allows the user to modify the properties of the selected graph. Selecting this command opens the Graph Properties dialog that allows the user to make changes to what data is graphed, the display properties for each line and the axis values.

4.1.8 Data Menu Tab

The Data Menu Tab allows the user to Save, Clear, Close, Select, Copy, Create and change the Storage Interval. The data menu tab is part of the selection group which changes based on what data, graph or parameter tab is selected. The Data Menu Tab will only operate on the currently selected data tab.

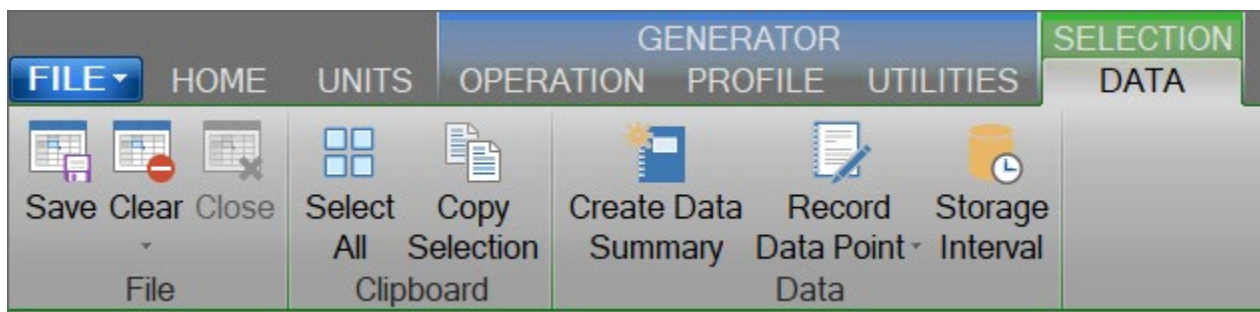

For more information, refer to section [8 Data and Data Summary](#)

4.1.8.1 Save Data

The Save data command allows the user to save the selected data tab. Selecting this command will open a save file dialog that will allow the user to specify the name and browse to the desired location to save the file. ControLog can save data in the following type and format:

- Comma-Separated Values (*.csv)
- Text File (Comma Delimited) (*.txt)
- Text File (Tab Delimited) (*.txt)
- Excel Workbook (*.xlsx)
- Excel 97-2003 Workbook (*.xls)

4.1.8.2 Clear Data

The Clear data command allows the user to clear the selected data tab. ControLog will ask the user to save any unsaved data tab before the tab is cleared. This operation is available only when at least one data point has been recorded in the selected data tab.

4.1.8.3 Close Data

The Close data command allows the user to close the selected data tab. ControLog will ask the user to confirm before closing the tab and any unsaved data tab will also prompt the user to save the data before the tab is closed. This operation is available only when the device for the selected data tab is disconnected.

4.1.8.4 Select All Data

The Select All data command allows the user to select all the data within a data tab.

4.1.8.5 Copy Selection

The Copy Selection command allows the user to copy the selected data within a data tab to the clipboard. Selecting this command will copy the selected data within a data tab to the clipboard in a tab delimited format. This data may then be pasted into another program.

4.1.8.6 Create Data Summary

The Create Data Summary data command allows the user to create a summary of any currently opened data. The feature lets the user specify what items from which device and at what intervals to include in the data summary. The data summary can also calculate error between the specified standard and the device under test. This operation is available whenever there is an open Data tab that contains data.

For more information, refer to section [8 Data and Data Summary](#)

4.1.8.7 Record Data Point

The Record Data Point data command is the same as the one on the Home tab. It allows the user to record certain data items from any currently connected device either manually, with each manual device entry or at the completion of each soak phase in an auto profile. The user can specify the number of prior data points to include and has the option to automatically calculate average and or standard deviation of the prior data points. There are two submenus for this menu command; Settings and Take Point. This operation is available whenever device or generator data is being logged. The user can manually take a point using the button or by using the keyboard shortcut "Ctrl-P".

If the user has not configured the system to record data points, then ControLog will ask the user if they would like to define the settings before taking a point.

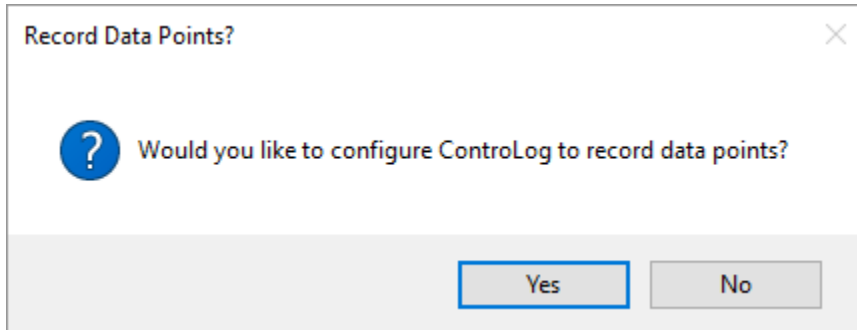

4.1.8.7.1 Settings

The Settings submenu allows the user to define which data items and from which connected device they would like to record when a point is taken. They can also define the number of points prior to include and whether to calculate average and or standard deviation. The user can also configure when to take points, either manually, at the end of a profile soak phase or when a manual device entry is taken.

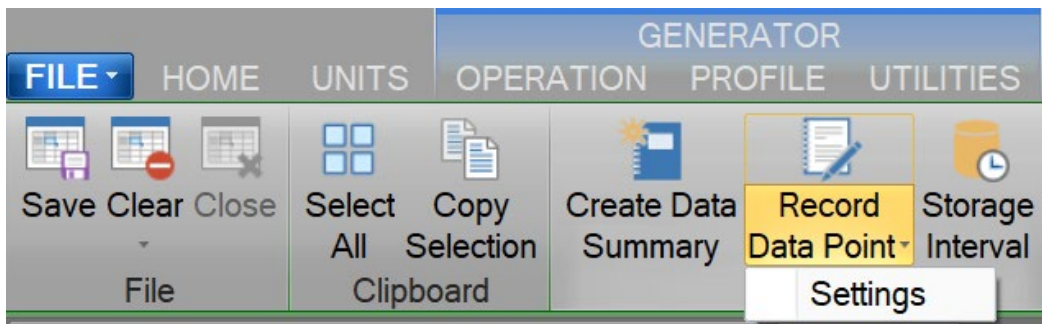

For more information, refer to section [8 Data and Data Summary](#)

4.1.8.8 Data Storage Interval

The Data Storage Interval data command allows the user to change the storage interval that data is recorded. This is the rate at which data is recorded to the data tabs for all connected devices. Selecting this command will open the "Data Storage Interval" dialog that will allow the user to change the data storage interval during the generate operation. If the "Set as Default" is checked, the new value will become the default start up interval. If not checked, the new value will only affect the current session.

IMPORTANT!

STORING AND MAINTAINING DATA CAN BECOME A TIME-CONSUMING PROCESS. THE MORE DATA THAT IS STORED IN THE DATA TAB, THE SLOWER AND LESS RESPONSIVE THE COMPUTER MAY SEEM. FOR THIS REASON, SOME CONSIDERATION SHOULD BE GIVEN TO THE AMOUNT OF DATA DESIRED, THE OVERALL TIME SPAN OF THE DATA (I.E. HOURS, DAYS, POSSIBLY WEEKS), AND ULTIMATELY THE DATA INTERVAL.

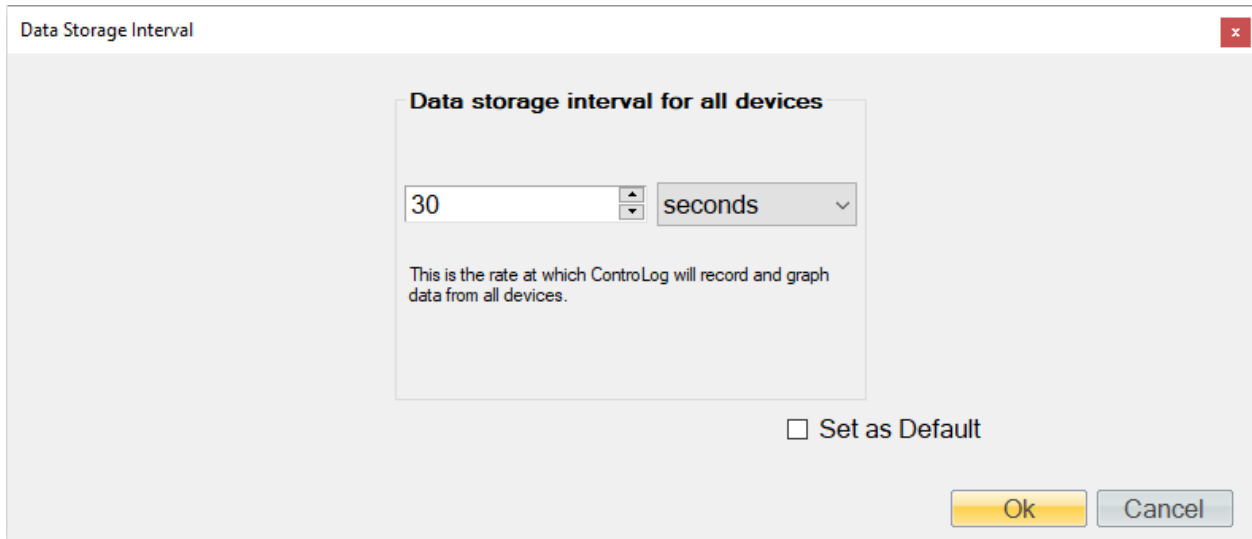

Note - Data is only recorded while the 2900 is in generate mode. Data is also stored at the generate rate whenever a device is connected and the 2900 is not connected. This gives the user the ability to use ControlLog as a logging application for any device they can connect without the need of a Model 2900 Humidity generator.

4.1.9 Device Settings Menu Tab

The Settings Menu Tab allows the user to change the settings of a device connection, disconnect a device connection and open an interface console to view communication with a device.

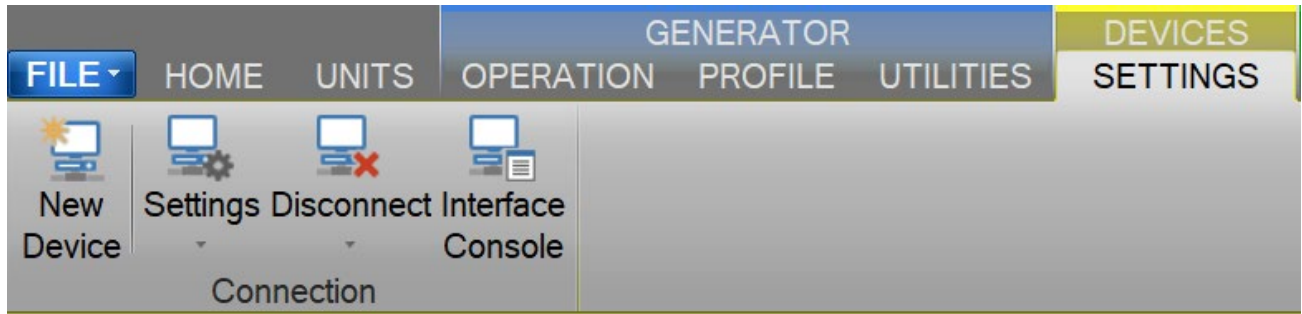

4.1.9.1 New Device

The New Device connection command allows the user to create a new device connection. Selecting this command will open a Connection Wizard dialog that will step the user through the process of creating a new connection to a device.

For more information, refer to section [10 Connections](#)

4.1.9.2 Settings

The Settings connection menu command allows the user to change the settings for a specific connection. Selecting this command will open the Connection Wizard dialog for the selected connection, allowing the user to change connection settings as desired.

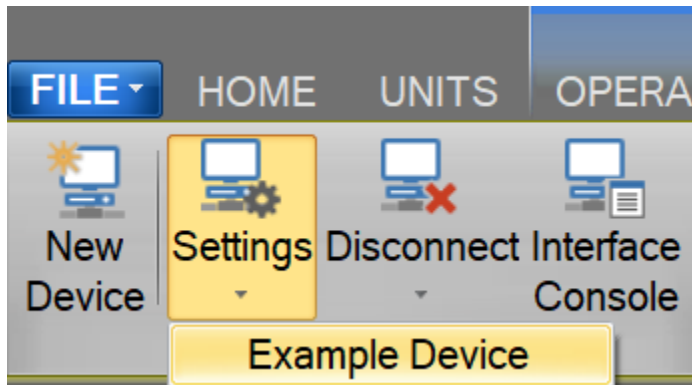

4.1.9.3 Disconnect

The Close connection menu command allows the user to close a specific connection. ControLog will ask the user to confirm before closing the connection.

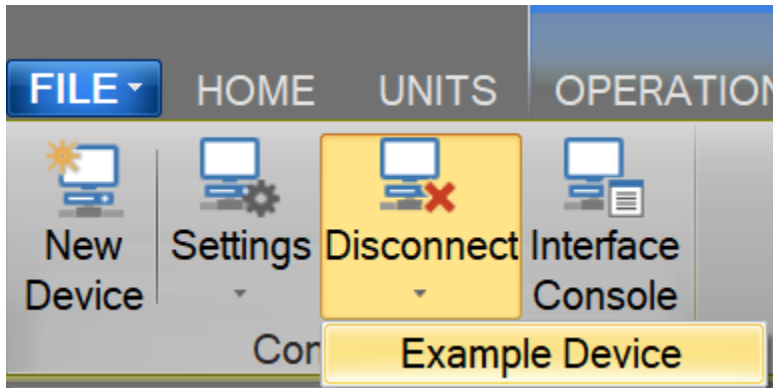

4.1.9.4 Interface Console

The Open Device Interface Console connection menu command under Settings allows the user to open a device console tab. The device console tab allows the user to view the commands being sent to and received from any given connected device.

The user can select which connected device to view using the drop-down selection at the top of the tab.

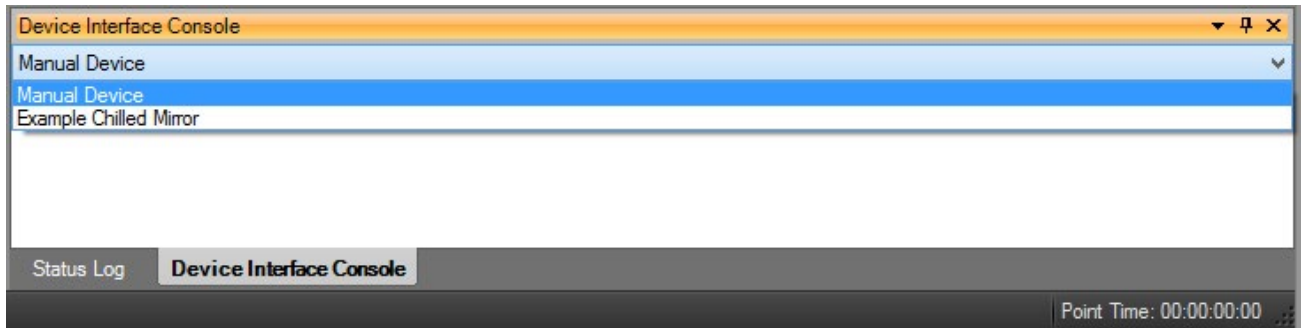

The data sent to and received from the selected device is displayed in the lower text area of the console tab.

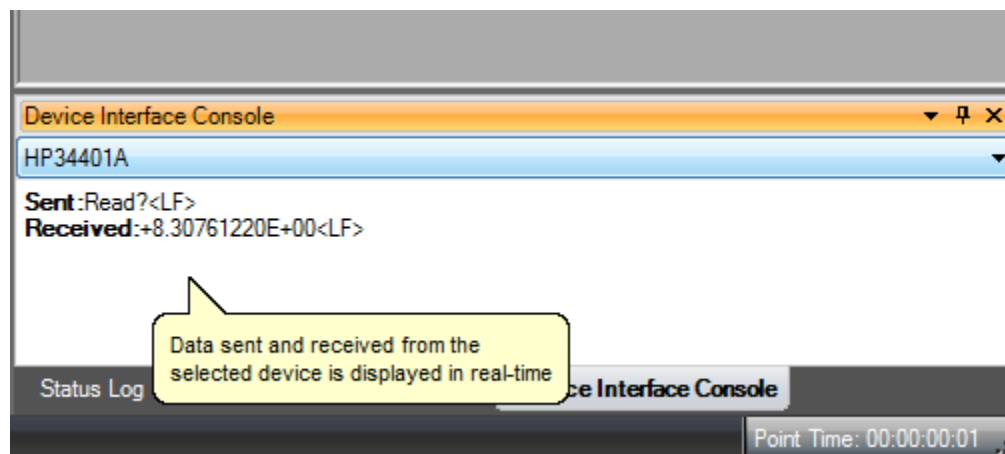

4.1.10 Help

The Help Menu located on the right side of the ribbon menu, allows the user to open the 2900 System Manual (this document).

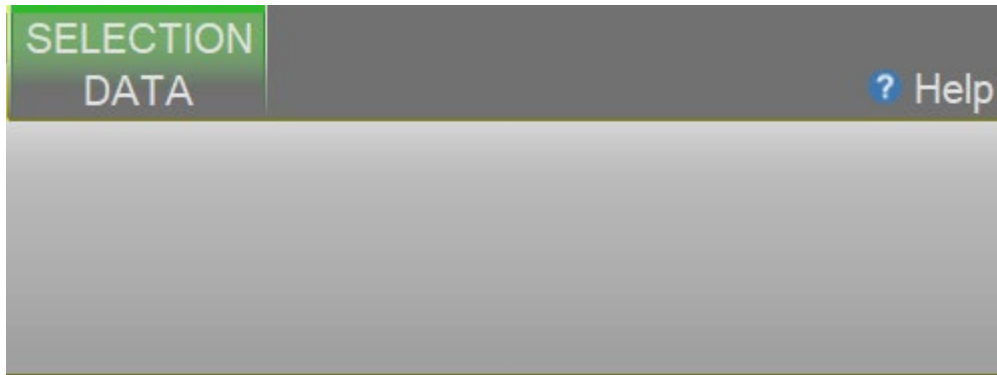

Note – Refer to the Thunder Scientific website (www.thunderscientific.com) for the latest manual edition and other information on your Model 2900 Humidity System.

4.2 PARAMETERS TAB GROUP

The Parameter Tab Group is located on the left side of the application and contains a parameter tab for each connected device. Each parameter tab displays the current data for its device and a parameter tab can be selected using the scroll bar at the bottom of the group.

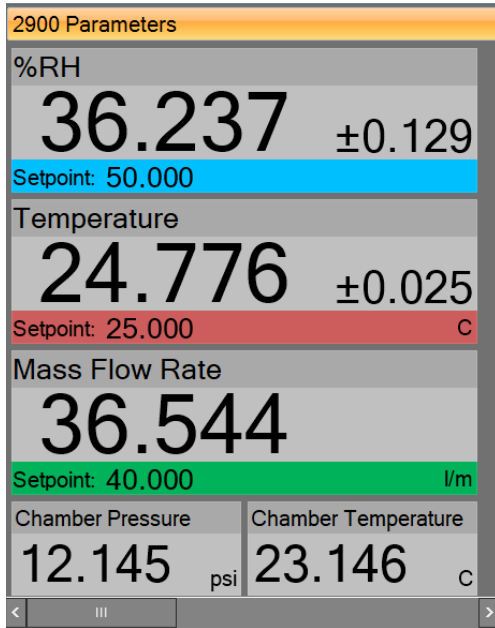

If multiple parameter tabs are open the user can accessed other tabs using the scroll bar at the bottom of the group.

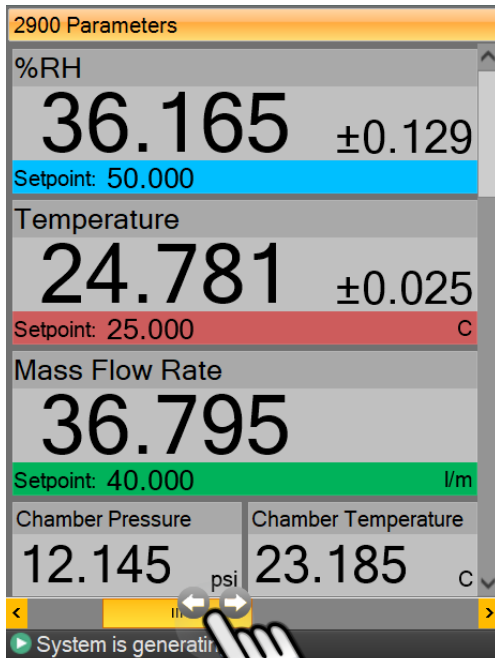

All Device Parameter Tabs have a context menu that can be displayed by long pressing the tab title area or by right clicking in the tab area. The context menu allows quick access to the device related functions that are available in the Settings Menu Tab.

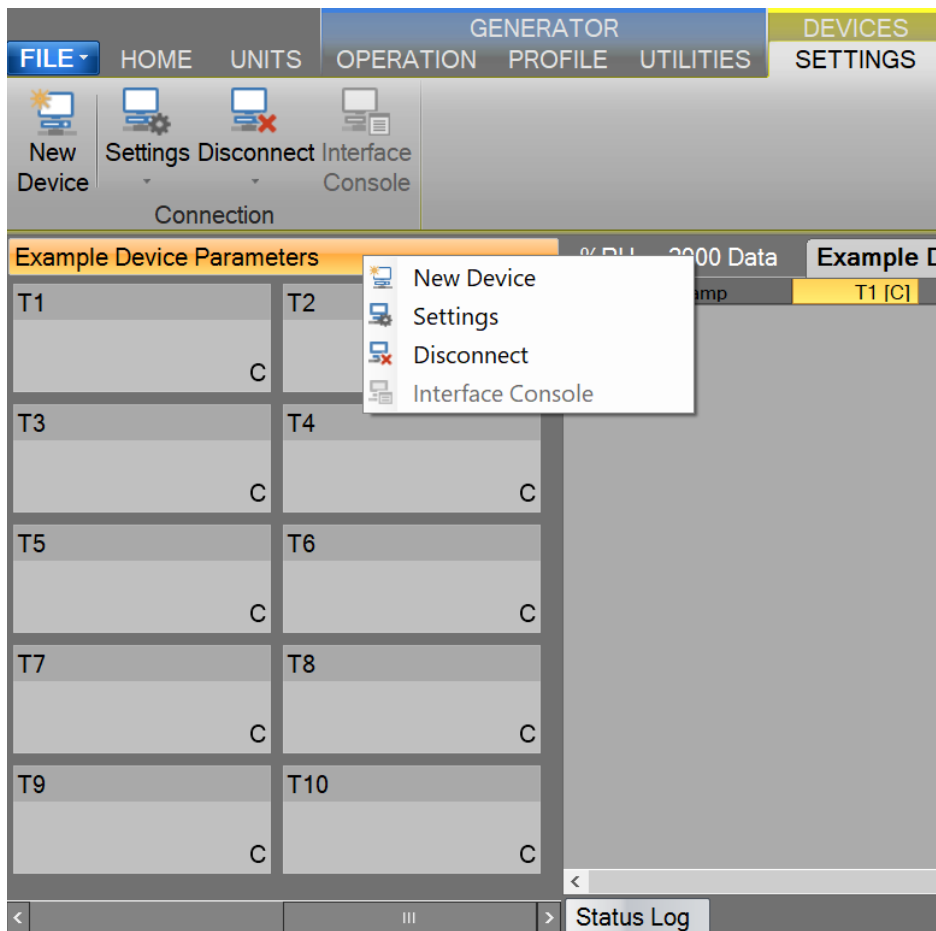

4.2.1 Tiles

Within each parameter tab area are tiles that allow the user to set setpoints, view actual values, and view real-time uncertainty values. There are two different tiles; a Setpoint Tile and a Value Tile.

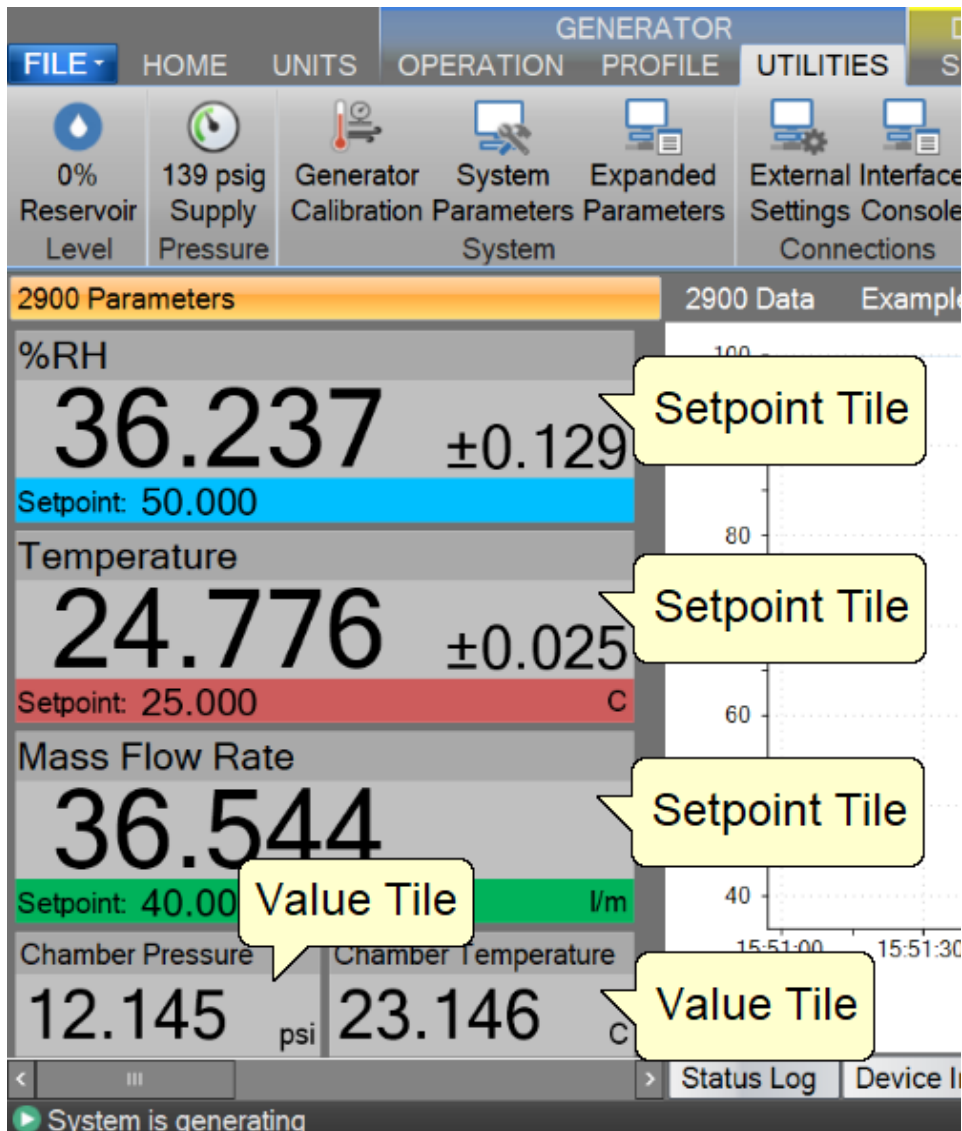

4.2.1.1.1 Setpoint Tile

The Setpoint Tiles allow the user to control the operation of the humidity generator by changing the desired setpoint that the generator will control to. The Tiles contain 5 key parts; a header with the Parameter Name, the Actual Value, the real-time Uncertainty Value, the Setpoint Value and the Unit the values are displayed in. Each setpoint tile has a colored bar to allow quick indication of the what the tile is displaying and in turn what the system is controlling. Blue is for the humidity that is being generated, red is for the temperature that the system is controlling to and green is for the flow rate the system is generating at.

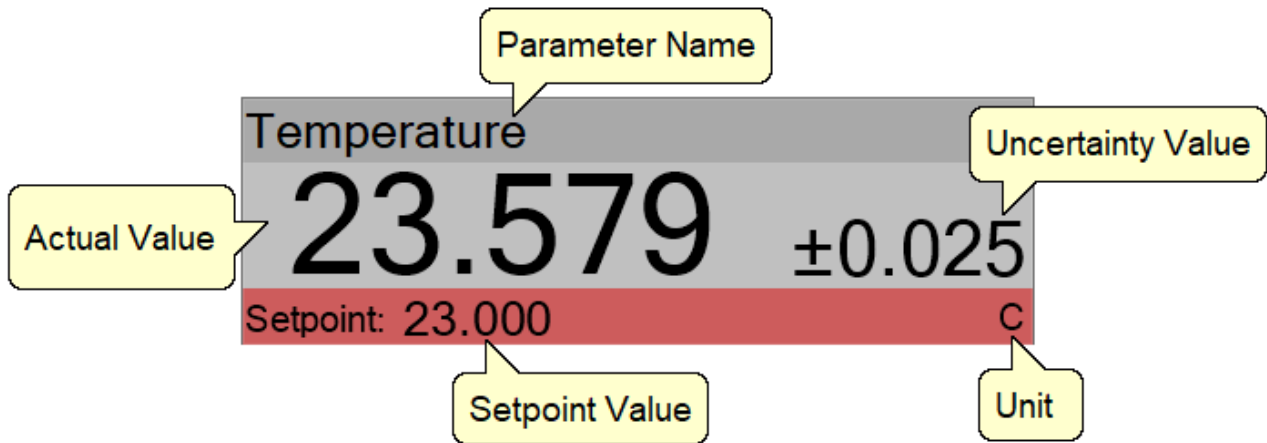

4.2.1.1.1.1 Changing Setpoints

To change a setpoint, click on the setpoint tile that you would like to change. A setpoint entry box will appear. For example, to change the Percent Relative Humidity setpoint click on the %RH setpoint tile.

The screenshot shows a dialog box titled 'Enter Setpoint Value'. Inside the dialog, there is a prompt: 'Enter the %RH you would like to generate.' Below the prompt is a text input field with a drop-down arrow on the right side. At the bottom right of the dialog are two buttons: 'Ok' and 'Cancel'.

Enter the new value into the Setpoint Entry box and select Ok. Notice that the Percent Relative Humidity setpoint value updates to the new value and the actual values begin moving toward the new setpoint.

The user can also pop-up a mini version of HumiCalc to help calculate the desired setpoint by clicking the drop-down arrow on the setpoint entry box.

For example, let's say the user wants to calculate the lowest %RH achievable given a limited supply pressure of only 100 psi.

Start by opening the HumiCalc pop-up using the drop-down arrow at the right of the setpoint entry box.

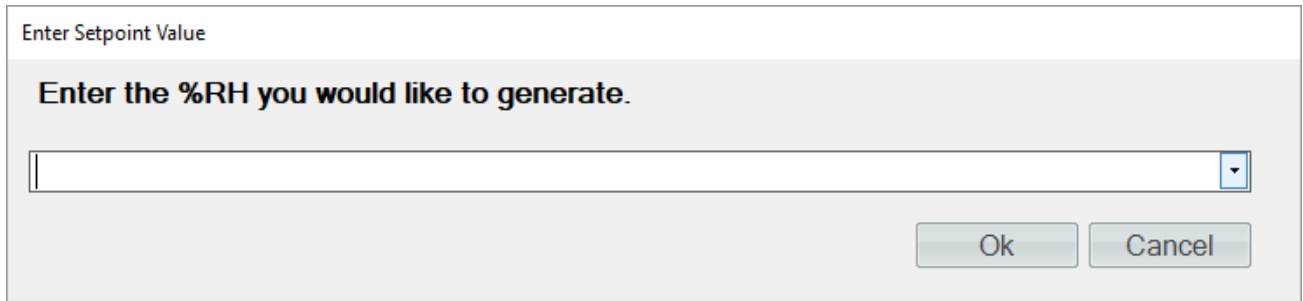

Enter Setpoint Value

Enter the %RH you would like to generate.

Ok Cancel

Next, select the known to be Saturation Pressure and enter the 100-psi supply pressure max.

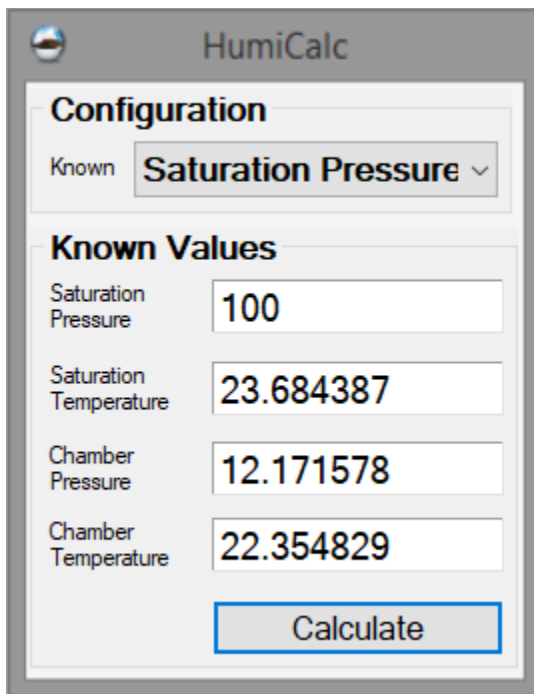

HumiCalc

Configuration

Known Saturation Pressure

Known Values

Saturation Pressure 100

Saturation Temperature 23.684387

Chamber Pressure 12.171578

Chamber Temperature 22.354829

Calculate

Clicking the “Calculate” button will result in the calculated %RH based on the 100 psi limit being placed in the Setpoint Entry Box and will close the HumiCalc pop-up.

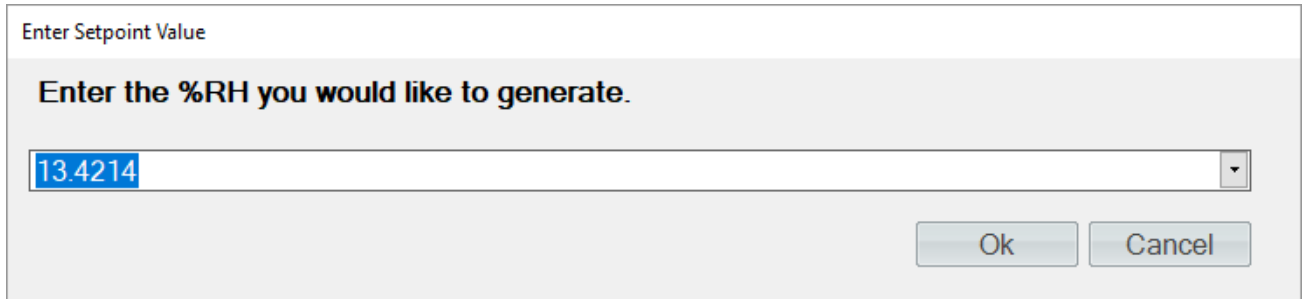

Clicking “Ok” will close the setpoint entry and will send the setpoint to the Model 2900 Humidity generator.

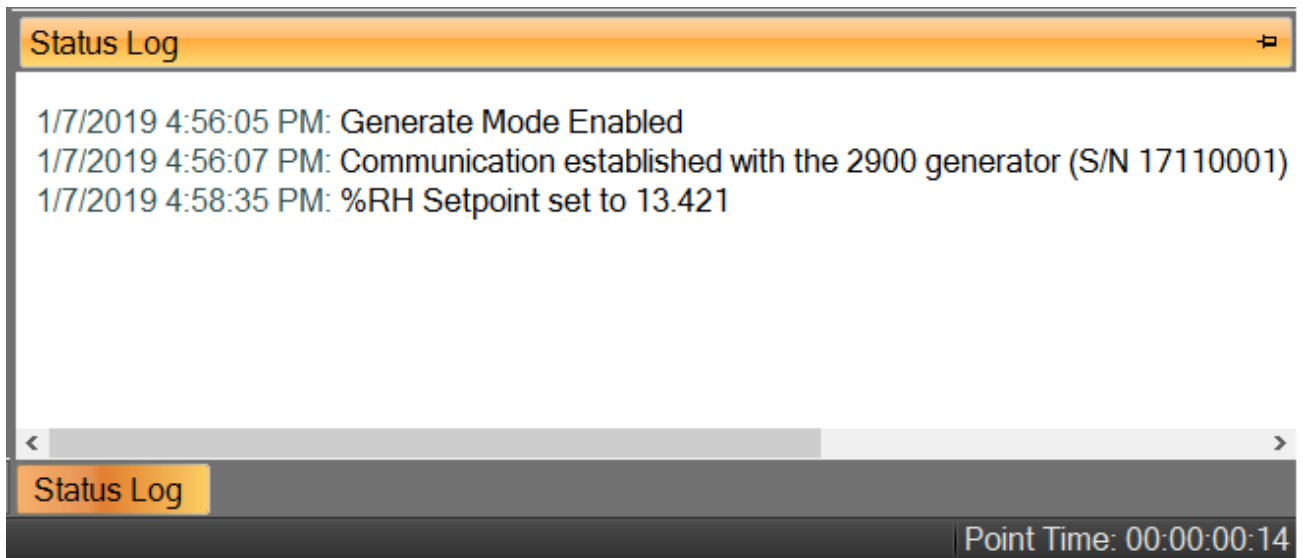

4.2.1.1.2 Value Tile

The Value Tiles display an actual value of a given parameter to the user. The Tiles contain 3 key parts; a header with the Parameter Name, the Actual Value and the Unit the value is displayed in.

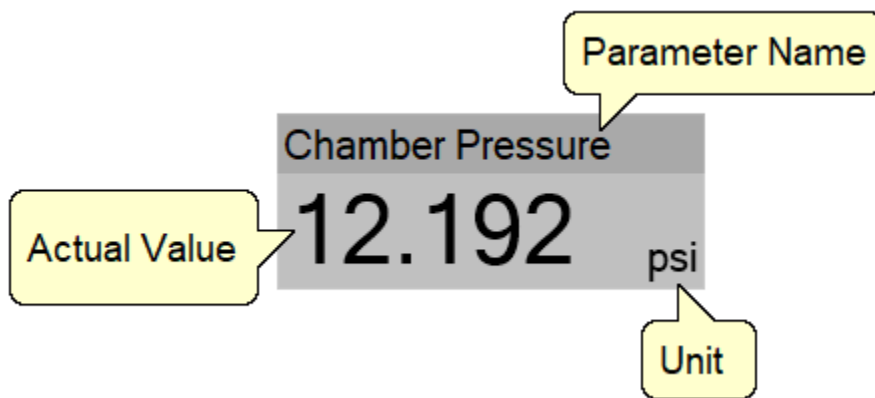

4.2.2 2900 Parameter Tab

The 2900 Parameters contain all the control and measurement parameters critical to the operation of the humidity generator.

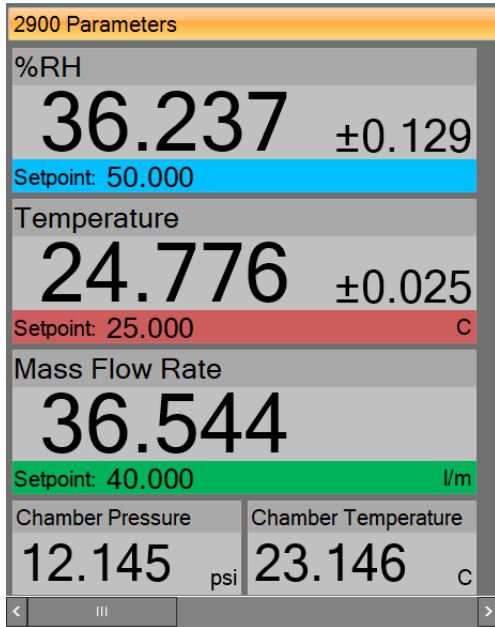

The 2900 Parameters can be scrolled up and down to show the currently generated humidity in different humidity terms that are calculated using the HumiCalc with Uncertainty engine, along with other values that are important to the operation of the 2900 generator.

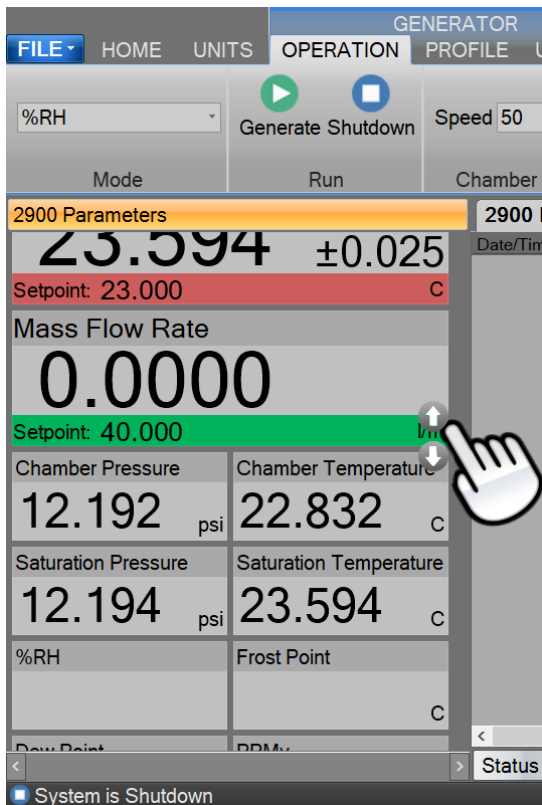

4.2.2.1 *Actively Controlled Humidity*

The first tile on the Control Parameters is the actively controlled humidity parameter. For instance, if ControLog were set to control the generator on dew point, then Dew Point would be listed as the first parameter rather than %RH.

This setpoint controls the humidity being generated.

4.2.2.2 *Saturation Pressure*

The Saturation Pressure is the pressure reading of the saturator pressure transducer (T2).

For more information, refer to section [3 Principle of Operation](#)

4.2.2.3 *Chamber Pressure*

Chamber Pressure is the pressure reading of the chamber pressure transducer (T3).

For more information, refer to section [3 Principle of Operation](#)

4.2.2.4 *Temperature*

Temperature is the temperature reading of the saturator temperature probe (RTD1) which is a direct indication of the fluid system temperature.

This setpoint controls the fluid system temperature within the system while generating.

4.2.2.5 *Saturation Temperature*

Saturation Temperature is the temperature reading of the saturator temperature probe (RTD1).

For more information, refer to section [3 Principle of Operation](#)

Note - The 2900 can only operate for a finite amount of time at or below 0 °

4.2.2.6 *Chamber Temperature*

Chamber Temperature is the temperature reading of the chamber temperature probe (RTD4).

For more information, refer to section [3 Principle of Operation](#)

4.2.2.7 *Mass Flow Rate*

Mass Flow Rate is the mass flow reading of the flow meter (T4). This is the actual flow of the air supply entering the Pre-Saturator and is an indication of the total flow through the system once the saturation and chamber pressure have stabilized.

The Mass Flow Rate setpoint controls the mass flow rate of the system.

4.2.2.8 *%RH*

Percent Relative Humidity (%RH) is the ratio of the amount of water vapor in a given sample to the maximum amount possible at the same temperature and pressure. %RH is calculated at the chamber pressure and chamber temperature relative to the saturation pressure and saturation temperature. This is the most accurate calculation of %RH at the point in the immediate vicinity of the chamber temperature probe. Placing the chamber temperature probe at the humidity sensing point of the devices under test gives the actual value of the relative humidity being imposed on the devices, as it is dependent on both pressure and temperature.

4.2.2.9 Frost Point

Frost Point Temperature is the temperature to which a gas must be cooled in order to just begin condensing water vapor in the form of frost or ice, and therefore only exists at values below 0.01 °C. When operating the system with indicated Frost Points above 0.01 °C, the values indicated are to be interpreted as Dew Points. However, Frost Point is not the same as Dew Point for values below freezing. Frost Point is independent of test chamber temperature.

4.2.2.10 Dew Point

Dew Point Temperature is the temperature to which a gas must be cooled in order to just begin condensing water vapor in the form of dew. Generally, Dew Point exists at temperatures above freezing. In many instances, Dew Point may actually exist at indicated values below freezing (super-cooled dew). However, it is important to note that Dew Point is not the same as Frost Point. Dew Point is independent of test chamber temperature.

4.2.2.11 PPMv

Parts per Million by Volume is a ratio of the number of molecules of water vapor to the number of molecules of the other constituents in the gas. Once established, PPMv is pressure and temperature insensitive, and is therefore independent of test chamber temperature and test chamber pressure.

4.2.2.12 PPMw

Parts per Million by Weight is a ratio of the weight of the water vapor in a sample to the weight of the remaining constituents in the gas. Once established, PPMw is pressure and temperature insensitive, and is therefore independent of test chamber temperature and test chamber pressure.

4.2.2.13 Grains/lb

Grains per pound is a ratio of the weight, in grains, of water vapor to the weight, in pounds, of the other constituents in the gas. (7000 grains = 1 pound). Once established, Grains/lb is pressure and temperature insensitive, and is therefore independent of test chamber temperature and test chamber pressure.

4.2.2.14 Enthalpy

Enthalpy is a measure of the amount of energy required to change a gas from one temperature/humidity value to another. In application, enthalpy is not used as an absolute value, but rather it is the difference in enthalpy between two distinct points which are of interest. The datum point which results in zero enthalpy was therefore arbitrarily chosen at a test temperature of 0 °C and 0 %RH. Applying enthalpy is a matter of computing the difference in enthalpy between two or more distinct data points.

4.2.2.15 SVP@Tt

Saturation Vapor Pressure (SVP) computed at the Test Temperature.

4.2.2.16 SVP@Td

Saturation Vapor Pressure (SVP) computed at the Dew/Frost Point Temperature.

4.2.2.17 SVP@Ts

Saturation Vapor Pressure (SVP) computed at the Saturation Temperature.

4.2.2.18 F@Tt.Pt

Enhancement Factor at Test Temperature and Pressure.

4.2.2.19 F@Td.Pt

Enhancement Factor at Dew/Frost Point Temperature and Test Pressure.

4.2.2.20 F@Ts.Ps

Enhancement Factor at Saturation Temperature and Pressure.

4.2.2.21 Specific Humidity

Specific Humidity is a ratio of the weight of the water vapor to the total weight of the humidified gas. Specific Humidity is independent of test chamber temperature.

4.2.2.22 Absolute Humidity

Absolute Humidity is the weight of the water vapor per unit volume of humidified gas.

4.2.2.23 Dry Air Density

Dry Air Density is the *partial* density in weight per unit volume of only the dry air portion of a moist air sample. In other words, if the water vapor were removed from a fixed volume of air, the remaining dry air would exhibit this density.

4.2.2.24 Moist Air Density

Moist Air Density is the total weight per unit volume of a moist air sample. This density includes both the weight of the air and the weight of the water vapor.

4.2.2.25 Wet Bulb Temperature

Wet Bulb temperature is used in wet bulb/dry bulb aspirated Psychrometry, and is the temperature measured by a temperature probe whose tip is coated with water (typically by being covered with a wet sock). When aspirated at a constant air velocity, the wet bulb will cool due to evaporation of the water from the probe. The cool temperature, to which it equilibrates, is used in the calculation of humidity parameters.

4.2.2.26 Mixing Ratio by Volume

Mixing Ratio by Volume is a ratio of the partial pressure of the water vapor to the partial pressure of the remaining constituents in the sample. Mixing Ratio by Volume is independent of test chamber temperature.

4.2.2.27 Mixing Ratio by Weight

Mixing Ratio by Weight is a ratio of the weight of the water vapor to the weight of the remaining constituents in the sample. Mixing Ratio by Weight is independent of test chamber temperature.

4.2.2.28 Percent by Volume

Percent by Volume is a ratio (expressed as a percentage) of the partial pressure of the water vapor to the total pressure of the sample. Percent by Volume is independent of test chamber temperature.

4.2.2.29 Percent by Weight

Percent by Weight is a ratio (expressed as a percentage) of the weight of the water vapor to the total weight of the sample. Percent by Weight is independent of test chamber temperature.

4.2.2.30 Vapor Mole Fraction

Vapor Mole Fraction is the mole fraction of water vapor in a sample.

4.2.2.31 Dry Air Mole Fraction

Dry Air Mole Fraction is the mole fraction of the dry air portion of a sample. The dry air portion is considered to be all constituents in a gas exclusive of the water vapor.

4.2.2.32 Cabinet Temperature

Cabinet Temperature is the temperature reading of the cabinet temperature probe (RTD5).

4.2.2.33 Exp-Valve Temperature

The Exp-Valve Temperature is the temperature reading of the expansion valve probe (RTD3)

For more information, refer to section [3 Principle of Operation](#)

4.2.2.34 Pre-Saturator Temperature

The Pre-Saturator temperature is the temperature reading of the Pre-Saturator probe (RTD2).

For more information, refer to section [3 Principle of Operation](#)

4.2.2.35 Supply Pressure

Supply pressure is the pressure reading of the gas supply pressure transducer (T1). The supply pressure value is gauge pressure.

4.2.2.36 Water Reservoir Level

Water reservoir level (LL1, LL1P) is the liquid level reading of the water within the reservoir.

Refer to section [5.1.1 Fill Water Reservoir](#) for detailed instruction on how to fill the reservoir.

4.2.3 Device Parameter Tabs

The Device Parameter Tabs show the current actual values for the given device. The tabs are visible whenever the device is connected. The Device Parameters will display a scrollbar as needed to allow for varying display sizes without loss of data.

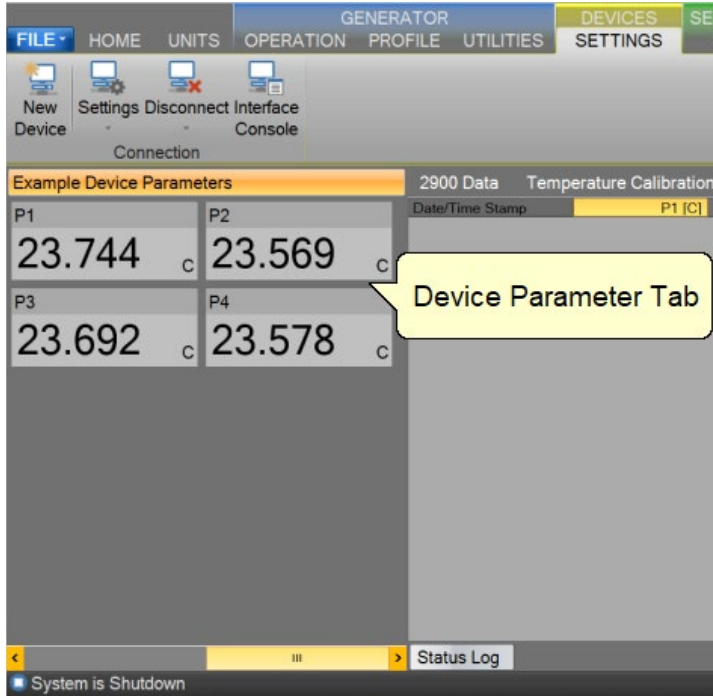

4.2.3.1 Device Parameters

Device Parameters contain all the most recent actual measurement parameters received from the device. Each parameter is displayed in a separate Value Tile.

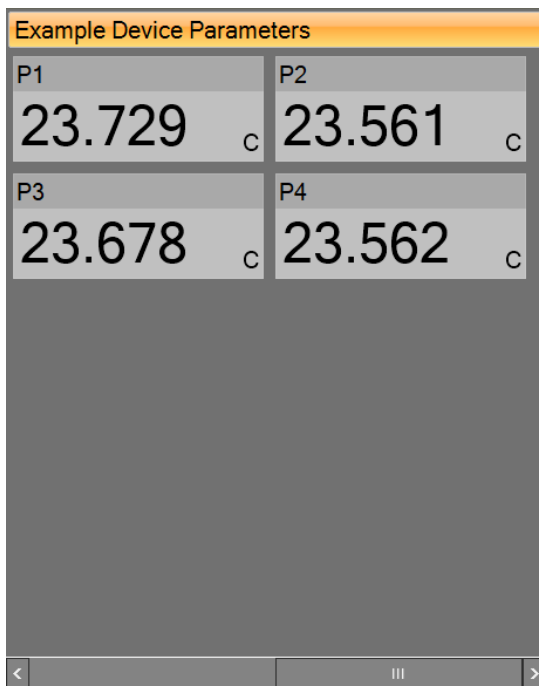

4.3 DATA AND GRAPH TAB GROUP

The Data and Graph Tab Group is located in the middle right of the application and can contain data, graph, and profile tabs. Data and Graph tabs are fixed tab style windows that can be selected by clicking the desired tab labels at the top.

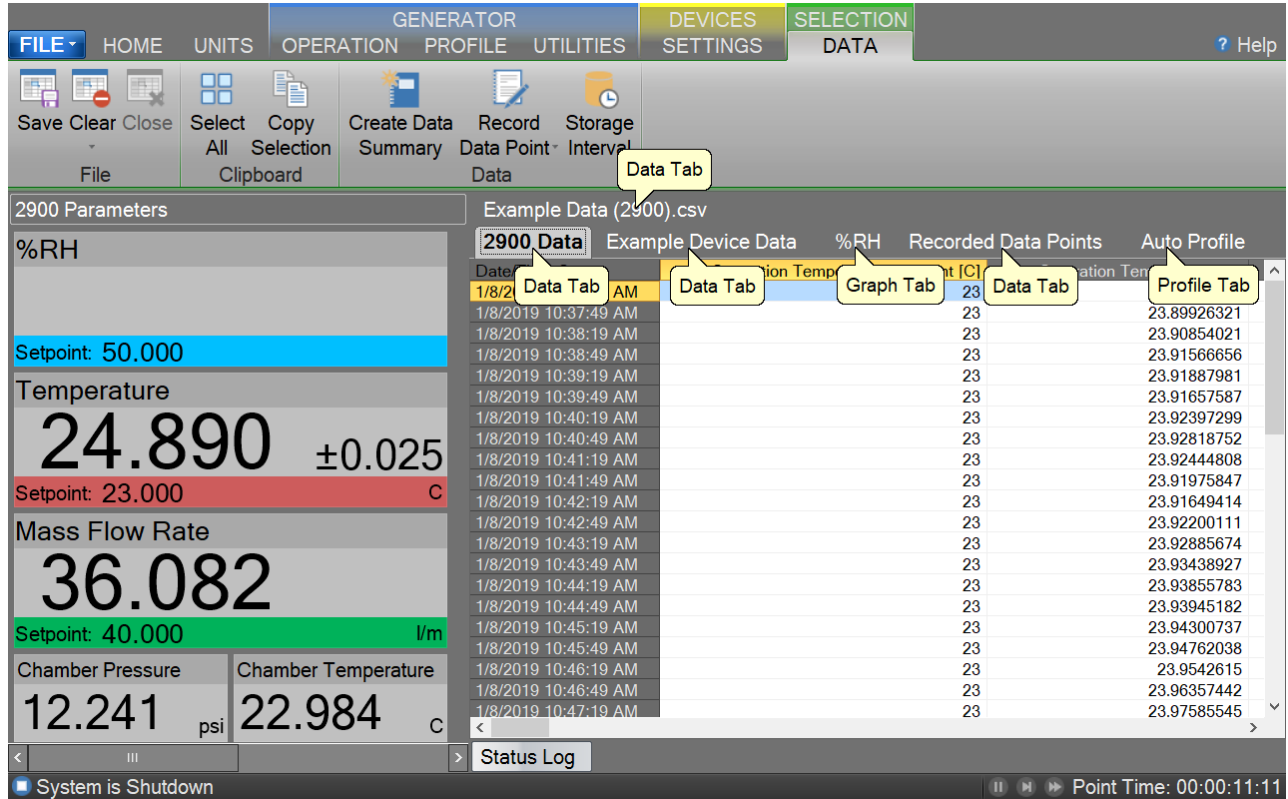

In addition to using the “Close Data” command from the ribbon menu a Data and Graph Tab can be closed depending on the state of the device or generator using the “X” in the upper right-hand corner.

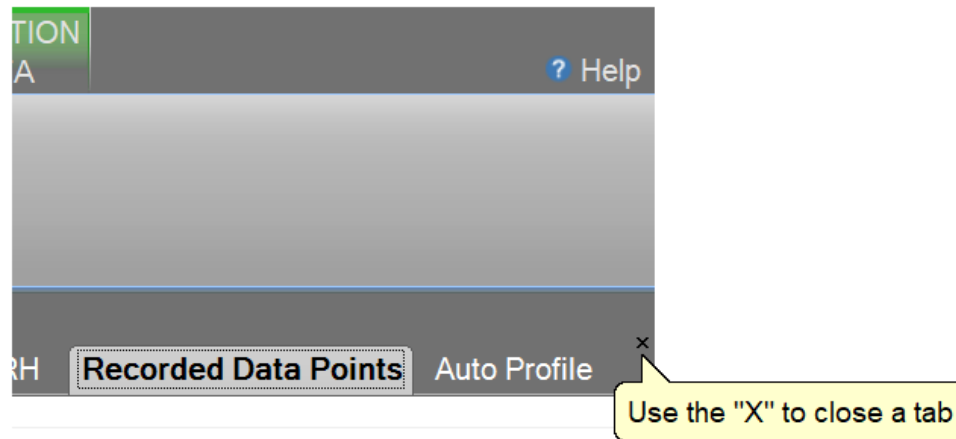

4.3.1 Data Tabs

Data Tabs contain a spreadsheet type view of the logged data.

For more information, refer to section [8 Data and Data Summary](#)

4.3.2 Graph Tabs

Graph Tabs contain a pictorial view of the logged data.

For more information, refer to section [7 Graphing](#)

4.3.3 Profile Tab

The Profile Tab contains the profile point definitions for an auto profile.

For more information, refer to section [9 Profiling](#)

4.4 INFORMATION TAB GROUP

The Information Tab Group is located on the bottom right hand side of the application. This is a docking style window that can be “pinned” open or allowed to close when not active. An information tab is selected by clicking its tab label at the bottom of the group. The Information Tab Group contains status information about the operation of the generator and its connected devices. The group can consist of a Status Log tab, 2900 Reported Errors tab and a 2900 Interface Console tab.

By clicking the pin icon on any information tab, the user can pin or unpin the Information tabs.

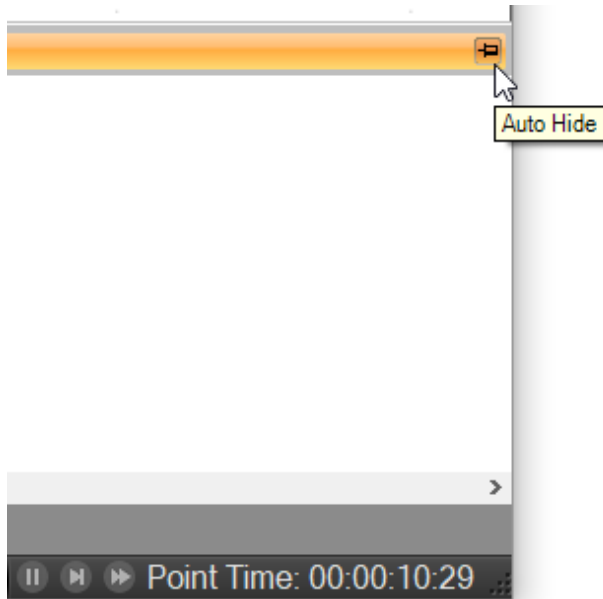

By default, the information tabs are unpinned, and they will automatically hide.

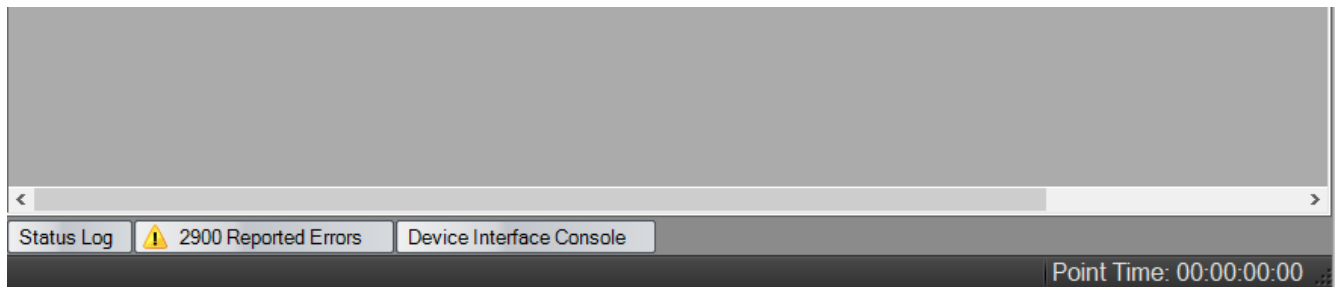

The user can access the hidden tabs by clicking the desired information tab label at the bottom.

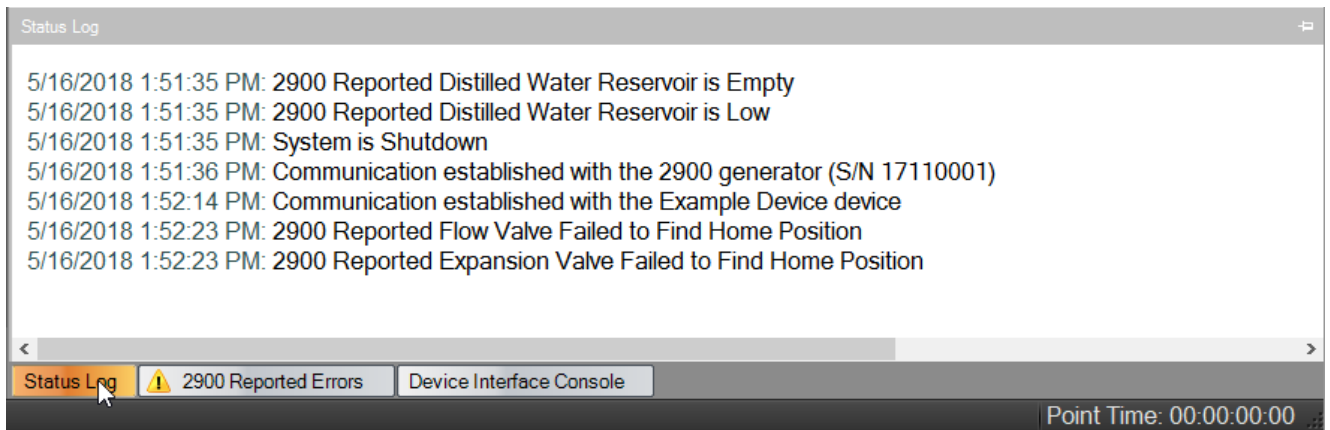

All Information Tabs have a context menu that is displayed by long pressing or right clicking in the tab. The context menu allows quick access to functions that can clear and save the information.

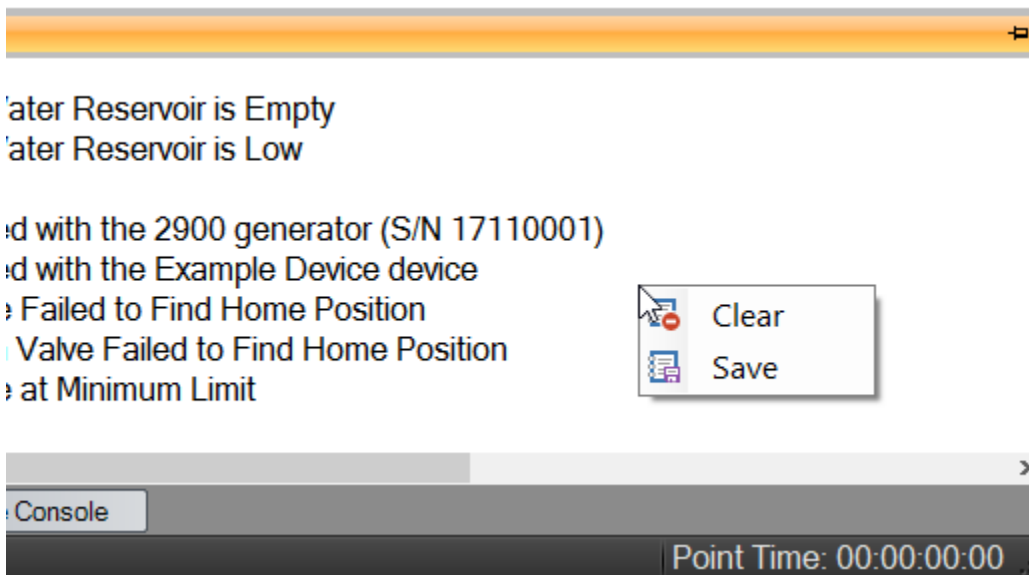

4.4.1 Status Log

The Status Log tab contains chronological information about the system status, changes in operational modes, changes in setpoints, and runtime errors due to communication or mechanical difficulties encountered by the generator.



4.4.2 2900 Reported Errors

The 2900 Reported Errors tab only appears when the 2900 reports an error. This is a very important information tab because it reports 2900 system errors to the user. These types of errors can cause the 2900 to shutdown and require immediate attention by the operator. The  icon will be displayed to help draw the attention of the user to the reported 2900 errors.

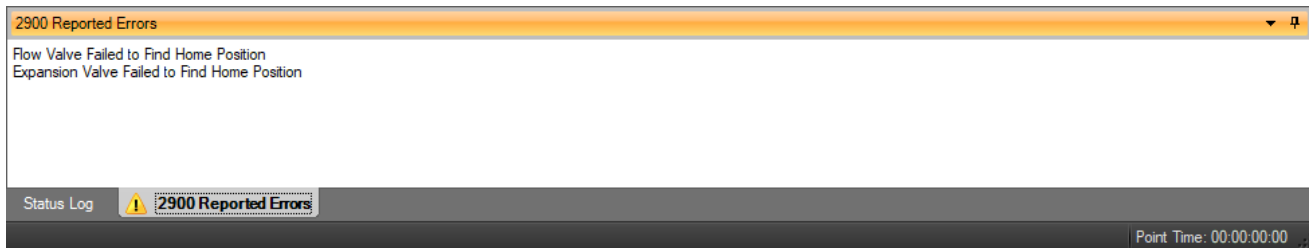

4.4.3 System timing

The System Timing tab shows information about the current timing associated with the current operation such as elapsed run time at current conditions. This window may be shown at any time by clicking the "Point Time" in the status bar and is automatically shown when an Auto Profile is started. The tab gives detailed information on the Auto Profile as it runs. Elapsed and remaining Phase, Point and Total time are listed along with the detailed assurance conditions values and tolerances.

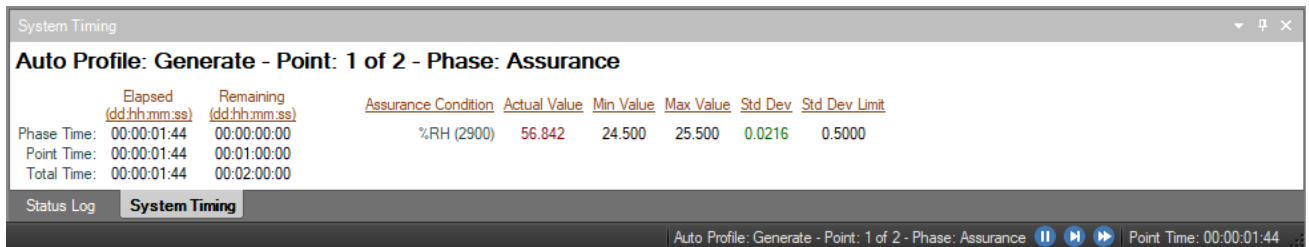

4.4.4 2900 Interface Console

The 2900 Interface Console tab allows the user to send and receive commands to and from the 2900. The console tab is opened by selecting "Interface Console" from the Utilities Menu Tab. This feature is intended for factory support and should not be used regularly by the user of the 2900.

4.4.5 Device Interface Console

The Device Interface Console tab allows the user to view the commands being sent to and received from any given connected device. The device console tab is opened by selecting “Interface Console” from the Settings Menu Tab whenever a device is connected.

The user can select which connected device to view using the drop-down selection at the top of the tab.

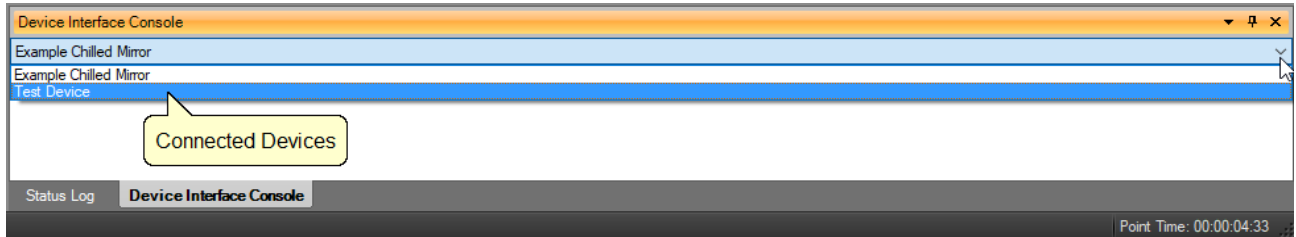

The data sent to the device is indicated by a bold “Sent:” label in the lower text area of the console tab.

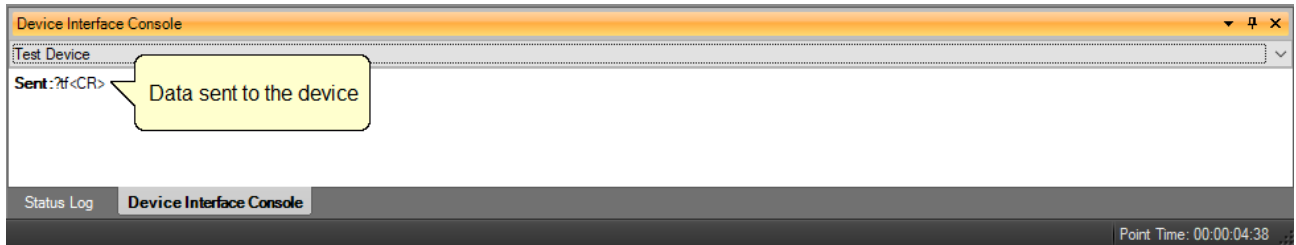

The data received from the device is indicated by a bold “Received:” label in the lower text area of the console tab.



4.5 STATUS BAR

The Status Bar is located on the bottom of the application window. The Status Bar displays the current Connection and Run Status of the generator, Auto Profile Controls and Status, and current Point Time.

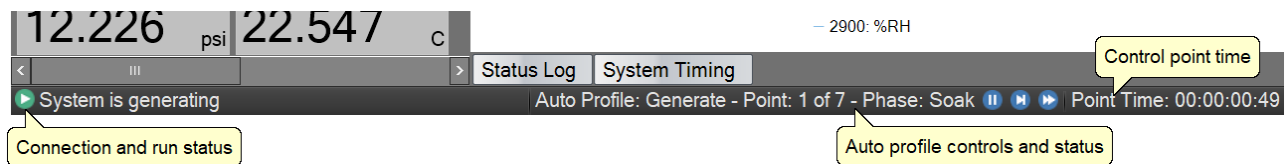

4.5.1 Connection and Run Status

The Connection and Run Status is shown on the left-hand side of the status bar and gives the user a quick visual and textual reference to the current state of the Model 2900 Humidity generator. As new events are recorded into the Status Log, the event will be displayed for a short period of time in the status bar to inform the user of the new event.

4.5.1.1 *Disconnected*

The status bar will show an “unplugged” icon and “Disconnected” when the 2900 is not connected to ControLog.

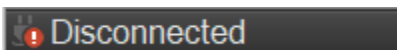

4.5.1.2 *Generating*

The status bar will show a green forward arrow icon and “System is generating” when the 2900 is generating.

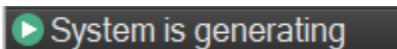

If the 2900 is reporting an error, the green forward arrow icon will also appear with a small yellow warning.

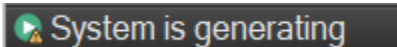

4.5.1.3 *Shutdown*

The status bar will show a blue stop icon and “System is Shutdown” when the 2900 is shutdown.

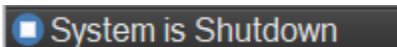

If the 2900 is reporting an error, the blue stop icon will also appear with a small yellow warning.

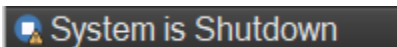

4.5.1.4 New Event

During any state, the most recent status log event will be shown briefly in the status bar.

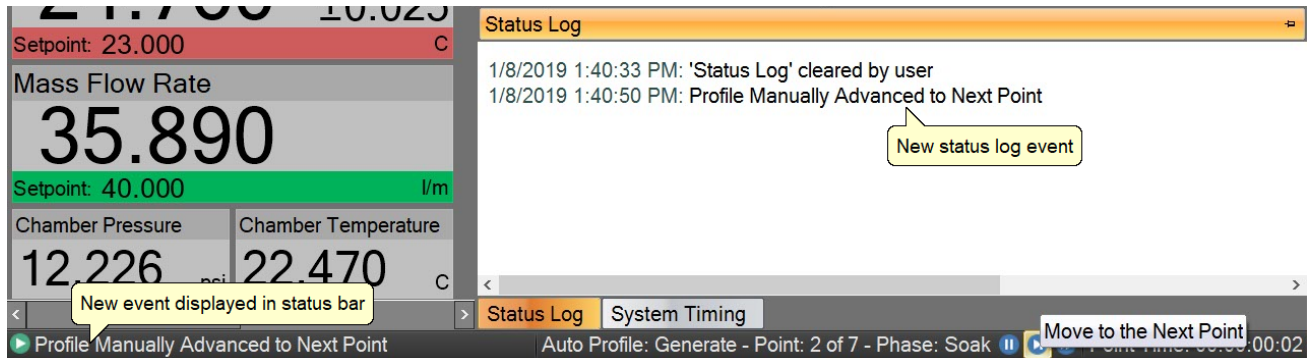

4.5.2 Auto Profile Controls and Status

The Auto Profile Controls and Status are shown on the right-hand side of the status bar and give the user quick control and status over a running profile. The Auto Profile consists of three status parts and three control parts.

For more information, refer to section [9 Auto Profiling](#)

4.5.2.1 Auto Profile Controls

The Auto Profile controls consist of a “Pause” button, “Next Point” button and a “Next Phase” button.

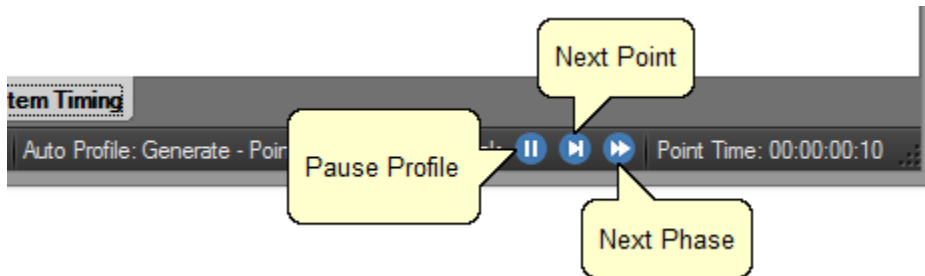

4.5.2.2 Auto Profile Status

The Auto Profile status consists of the generator “Run Mode” for the current profile point, the “Profile Point” the system is currently running and the “Phase” of the current point.

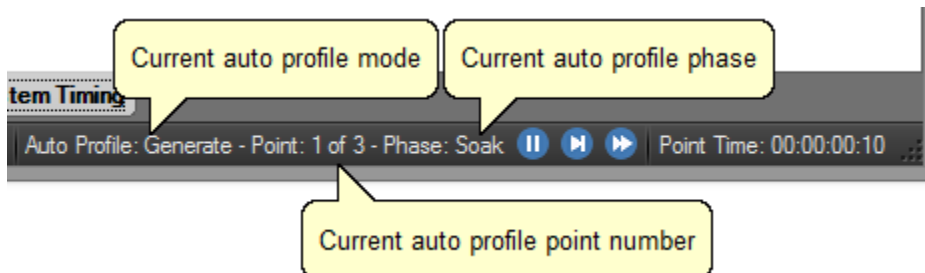

4.5.3 Current Point Time

The Current Point Time is shown on the right-hand side of the status bar and gives the user a quick display to the amount of time the system has been at point. Point Time is not the amount of time at setpoint but simply the amount of time since the last setpoint or mode change.

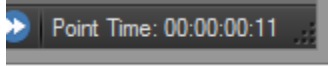

The user can click the point time to open the system timing tab.

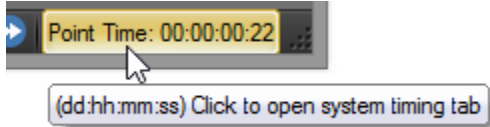

4.5.4 Set Date and Time

The user can change the current system date and time through the status bar context menu.

Note – *To avoid time stamp confusion only change the system date and time when the generator is shutdown and not recording data.*

Start by long pressing or right clicking anywhere within the status bar to open the status bar context menu.

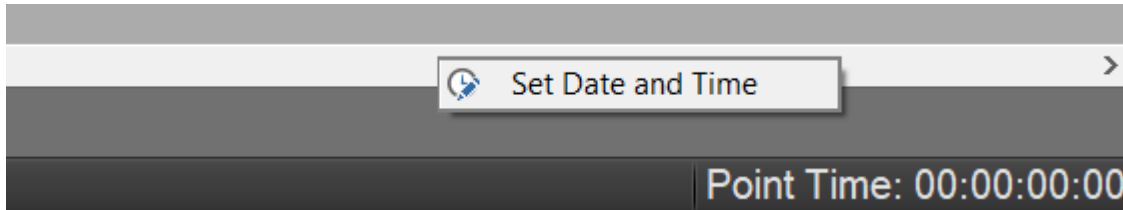

Select "Set Date and Time" from the context menu to open the system Date and Time dialog.

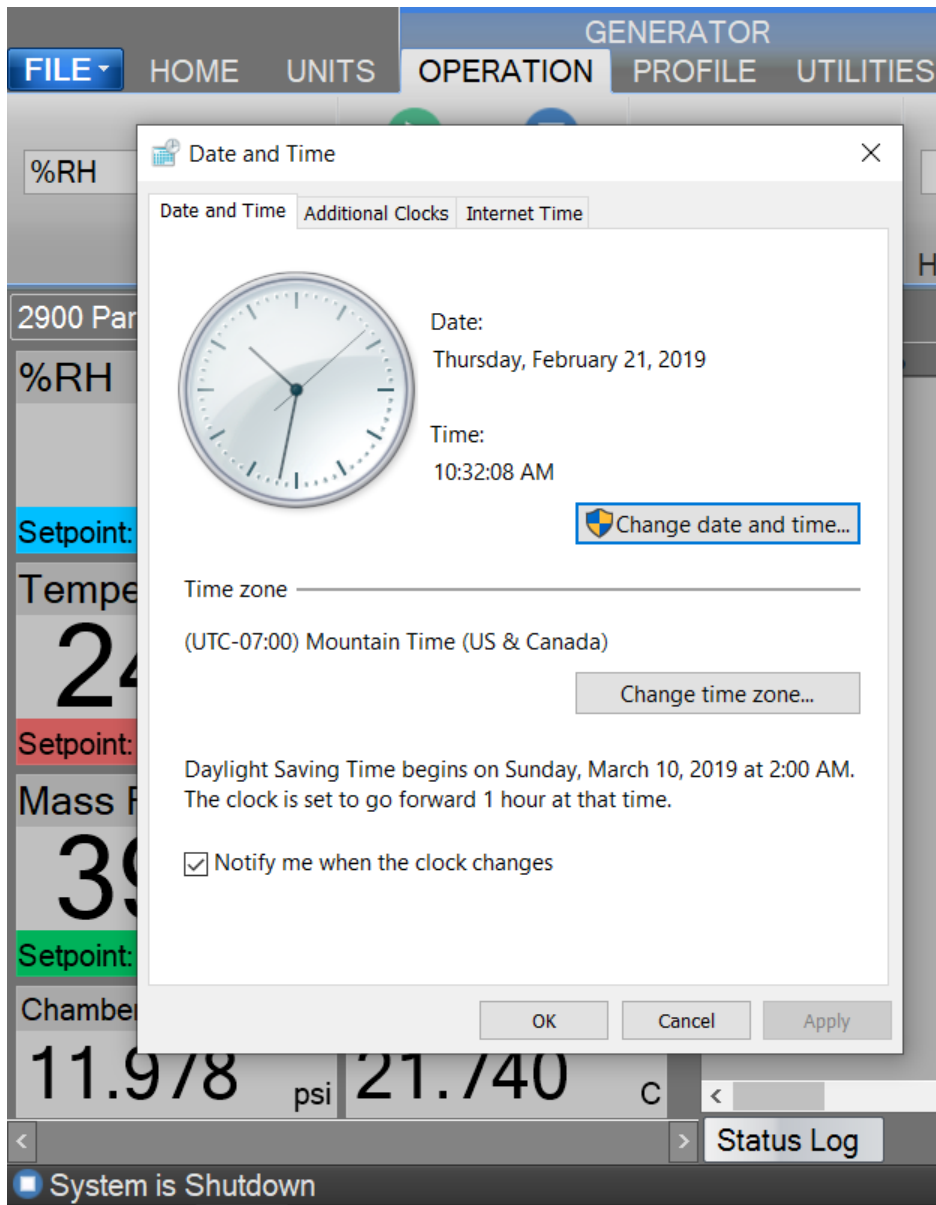

5 FLUID LEVELS

The Fluid Levels dialog allows the user to view the current level of the Water Reservoir along with the states of the liquid level sensors.

To access the Fluid Level dialog, select Reservoir Level from the Generator Utilities menu.

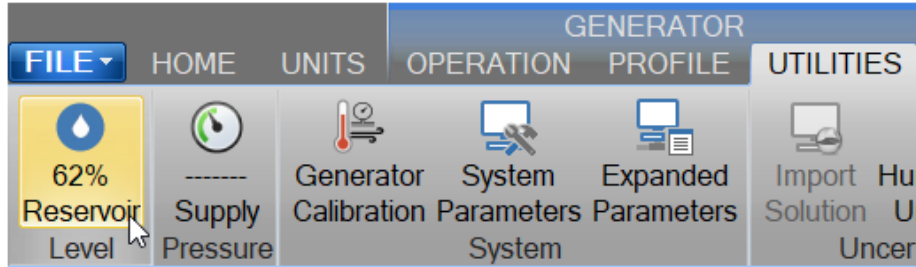

For more information, refer to section [12.4 Fluid System](#)

5.1 WATER RESERVOIR LEVEL

The Water Reservoir Level is the measured distilled water level in the water reservoir and is an indication of the amount of distilled water available to fill the Pre-Saturator during operation. This is the distilled water supply used by the generator to generate a humidified gas output.

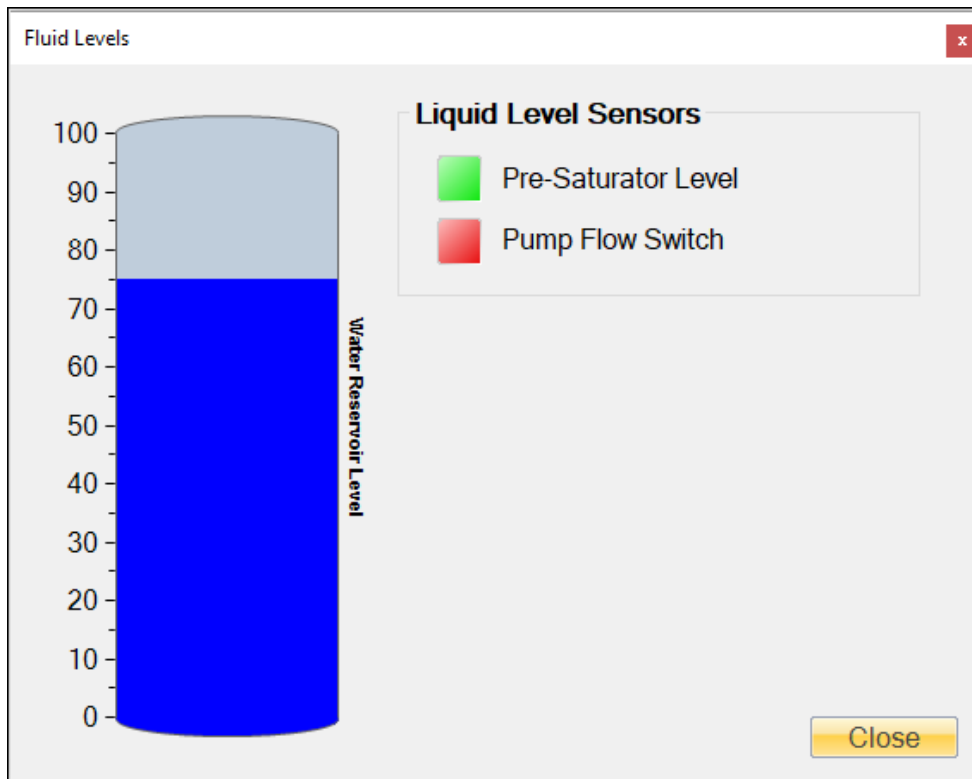

5.1.1 Fill Water Reservoir

- a) Remove the reservoir fill port cap located on the top panel of the system. Attach the provided funnel to fill port.

CAUTION!

THE SYSTEM MUST BE SHUT DOWN AND VENTED OF PRESSURE BEFORE THE WATER RESERVOIR CAN BE FILLED

- b) Add up to 1 gallon (3.8 liters) of double distilled (or better) water until the Water Reservoir Level indicates full. A small funnel may be useful. Add the water slowly so as not to overfill the reservoir.
- c) Remove funnel and replace fill port cap, finger tighten, and proceed with operation.

Note - *If the water reservoir is out of water and the system shuts down with the “Unable to Fill Pre-Saturator Reservoir” error you must refill the water reservoir to a minimum of 75% full before trying to generate again. It is recommended to always fill the reservoir to 100% whenever filling is required.*

It is possible to overfill the reservoir depending on the rate the reservoir is filled. The system will indicate an over filled condition by displaying the tank level in red. In most cases this is not an issue but if the system is filled over 110% there is a possibility that the pre-saturator will become over filled. It is best to drain the pre-saturator and let it refill. Refer to section [13.1 DRAIN PRE-SATURATOR](#).

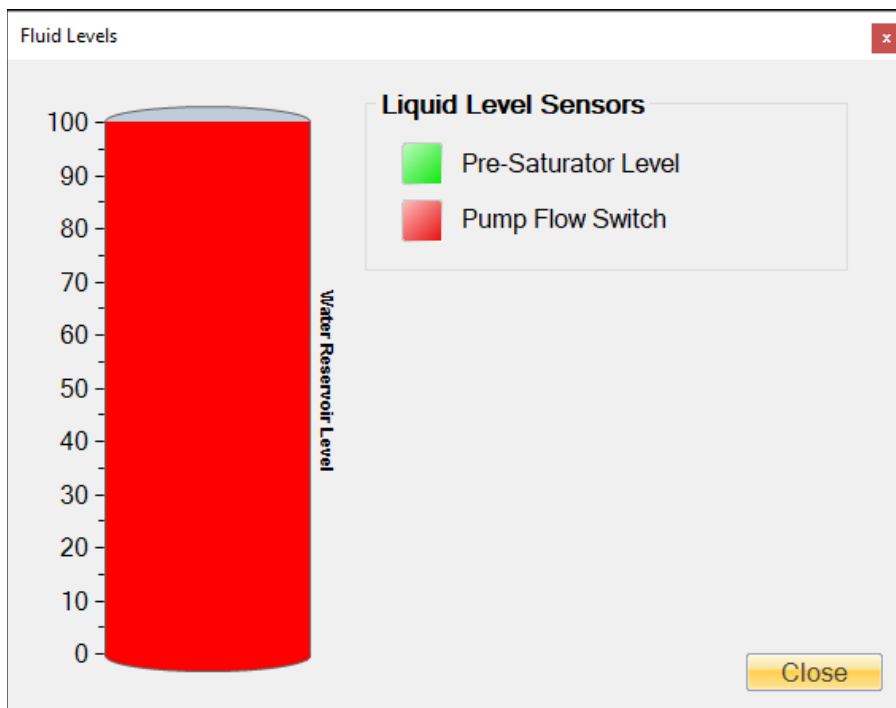

5.2 LIQUID LEVEL SENSORS

Liquid Level Sensors indicate a discrete state of the given sensor. Red indicates no water sensed and green indicates water is sensed. The exception is the pump water circulation Flow Switch (FS1) where red indicates no fluid flow and green indicates the presence of fluid flow.

5.2.1 Pre-Saturator Level

The Pre-Saturator Level is a discrete indication of the Pre-Saturator water level. When the system is shutdown, a click of the label or indicator will start a manual filling process for the Pre-Saturator. This feature is mainly used after the water reservoir tank is filled or when the Pre-Saturator has been drained.

Note - *The system will automatically fill the Pre-Saturator as needed while generating.*

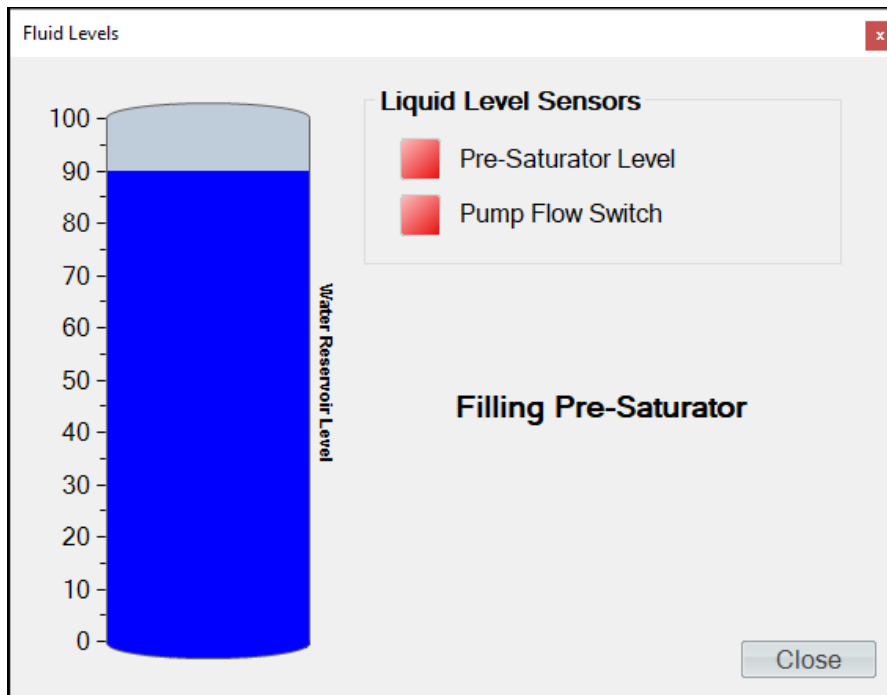

Click the "Pre-Saturator Level" label and the system will open the pre-saturator fill solenoid to allow distilled water to flow from the reservoir to the Pre-Saturator. The system will indicate that it is filling with the message "Filling Pre-Saturator" and will continue the fill process until the Pre-Saturator is full as indicated by the Pre-Saturator Level indication turning green. Once filled the system will automatically stop and close the pre-saturator fill solenoid. The user has the option to cancel the filling operation at any time by clicking the label or indicator again.

5.2.2 Flow Switch

The Flow Switch (FS1) is a discrete indication of the water circulation pump operating correctly. When the flow switch indication is red, water is not being circulated within the system. Water will only be circulated when operating in the Generate mode.

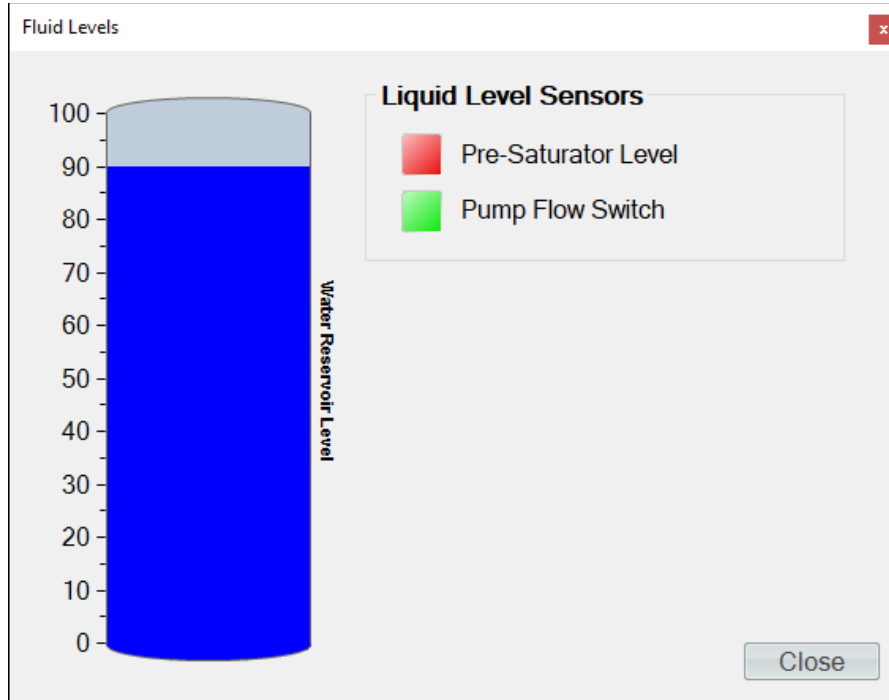

Refer to section [2.12.3.1 Chamber Fluid Filling Procedure](#) for information on adding fluid to the chamber jacket

Refer to section [12.4 Fluid System](#) for information on the system's fluid system.

6 CALIBRATION

Proper calibration of the temperature and pressure transducers is critical to the accuracy of the generated humidity. Each time a probe or transducer is calibrated its current calibration coefficients and calibration data are stored to disk. Calibration of the system requires the following support equipment:

Note - *The following information is provided as a recommendation for the calibration of the Thunder Scientific 2900 Humidity Generator. It is the user's responsibility to ensure the standards used meet/exceed their organization's specific test limit/guard banding requirements.*

- 1) **Temperature**, range 0 to +72 °C (standard range) or -10 to +72 °C (low temp range):
 - Precision temperature bath of specified range with a liquid medium (recommend FC-77 Fluorinert, a 3M product).
Note - *Less stable baths may require the use of a thermal block.*
 - Standard or reference thermometer (PRT) of specified range with an accuracy low enough to assure ± 0.027 °C test limit or guard band.
- 2) **Chamber Pressure**, range ambient to 17 psi absolute:
 - Stable static gas pressure source.
 - Standard or reference pressure gauge with an accuracy low enough to assure ± 0.020 % of reading test limit or guard band.
- 3) **Saturation Pressure**, range ambient to 160 psi absolute:
 - Stable static gas pressure source.
 - Standard or reference pressure gauge with an accuracy low enough to assure ± 0.020 % of full-scale ($160 * \pm 0.020\% = \pm 0.032$ psi absolute) test limit or guard band.
- 5) **Flow**, range 0 to 50 standard liters/min:
 - Reference flow meter with an accuracy low enough to assure ± 5.0 % of full-scale ($50.0 * \pm 5.0\% = \pm 2.5$ liter/min) test limit or guard band.
Note – *Flow is standardized with a reference temperature of 70.0 °F at 760 torr*

6.1 TEMPERATURE CALIBRATION

The temperature calibration procedure is used in conjunction with a precision temperature bath for calibration of the temperature probes. By using the temperature bath to generate up to five known temperatures, all coefficients will be calculated automatically by the computer and used to update the system calibration. Calibration reports will be generated and can be saved for each of the temperature probes at the conclusion of each calibration sequence.

Refer to drawings: [18D29901-1](#), [18D29901-3](#), [18D29901-4](#)

6.1.1 Equipment Required

1. Precision Temperature Bath.
2. Standard or Reference thermometer.
3. #10 Torx Driver
4. Temp Probe Tool #20M00305
5. Long nose pliers
6. 1/2" & 9/16" wrenches

6.1.2 Calibration Procedure

For safety purposes, perform a [shutdown](#), perform a [shutdown system](#), switch system "POWER" to OFF and remove power cord before removing any panel or air supply line.

1. Disconnect the air supply line to generator and remove air supply inlet fitting.
2. Remove the top, left and rear panels.
3. Remove temperature probes to be calibrated:

Note - *The Cabinet Temp (RTD5) does not require calibration and can't be removed.*

- Chamber Temperature Probe (RTD4): Remove the access port insulation. Using the Long Nose Pliers, grasp the rubber cork and pull straight up. Remove the probe by feeding the cable and probe up and through the chamber access port.
 - Saturation Temperature Probe (RTD1): Remove the access port insulation. Using the "Temp Probe Tool", loosen the captive nut ½ turn counterclockwise (do not remove captive nut) and remove the probe by pulling straight up from the access port fitting.
 - Expansion Valve Temperature Probe (RTD3): To access to the Expansion Valve Temperature Probe, remove the expansion valve access cover. Remove the expansion valve insulation. Using the "Temp Probe Tool", loosen the knurled compression nut ½ turn counterclockwise (do not remove captive nut). Gently pull the probe straight up to remove probe.
 - Presaturator Temperature Probe (RTD2): Remove the Presaturator Temperature Probe by pulling the "Probe Captive Stay" straight down then pull the Presaturator Temperature Probe straight down from the thermal well. Pull the cable and probe up and through the 2900 frame corner
4. Bring a precision temperature bath with reference thermometer to the system. Pull the split tube temperature probe covering from the frame corners to allow the temperature probes to reach the temperature bath. Install the temperature probes into temperature bath.
 5. Switch main console power ON. Wait a few moments for the system to initialize and for the Control/Display screen to appear.

CAUTION!

DO NOT ENABLE CONTROL BY SELECTING GENERATE WITH ANY TEMPERATURE PROBE REMOVED FROM THE SYSTEM.

From the Units menu tab select the desired temperature units for calibration. Once calibration has begun, the units should not be changed again until the calibration is complete.

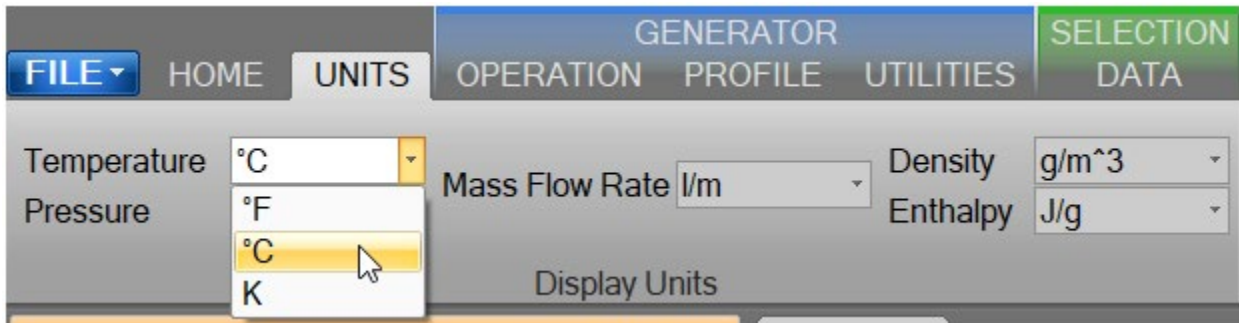

Select Generator Calibration from the Utilities menu tab to open the Calibration Wizard.

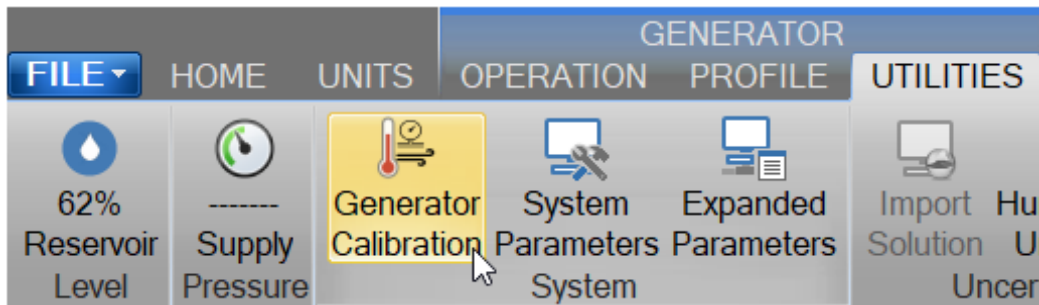

Select, "Take "As Received" points". This will allow the user to take points with the current calibration to determine out of tolerance. After all "As Received" points have been taken the user will be asked whether they want to calculate new calibration coefficients.

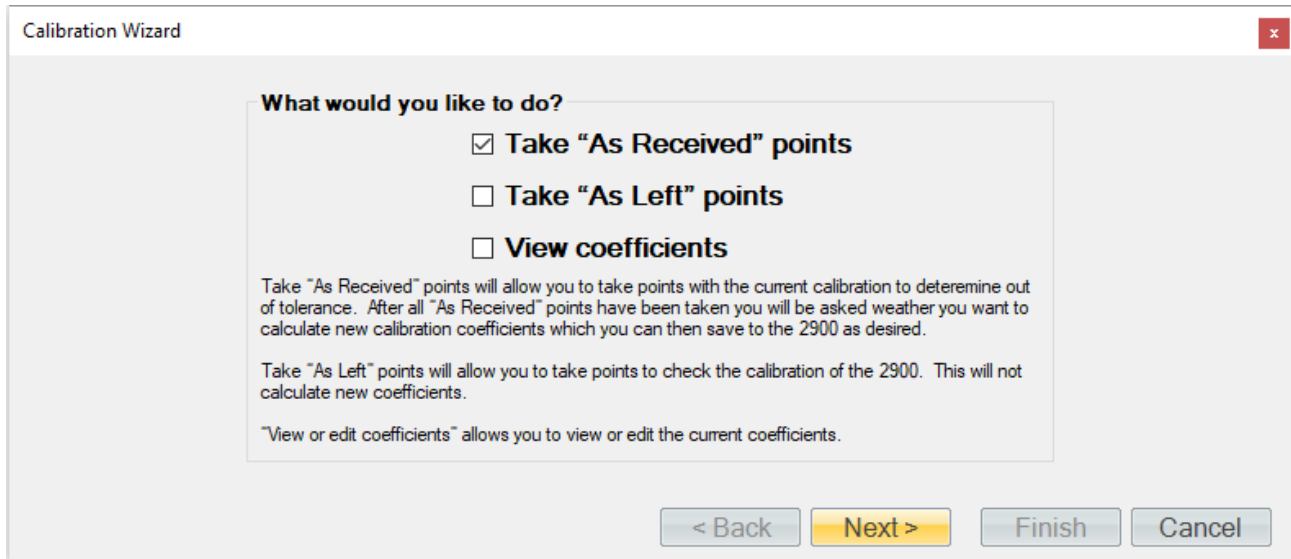

Set the type of calibration to Temperature.

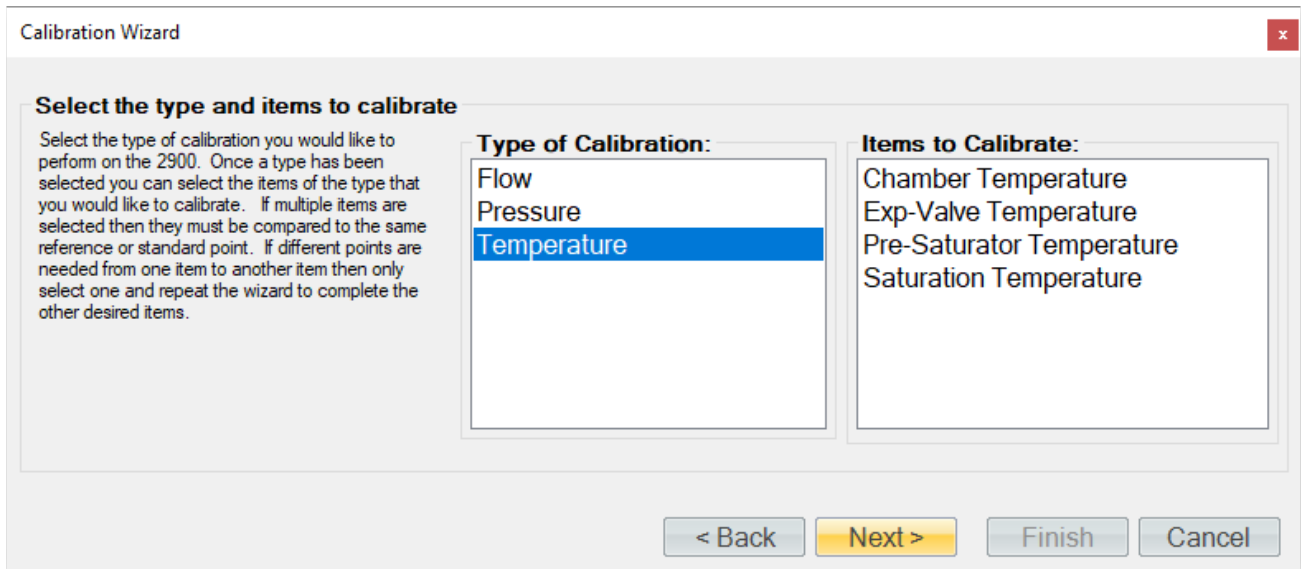

Select the temperature probes to be calibrated. In most case this will be all four probes, but the user is able to calibrate any given probe separately or together.

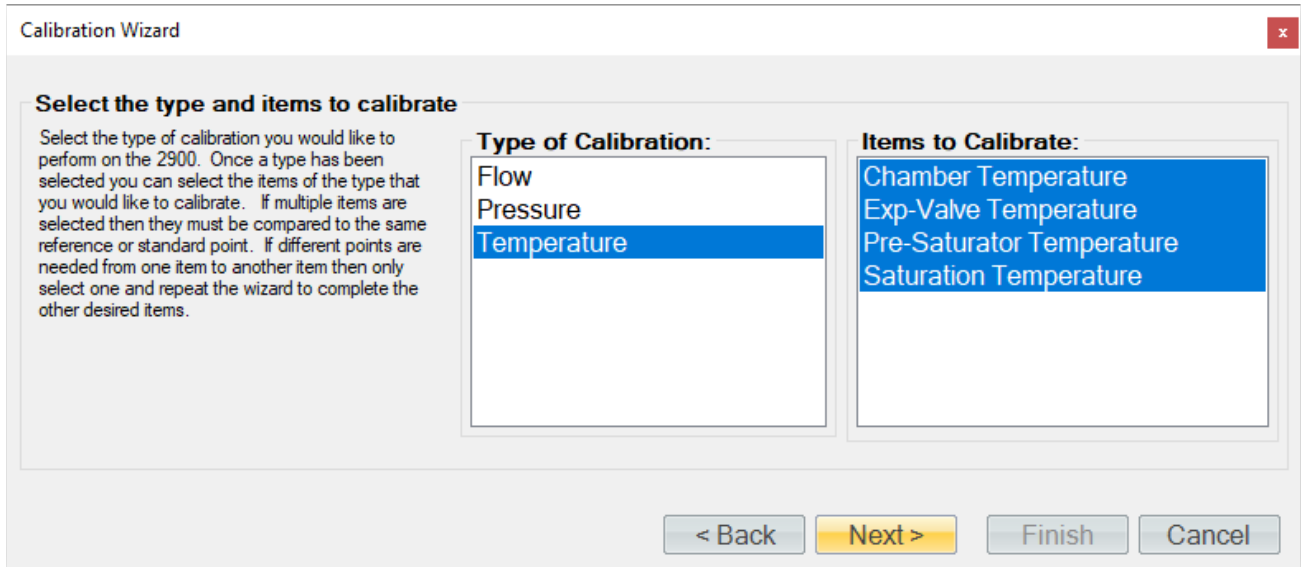

If the temperature standard is a connected device (refer to section [9 Connections](#)), you may select it for the calibration. You can use a single device item with the same calibration type from any connected device. ControLog will automatically record the standard's value during each calibration point. If the standard is not connected or if you desire to manually enter the standard's value, then simply do not select an item from the list.

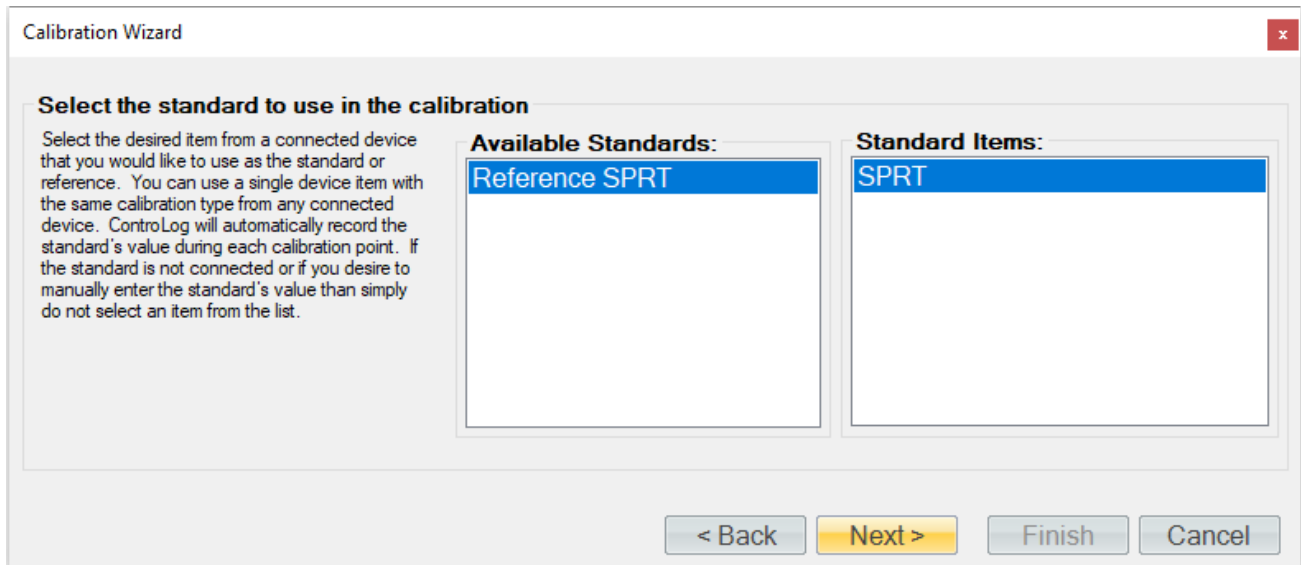

Enter the Name and ID of the standard being used. This information will be populated on the calibration report. Selecting “Next” without entering a Name will result in ControLog giving the standard a generic name.

The screenshot shows a dialog box titled "Calibration Wizard" with a close button (X) in the top right corner. The main content area is titled "Enter the name and ID for the standard". It contains two input fields: "Name:" and "ID:". Below these fields is a descriptive text: "Enter the name and ID for the standard or reference that will be used for this calibration." At the bottom of the dialog, there are four buttons: "< Back", "Next >" (highlighted in yellow), "Finish", and "Cancel".

Enter the desired calibration tolerance or guard band for the calibration. ControLog will signal the user that a calibration item is out of tolerance based on the value entered above.

The screenshot shows a dialog box titled "Calibration Wizard" with a close button (X) in the top right corner. The main content area is titled "Enter calibration tolerance". It features a text input field with the value "± 0.027". Below the input field is a paragraph of text: "Enter the desired calibration tolerance or guardband for the calibration. ControLog will signal the user that a calibration item is out of tolerance based on the value entered above." This is followed by a longer paragraph: "The tolerance is the allowable variation between the standard or reference and the item being calibrated. This is best thought of as a window based on a minimum and maximum value, the minimum being the standard minus the tolerance and the maximum being the standard plus the tolerance. If the value of the item being calibrated is outside the window then item is considered out of tolerance." At the bottom of the dialog, there are four buttons: "< Back", "Next >" (highlighted in yellow), "Finish", and "Cancel".

The tolerance is the allowable variation between the standard or reference and the item being calibrated. This is best thought of as a window based on a minimum and maximum value, the minimum being the standard minus the tolerance and the maximum being the standard plus the tolerance. If the value of the item being calibrated is outside the window, then the item is considered out of tolerance.

An out of tolerance condition will be indicated by a red circle with an exclamation point  for the out of tolerance probe in the Error column.

Calibration Wizard

Take "As Received" point 1

	Value [C]	Raw Value	Error [C]	Std Dev [C]
Standard	0.0000			
Chamber Temperature	0.0280	0.0280	 0.0280	
Exp-Valve Temperature	0.0260	0.0260	0.0260	
Pre-Saturator Temperature	0.0260	0.0260	0.0260	
Saturation Temperature	0.0260	0.0260	0.0260	

Take an "As Received" calibration point by moving the system to the desired Temperature value for this point. Once the reading or readings are stable, click the "Take Point" button. Once a point has been taken the wizard will automatically advance to the next point. Use the "Next" and "Back" button to navigate between taken points. You can clear and retake a point by simply clicking the "Clear Point" button and then repeat the process to retake the point.

Take Point 1

< Back Next > Finish Cancel

Enter the sample size used to perform the standard deviation calculation. The sample size is the given time that ControLog will use to determine which data points to use to determine the standard deviation of each probe.

Note - The number of points used will be based on the data storage rate you have selected along with the desired sample size. For example, if the data storage rate is every 30 seconds then a sample size of 10 minutes will result in 20 points being used to calculate the standard deviation.

Calibration Wizard

Enter sample size

10.0 minutes

Enter the desired sample size for standard deviation calculation.

Standard deviation is a statistic used to measure the variation in the actual data and can be thought of as how spread out or stable the data is. ControLog calculates the Standard Deviation from the device data tab for the points within the given sample size. Note: The sample size should always be carefully considered based on the data storage interval. Too small of a sample size in relation to the data storage interval will result in a small number of points used to calculate the Standard Deviation.

< Back Next > Finish Cancel

Select the number of points you would like to take for this “As Received” calibration. Each point defines what the “true” value is at a given point based on the standard or reference value. The number of points determines the degree of the polynomial used to align or correct the generator with the standard or reference.

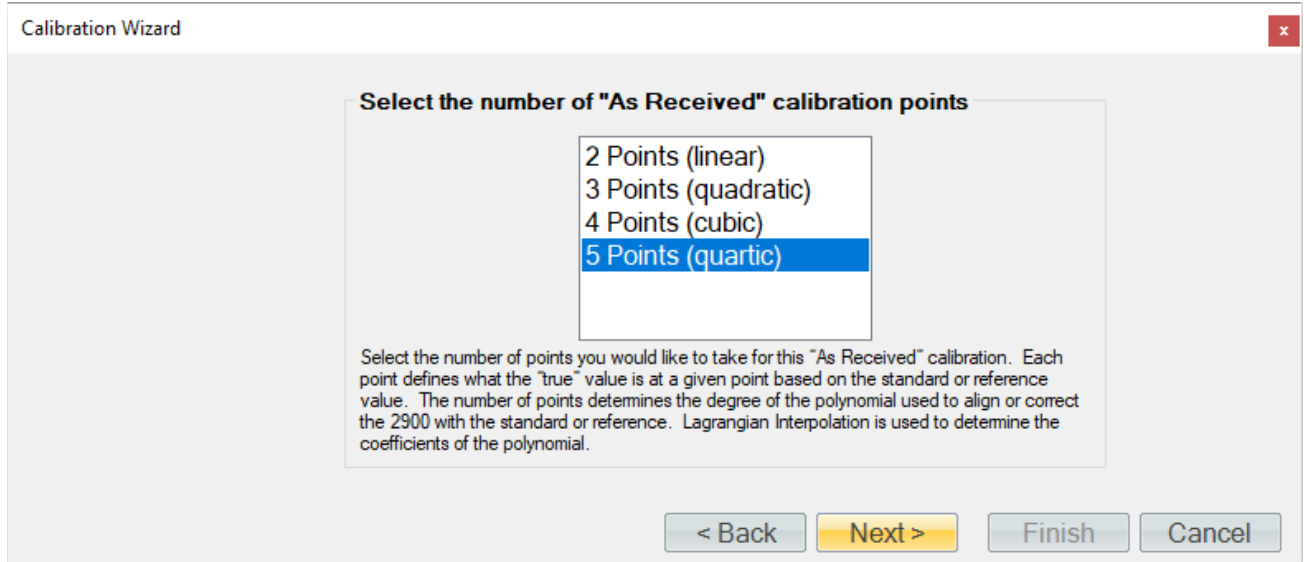

Using the temperature bath, generate the first temperature point (0 °C). If the standard is not a connected device, then ControLog will ask for the value before taking the point. You can also enter a standard or reference value before taking a point by clicking the cell in the “Standard” row and “Value” column. This is useful for seeing error values before a point is taken.

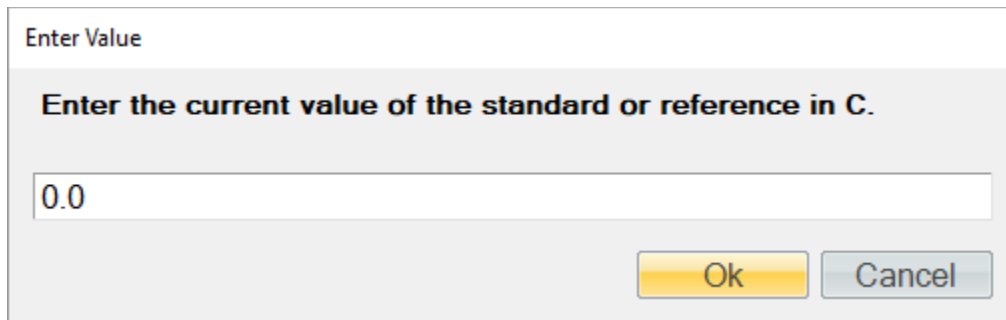

Once the readings are stable, click the “Take Point” button. Then once a point has been taken the wizard will automatically advance to the next point.

Calibration Wizard

Take "As Received" point 1

	Value [C]	Raw Value	Error [C]	Std Dev [C]
Standard	0.0000			
Chamber Temperature	-0.0097	-0.0101	-0.0097	0.0027
Exp-Valve Temperature	-0.0083	-0.0077	-0.0083	0.0022
Pre-Saturator Temperature	-0.0120	-0.0131	-0.0120	0.0027
Saturation Temperature	-0.0099	-0.0093	-0.0099	0.0022

Take an "As Received" calibration point by moving the system to the desired Temperature value for this point. Once the reading or readings are stable, click the "Take Point" button. Once a point has been taken the wizard will automatically advance to the next point. Use the "Next" and "Back" button to navigate between taken points. You can clear and retake a point by simply clicking the "Clear Point" button and then repeat the process to retake the point.

Take Point 1

< Back Next > Finish Cancel

Tip - Use the “Next” and “Back” button to navigate between taken points. You can clear and retake a point by simply clicking the “Clear Point” button and then repeat the process to retake the point.

Calibration Wizard

"As Received" Calibration point 1

	Value [C]	Raw Value	Error [C]	Std Dev [C]
Standard	0.0000			
Chamber Temperature	-0.0097	-0.0101	-0.0097	0.0027
Exp-Valve Temperature	-0.0083	-0.0077	-0.0083	0.0022
Pre-Saturator Temperature	-0.0120	-0.0131	-0.0120	0.0027
Saturation Temperature	-0.0099	-0.0093	-0.0099	0.0022

Take an "As Received" calibration point by moving the system to the desired Temperature value for this point. Once the reading or readings are stable, click the "Take Point" button. Once a point has been taken the wizard will automatically advance to the next point. Use the "Next" and "Back" button to navigate between taken points. You can clear and retake a point by simply clicking the "Clear Point" button and then repeat the process to retake the point.

Clear Point 1

< Back Next > Finish Cancel

Using the temperature bath, generate the second temperature point (17.5 °C). Once the readings are stable enter the standards value and click the “Take Point” button.

Calibration Wizard ✕

Take "As Received" point 2

	Value [C]	Raw Value	Error [C]	Std Dev [C]
Standard	17.5000			
Chamber Temperature	17.4951	17.4958	-0.0049	0.0030
Exp-Valve Temperature	17.4892	17.4896	-0.0108	0.0125
Pre-Saturator Temperature	17.4900	17.4901	-0.0100	0.0037
Saturation Temperature	17.4964	17.4964	-0.0036	0.0018

Take an "As Received" calibration point by moving the system to the desired Temperature value for this point. Once the reading or readings are stable, click the "Take Point" button. Once a point has been taken the wizard will automatically advance to the next point. Use the "Next" and "Back" button to navigate between taken points. You can clear and retake a point by simply clicking the "Clear Point" button and then repeat the process to retake the point.

Take Point 2

Using the temperature bath, generate the third temperature point (35 °C). Once the readings are stable enter the standards value and click the “Take Point” button.

Calibration Wizard ✕

Take "As Received" point 3

	Value [C]	Raw Value	Error [C]	Std Dev [C]
Standard	35.0000			
Chamber Temperature	35.0020	35.0016	0.0020	0.0008
Exp-Valve Temperature	35.0016	35.0010	0.0016	0.0006
Pre-Saturator Temperature	35.0015	35.0014	0.0015	0.0003
Saturation Temperature	35.0008	34.9999	0.0008	0.0002

Take an "As Received" calibration point by moving the system to the desired Temperature value for this point. Once the reading or readings are stable, click the "Take Point" button. Once a point has been taken the wizard will automatically advance to the next point. Use the "Next" and "Back" button to navigate between taken points. You can clear and retake a point by simply clicking the "Clear Point" button and then repeat the process to retake the point.

Take Point 3

Using the temperature bath, generate the fourth temperature point (52.5 °C). Once the readings are stable enter the standards value and click the “Take Point” button.

Calibration Wizard

Take "As Received" point 4

	Value [C]	Raw Value	Error [C]	Std Dev [C]
Standard	52.5000			
Chamber Temperature	52.5067	52.5065	0.0067	0.0015
Exp-Valve Temperature	52.5079	52.5075	0.0079	0.0014
Pre-Saturator Temperature	52.5050	52.5048	0.0050	0.0013
Saturation Temperature	52.5036	52.5031	0.0036	0.0007

Take an "As Received" calibration point by moving the system to the desired Temperature value for this point. Once the reading or readings are stable, click the "Take Point" button. Once a point has been taken the wizard will automatically advance to the next point. Use the "Next" and "Back" button to navigate between taken points. You can clear and retake a point by simply clicking the "Clear Point" button and then repeat the process to retake the point.

Take Point 4

< Back Next > Finish Cancel

Using the temperature bath, generate the last temperature point (70 °C). Once the readings are stable enter the standards value and click the “Take Point” button.

Calibration Wizard

Take "As Received" point 5

	Value [C]	Raw Value	Error [C]	Std Dev [C]
Standard	70.0000			
Chamber Temperature	70.0034	70.0035	0.0034	0.0011
Exp-Valve Temperature	70.0043	70.0032	0.0043	0.0012
Pre-Saturator Temperature	70.0039	70.0035	0.0039	0.0010
Saturation Temperature	70.0043	70.0041	0.0043	0.0010

Take an "As Received" calibration point by moving the system to the desired Temperature value for this point. Once the reading or readings are stable, click the "Take Point" button. Once a point has been taken the wizard will automatically advance to the next point. Use the "Next" and "Back" button to navigate between taken points. You can clear and retake a point by simply clicking the "Clear Point" button and then repeat the process to retake the point.

Take Point 5

< Back Next > Finish Cancel

When all temperature points have been entered, ControLog will advance to the “As Received” calibration report. Each temperature probe will appear in its own tab and contains the data for each calibration point along with the coefficients used at the time the points were taken.

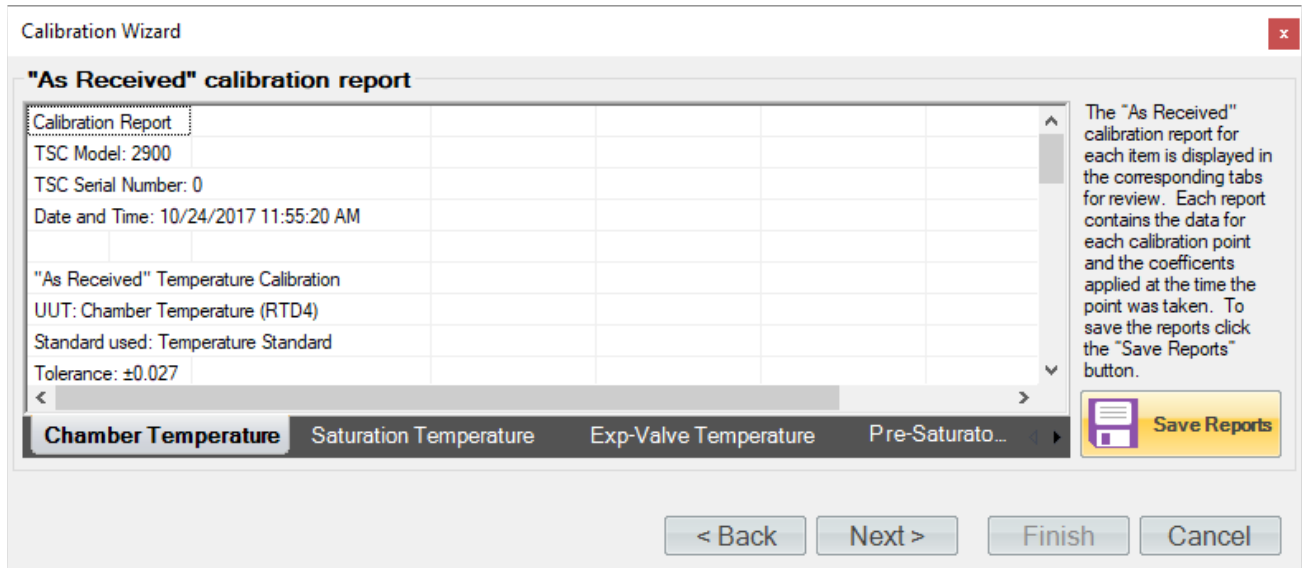

Clicking the “Save Reports” button will open a file dialog to save the report. The default file location is ...Documents\Thunder Scientific\2900 ControLog\Reports\. If the report is saved in an Excel format, then each probe will appear in its own tab within the workbook. The user needs to save in a text-based format then a file for each probe calibrated will be created.

Clicking “Next” will ask the user if they want to calculate new coefficients using the “As Received” data points just taken.

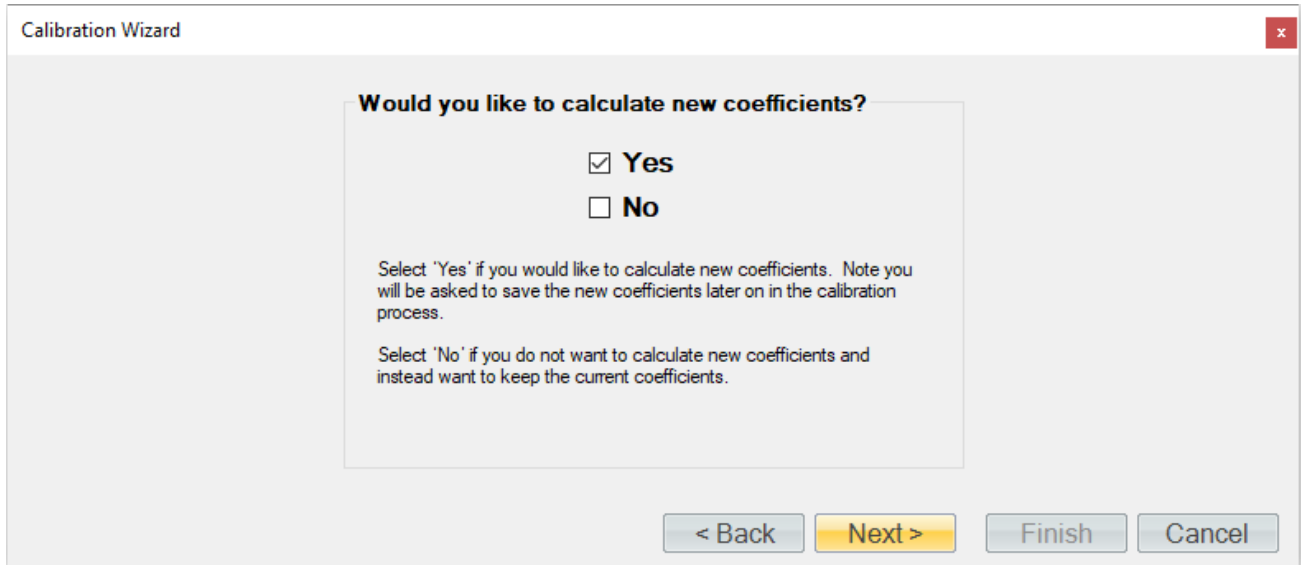

If the user selected to calculate new coefficients, they will be calculated and displayed. If any problem calculating the coefficient occurs, ControLog will issue a message telling the user that the coefficients could not be calculated.

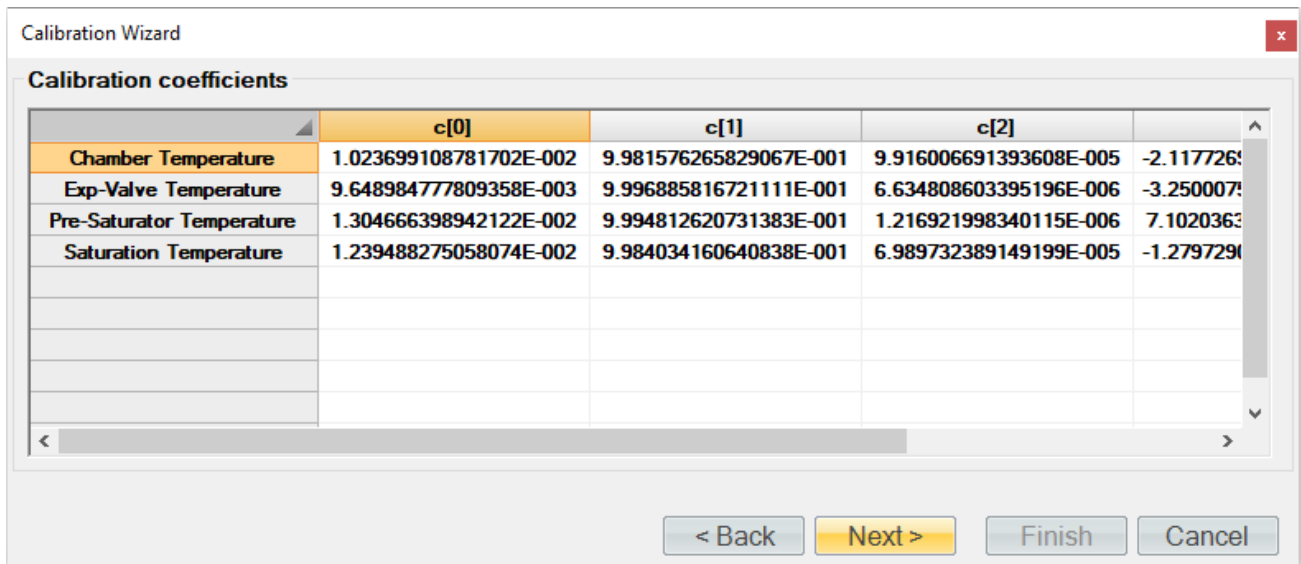

Next, the user will be asked to save the new coefficients to the system. Selecting “Yes” will result in the current coefficient being over-written by the newly calculated coefficients.

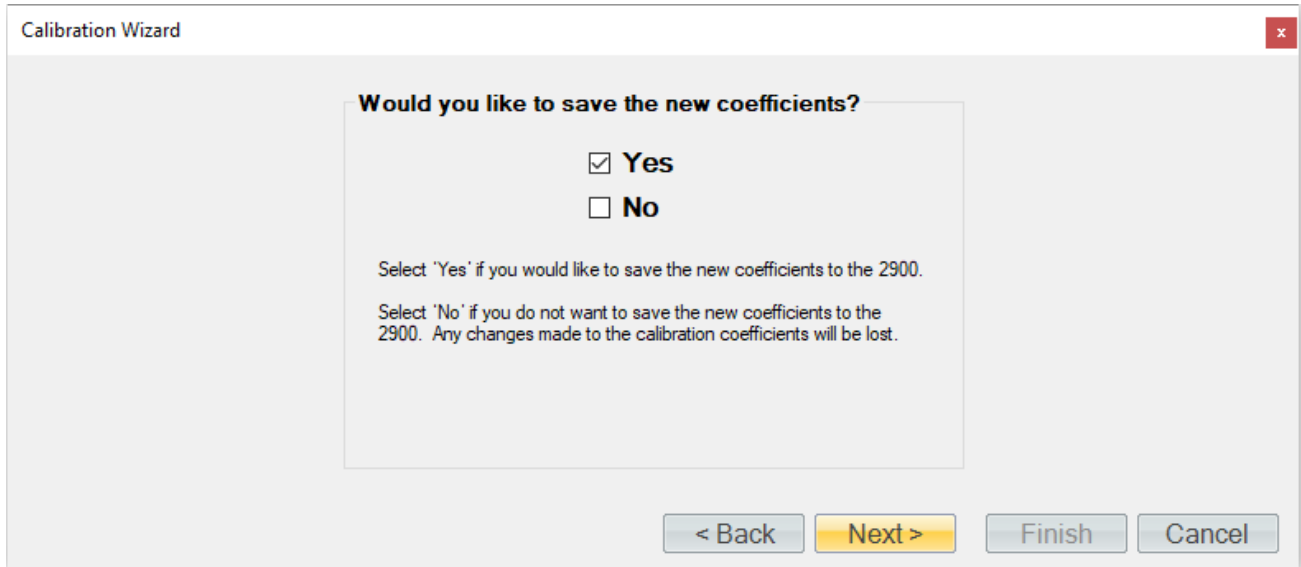

Next, the user can view and save the calibration coefficients report for each probe.

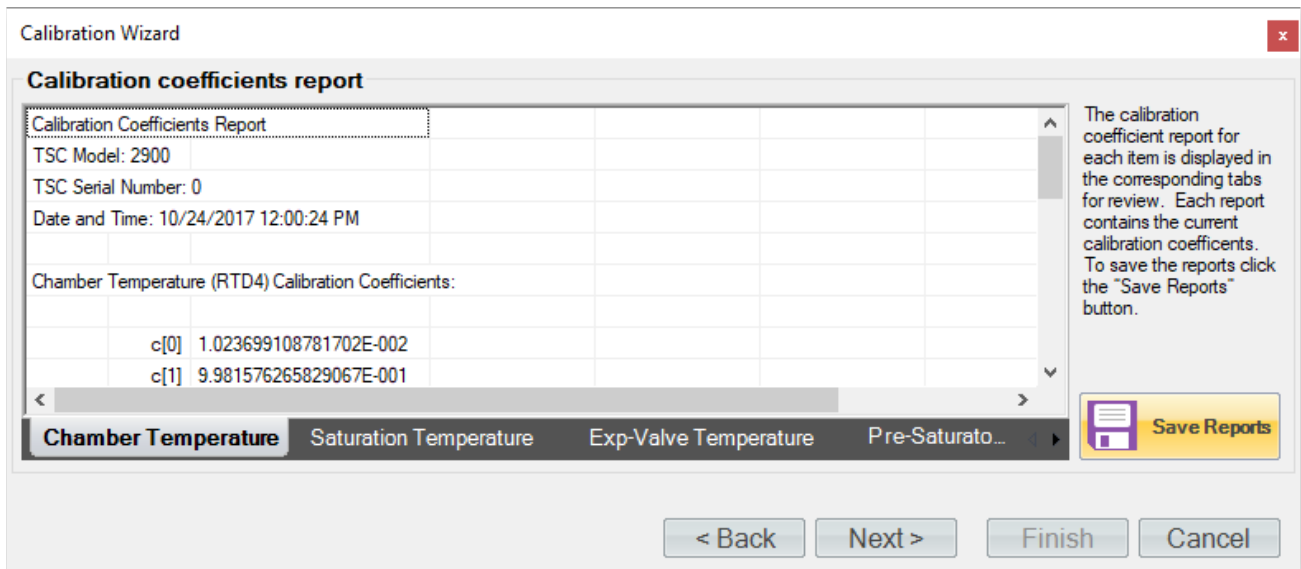

Next, the user can complete the calibration or can choose to take “As Left” points.

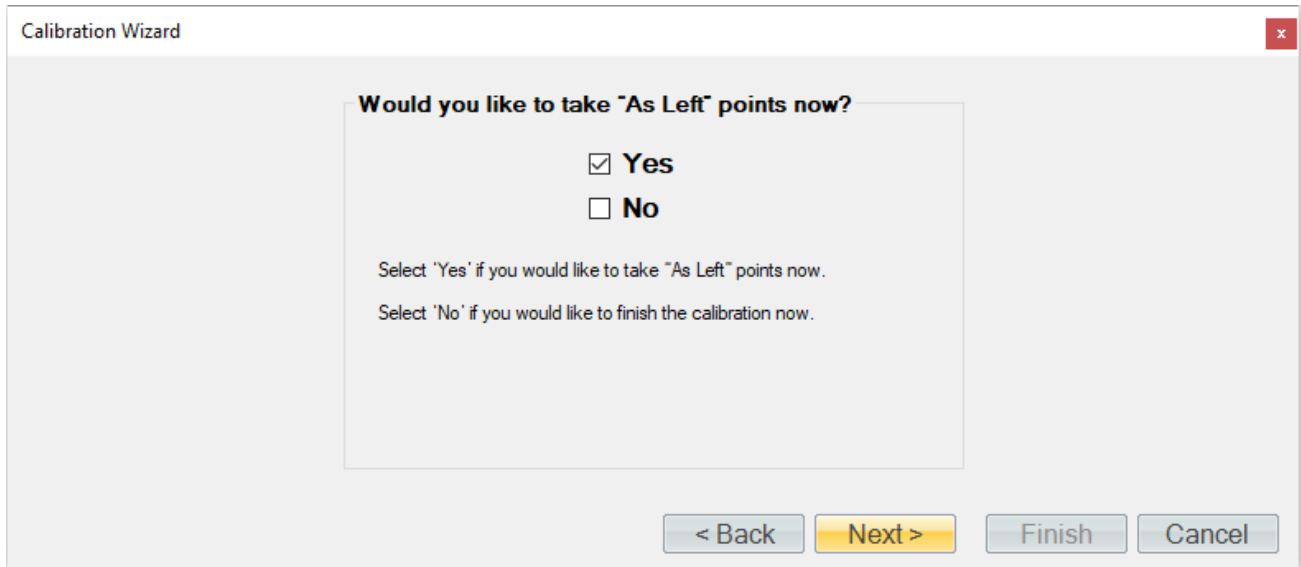

The screenshot shows a window titled "Calibration Wizard" with a close button in the top right corner. The main content area contains a question: "Would you like to take 'As Left' points now?". Below the question are two radio button options: "Yes" (which is selected) and "No". Underneath these options, there are two lines of explanatory text: "Select 'Yes' if you would like to take 'As Left' points now." and "Select 'No' if you would like to finish the calibration now." At the bottom of the dialog, there are four buttons: "< Back", "Next >" (highlighted in yellow), "Finish", and "Cancel".

ControLog allows the user to take as many “As Left” points as they would like. In this example we will check every 10°C points starting at 70 °C and ending at 0 °C. If the standard is not a connected device then ControLog will ask for the value before taking the point. You can also enter a standard or reference value before taking a point by clicking the cell in the “Standard” row and “Value” column. This is useful for seeing error values before a point is taken.

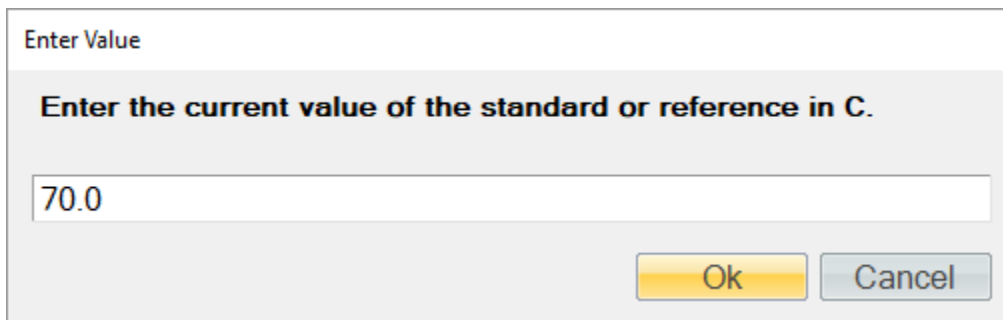

The screenshot shows a dialog box titled "Enter Value". The main text inside the dialog reads: "Enter the current value of the standard or reference in C." Below this text is a text input field containing the value "70.0". At the bottom right of the dialog, there are two buttons: "Ok" (highlighted in yellow) and "Cancel".

Once the readings are stable, enter the standards value and click the "Take Point" button. Once a point has been taken, the wizard will automatically advance to the next point.

Calibration Wizard

Take "As Left" point 1

	Value [C]	Raw Value	Error [C]	Std Dev [C]
Standard	70.0000			
Chamber Temperature	69.9979	70.0007	-0.0021	0.0166
Exp-Valve Temperature	70.0055	70.0105	0.0055	0.0092
Pre-Saturator Temperature	69.9945	69.9992	-0.0055	0.0154
Saturation Temperature	69.9992	70.0074	-0.0008	0.0098

Take an "As Left" calibration point by moving the system to the desired Temperature value for this point. Once the reading or readings are stable, click the "Take Point" button. Once a point has been taken the wizard will automatically advance to the next point. Use the "Next" and "Back" button to navigate between taken points. You can clear and retake a point by simply clicking the "Clear Point" button and then repeat the process to retake the point.

Take Point 1

< Back Next > Finish Cancel

Tip - Use the "Next" and "Back" button to navigate between taken points. You can clear and retake a point by simply clicking the "Clear Point" button and then repeat the process to retake the point.

Calibration Wizard

"As Left" point 1

	Value [C]	Raw Value	Error [C]	Std Dev [C]
Standard	70.0000			
Chamber Temperature	69.9979	70.0007	-0.0021	0.0166
Exp-Valve Temperature	70.0055	70.0105	0.0055	0.0092
Pre-Saturator Temperature	69.9945	69.9992	-0.0055	0.0154
Saturation Temperature	69.9992	70.0074	-0.0008	0.0098

Take an "As Left" calibration point by moving the system to the desired Temperature value for this point. Once the reading or readings are stable, click the "Take Point" button. Once a point has been taken the wizard will automatically advance to the next point. Use the "Next" and "Back" button to navigate between taken points. You can clear and retake a point by simply clicking the "Clear Point" button and then repeat the process to retake the point.

Clear Point 1

< Back Next > Finish Cancel

Using the temperature bath, generate the next temperature point (60 °C). Once the readings are stable, enter the standards value and click the “Take Point” button.

Calibration Wizard

Take "As Left" point 2

	Value [C]	Raw Value	Error [C]	Std Dev [C]
Standard	60.0000			
Chamber Temperature	60.0024	60.0117	0.0024	0.0022
Exp-Valve Temperature	59.9984	60.0083	-0.0016	0.0024
Pre-Saturator Temperature	60.0029	60.0074	0.0029	0.0021
Saturation Temperature	60.0058	60.0110	0.0058	0.0021

Take an "As Left" calibration point by moving the system to the desired Temperature value for this point. Once the reading or readings are stable, click the "Take Point" button. Once a point has been taken the wizard will automatically advance to the next point. Use the "Next" and "Back" button to navigate between taken points. You can clear and retake a point by simply clicking the "Clear Point" button and then repeat the process to retake the point.

Take Point 2

< Back Next > Finish Cancel

Using the temperature bath, generate the next temperature point (50 °C). Once the readings are stable, enter the standards value and click the “Take Point” button.

Calibration Wizard

Take "As Left" point 3

	Value [C]	Raw Value	Error [C]	Std Dev [C]
Standard	50.0000			
Chamber Temperature	50.0054	50.0132	0.0054	0.0031
Exp-Valve Temperature	50.0046	50.0138	0.0046	0.0031
Pre-Saturator Temperature	50.0008	50.0066	0.0008	0.0026
Saturation Temperature	50.0038	50.0089	0.0038	0.0021

Take an "As Left" calibration point by moving the system to the desired Temperature value for this point. Once the reading or readings are stable, click the "Take Point" button. Once a point has been taken the wizard will automatically advance to the next point. Use the "Next" and "Back" button to navigate between taken points. You can clear and retake a point by simply clicking the "Clear Point" button and then repeat the process to retake the point.

Take Point 3

< Back Next > Finish Cancel

Using the temperature bath, generate the next temperature point (40 °C). Once the readings are stable, enter the standards value and click the “Take Point” button.

Calibration Wizard x

Take "As Left" point 4

	Value [C]	Raw Value	Error [C]	Std Dev [C]
Standard	40.0000			
Chamber Temperature	39.9906	39.9951	-0.0094	0.0021
Exp-Valve Temperature	40.0011	40.0077	0.0011	0.0021
Pre-Saturator Temperature	40.0011	40.0055	0.0011	0.0019
Saturation Temperature	39.9996	40.0028	-0.0004	0.0097

Take an "As Left" calibration point by moving the system to the desired Temperature value for this point. Once the reading or readings are stable, click the "Take Point" button. Once a point has been taken the wizard will automatically advance to the next point. Use the "Next" and "Back" button to navigate between taken points. You can clear and retake a point by simply clicking the "Clear Point" button and then repeat the process to retake the point.

Take Point 4

Using the temperature bath, generate the next temperature point (30 °C). Once the readings are stable, enter the standards value and click the “Take Point” button.

Calibration Wizard x

Take "As Left" point 5

	Value [C]	Raw Value	Error [C]	Std Dev [C]
Standard	30.0000			
Chamber Temperature	30.0130	30.0146	0.0130	0.0029
Exp-Valve Temperature	30.0094	30.0090	0.0094	0.0026
Pre-Saturator Temperature	30.0110	30.0125	0.0110	0.0028
Saturation Temperature	30.0133	30.0156	0.0133	0.0025

Take an "As Left" calibration point by moving the system to the desired Temperature value for this point. Once the reading or readings are stable, click the "Take Point" button. Once a point has been taken the wizard will automatically advance to the next point. Use the "Next" and "Back" button to navigate between taken points. You can clear and retake a point by simply clicking the "Clear Point" button and then repeat the process to retake the point.

Take Point 5

Using the temperature bath, generate the next temperature point (20 °C). Once the readings are stable, enter the standards value and click the “Take Point” button.

Calibration Wizard

Take "As Left" point 6

	Value [C]	Raw Value	Error [C]	Std Dev [C]
Standard	20.0000			
Chamber Temperature	19.9982	19.9997	-0.0018	0.0057
Exp-Valve Temperature	20.0102	20.0067	0.0102	0.0055
Pre-Saturator Temperature	20.0129	20.0104	0.0129	0.0011
Saturation Temperature	20.0032	20.0053	0.0032	0.0007

Take an "As Left" calibration point by moving the system to the desired Temperature value for this point. Once the reading or readings are stable, click the "Take Point" button. Once a point has been taken the wizard will automatically advance to the next point. Use the "Next" and "Back" button to navigate between taken points. You can clear and retake a point by simply clicking the "Clear Point" button and then repeat the process to retake the point.

Take Point 6

< Back Next > Finish Cancel

Using the temperature bath, generate the next temperature point (10 °C). Once the readings are stable, enter the standards value and click the “Take Point” button.

Calibration Wizard

Take "As Left" point 7

	Value [C]	Raw Value	Error [C]	Std Dev [C]
Standard	10.0000			
Chamber Temperature	10.0127	10.0057	0.0127	0.0046
Exp-Valve Temperature	10.0121	10.0038	0.0121	0.0046
Pre-Saturator Temperature	10.0120	10.0059	0.0120	0.0030
Saturation Temperature	10.0077	10.0076	0.0077	0.0029

Take an "As Left" calibration point by moving the system to the desired Temperature value for this point. Once the reading or readings are stable, click the "Take Point" button. Once a point has been taken the wizard will automatically advance to the next point. Use the "Next" and "Back" button to navigate between taken points. You can clear and retake a point by simply clicking the "Clear Point" button and then repeat the process to retake the point.

Take Point 7

< Back Next > Finish Cancel

Using the temperature bath, generate the next temperature point (0 °C). Once the readings are stable, enter the standards value and click the “Take Point” button.

Calibration Wizard

Take "As Left" point 8

	Value [C]	Raw Value	Error [C]	Std Dev [C]
Standard	0.0000			
Chamber Temperature	0.0051	-0.0051	0.0051	0.0043
Exp-Valve Temperature	0.0016	-0.0091	0.0016	0.0041
Pre-Saturator Temperature	0.0141	0.0003	0.0141	0.0018
Saturation Temperature	0.0138	0.0003	0.0138	0.0020

Take an "As Left" calibration point by moving the system to the desired Temperature value for this point. Once the reading or readings are stable, click the "Take Point" button. Once a point has been taken the wizard will automatically advance to the next point. Use the "Next" and "Back" button to navigate between taken points. You can clear and retake a point by simply clicking the "Clear Point" button and then repeat the process to retake the point.

Take Point 8

< Back Next > Finish Cancel

When you have taken the desired amount of “As Left” temperature points click the “Next” button to view the “As Received” calibration report. Each temperature probe will appear in its own tab and contains the data for each calibration point along with the coefficients used at the time the points were taken.

Calibration Wizard

"As Left" calibration report

Calibration Report

TSC Model: 2900
TSC Serial Number: 0
Date and Time: 10/24/2017 2:14:12 PM

"As Left" Temperature Calibration
UUT: Chamber Temperature (RTD4)
Standard used: Temperature Standard
Tolerance: ±0.027

The "As Left" calibration report for each item is displayed in the corresponding tabs for review. Each report contains the data for each calibration point and the coefficients applied at the time the point was taken. To save the reports click the "Save Reports" button.

Chamber Temperature Saturation Temperature Exp-Valve Temperature Pre-Saturator Temperature

Save Reports

< Back **Next >** Finish Cancel

Clicking the “Save Reports” button will open a file dialog to save the report. The default file location is ...Documents\Thunder Scientific\2900 ControLog\Reports\. If the report is saved in an Excel format, then each probe will appear in its own tab within the workbook. The user wishes to save in a text-based format then a file for each probe calibrated will be created.

When finished, close the Temperature Calibration window, quit ControLog, and then switch the power OFF. Remove the power cord.

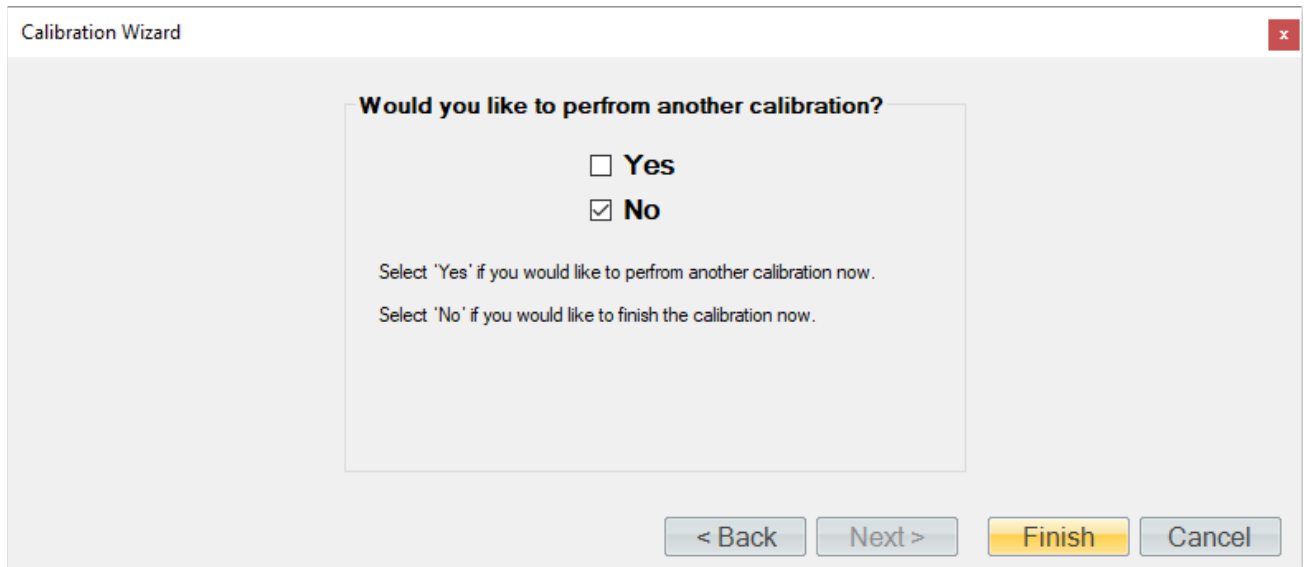

Place the split RTD cover into the frame corners between the chamber foam and frame.

Reinstall all temperature probes making sure they are in the correct positions:

1. Chamber Temperature Probe (RTD4): Feed the probe and cable down through the chamber access port. Using the Long Nose Pliers, grasp the rubber cork and press it into the access port. Replace the access port insulation.
2. Saturation Temperature Probe (RTD1): Insert the Saturation Temperature Probe into the access port fitting until it stops. Using the “Temp Probe Tool”, tighten the captive nut clockwise finger tight only. Replace the access port insulation.
3. Expansion Valve Temperature Probe (RTD3): Insert the Expansion Valve Temperature Probe through the expansion valve insulation and insert the probe into the temp probe fitting. Using the “Temp Probe Tool”, tighten the knurled compression nut clockwise finger tight only. Replace the expansion valve insulation. Replace the expansion valve access cover.
4. Presaturator Temperature Probe (RTD2): Insert the Presaturator Temperature Probe and cable down through the 2900 frame corner. Pull approximately six inches of extra cable then insert the Presaturator Temperature Probe into the thermal well until it bottoms. Insert the cable stay into thermo well to hold probe in place.
5. Replace all console panels.
6. Replace air supply fitting and reconnect air supply.
7. Reconnect power.

6.2 PRESSURE TRANSDUCER CALIBRATION

The pressure calibration procedure is used in conjunction with a precision pressure standard to calibrate the pressure transducers. The calibration calibrates the transducer as part of the system, much in the same way the temperature probes are calibrated. It uses up to five known pressures and all coefficients are calculated automatically by the computer and used to update the system calibration. Calibration reports will be generated for calibrations and can be saved for each of the pressure transducer at the conclusion of each calibration sequence.

Refer to drawings: [18D29901-1](#), [18D29901-3](#), [18D29901-5](#), [18D29901-8](#)

6.2.1 Equipment Required

1. Standard or Reference pressure gauge and or source.
2. #10 Torx
3. 9/16" wrench
4. 3/4" wrench

6.2.2 Calibration Procedure

For safety purposes, perform a [shutdown](#), perform a [shutdown system](#), switch system "POWER" to OFF and remove power cord.

CAUTION!

ALL SYSTEM PRESSURE MUST BE VENTED BEFORE PROCEEDING.

1. Disconnect the air supply line.
2. Using the appropriate tool, remove the left and rear panels from the generator
3. Using the appropriate tools, remove the pressure transducer to be calibrated, leaving it electrically connected to the system.
4. Connect transducer to be calibrated to the reference pressure gauge.

Note: Only one pressure transducer can be calibrated at any given time. Each transducer is operated over a limited range and requires calibration within this range only.

- Saturator Transducer - Calibrate from ambient to 160 PSIA.
- Chamber Transducer - Calibrate from 10 to 17 PSIA.
- Supply Transducer – Calibrate from ambient to 150 PSIG.

CAUTION!

DO NOT ENABLE PRESSURE CONTROL WITH PRESSURE
TRANSDUCERS DISCONNECTED FROM SYSTEM.

From the Units menu tab select the desired pressure units for calibration. Once calibration has begun, the units should not be changed again until the calibration is complete.

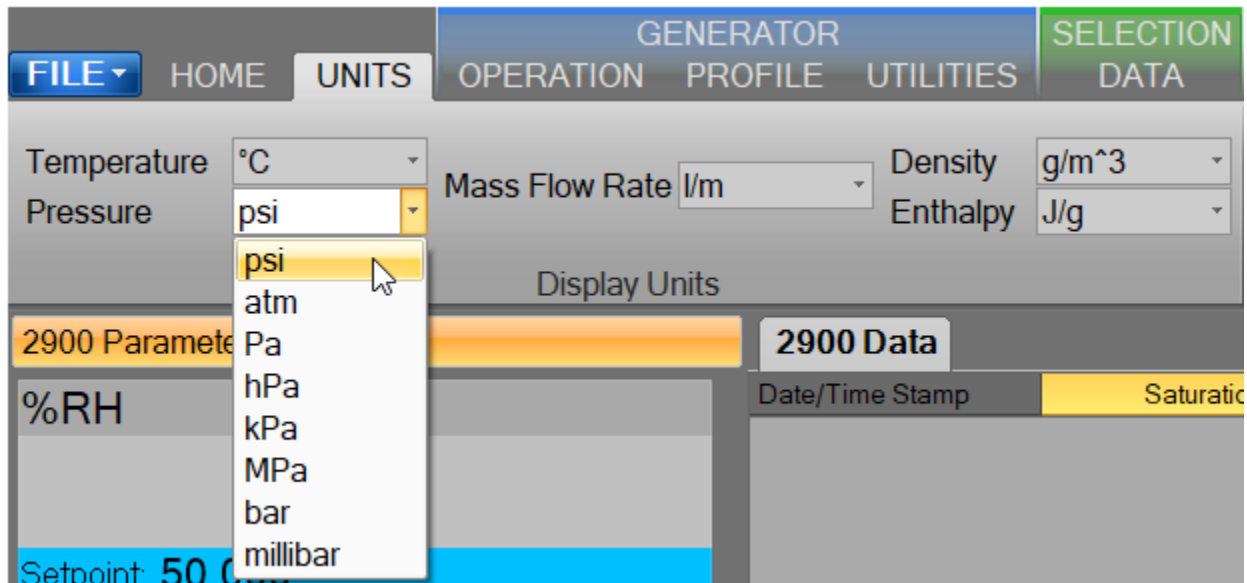

Select Generator Calibration from the Utilities menu tab to open the Calibration Wizard.

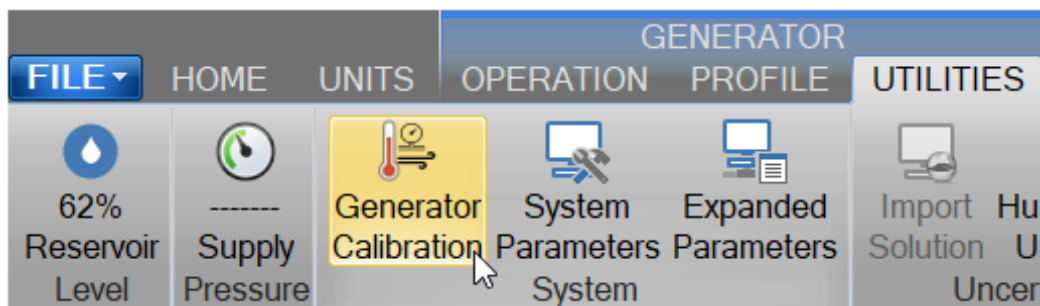

Select, "Take "As Received" points". This will allow the user to take points with the current calibration to determine out of tolerance. After all "As Received" points have been taken the user will be asked whether they want to calculate new calibration coefficients.

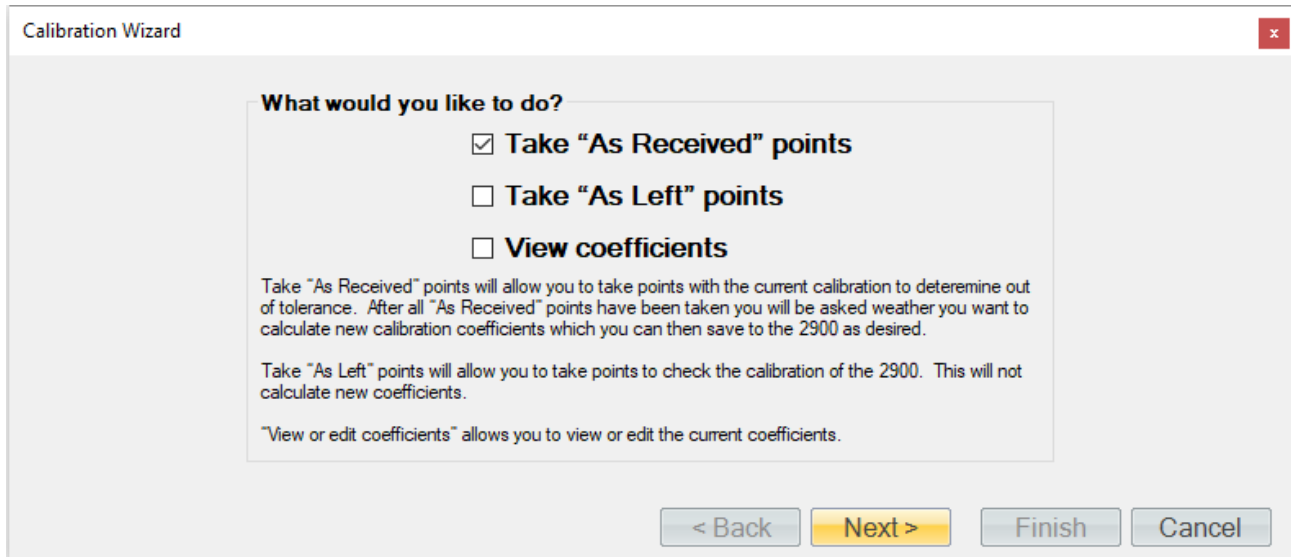

Set the type of calibration to Pressure.

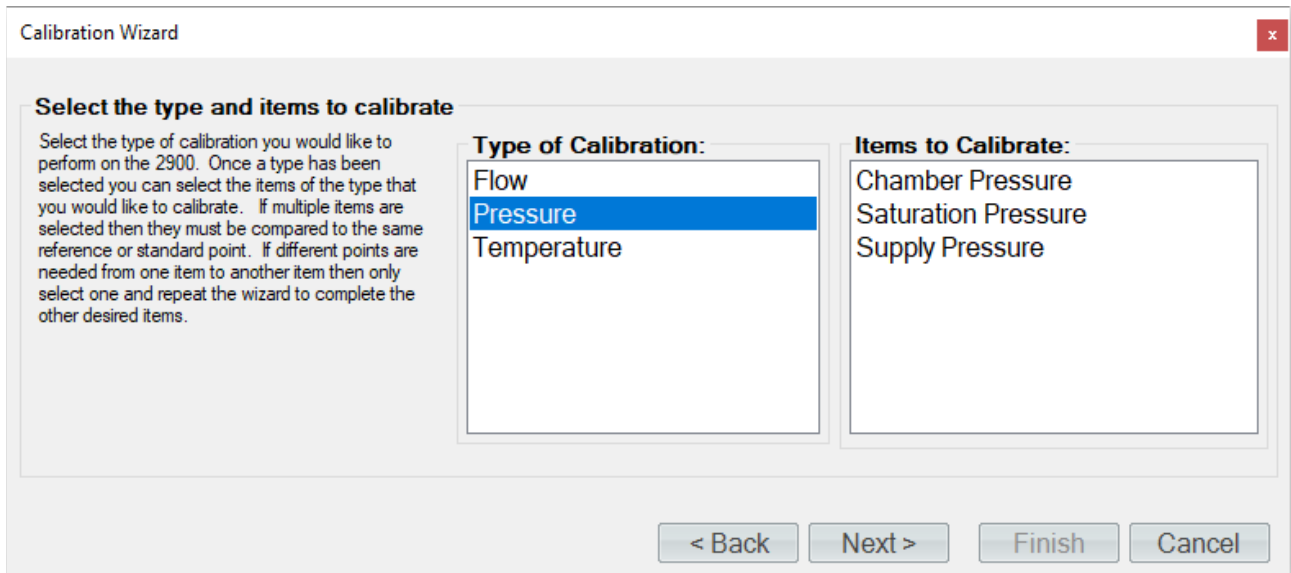

Select the pressure transducer to be calibrated.

Note – Only one pressure transducer can be calibrated at any given time due to the different scaling of the transducers.

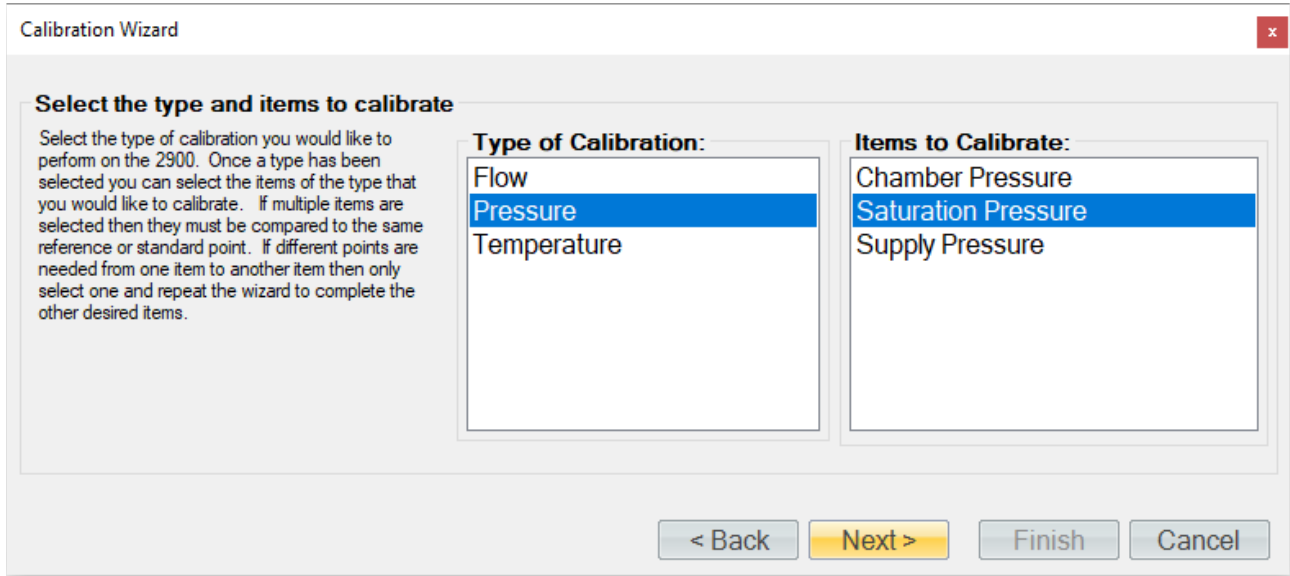

If the pressure standard is a connected device (refer to section [9 Connections](#)), you may select it for the calibration. You can use a single device item with the same calibration type from any connected device. ControLog will automatically record the standard's value during each calibration point. If the standard is not a connected device or if you desire to manually enter the standard's value do not select an item from the list.

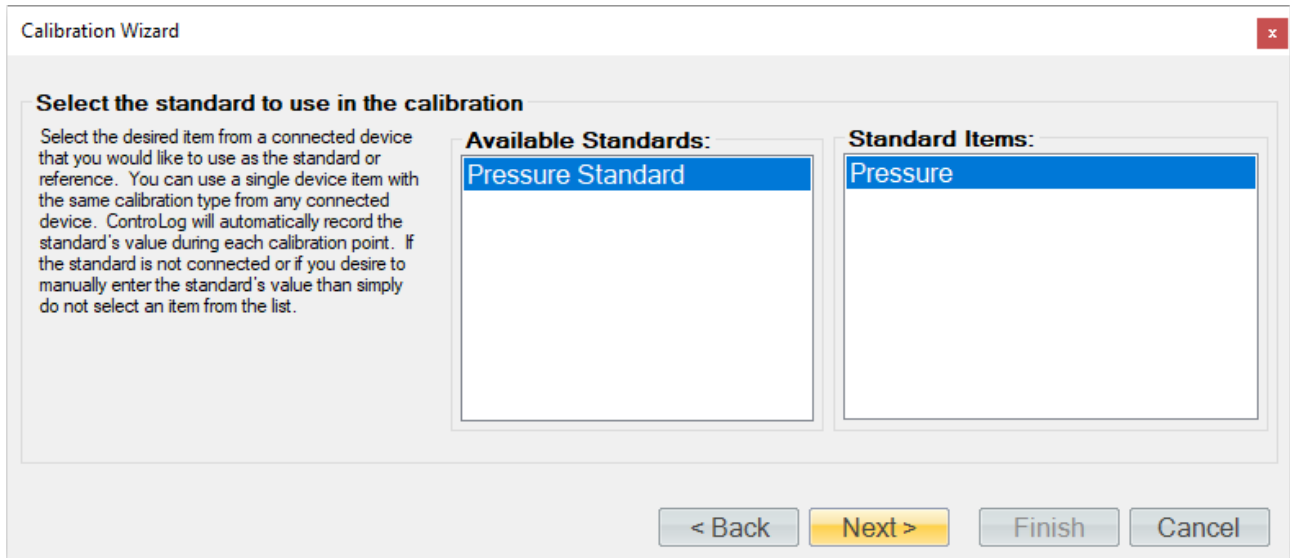

Enter the Name and ID of the standard being used. This information will be populated on the calibration report. Selecting “Next” without entering a Name will result in ControLog giving the standard a generic name.

The screenshot shows a window titled "Calibration Wizard" with a close button in the top right corner. The main content area is titled "Enter the name and ID for the standard". It contains two input fields: "Name:" and "ID:". Below these fields is a descriptive text: "Enter the name and ID for the standard or reference that will be used for this calibration." At the bottom of the window, there are four buttons: "< Back", "Next >" (highlighted in yellow), "Finish", and "Cancel".

Enter the desired calibration tolerance or guard band for the calibration. ControLog will signal the user that a calibration item is out of tolerance based on the value entered below.

The screenshot shows a window titled "Calibration Wizard" with a close button in the top right corner. The main content area is titled "Enter calibration tolerance". It features a text input field with a leading "±" symbol and the value "0.032". Below the input field is a descriptive text: "Enter the desired calibration tolerance or guardband for the calibration. ControLog will signal the user that a calibration item is out of tolerance based on the value entered above." A second paragraph explains: "The tolerance is the allowable variation between the standard or reference and the item being calibrated. This is best thought of as a window based on a minimum and maximum value, the minimum being the standard minus the tolerance and the maximum being the standard plus the tolerance. If the value of the item being calibrated is outside the window then item is considered out of tolerance." At the bottom of the window, there are four buttons: "< Back", "Next >" (highlighted in yellow), "Finish", and "Cancel".

The tolerance is the allowable variation between the standard or reference and the item being calibrated. This is best thought of as a window based on a minimum and maximum value, the minimum being the standard minus the tolerance and the maximum being the standard plus the tolerance. If the value of the item being calibrated is outside the window, then item is considered out of tolerance.

An out of tolerance condition will be indicated by a red circle with an exclamation point  for the out of tolerance transducer in the Error column.

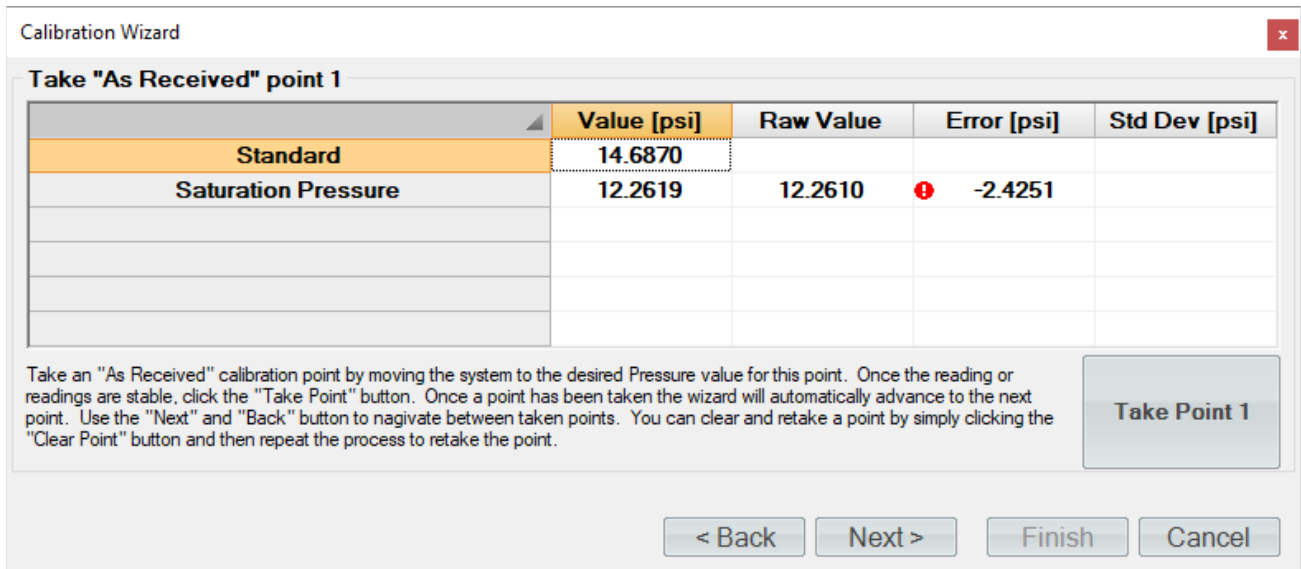

Calibration Wizard

Take "As Received" point 1

	Value [psi]	Raw Value	Error [psi]	Std Dev [psi]
Standard	14.6870			
Saturation Pressure	12.2619	12.2610	 -2.4251	

Take an "As Received" calibration point by moving the system to the desired Pressure value for this point. Once the reading or readings are stable, click the "Take Point" button. Once a point has been taken the wizard will automatically advance to the next point. Use the "Next" and "Back" button to navigate between taken points. You can clear and retake a point by simply clicking the "Clear Point" button and then repeat the process to retake the point.

Take Point 1

< Back Next > Finish Cancel

Enter the sample size used to perform the standard deviation calculation. The sample size is the given time that ControLog will use to determine which data points to use to determine the standard deviation of each probe.

Note - *The number of points used will be based on the data storage rate you have selected along with the desired sample size. For example, if the data storage rate is every 10 seconds then a sample size of 1 minute will result in 10 points being used to calculate the standard deviation.*

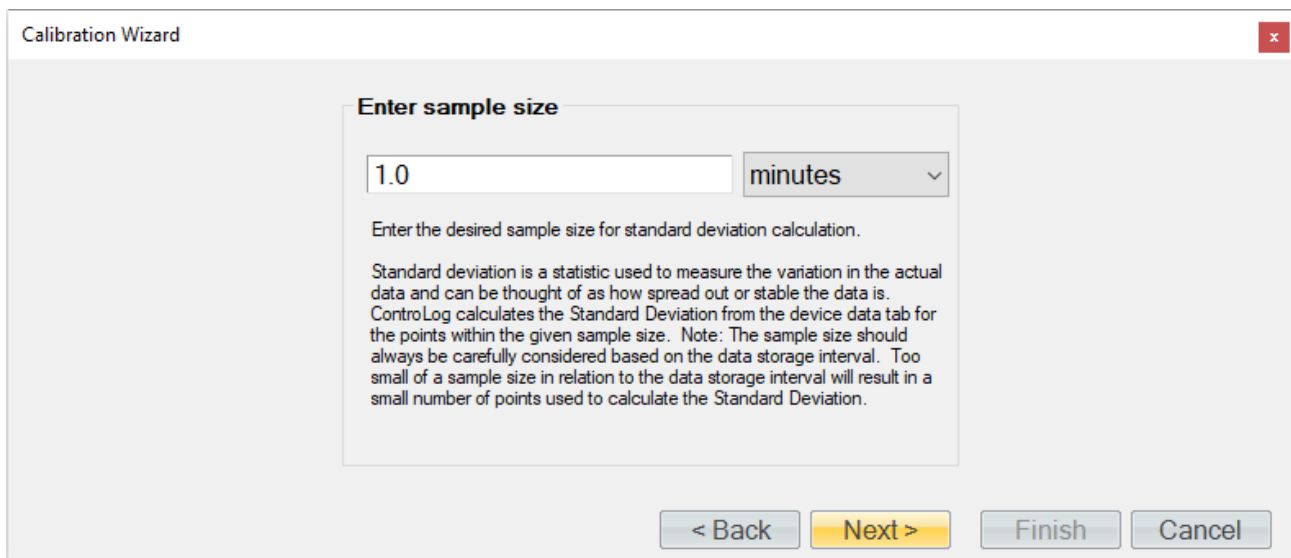

Calibration Wizard

Enter sample size

1.0 minutes

Enter the desired sample size for standard deviation calculation.

Standard deviation is a statistic used to measure the variation in the actual data and can be thought of as how spread out or stable the data is. ControLog calculates the Standard Deviation from the device data tab for the points within the given sample size. Note: The sample size should always be carefully considered based on the data storage interval. Too small of a sample size in relation to the data storage interval will result in a small number of points used to calculate the Standard Deviation.

< Back Next > Finish Cancel

Select the number of points you would like to take for this “As Received” calibration. Each point defines what the “true” value is at a given point based on the standard or reference value. The number of points determines the degree of the polynomial used to align or correct the generator with the standard or reference.

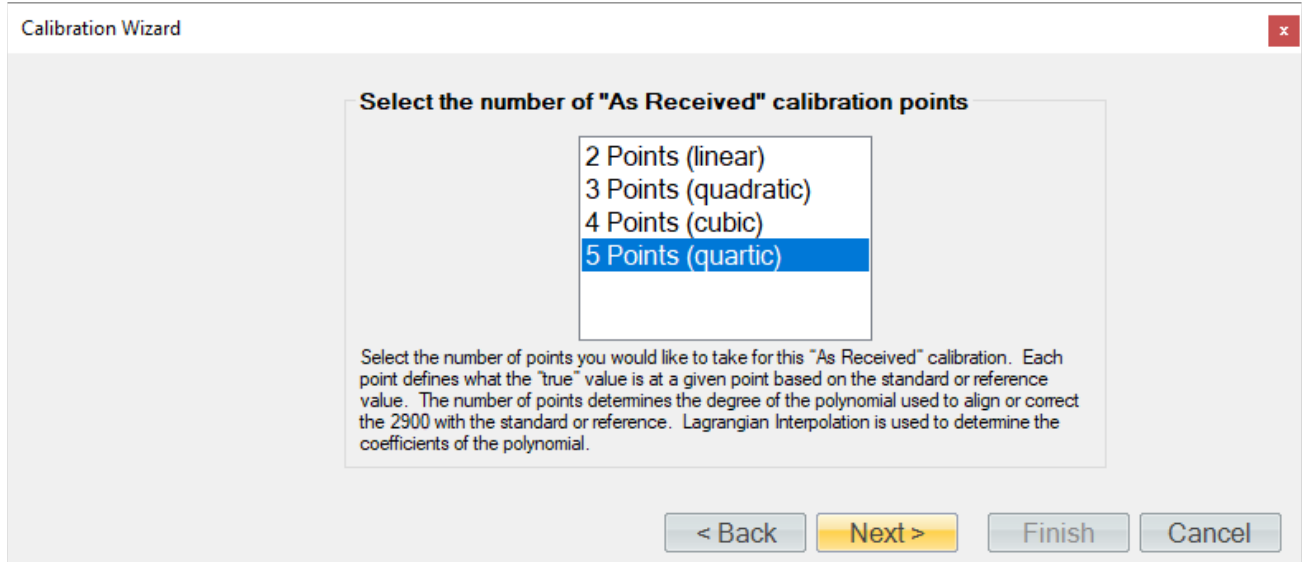

Note - Each transducer is operated at or above ambient pressure, requiring calibration between ambient and full scale only. There is no need for below ambient testing or calibration.

Note – The specific points can be different than those used in the example. For this example, the points, Ambient, 40, 80, 120, 160 were used, but it could have also been Ambient, 25, 50, 100, 160. Just use best metrology practices when determining which the points to take.

Using the pressure standard, generate and measure an ambient pressure. If the standard is not a connected device, then ControLog will ask for the value before taking the point. You can also enter a standard or reference value before taking a point by clicking the cell in the “Standard” row and “Value” column. This is useful for seeing error values before a point is taken.

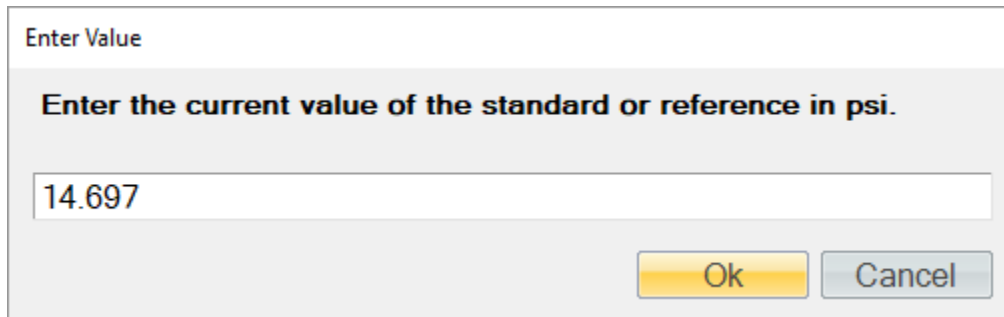

Once the reading is stable, click the “Take Point” button. Once a point has been taken, the wizard will automatically advance to the next point.

Calibration Wizard x

Take "As Received" point 1

	Value [psi]	Raw Value	Error [psi]	Std Dev [psi]
Standard	14.6970			
Saturation Pressure	14.6965	14.6968	-0.0005	0.0001

Take an "As Received" calibration point by moving the system to the desired Pressure value for this point. Once the reading or readings are stable, click the "Take Point" button. Once a point has been taken the wizard will automatically advance to the next point. Use the "Next" and "Back" button to navigate between taken points. You can clear and retake a point by simply clicking the "Clear Point" button and then repeat the process to retake the point.

Take Point 1

Tip - Use the “Next” and “Back” button to navigate between taken points. You can clear and retake a point by simply clicking the “Clear Point” button and then repeat the process to retake the point.

Calibration Wizard x

"As Received" Calibration point 1

	Value [psi]	Raw Value	Error [psi]	Std Dev [psi]
Standard	14.6970			
Saturation Pressure	14.6965	14.6968	-0.0005	0.0001

Take an "As Received" calibration point by moving the system to the desired Pressure value for this point. Once the reading or readings are stable, click the "Take Point" button. Once a point has been taken the wizard will automatically advance to the next point. Use the "Next" and "Back" button to navigate between taken points. You can clear and retake a point by simply clicking the "Clear Point" button and then repeat the process to retake the point.

Clear Point 1

Using the pressure standard, generate and measure the next pressure point (40 psi). Once the readings are stable, enter the standards value and click the "Take Point" button.

Calibration Wizard ✖

Take "As Received" point 2

	Value [psi]	Raw Value	Error [psi]	Std Dev [psi]
Standard	40.0000			
Saturation Pressure	40.0002	40.0007	0.0002	0.0001

Take an "As Received" calibration point by moving the system to the desired Pressure value for this point. Once the reading or readings are stable, click the "Take Point" button. Once a point has been taken the wizard will automatically advance to the next point. Use the "Next" and "Back" button to navigate between taken points. You can clear and retake a point by simply clicking the "Clear Point" button and then repeat the process to retake the point.

Take Point 2

Using the pressure standard, generate and measure the next pressure point (80 psi). Once the readings are stable, enter the standards value and click the "Take Point" button.

Calibration Wizard ✖

Take "As Received" point 3

	Value [psi]	Raw Value	Error [psi]	Std Dev [psi]
Standard	80.0000			
Saturation Pressure	80.0000	80.0006	0.0000	0.0000

Take an "As Received" calibration point by moving the system to the desired Pressure value for this point. Once the reading or readings are stable, click the "Take Point" button. Once a point has been taken the wizard will automatically advance to the next point. Use the "Next" and "Back" button to navigate between taken points. You can clear and retake a point by simply clicking the "Clear Point" button and then repeat the process to retake the point.

Take Point 3

Using the pressure standard, generate and measure the next pressure point (120 psi). Once the readings are stable, enter the standards value and click the "Take Point" button.

Calibration Wizard ✕

Take "As Received" point 4

	Value [psi]	Raw Value	Error [psi]	Std Dev [psi]
Standard	120.0000			
Saturation Pressure	120.0001	119.9994	0.0001	0.0000

Take an "As Received" calibration point by moving the system to the desired Pressure value for this point. Once the reading or readings are stable, click the "Take Point" button. Once a point has been taken the wizard will automatically advance to the next point. Use the "Next" and "Back" button to navigate between taken points. You can clear and retake a point by simply clicking the "Clear Point" button and then repeat the process to retake the point.

Take Point 4

Using the pressure standard, generate and measure the last pressure point (160 psi). Once the readings are stable, enter the standards value and click the "Take Point" button.

Calibration Wizard ✕

Take "As Received" point 5

	Value [psi]	Raw Value	Error [psi]	Std Dev [psi]
Standard	160.0000			
Saturation Pressure	159.9996	159.9985	-0.0004	0.0000

Take an "As Received" calibration point by moving the system to the desired Pressure value for this point. Once the reading or readings are stable, click the "Take Point" button. Once a point has been taken the wizard will automatically advance to the next point. Use the "Next" and "Back" button to navigate between taken points. You can clear and retake a point by simply clicking the "Clear Point" button and then repeat the process to retake the point.

Take Point 5

When all pressure points have been entered, ControLog will advance to the “As Received” calibration report. The transducer will appear in its own tab and contains the data for each calibration point along with the coefficients used at the time the points were taken.

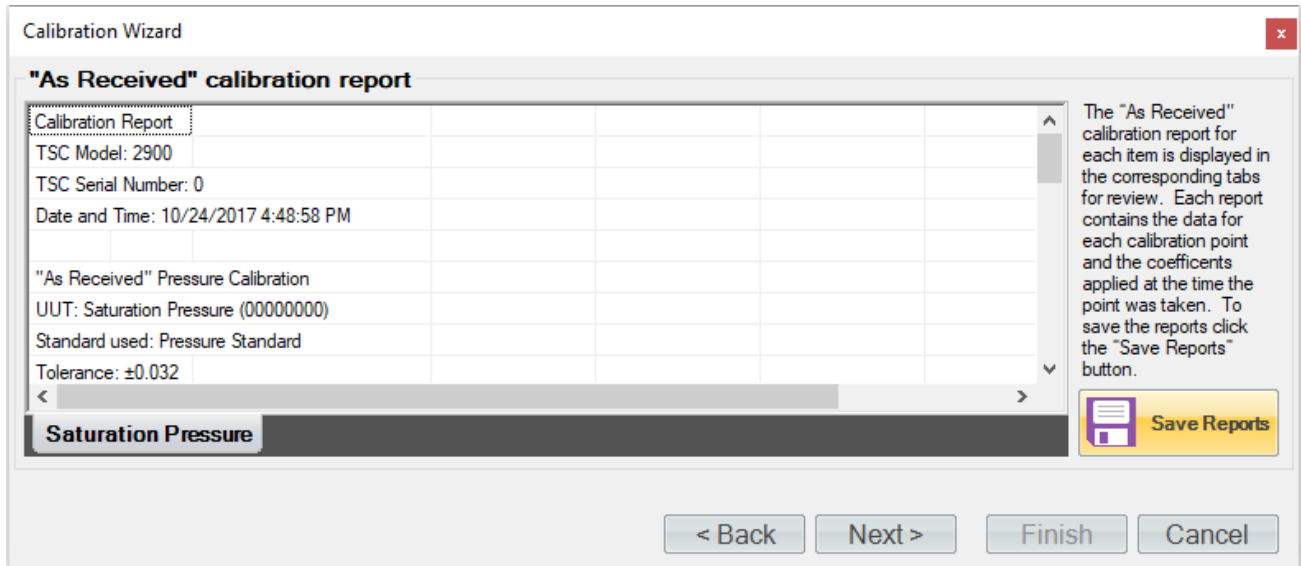

Clicking the “Save Reports” button will open a file dialog to save the report. The default file location is ...Documents\Thunder Scientific\2900 ControLog\Reports\.

Clicking “Next” will ask the user if they want to calculate new coefficients using the as received data points just taken.

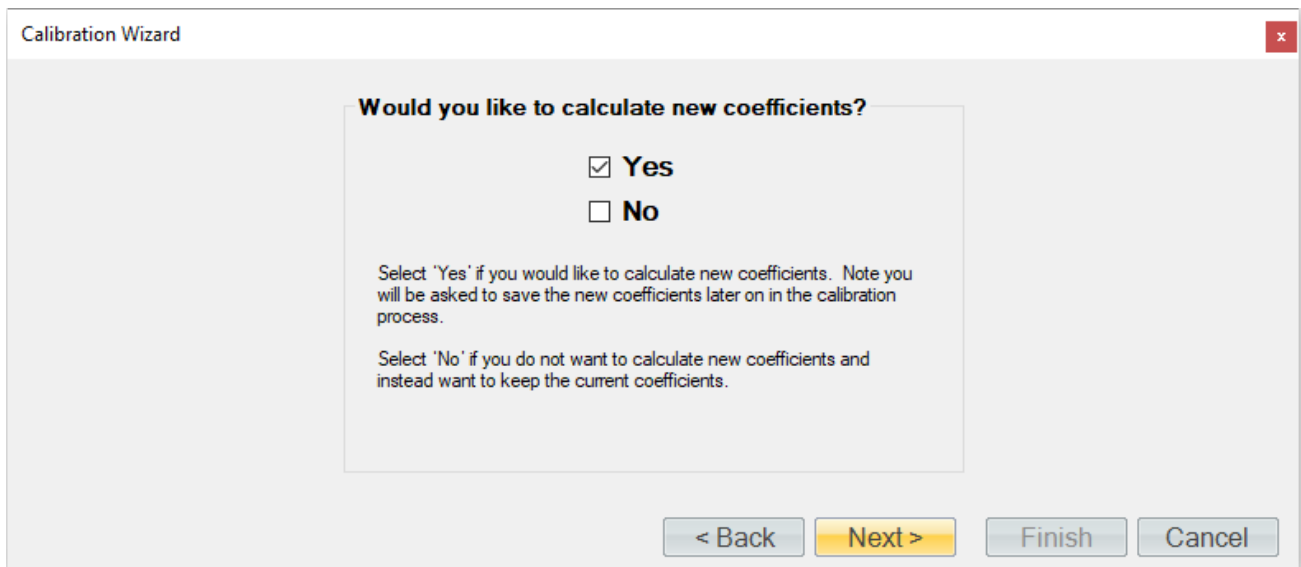

If the user selected to calculate new coefficients, they will be calculated and displayed. If any problem calculating the coefficient occurs, ControLog will issue a message telling the user that the coefficients could not be calculated.

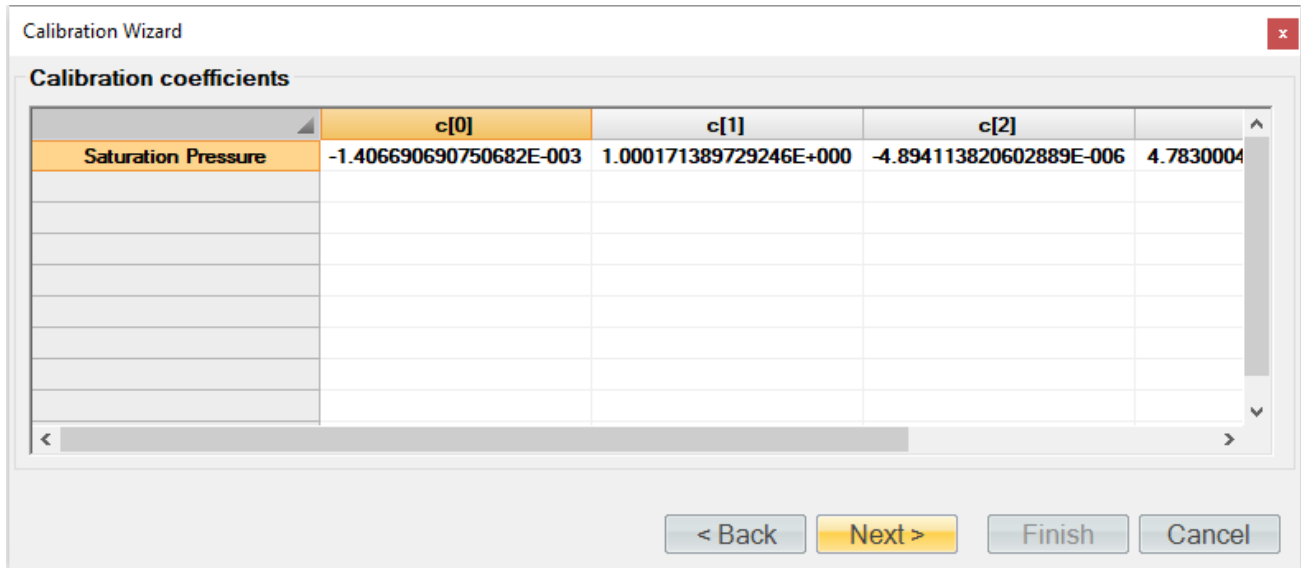

Next, the user will be asked to save the new coefficients to the system. Selecting "Yes" will result in the current coefficient being over-written by the newly calculated coefficients.

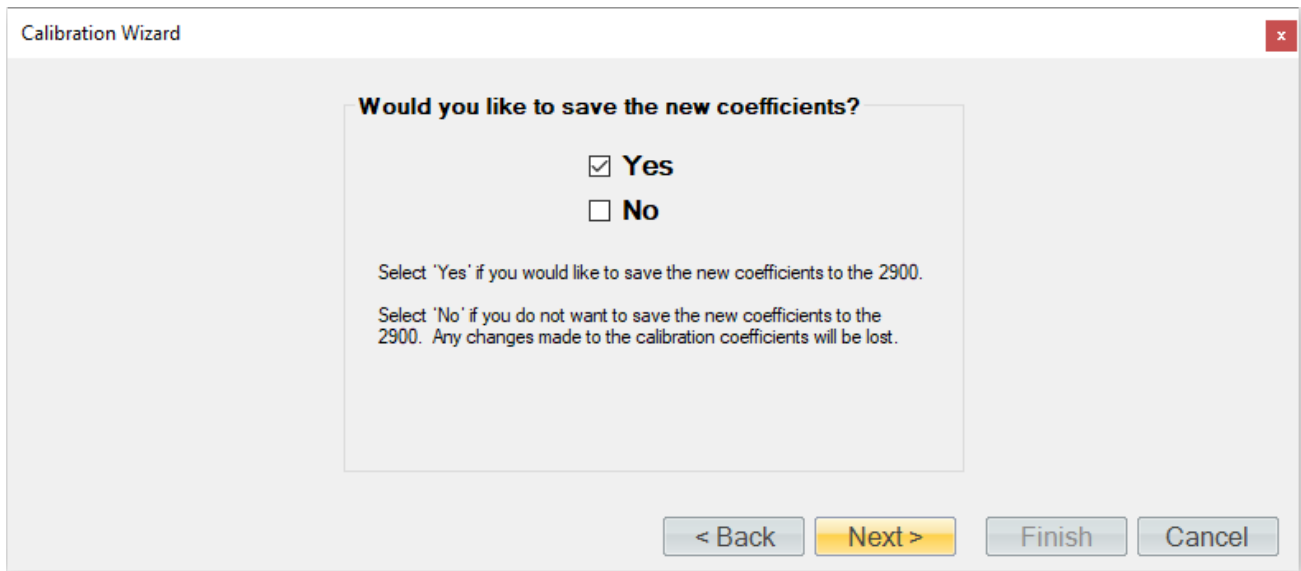

Next, the user can view and save the calibration coefficients report for the transducer.

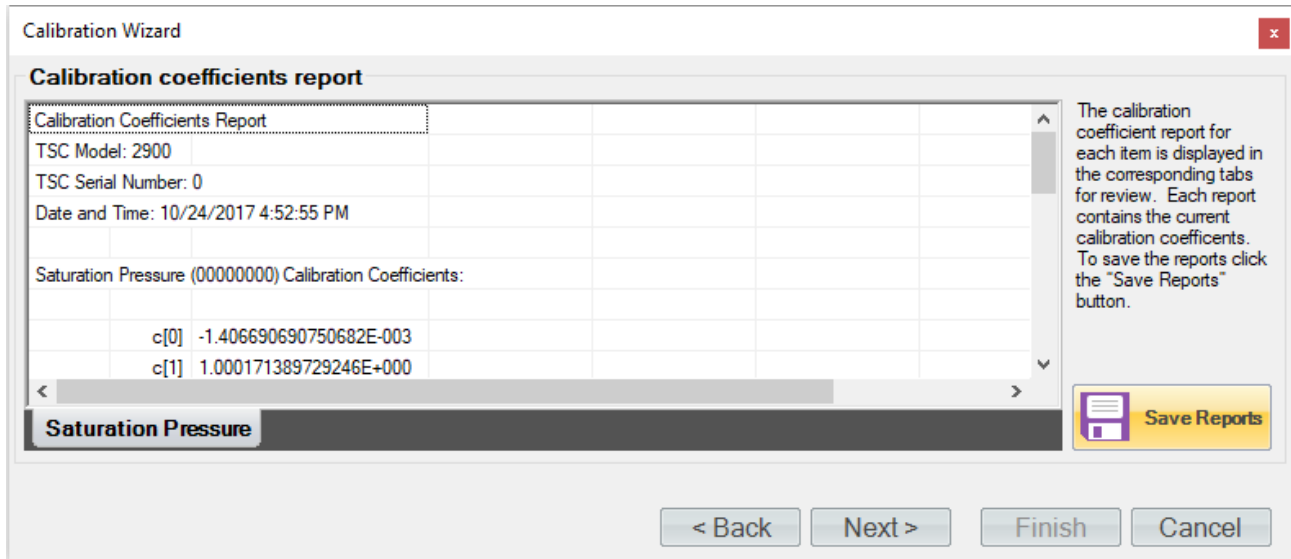

Next, the user can complete the calibration or can choose to take "As Left" points.

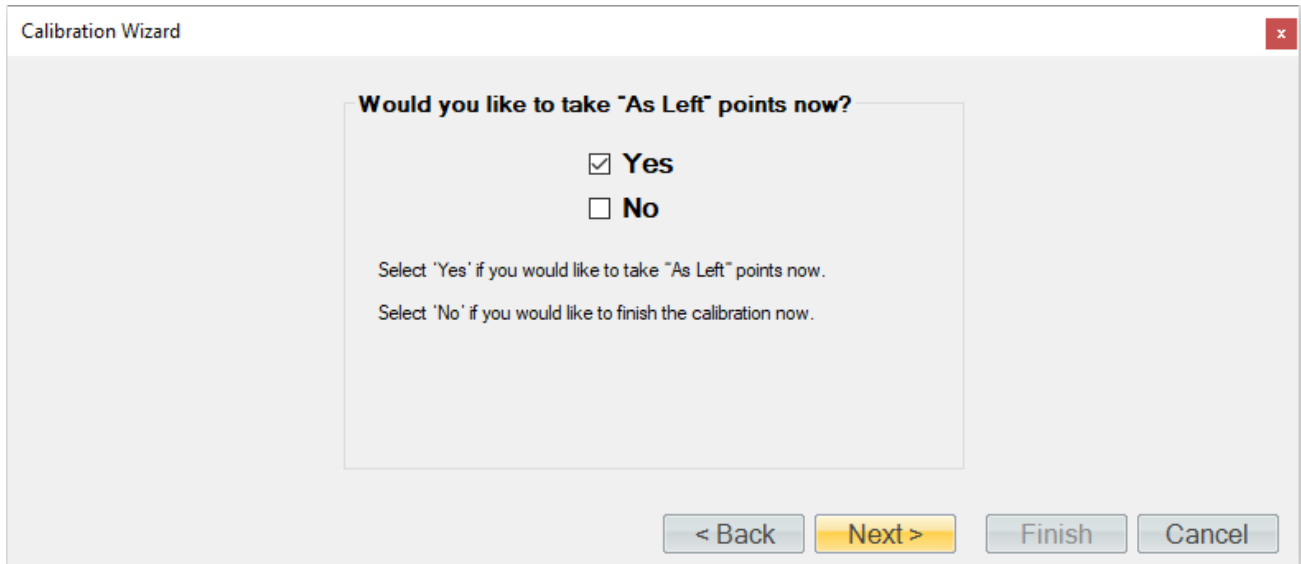

ControLog allows the user to take as many “As Left” points as they would like. In this example we will check every 25 psi starting at 160 psi and ending at atmospheric pressure. If the standard is not a connected device, then ControLog will ask for the value before taking the point. You can also enter a standard or reference value before taking a point by clicking the cell in the “Standard” row and “Value” column. This is useful for seeing error values before a point is taken.

Enter Value

Enter the current value of the standard or reference in psi.

160.0

Once the readings are stable, enter the standards value and click the “Take Point” button. Once a point has been taken, the wizard will automatically advance to the next point.

Calibration Wizard x

Take "As Left" point 1

	Value [psi]	Raw Value	Error [psi]	Std Dev [psi]
Standard	160.0000			
Saturation Pressure	159.9992	159.9995	-0.0008	0.0001

Take an "As Left" calibration point by moving the system to the desired Pressure value for this point. Once the reading or readings are stable, click the "Take Point" button. Once a point has been taken the wizard will automatically advance to the next point. Use the "Next" and "Back" button to navigate between taken points. You can clear and retake a point by simply clicking the "Clear Point" button and then repeat the process to retake the point.

Tip - Use the “Next” and “Back” button to navigate between taken points. You can clear and retake a point by simply clicking the “Clear Point” button and then repeat the process to retake the point.

Calibration Wizard x

"As Left" Calibration point 1

Standard	Value [psi]	Raw Value	Error [psi]	Std Dev [psi]
Standard	160.0000			
Saturation Pressure	159.9992	159.9995	-0.0008	0.0001

Take an "As Left" calibration point by moving the system to the desired Pressure value for this point. Once the reading or readings are stable, click the "Take Point" button. Once a point has been taken the wizard will automatically advance to the next point. Use the "Next" and "Back" button to navigate between taken points. You can clear and retake a point by simply clicking the "Clear Point" button and then repeat the process to retake the point.

Clear Point 1

Using the pressure standard, generate and measure the next pressure point (135 psi). Once the readings are stable, enter the standards value and click the “Take Point” button.

Calibration Wizard x

Take "As Left" point 2

Standard	Value [psi]	Raw Value	Error [psi]	Std Dev [psi]
Standard	135.0000			
Saturation Pressure	135.0001	134.9985	0.0001	0.0001

Take an "As Left" calibration point by moving the system to the desired Pressure value for this point. Once the reading or readings are stable, click the "Take Point" button. Once a point has been taken the wizard will automatically advance to the next point. Use the "Next" and "Back" button to navigate between taken points. You can clear and retake a point by simply clicking the "Clear Point" button and then repeat the process to retake the point.

Take Point 2

Using the pressure standard, generate and measure the next pressure point (110 psi). Once the readings are stable, enter the standards value and click the "Take Point" button.

Calibration Wizard x

Take "As Left" point 3

	Value [psi]	Raw Value	Error [psi]	Std Dev [psi]
Standard	110.0000			
Saturation Pressure	110.0000	109.9985	0.0000	0.0004

Take an "As Left" calibration point by moving the system to the desired Pressure value for this point. Once the reading or readings are stable, click the "Take Point" button. Once a point has been taken the wizard will automatically advance to the next point. Use the "Next" and "Back" button to navigate between taken points. You can clear and retake a point by simply clicking the "Clear Point" button and then repeat the process to retake the point.

Take Point 3

Using the pressure standard, generate and measure the next pressure point (85 psi). Once the readings are stable, enter the standards value and click the "Take Point" button.

Calibration Wizard x

Take "As Left" point 4

	Value [psi]	Raw Value	Error [psi]	Std Dev [psi]
Standard	85.0000			
Saturation Pressure	85.0000	85.0005	0.0000	0.0002

Take an "As Left" calibration point by moving the system to the desired Pressure value for this point. Once the reading or readings are stable, click the "Take Point" button. Once a point has been taken the wizard will automatically advance to the next point. Use the "Next" and "Back" button to navigate between taken points. You can clear and retake a point by simply clicking the "Clear Point" button and then repeat the process to retake the point.

Take Point 4

Using the pressure standard, generate and measure the next pressure point (60 psi). Once the readings are stable, enter the standards value and click the "Take Point" button.

Calibration Wizard ✖

Take "As Left" point 5

	Value [psi]	Raw Value	Error [psi]	Std Dev [psi]
Standard	60.0000			
Saturation Pressure	60.0002	60.0005	0.0002	0.0001

Take an "As Left" calibration point by moving the system to the desired Pressure value for this point. Once the reading or readings are stable, click the "Take Point" button. Once a point has been taken the wizard will automatically advance to the next point. Use the "Next" and "Back" button to navigate between taken points. You can clear and retake a point by simply clicking the "Clear Point" button and then repeat the process to retake the point.

Take Point 5

Using the pressure standard, generate and measure the next pressure point (35 psi). Once the readings are stable, enter the standards value and click the "Take Point" button.

Calibration Wizard ✖

Take "As Left" point 6

	Value [psi]	Raw Value	Error [psi]	Std Dev [psi]
Standard	35.0000			
Saturation Pressure	34.9999	34.9995	-0.0001	0.0001

Take an "As Left" calibration point by moving the system to the desired Pressure value for this point. Once the reading or readings are stable, click the "Take Point" button. Once a point has been taken the wizard will automatically advance to the next point. Use the "Next" and "Back" button to navigate between taken points. You can clear and retake a point by simply clicking the "Clear Point" button and then repeat the process to retake the point.

Take Point 6

Using the pressure standard, generate and measure the last pressure point (atmospheric pressure). Once the readings are stable, enter the standards value and click the “Take Point” button.

Calibration Wizard

Take "As Left" point 7

	Value [psi]	Raw Value	Error [psi]	Std Dev [psi]
Standard	14.6970			
Saturation Pressure	14.6970	14.6962	0.0000	0.0001

Take an "As Left" calibration point by moving the system to the desired Pressure value for this point. Once the reading or readings are stable, click the "Take Point" button. Once a point has been taken the wizard will automatically advance to the next point. Use the "Next" and "Back" button to navigate between taken points. You can clear and retake a point by simply clicking the "Clear Point" button and then repeat the process to retake the point.

Take Point 7

< Back Next > Finish Cancel

When you have taken the desired amount of “As Left” temperature points, click the “Next” button to view the “As Received” calibration report. Each transducer will appear in its own tab and contains the data for each calibration point along with the coefficients used at the time the points were taken.

Calibration Wizard

"As Left" calibration report

Calibration Report					
TSC Model: 2900					
TSC Serial Number: 0					
Date and Time: 10/24/2017 5:27:24 PM					
"As Left" Pressure Calibration					
UUT: Saturation Pressure (00000000)					
Standard used: Pressure Standard					
Tolerance: ±0.032					
< _____ >					
Saturation Pressure					

The "As Left" calibration report for each item is displayed in the corresponding tabs for review. Each report contains the data for each calibration point and the coefficients applied at the time the point was taken. To save the reports click the "Save Reports" button.

 **Save Reports**

< Back Next > Finish Cancel

Clicking the “Save Reports” button will open a file dialog to save the report. The default file location is ...Documents\Thunder Scientific\2900 ControLog\Reports\.

Repeat this same procedure for each transducer to calibrate them to their specific range.

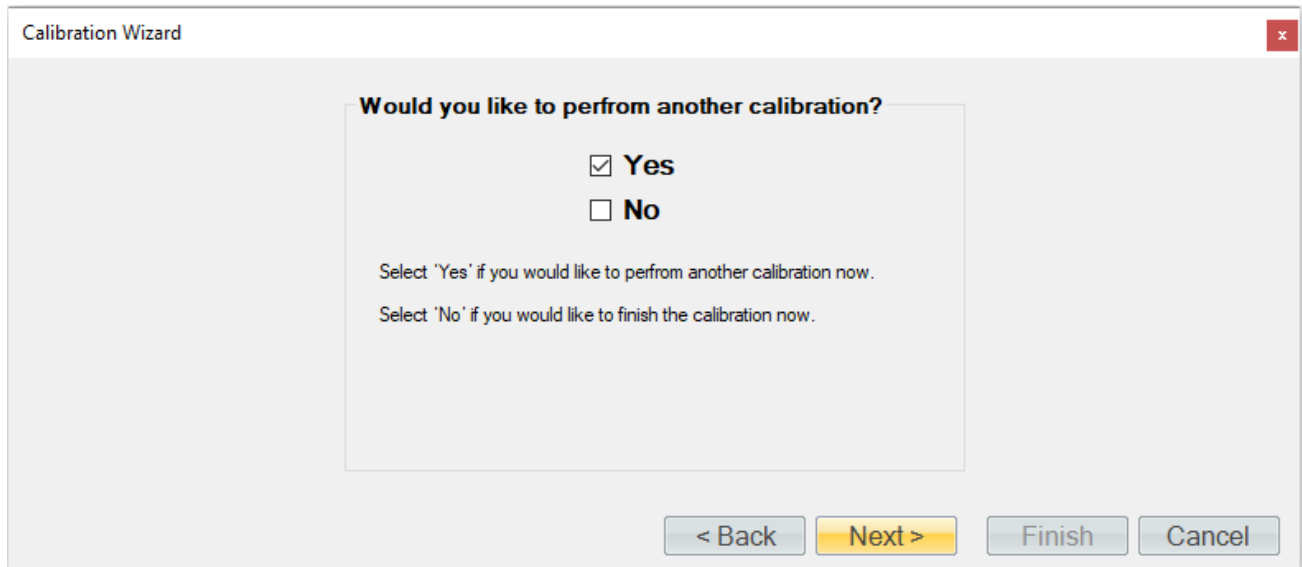

Reinstall the pressure transducer in the system:

- After the pressure transducer has been calibrated, close the Pressure Calibration window and reinstall the pressure transducer, tightening nut 1/8 turn past finger tight.
- Repeat 6.2.2 "Calibration Procedure" for the next transducer.
- Replace console panels when all pressure transducer calibrations have been performed and the transducers have been reinstalled.

6.2.3 Supply Pressure

The supply pressure, while indicated on the screen, is not critical to the accuracy of the generated humidity and is not used in the humidity calculations. Therefore, supply pressure calibration requirements depend upon the needs of the user. The procedure to calibrate the supply pressure is the same as the previous pressure calibration procedure. For more details refer to section [6.2.2 Calibration Procedure](#).

Note – *The supply pressure transducer must be calibrated in gauge pressure.*

6.3 MASS FLOW METER CALIBRATION

The mass flow rate measurement, while indicated on the screen, is not critical to the accuracy of the generated humidity and is not used in the humidity calculations. Therefore, flow calibration requirements depend upon the needs of the user.

6.3.1 Equipment Required

1. Standard or Reference flow meter.

6.3.2 Calibration Procedure

Connect the reference flow meter to the gas supply inlet inside the test chamber.

From the Units menu tab select the desired mass flow rate units for calibration. Once calibration has begun, the units should not be changed again until the calibration is complete.

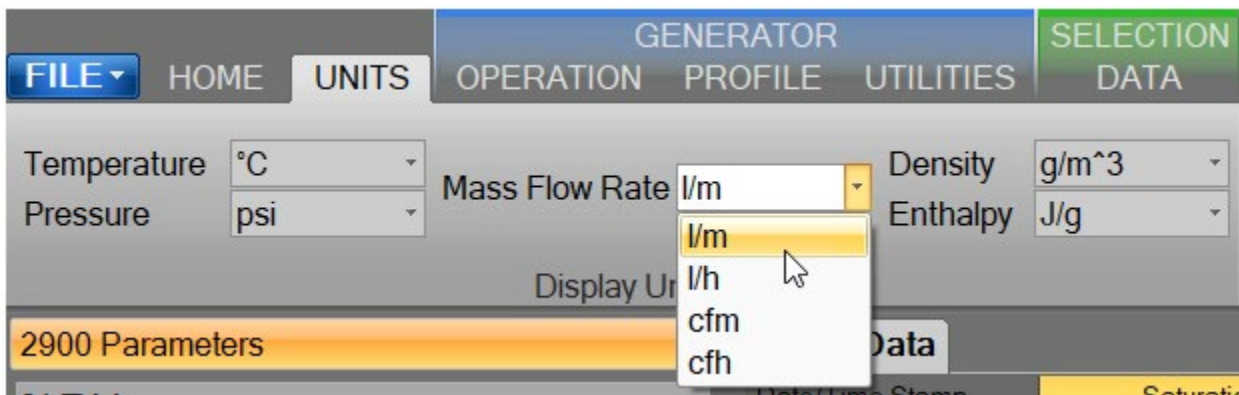

Select Generator Calibration from the Utilities menu tab to open the Calibration Wizard.

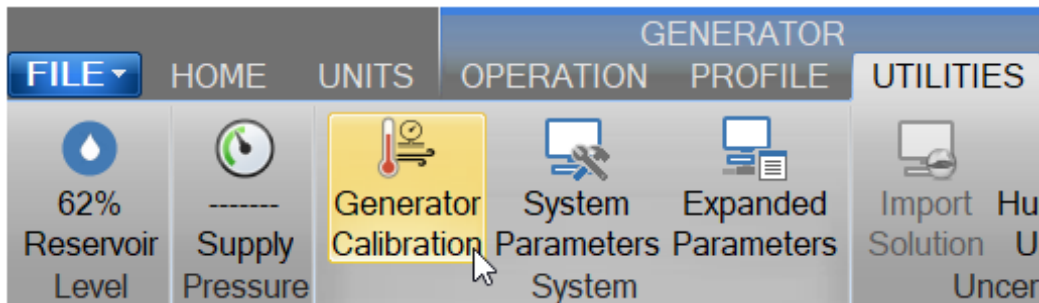

Select, "Take "As Received" points". This will allow the user to take points with the current calibration to determine out of tolerance. After all "As Received" points have been taken the user will be asked whether they want to calculate new calibration coefficients.

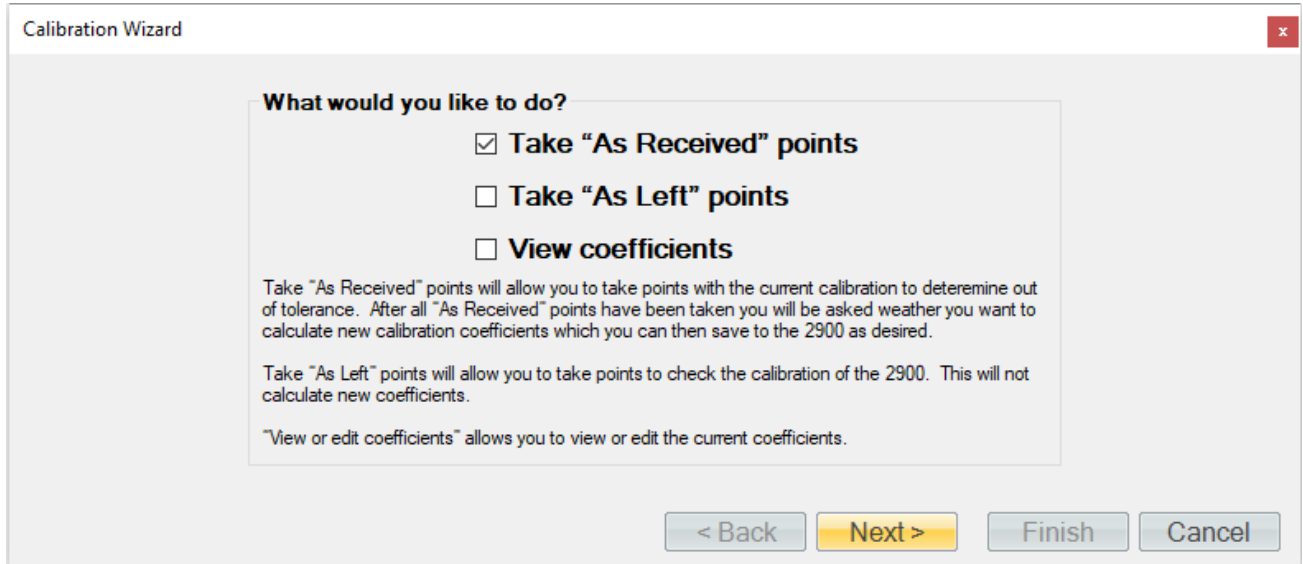

Set the type of calibration to Flow and select the Mass Flow Rate as the item to calibrate.

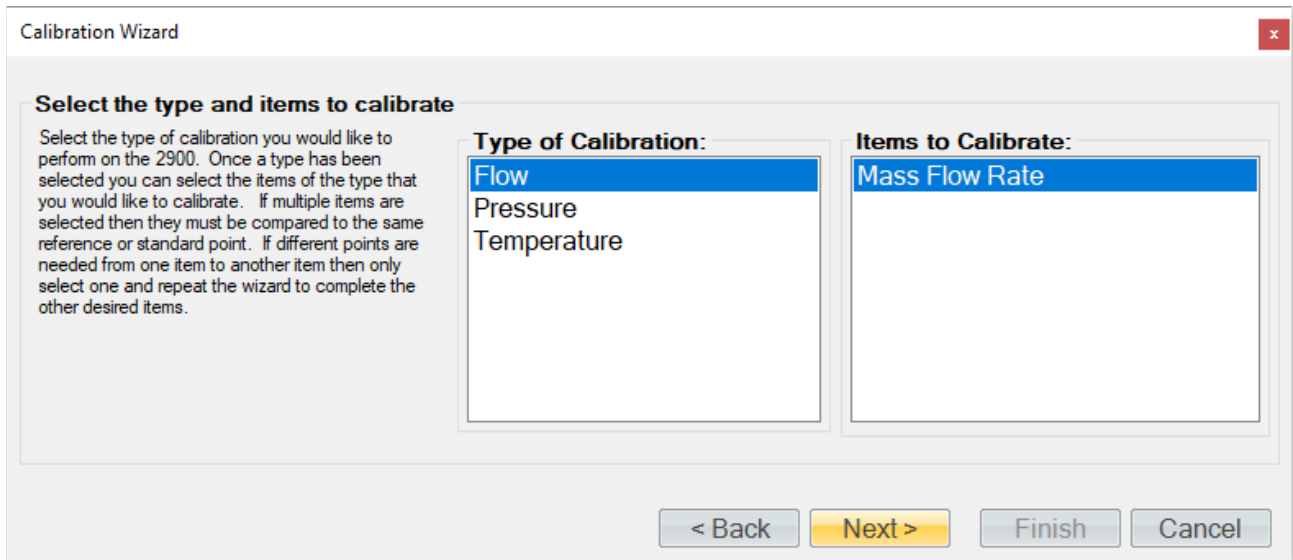

If the mass flow rate standard is a connected device (refer to section [9 Connections](#)), you may select it for the calibration. You can use a single device item with the same calibration type from any connected device. ControLog will automatically record the standard's value during each calibration point. If the standard is not a connected device or if you desire to manually enter the standard's value do not select an item from the list.

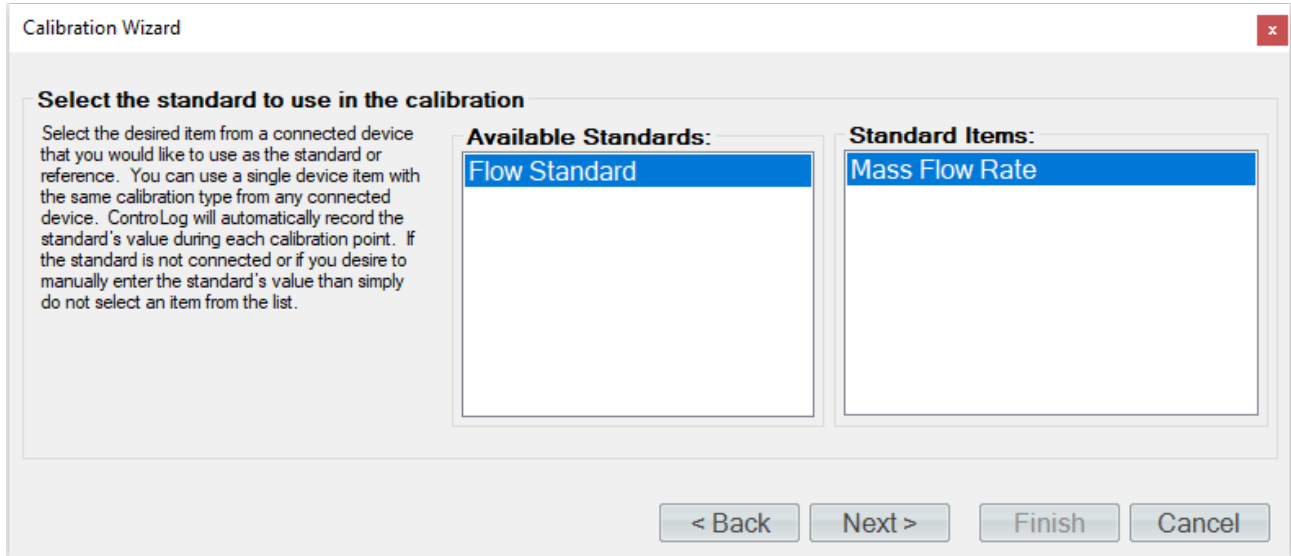

Enter the Name and ID of the standard being used. This information will be populated on the calibration report. Selecting "Next" without entering a Name will result in ControLog giving the standard a generic name.

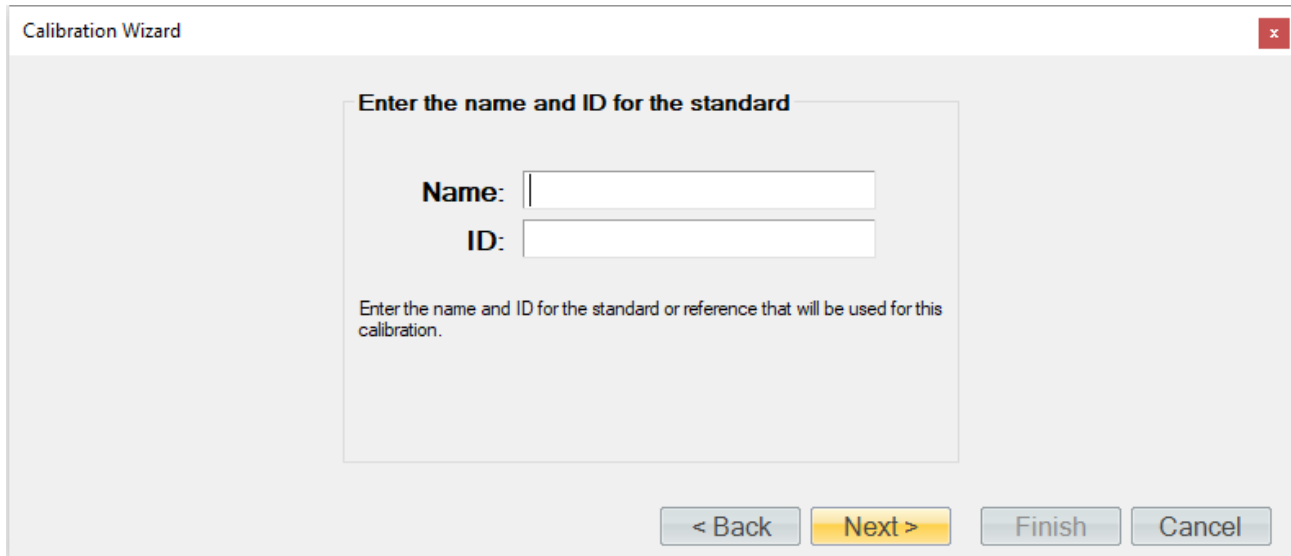

Enter the desired calibration tolerance or guard band for the calibration. ControLog will signal the user that a calibration item is out of tolerance based on the value entered above.

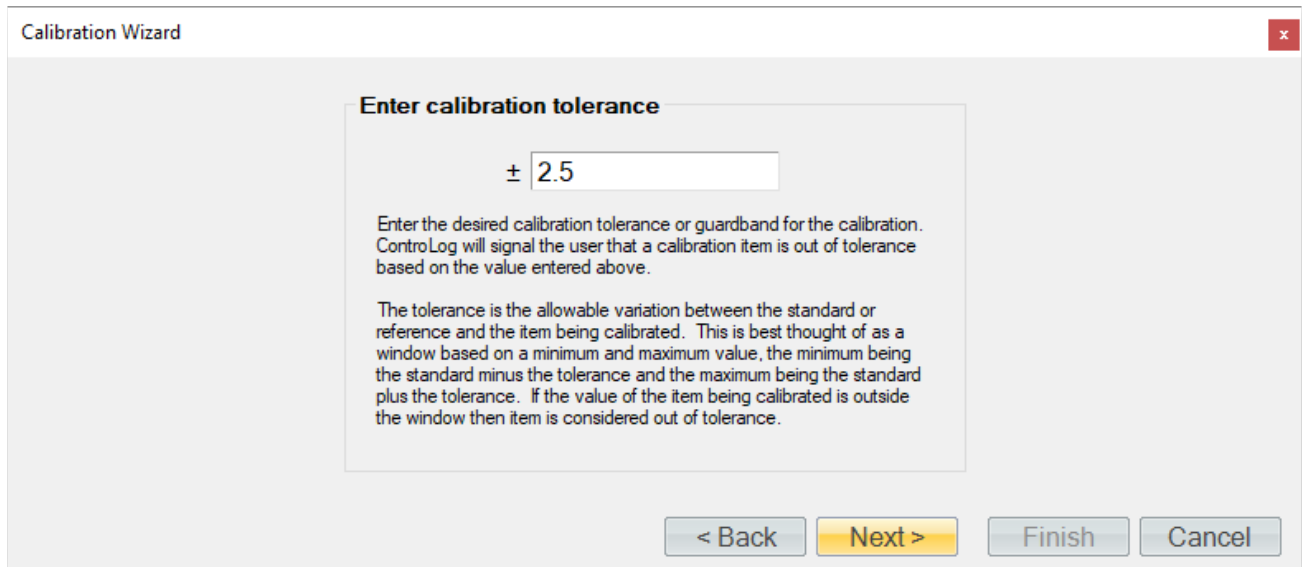

The tolerance is the allowable variation between the standard or reference and the item being calibrated. This is best thought of as a window based on a minimum and maximum value, the minimum being the standard minus the tolerance and the maximum being the standard plus the tolerance. If the value of the item being calibrated is outside the window, then item is considered out of tolerance.

An out of tolerance condition will be indicated by a red circle with an explanation point  for the out of tolerance transducer in the Error column.

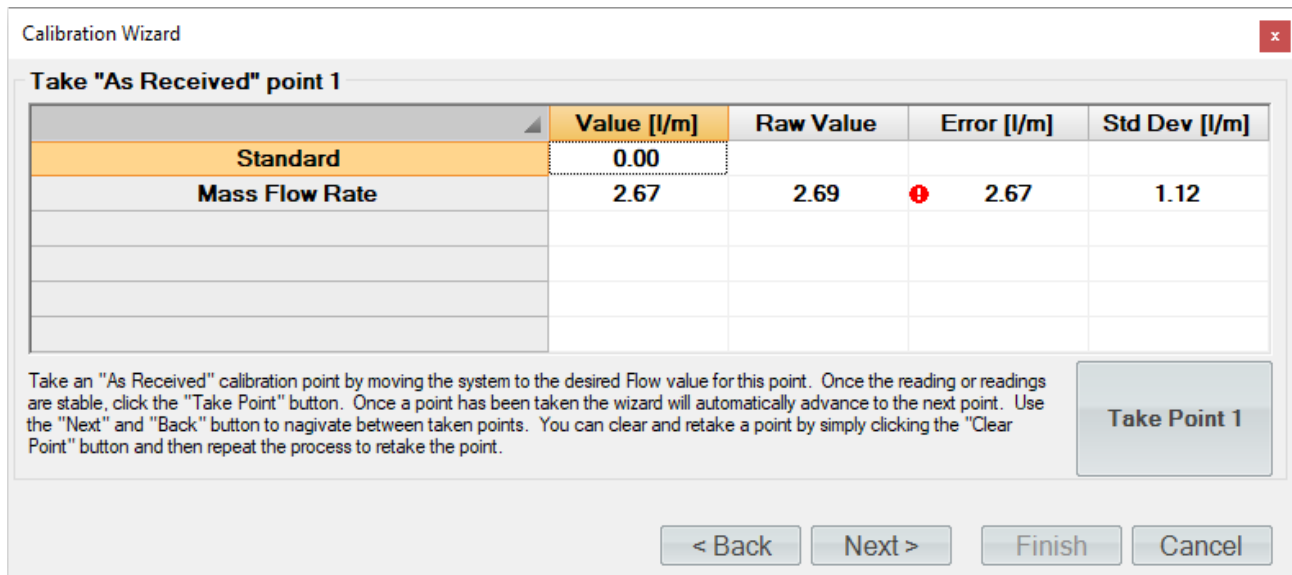

Enter the sample size used to perform the standard deviation calculation. The sample size is the given time that ControLog will use to determine which data points to use to determine the standard deviation of each probe.

Note - *The number of points used will be based on the data storage rate you have selected along with the desired sample size. For example, if the data storage rate is every 15 seconds then a sample size of 2.5 minute will result in 10 points being used to calculate the standard deviation.*

The screenshot shows a window titled "Calibration Wizard" with a close button in the top right corner. The main content area is titled "Enter sample size" and contains a text input field with the value "2.5" and a dropdown menu set to "minutes". Below the input field is a paragraph of explanatory text: "Enter the desired sample size for standard deviation calculation. Standard deviation is a statistic used to measure the variation in the actual data and can be thought of as how spread out or stable the data is. ControLog calculates the Standard Deviation from the device data tab for the points within the given sample size. Note: The sample size should always be carefully considered based on the data storage interval. Too small of a sample size in relation to the data storage interval will result in a small number of points used to calculate the Standard Deviation." At the bottom of the dialog are four buttons: "< Back", "Next >" (highlighted in yellow), "Finish", and "Cancel".

Select the number of points you would like to take for this "As Received" calibration. Each point defines what the "true" value is at a given point based on the standard or reference value. The number of points determines the degree of the polynomial used to align or correct the generator with the standard or reference.

The screenshot shows a window titled "Calibration Wizard" with a close button in the top right corner. The main content area is titled "Select the number of 'As Received' calibration points" and contains a list box with four options: "2 Points (linear)", "3 Points (quadratic)", "4 Points (cubic)", and "5 Points (quartic)". The "5 Points (quartic)" option is selected and highlighted in blue. Below the list box is a paragraph of explanatory text: "Select the number of points you would like to take for this 'As Received' calibration. Each point defines what the 'true' value is at a given point based on the standard or reference value. The number of points determines the degree of the polynomial used to align or correct the 2900 with the standard or reference. Lagrangian Interpolation is used to determine the coefficients of the polynomial." At the bottom of the dialog are four buttons: "< Back", "Next >" (highlighted in yellow), "Finish", and "Cancel".

With the generator shutdown, take a zero flow point. If the standard is not a connected device, then ControLog will ask for the value before taking the point. You can also enter a standard or reference value before taking a point by clicking the cell in the “Standard” row and “Value” column. This is useful for seeing error values before a point is taken.

Enter Value

Enter the current value of the standard or reference in l/m.

0.0

Ok Cancel

Once the reading is stable, click the “Take Point” button. Once a point has been taken, the wizard will automatically advance to the next point.

Calibration Wizard

Take "As Received" point 1

	Value [l/m]	Raw Value	Error [l/m]	Std Dev [l/m]
Standard	0.00			
Mass Flow Rate	0.13	0.07	0.13	
Flow Setpoint				

Take an "As Received" calibration point by moving the system to the desired Flow value for this point. Once the reading or readings are stable, click the "Take Point" button. Once a point has been taken the wizard will automatically advance to the next point. Use the "Next" and "Back" button to navigate between taken points. You can clear and retake a point by simply clicking the "Clear Point" button and then repeat the process to retake the point.

Take Point 1

< Back Next > Finish Cancel

Calibration Wizard

Take "As Received" point 1

	Value [l/m]	Raw Value	Error [l/m]	Std Dev [l/m]
Standard	0.00			
Mass Flow Rate	0.13	0.07	0.13	0.00
Flow Setpoint				

Take an "As Received" calibration point by moving the system to the desired Flow value for this point. Once the reading or readings are stable, click the "Take Point" button. Once a point has been taken the wizard will automatically advance to the next point. Use the "Next" and "Back" button to navigate between taken points. You can clear and retake a point by simply clicking the "Clear Point" button and then repeat the process to retake the point.

Take Point 1

< Back Next > Finish Cancel

Tip - Use the "Next" and "Back" button to navigate between taken points. You can clear and retake a point by simply clicking the "Clear Point" button and then repeat the process to retake the point.

Calibration Wizard

"As Received" Calibration point 1

	Value [l/m]	Raw Value	Error [l/m]	Std Dev [l/m]
Standard	0.00			
Mass Flow Rate	0.13	0.07	0.13	0.00
Flow Setpoint				

Take an "As Received" calibration point by moving the system to the desired Flow value for this point. Once the reading or readings are stable, click the "Take Point" button. Once a point has been taken the wizard will automatically advance to the next point. Use the "Next" and "Back" button to navigate between taken points. You can clear and retake a point by simply clicking the "Clear Point" button and then repeat the process to retake the point.

Clear Point 1

< Back Next > Finish Cancel

Enter the next flow rate (12.5 l/m) in the Flow Setpoint “Value” cell. This will start the 2900 generating a 0 °C dew at the current temperature setpoint. Wait for the system to become stable at the 0 °C dew point.

Enter Value

Enter the Flow Setpoint in l/m.

12.5

Ok Cancel

Using the flow standard, measure the next point. Once the readings are stable enter the standards value and click the “Take Point” button.

Calibration Wizard

Take "As Received" point 2

	Value [l/m]	Raw Value	Error [l/m]	Std Dev [l/m]
Standard	12.50			
Mass Flow Rate	12.53	12.60	0.03	5.11
Flow Setpoint	12.50			

Take an "As Received" calibration point by moving the system to the desired Flow value for this point. Once the reading or readings are stable, click the "Take Point" button. Once a point has been taken the wizard will automatically advance to the next point. Use the "Next" and "Back" button to navigate between taken points. You can clear and retake a point by simply clicking the "Clear Point" button and then repeat the process to retake the point.

Take Point 2

< Back Next > Finish Cancel

Continue generating a 0 °C dew point but advance the flow rate to the next point (25.0 l/m). Using the flow standard, measure the point and once the readings are stable enter the standards value and click the “Take Point” button.

Calibration Wizard

Take "As Received" point 3

	Value [l/m]	Raw Value	Error [l/m]	Std Dev [l/m]
Standard	25.00			
Mass Flow Rate	25.04	25.06	0.04	0.00
Flow Setpoint	25.00			

Take an "As Received" calibration point by moving the system to the desired Flow value for this point. Once the reading or readings are stable, click the "Take Point" button. Once a point has been taken the wizard will automatically advance to the next point. Use the "Next" and "Back" button to navigate between taken points. You can clear and retake a point by simply clicking the "Clear Point" button and then repeat the process to retake the point.

Take Point 3

< Back Next > Finish Cancel

Continue generating a 0 °C dew point but advance the flow rate to the next point (37.5 l/m). Using the flow standard, measure the point and once the readings are stable enter the standards value and click the “Take Point” button.

Calibration Wizard

Take "As Received" point 4

	Value [l/m]	Raw Value	Error [l/m]	Std Dev [l/m]
Standard	37.50			
Mass Flow Rate	37.49	37.47	-0.01	0.00
Flow Setpoint	37.50			

Take an "As Received" calibration point by moving the system to the desired Flow value for this point. Once the reading or readings are stable, click the "Take Point" button. Once a point has been taken the wizard will automatically advance to the next point. Use the "Next" and "Back" button to navigate between taken points. You can clear and retake a point by simply clicking the "Clear Point" button and then repeat the process to retake the point.

Take Point 4

< Back Next > Finish Cancel

Continue generating a 0 °C dew point but advance the flow rate to the last point (50.0 l/m). Using the flow standard, measure the point and once the readings are stable enter the standards value and click the “Take Point” button.

Take "As Received" point 5

	Value [l/m]	Raw Value	Error [l/m]	Std Dev [l/m]
Standard	50.00			
Mass Flow Rate	50.01	50.04	0.01	0.04
Flow Setpoint	50.00			

Take an "As Received" calibration point by moving the system to the desired Flow value for this point. Once the reading or readings are stable, click the "Take Point" button. Once a point has been taken the wizard will automatically advance to the next point. Use the "Next" and "Back" button to navigate between taken points. You can clear and retake a point by simply clicking the "Clear Point" button and then repeat the process to retake the point.

Take Point 5

< Back Next > Finish Cancel

When all flow points have been entered, ControLog will advance to the “As Received” calibration report. The flow meter will appear in its own tab and contains the data for each calibration point along with the coefficients used at the time the points were taken.

"As Received" calibration report

Calibration Report

TSC Model: 2900
TSC Serial Number: 0
Date and Time: 10/25/2017 2:21:58 PM

"As Received" Flow Calibration
UUT: Mass Flow Rate (000000)
Standard used: Flow Standard
Tolerance: ±2.5

Mass Flow Rate

The "As Received" calibration report for each item is displayed in the corresponding tabs for review. Each report contains the data for each calibration point and the coefficients applied at the time the point was taken. To save the reports click the "Save Reports" button.

Save Reports

< Back Next > Finish Cancel

Clicking the “Save Reports” button will open a file dialog to save the report. The default file location is ...Documents\Thunder Scientific\2900 ControLog\Reports\.

Clicking “Next” will ask the user if they want to calculate new coefficients using the as received data points just taken.

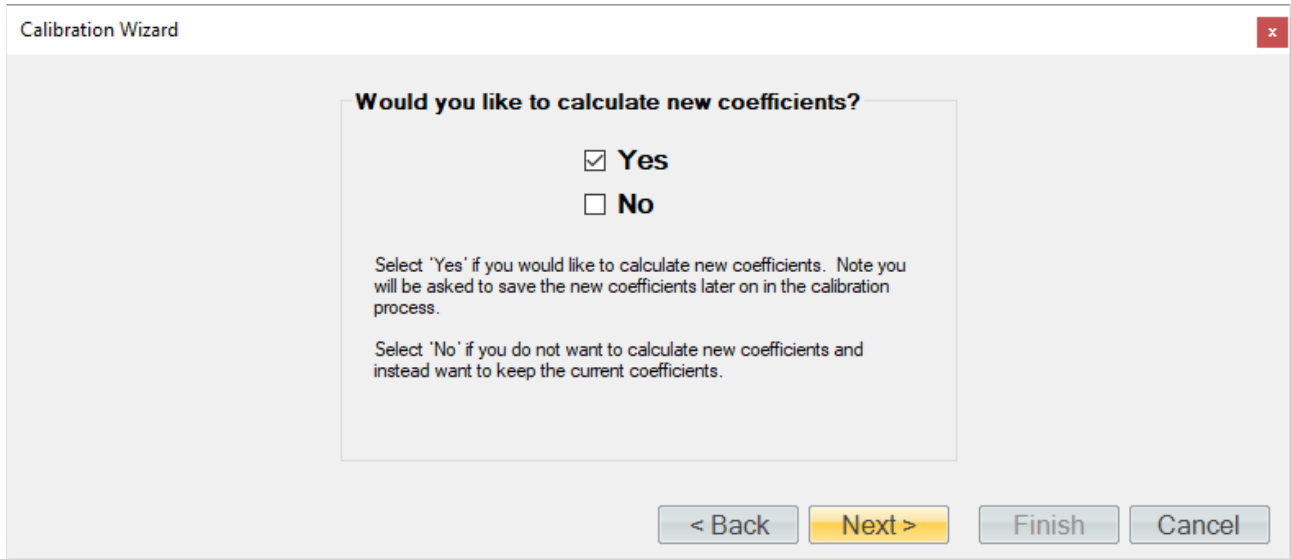

If the user selected to calculate new coefficients, they will be calculated and displayed. If any problem calculating the coefficient occurs, ControLog will issue a message telling the user that the coefficients could not be calculated.

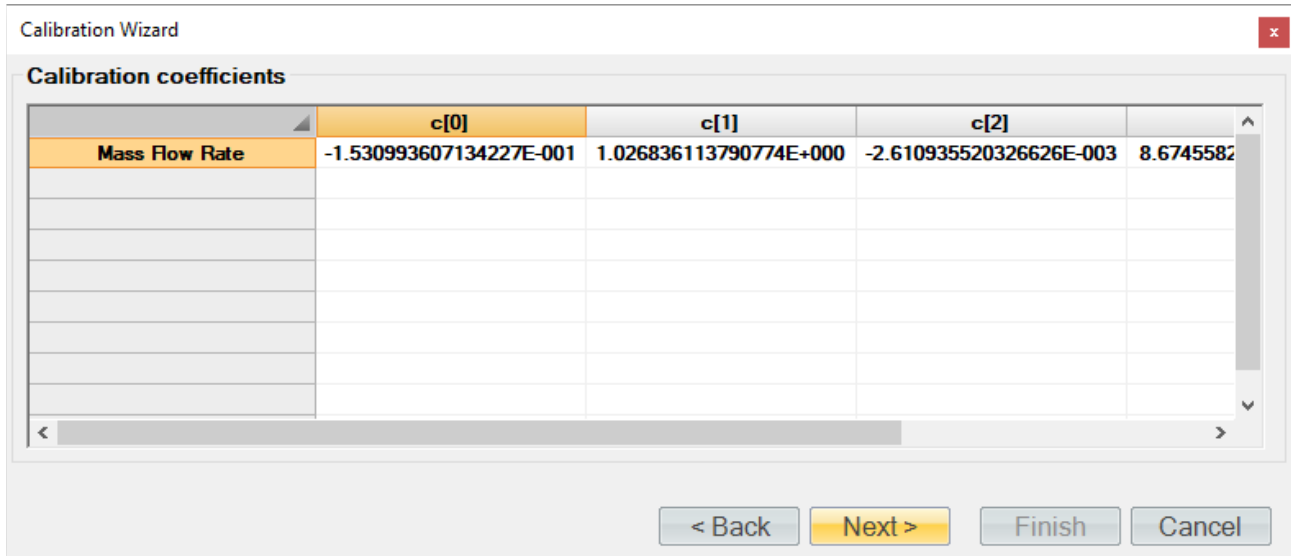

Next, the user will be asked to save the new coefficients to the system. Selecting “Yes” will result in the current coefficient being over-written by the newly calculated coefficients.

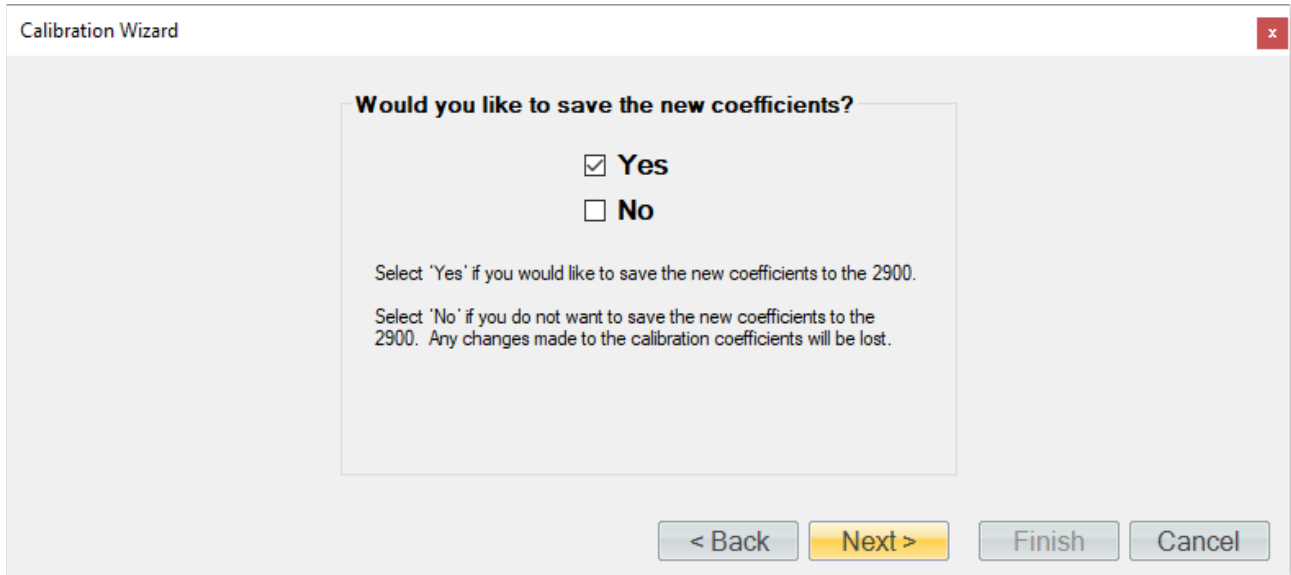

Next, the user can view and save the calibration coefficients report for the flow meter.

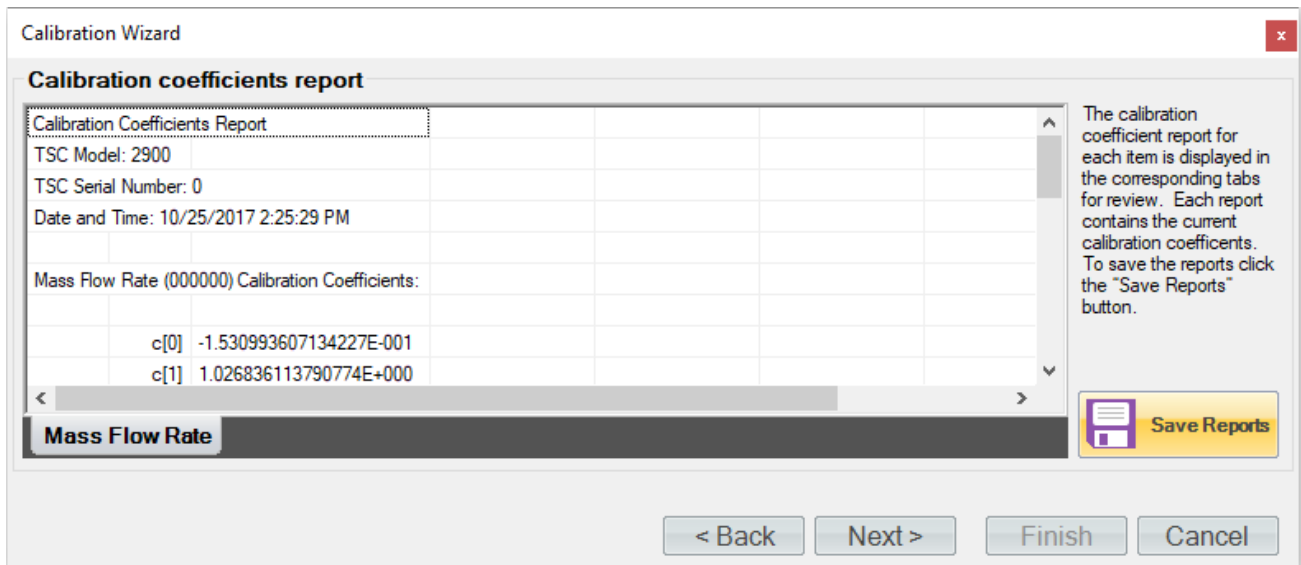

Next, the user can complete the calibration or choose to take “As Left” points.

The screenshot shows a window titled "Calibration Wizard" with a close button in the top right corner. The main content area contains a question: "Would you like to take 'As Left' points now?". Below the question are two radio button options: "Yes" (which is selected) and "No". Underneath the options, there are two lines of explanatory text: "Select 'Yes' if you would like to take 'As Left' points now." and "Select 'No' if you would like to finish the calibration now.". At the bottom of the dialog, there are four buttons: "< Back", "Next >" (highlighted in yellow), "Finish", and "Cancel".

ControLog allows the user to take as many “As Left” points as they would like. In this example we will check five points. If the standard is not a connected device, then ControLog will ask for the value before taking the point. You can also enter a standard or reference value before taking a point by clicking the cell in the “Standard” row and “Value” column. This is useful for seeing error values before a point is taken.

The screenshot shows a dialog box titled "Enter Value". The main text inside reads: "Enter the current value of the standard or reference in l/m.". Below this text is a text input field containing the number "50". At the bottom right of the dialog, there are two buttons: "Ok" (highlighted in yellow) and "Cancel".

Enter the first flow rate (50.0 l/m) in the Flow Setpoint “Value” cell to continue generating a 0 °C dew point.

The screenshot shows a dialog box titled "Enter Value". The main text inside reads: "Enter the Flow Setpoint in l/m.". Below this text is a text input field containing the number "50". At the bottom right of the dialog, there are two buttons: "Ok" (highlighted in yellow) and "Cancel".

Using the flow standard, measure the point and once the readings are stable enter the standards value and click the "Take Point" button.

Calibration Wizard

Take "As Left" point 1

	Value [l/m]	Raw Value	Error [l/m]	Std Dev [l/m]
Standard	50.00			
Mass Flow Rate	49.90	49.91	-0.10	0.05
Flow Setpoint	50.00			

Take an "As Left" calibration point by moving the system to the desired Flow value for this point. Once the reading or readings are stable, click the "Take Point" button. Once a point has been taken the wizard will automatically advance to the next point. Use the "Next" and "Back" button to navigate between taken points. You can clear and retake a point by simply clicking the "Clear Point" button and then repeat the process to retake the point.

Take Point 1

< Back Next > Finish Cancel

Tip - Use the "Next" and "Back" button to navigate between taken points. You can clear and retake a point by simply clicking the "Clear Point" button and then repeat the process to retake the point.

Calibration Wizard

"As Left" Calibration point 1

	Value [l/m]	Raw Value	Error [l/m]	Std Dev [l/m]
Standard	50.00			
Mass Flow Rate	49.90	49.91	-0.10	0.05
Flow Setpoint	50.00			

Take an "As Left" calibration point by moving the system to the desired Flow value for this point. Once the reading or readings are stable, click the "Take Point" button. Once a point has been taken the wizard will automatically advance to the next point. Use the "Next" and "Back" button to navigate between taken points. You can clear and retake a point by simply clicking the "Clear Point" button and then repeat the process to retake the point.

Clear Point 1

< Back Next > Finish Cancel

Continue generating a 0 °C dew point but advance the flow rate to the next point (40.0 l/m). Using the flow standard, measure the point and once the readings are stable enter the standards value and click the “Take Point” button.

Calibration Wizard

Take "As Left" point 2

	Value [l/m]	Raw Value	Error [l/m]	Std Dev [l/m]
Standard	40.00			
Mass Flow Rate	39.98	39.84	-0.02	0.00
Flow Setpoint	40.00			

Take an "As Left" calibration point by moving the system to the desired Flow value for this point. Once the reading or readings are stable, click the "Take Point" button. Once a point has been taken the wizard will automatically advance to the next point. Use the "Next" and "Back" button to navigate between taken points. You can clear and retake a point by simply clicking the "Clear Point" button and then repeat the process to retake the point.

Take Point 2

< Back Next > Finish Cancel

Continue generating a 0 °C dew point but advance the flow rate to the next point (30.0 l/m). Using the flow standard, measure the point and once the readings are stable enter the standards value and click the “Take Point” button.

Calibration Wizard

Take "As Left" point 3

	Value [l/m]	Raw Value	Error [l/m]	Std Dev [l/m]
Standard	30.00			
Mass Flow Rate	30.01	30.04	0.01	0.00
Flow Setpoint	30.00			

Take an "As Left" calibration point by moving the system to the desired Flow value for this point. Once the reading or readings are stable, click the "Take Point" button. Once a point has been taken the wizard will automatically advance to the next point. Use the "Next" and "Back" button to navigate between taken points. You can clear and retake a point by simply clicking the "Clear Point" button and then repeat the process to retake the point.

Take Point 3

< Back Next > Finish Cancel

Continue generating a 0 °C dew point but advance the flow rate to the next point (20.0 l/m). Using the flow standard, measure the point and once the readings are stable enter the standards value and click the “Take Point” button.

Calibration Wizard

Take "As Left" point 4

	Value [l/m]	Raw Value	Error [l/m]	Std Dev [l/m]
Standard	20.00			
Mass Flow Rate	20.04	20.12	0.04	0.00
Flow Setpoint	20.00			

Take an "As Left" calibration point by moving the system to the desired Flow value for this point. Once the reading or readings are stable, click the "Take Point" button. Once a point has been taken the wizard will automatically advance to the next point. Use the "Next" and "Back" button to navigate between taken points. You can clear and retake a point by simply clicking the "Clear Point" button and then repeat the process to retake the point.

Take Point 4

< Back Next > Finish Cancel

Continue generating a 0 °C but advance the flow rate to the next point (10.0 l/m). Using the flow standard, measure the point and once the readings are stable enter the standards value and click the “Take Point” button.

Calibration Wizard

Take "As Left" point 5

	Value [l/m]	Raw Value	Error [l/m]	Std Dev [l/m]
Standard	10.00			
Mass Flow Rate	10.18	10.22	0.18	0.00
Flow Setpoint	10.00			

Take an "As Left" calibration point by moving the system to the desired Flow value for this point. Once the reading or readings are stable, click the "Take Point" button. Once a point has been taken the wizard will automatically advance to the next point. Use the "Next" and "Back" button to navigate between taken points. You can clear and retake a point by simply clicking the "Clear Point" button and then repeat the process to retake the point.

Take Point 5

< Back Next > Finish Cancel

When you have taken the desired amount of “As Left” temperature points, click the “Next” button to view the “As Received” calibration report. The flow meter will appear in its own tab and contains the data for each calibration point along with the coefficients used at the time the points were taken.

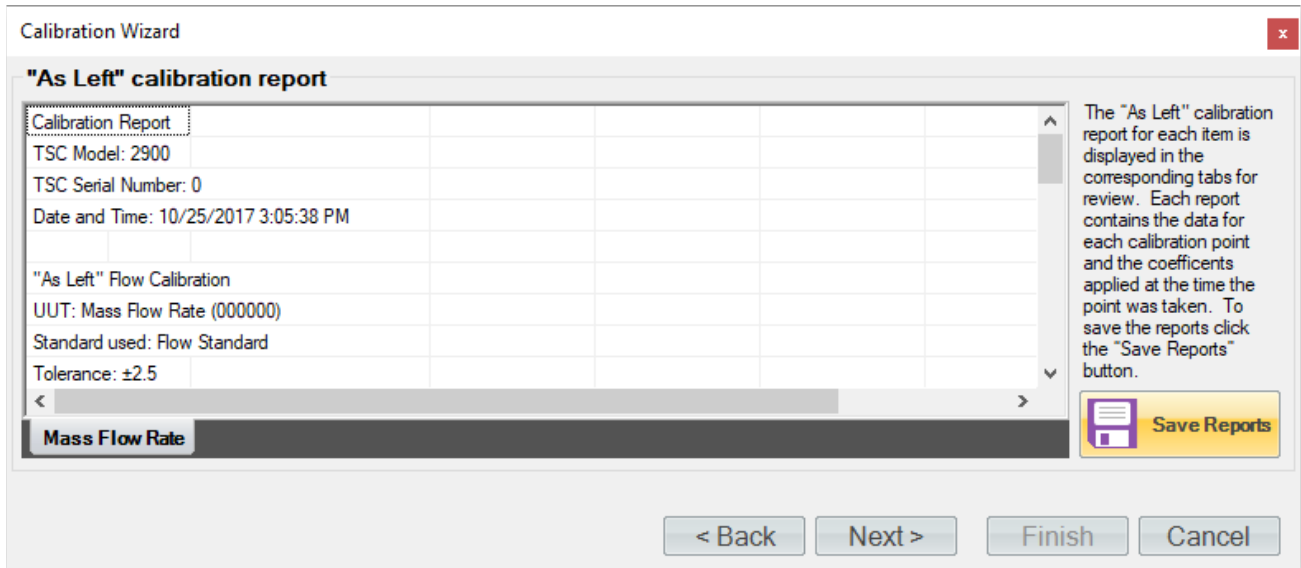

Clicking the “Save Reports” button will open a file dialog to save the report. The default file location is ...Documents\Thunder Scientific\2900 ControLog\Reports\.

6.4 VIEWING AND EDITING CALIBRATION COEFFICIENTS

The calibration coefficients for any calibration item can be viewed and or edited using the Calibration Wizard. ControLog uses the follow equation to apply calibration coefficients:

$$f(x) = c_4x^4 + c_3x^3 + c_2x^2 + c_1x + c_0$$

Where x is the raw value, c_0 , c_1 , c_2 , c_3 and c_4 are the coefficients and $f(x)$ is the calibrated value for the given coefficients and raw value.

Note – Editing calibration coefficients requires Manager Access Level or above.

Select Generator Calibration from the Utilities menu tab to open the Calibration Wizard.

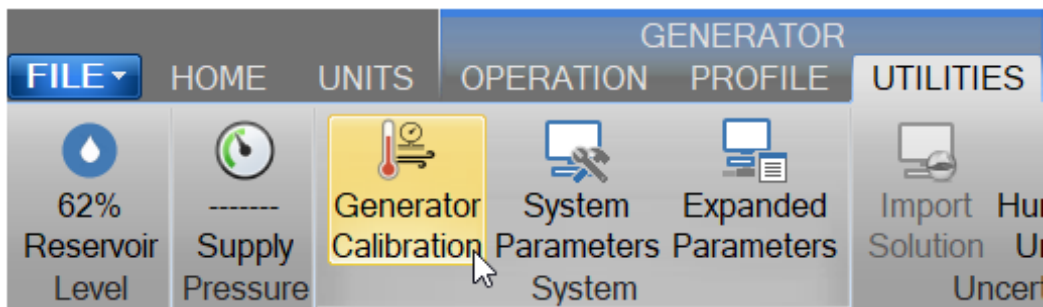

Select View or edit coefficients.

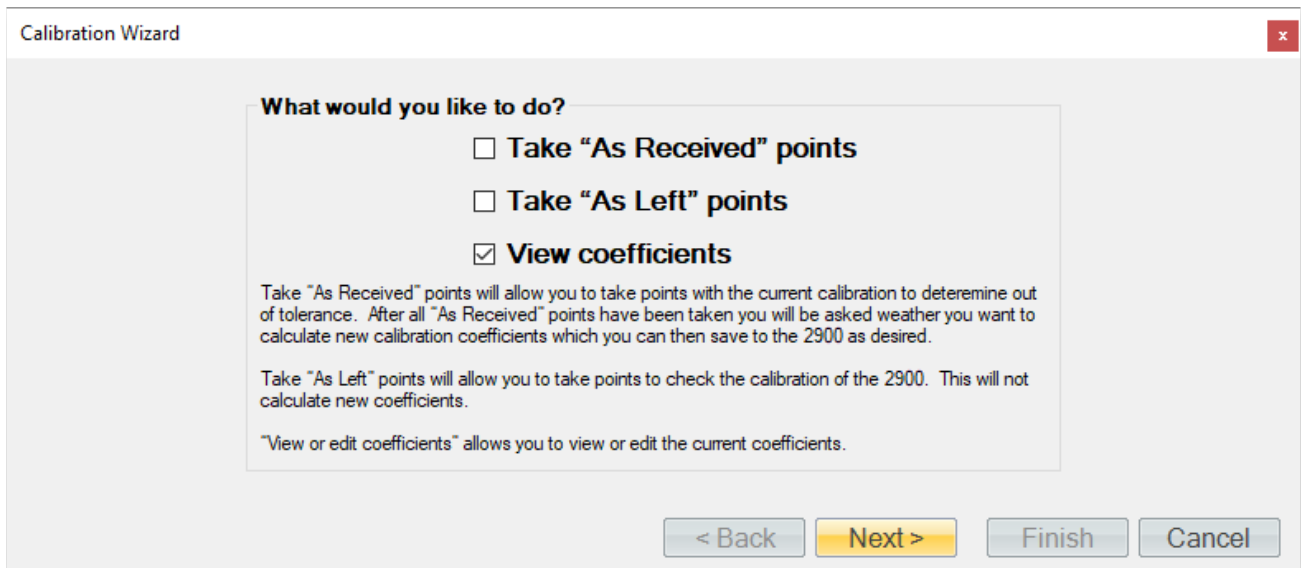

Select the type of calibration and the items you wish to view or edit coefficients for.

Calibration Wizard

Select the type and items to calibrate

Select the type of calibration you would like to perform on the 2900. Once a type has been selected you can select the items of the type that you would like to calibrate. If multiple items are selected then they must be compared to the same reference or standard point. If different points are needed from one item to another item then only select one and repeat the wizard to complete the other desired items.

Type of Calibration:

- Flow
- Pressure
- Temperature

Items to Calibrate:

< Back Next > Finish Cancel

The calibration coefficients are then shown for the selected items.

Calibration Wizard

Calibration coefficients

	c[0]	c[1]	c[2]	
Saturation Pressure	-1.406690690750680E-003	1.000171389729250E+000	-4.894113820602890E-006	4.7830004

< Back Next > Finish Cancel

To edit the coefficients, simply click in the cell of the coefficient you wish to edit and enter a new value using the keyboard.

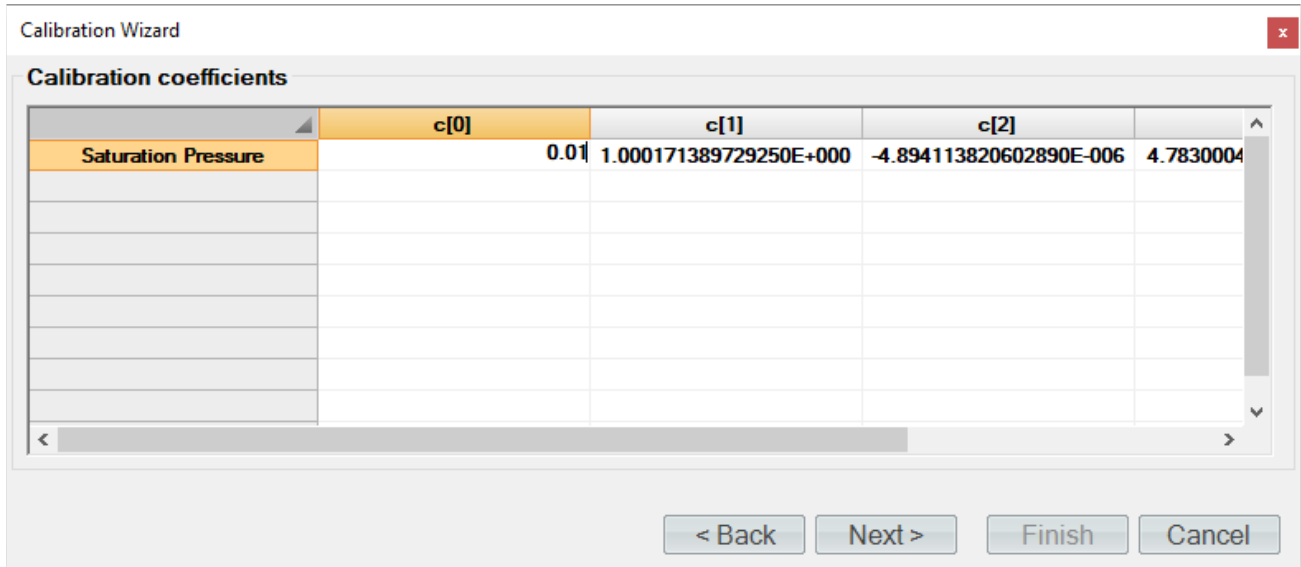

Next, the user will be asked to save the new coefficients to the system. Selecting "Yes" will result in the current coefficient being over-written by the newly calculated coefficients.

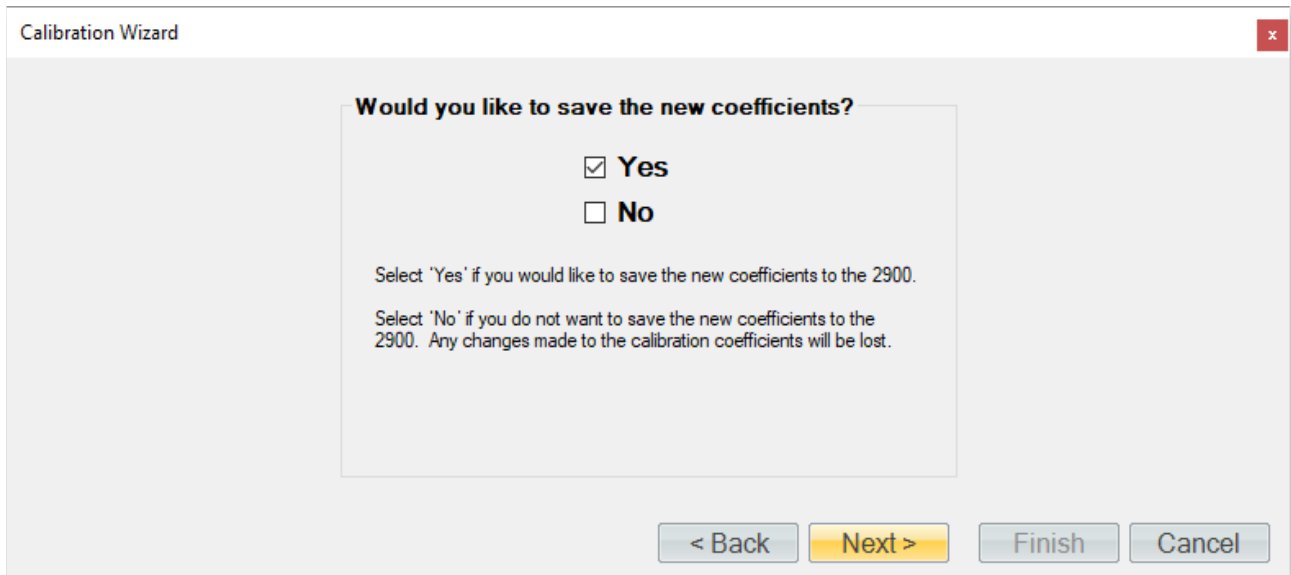

A new calibration coefficients report will be generated.

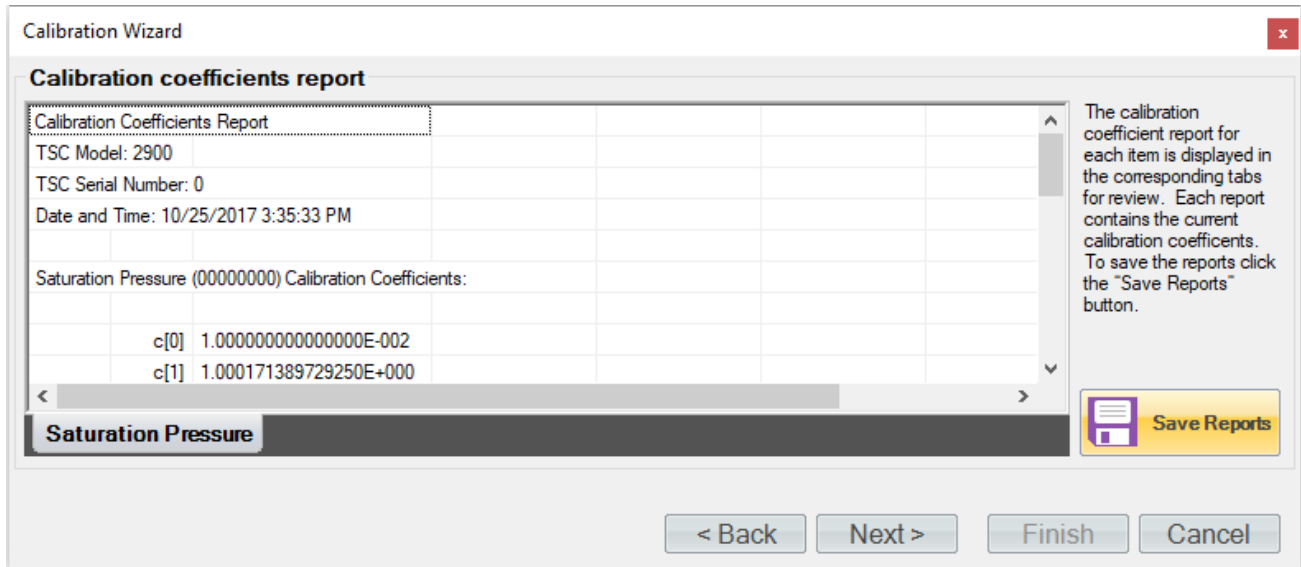

Clicking the “Save Reports” button will open a file dialog to save the report. The default file location is ...Documents\Thunder Scientific\2900 ControLog\Reports\. If the report is saved in an Excel format, then each probe or transducer will appear in its own tab within the workbook. The user wishes to save in a text-based format then a file for each probe calibrated will be created

7 GRAPHING

Graphing is a powerful tool used to view previously recorded data or to monitor the current data in real time. The graph works hand in hand with the data tabs. While the generator is in operation, data tabs store the most recent data points from the connected devices at the desired interval. A graph can be used to create a visual picture of this stored data.

Graph operations can be accessed by two means, either by selecting the desired command from the graph menu at the top or by long pressing or right clicking a graph tab and opening a context menu. The functionality of the commands is the same regardless of which method is used, but remember that the menu commands are dynamic and reflect operations that can be performed on the selected graph tab.

Note - *ControLog has a limit of fifteen graph tabs opened at any given time.*

Each graph tab consists of a two-dimension plot across an X and Y Axis. The graph can be customized to display different point symbols, various line colors, a legend and a header.

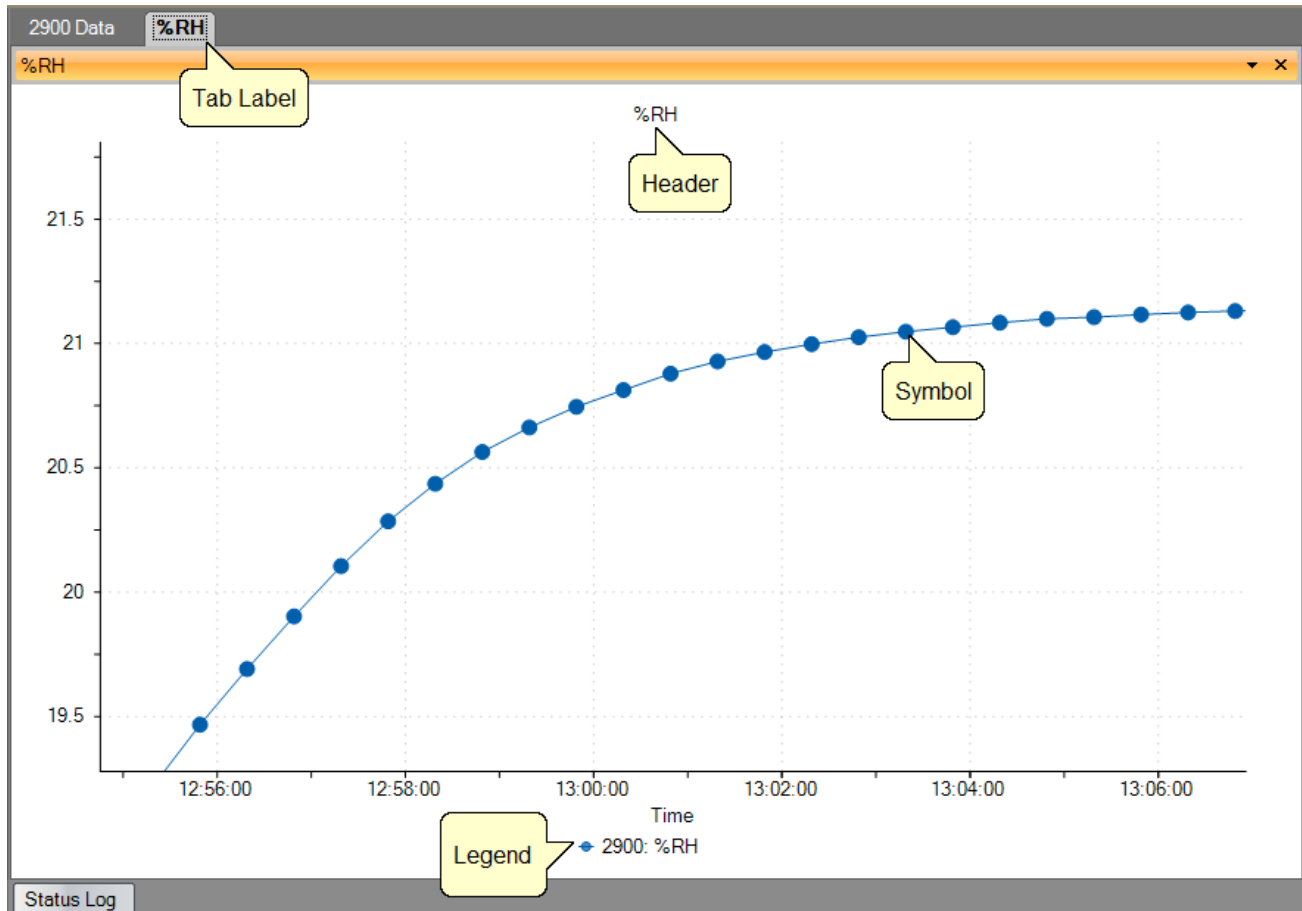

7.1 CREATING A NEW GRAPH

A new graph can be created using the New Graph Wizard dialog. The wizard will walk the user through the selection process of what data the user would like to include in the new graph and how it should look. To create a new graph, select “New” from the Home Menu Tab, Graph Menu Tab or right click any graph tab and select “New” from its context menu.

A “New Graph Wizard” dialog will appear.

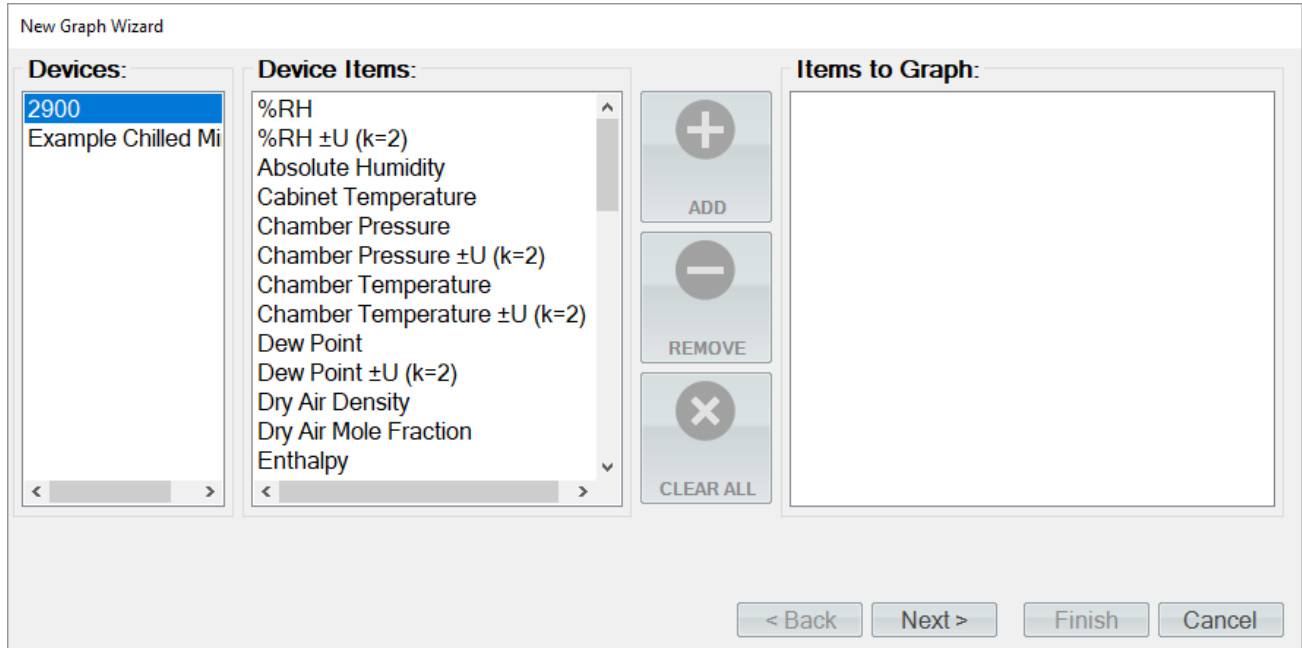

The first page of the New Graph Wizard is where the user selects which device items they would like to include in the graph. On the left-hand side is a list of all available devices. Selecting a device will result in the “Device Items” list being updated to reflect the available items for the selected device. To add an item, highlight the desired item or items in the “Device Items” list and click the “Add” button.

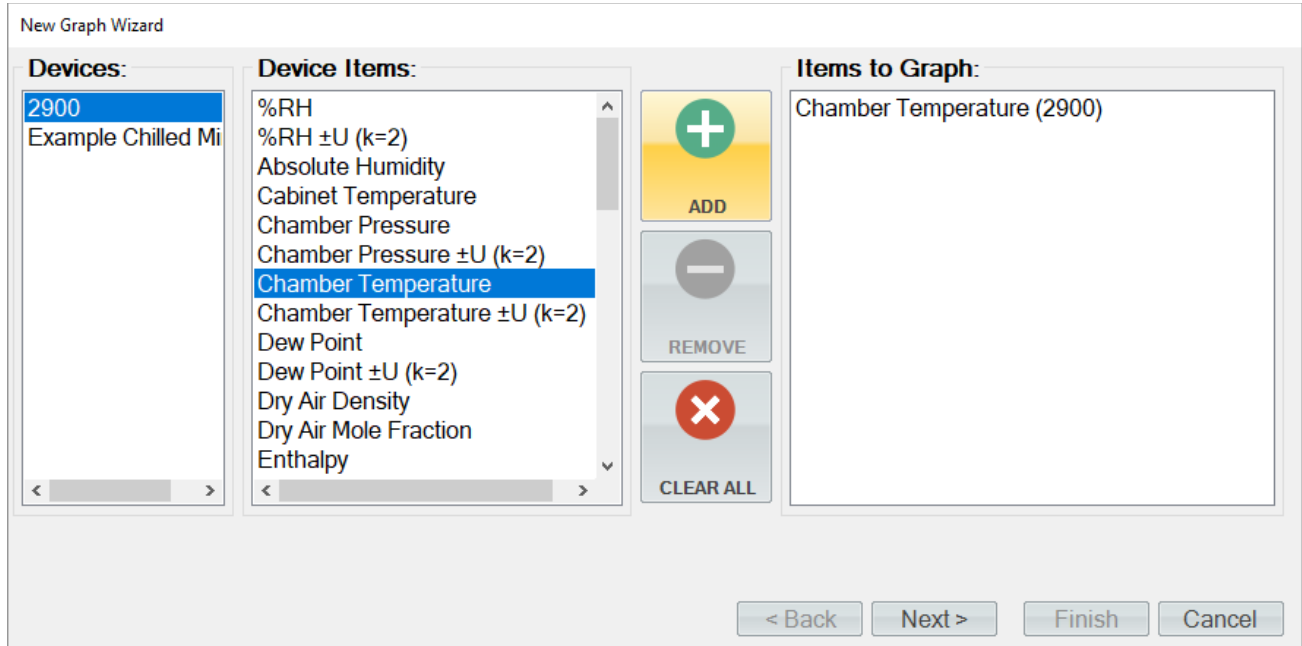

Repeat this process until all of the desired items are listed on the right side.

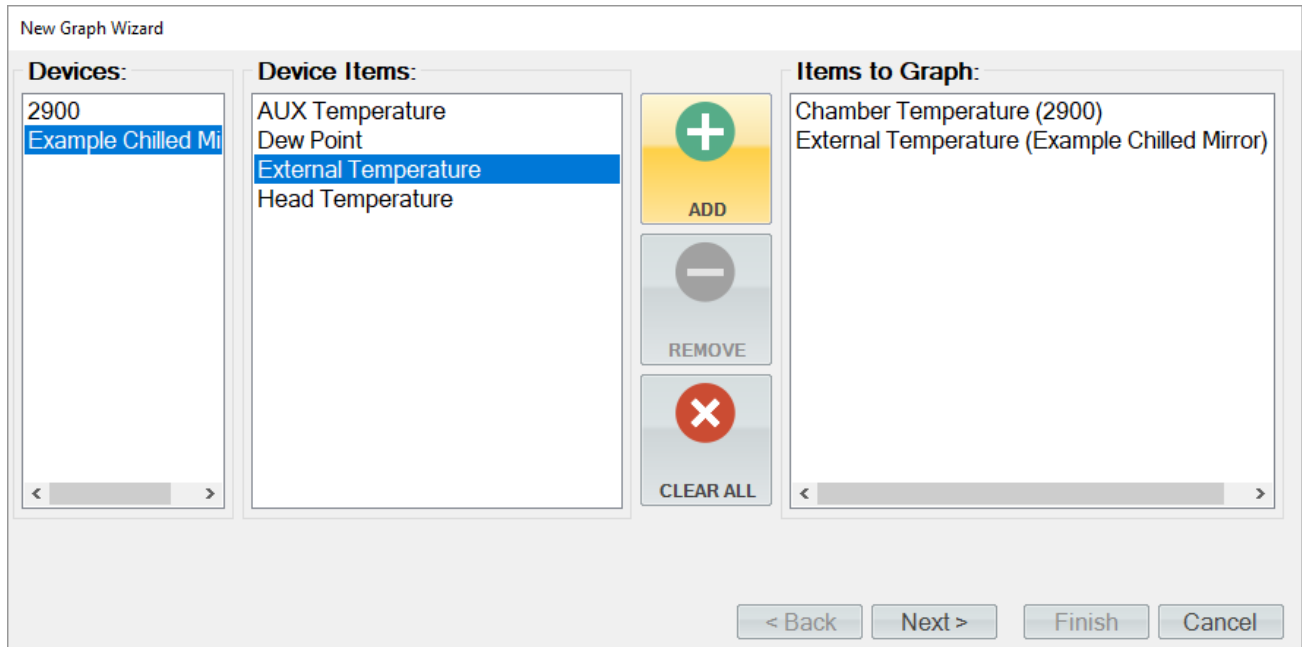

Note - The user can invert any selection by right clicking. This will highlight all items that are not currently highlighted and will remove highlight from any items that are currently highlighted.

To remove an item from the list of items to graph, the user can either click the “Clear All” button to remove all items or simply select the desired item from the “Items to Graph” list and click the “Remove” button.

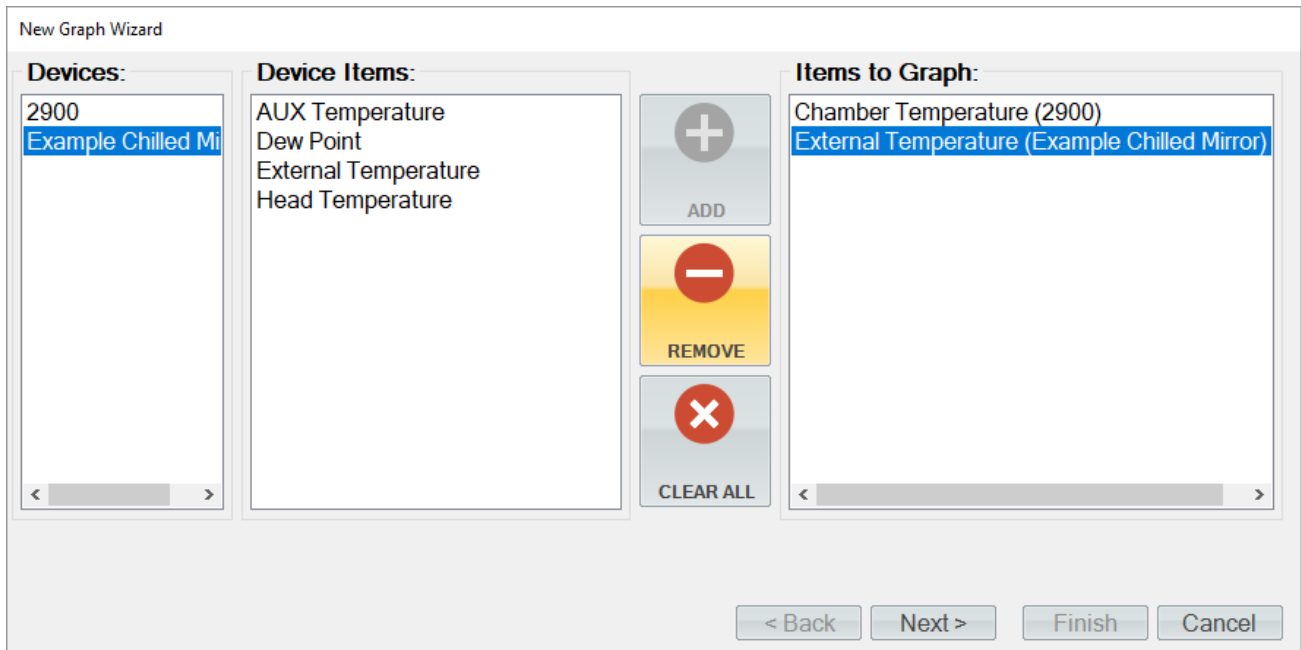

Once complete, clicking the “Next” button will bring up the Properties page. From the properties page the user can customize the look of each graphed line along with the chart itself.

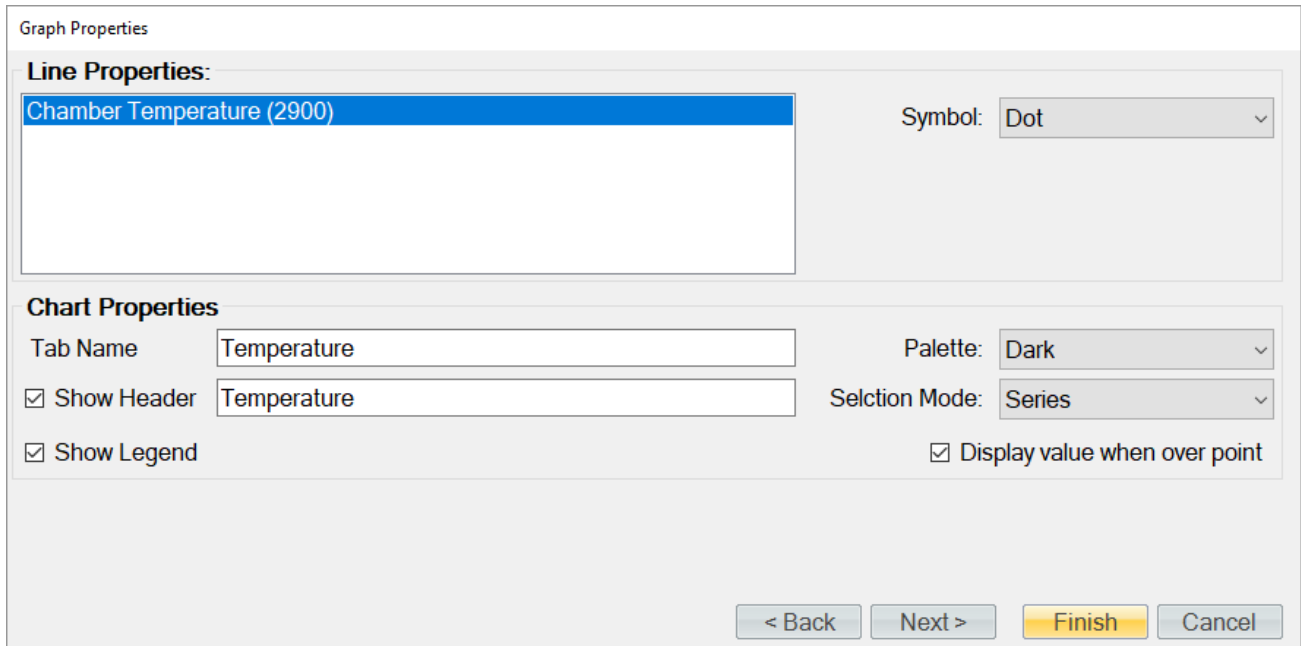

7.1.1 Line Properties

Line Properties define the color and point symbol for the selected line. Select the desired line from the selection box and set the Color, Symbol, whether to smooth the line, and whether to show data labels and how often to show them.

- Symbol defines the symbol drawn at each point. The symbol will be the same color as the line and will be shown at each data point. To change the symbol, select the desired symbol from the drop-down list.

7.1.2 Chart Properties

Chart Properties define the name of the graph tab, indicates whether to show a header on the graph and whether to show a legend of the lines plotted.

- Tab Name defines the name of the graph tab. This is the name the user will see appear in the Data and Graph Tab Group.
- Show Header defines the header that will appear at the top of the graph. To add a header to the graph, check the checkbox and enter the desired text description for the header.
- Show Legend defines whether a legend will be displayed on the right-hand side of the graph indicating which colored line is which data item.
- Palette defines the color palette that the lines will be drawn in. To change the palette, select the desired color palette from the drop-down list.
- Selection Mode allows the user to highlight different lines within the graph.

Once complete, clicking the “Finish” button will display the new graph in the Data and Graph Tab Group.

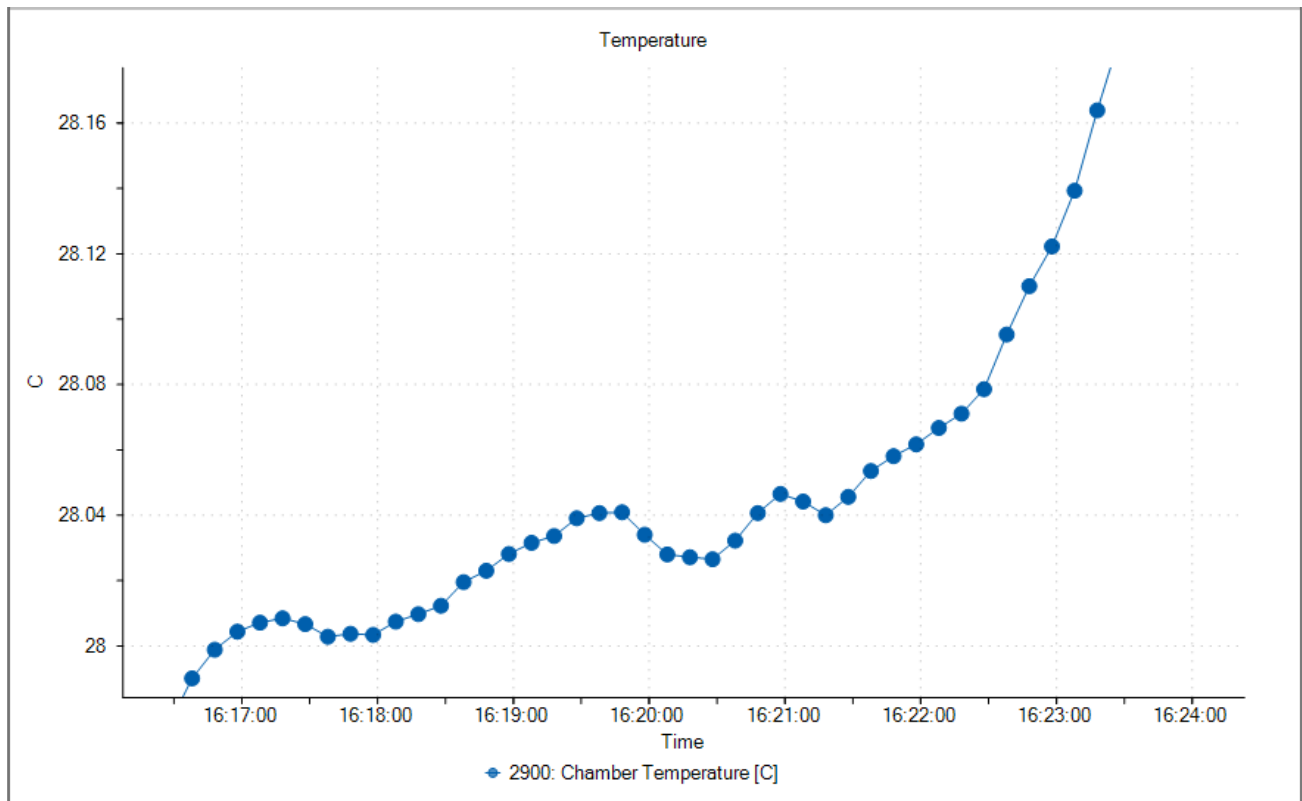

7.2 CUSTOMIZING A GRAPH

Each graph tab can be customized to display the data in different means. The user can Pan, Zoom and Scale the graph to the desired appearance.

7.2.1 Pan

The graph can be panned up and down as well as left and right by a left click and hold of the mouse button or by a touch gesture while the user moves the cursor around. Panning is useful when you have zoomed the graph and want to view different parts of the data without changing the scaling.

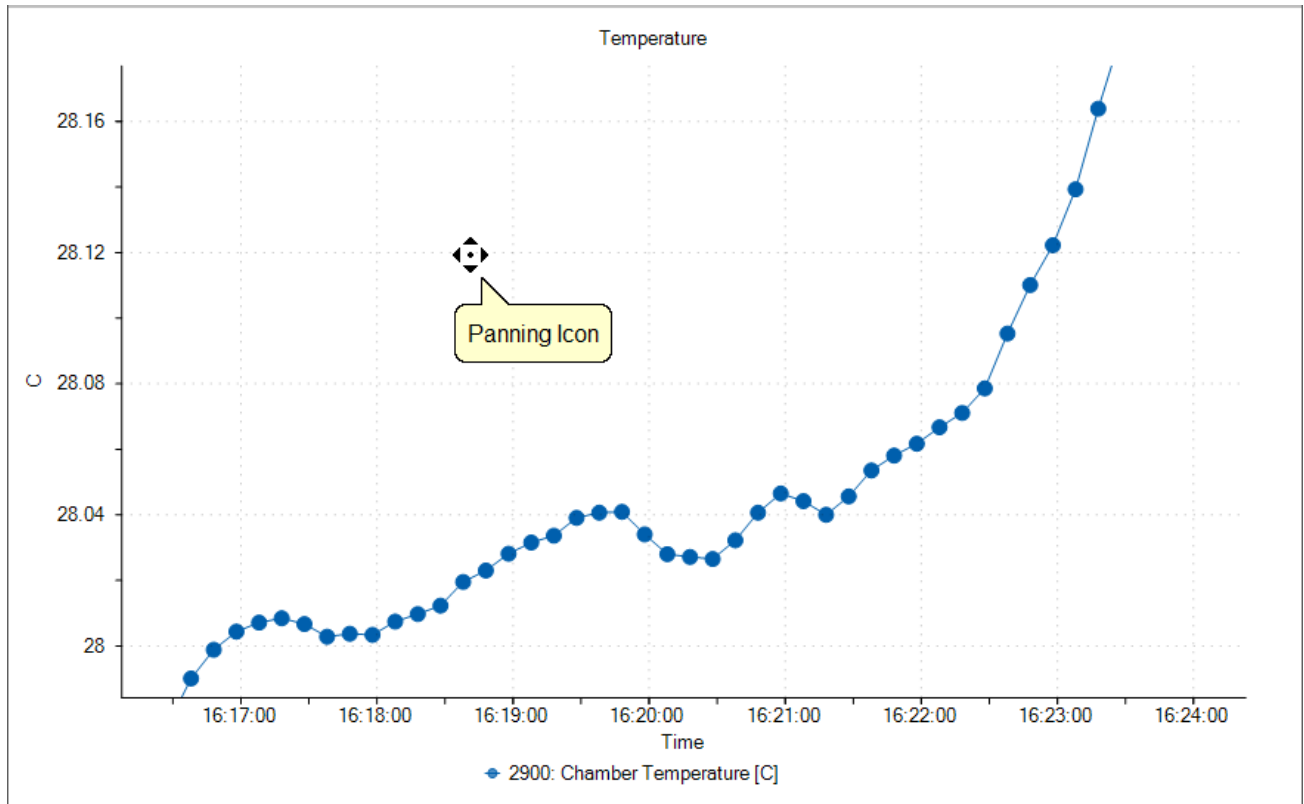

7.2.2 Zoom

The user can select to zoom the graph from the Graph Menu Tab or by using a “pinch” gesture. Using the cursor, left click and drag to create a box around the portion to zoom and release the left mouse button. The portion of the graph within the drag box will expand to fill the entire graph. The time and Y-axis limits update accordingly.

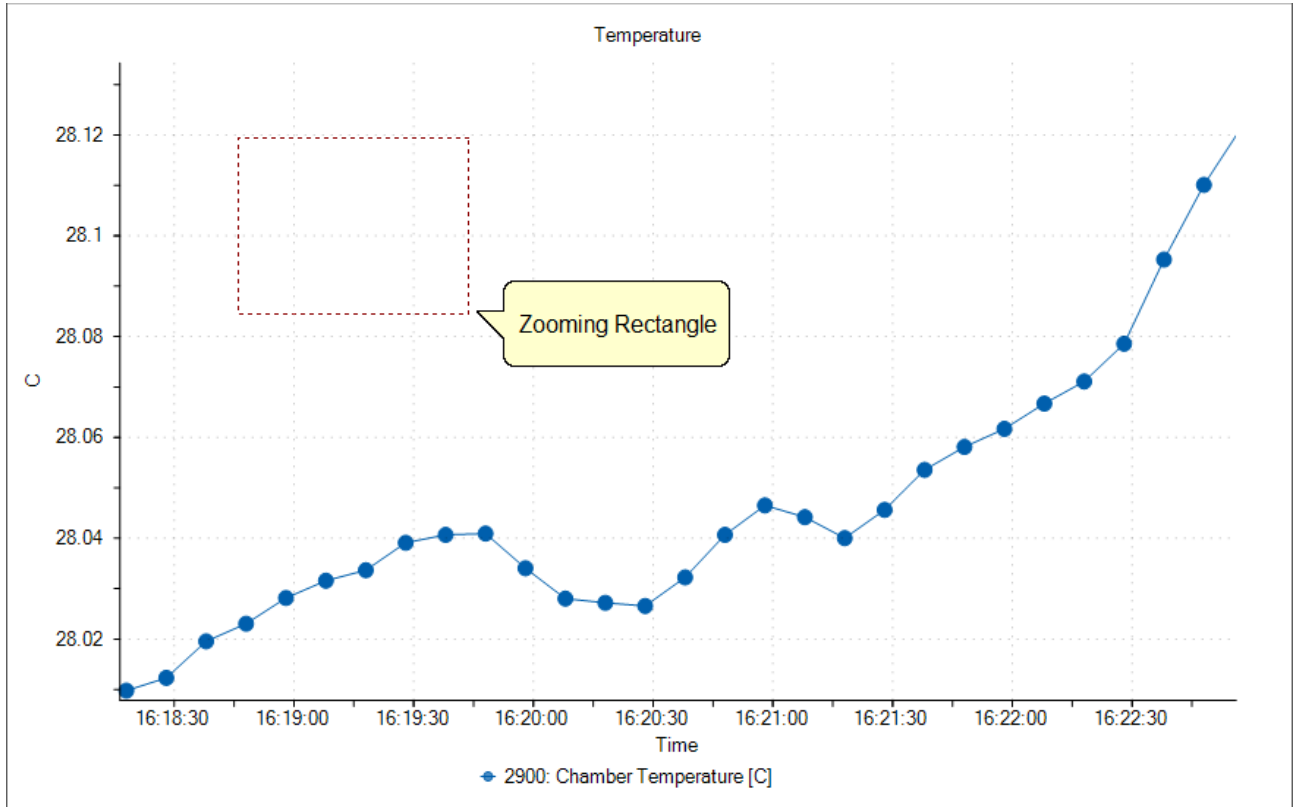

7.2.3 Zoom Graph's X Axis

The user can select to zoom the X axis of the graph from the Graph Menu Tab. Using the cursor, left click on the graph and drag the cursor so that the portion of the X-axis (time axis) of interest is contained within the two vertical dashed lines. The portion contained within this region will expand to fill the entire X-axis. The Y-axis remains unchanged.

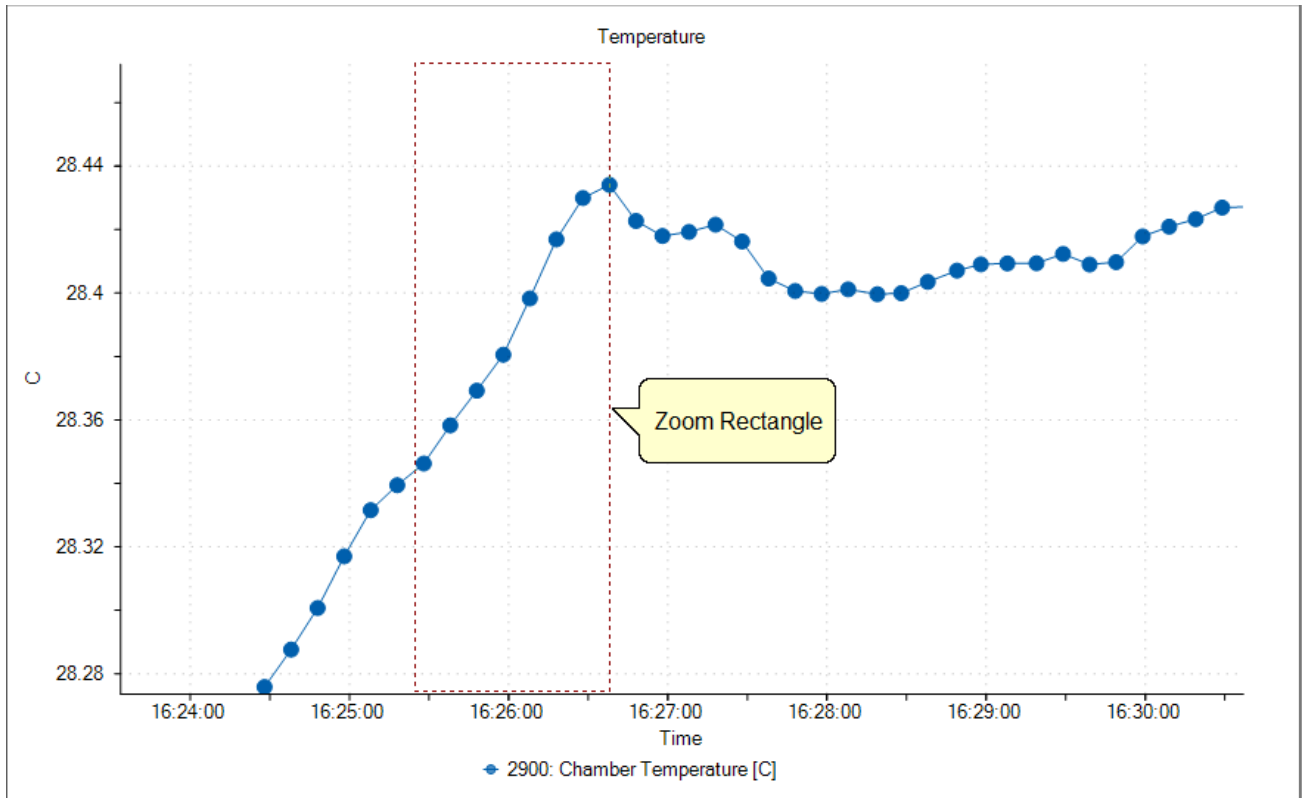

7.2.4 Zoom Graph's Y Axis

The user can select to zoom the Y axis of the graph from the Graph Menu Tab. Using the cursor, left click on the graph and drag the cursor so that the portion of the Y-axis of interest is contained within the two horizontal dashed lines. The portion contained within this region will expand to fill the entire Y-axis. The X-axis remains unchanged.

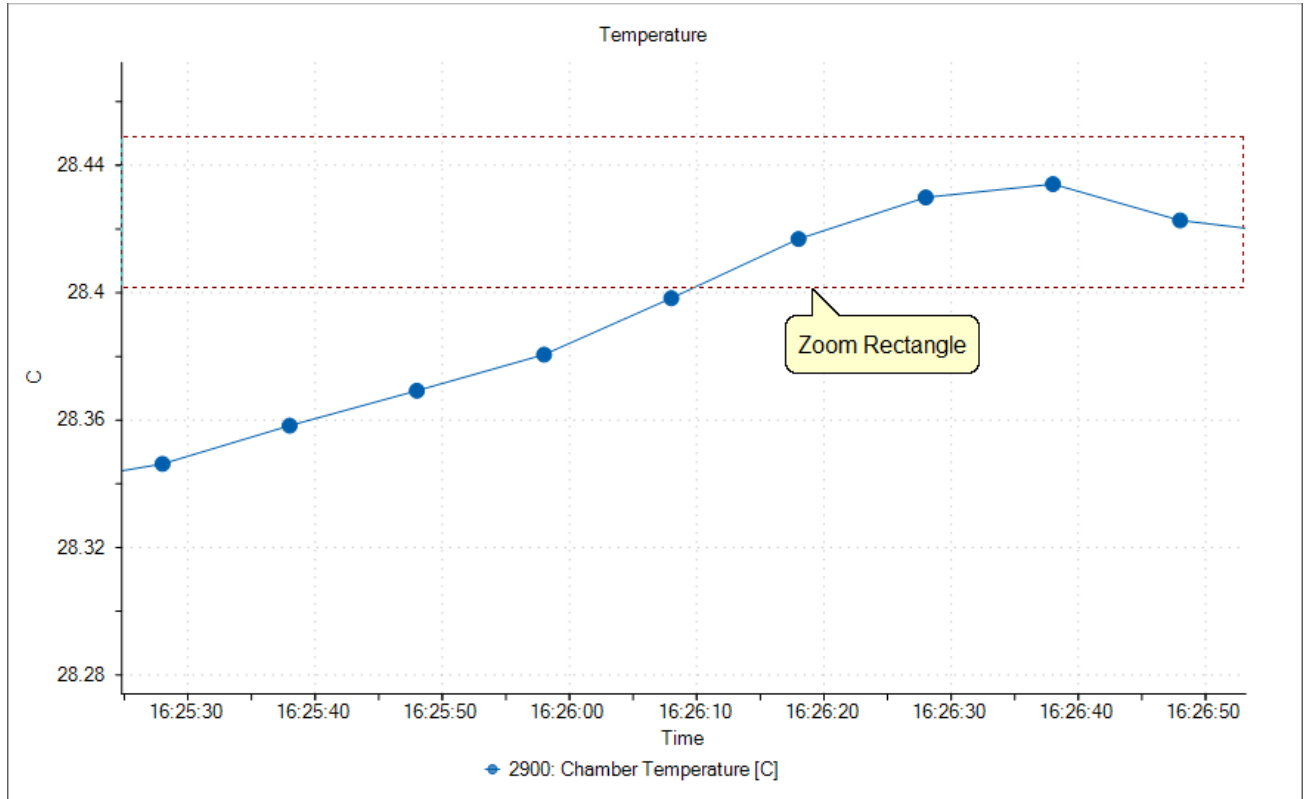

7.2.5 Auto Scale

Selecting the Auto Scale command will automatically reset both axis of the graph so the entire data set for each selected item is contained within the boundaries of the graph.

7.2.6 Scale

The Scale command allows the user to scale the X and Y axis. Dragging the cursor up scales the display in (zooms in) and dragging the cursor down scales the display out (zoom out).

7.2.7 Scale X Axis

The Scale X Axis command allows the user to scale the X axis. Dragging the cursor up scales the X Axis in (zooms Y Axis in) and dragging the cursor down scales the X Axis out (zooms X Axis out).

7.2.8 Scale Y Axis

The Scale Y Axis command allows the user to scale the Y axis. Dragging the cursor up scales the Y Axis in (zooms Y Axis in) and dragging the cursor down scales the Y Axis out (zooms Y Axis out).

7.2.9 Graph Properties

The Graph Properties command allows the user to modify the properties of the selected graph. Selecting the command opens the Graph Properties dialog that allows the user to make changes to what data is graphed, line properties and axis values.

Graph Properties

Line Properties:

Chamber Temperature (2900)

Symbol: Dot

Chart Properties

Tab Name: Temperature

Palette: Dark

Show Header: Temperature

Show Legend

Selction Mode: Series

Display value when over point

< Back Next > Finish Cancel

The first two pages of the Graph Properties dialog are the same as the New Graph Wizard that is used to create new graphs. The Graph Properties dialog starts on the properties page from which the user can customize the look of each graphed line as well as the chart itself. Clicking the “Back” button will move back to the data selection page where the user can select which device items they would like to include in the graph.

Clicking the “Next” button will move to the Axis page where the user can specify the starting and ending X and Y axis values.

The screenshot shows the 'Graph Properties' dialog box. It is divided into two main sections: 'Y Axis Limits' and 'X Axis Limits'.
Y Axis Limits: This section contains four input fields. The top field has the value '28.448912'. The second field has '28.394158' and a '±' symbol followed by '0.05475'. The third field has a checked 'Auto' checkbox and the value '28.339404'.
X Axis Limits: This section contains two date and time input fields. The first is '06/07/18 4:25:24 PM' and the second is '06/07/18 4:26:53 PM'. Below these are two checkboxes: 'Auto Min' (checked) and 'Auto Max' (checked).
Graph: A line graph is displayed in the center, showing a green curve with several data points marked by small squares. The graph is overlaid on a grid.
Buttons: At the bottom right of the dialog are four buttons: '< Back', 'Next >', 'Finish', and 'Cancel'.

7.2.9.1 Y Axis Limits

The Y Axis Limits define the maximum, minimum, middle and span values for the Y Axis.

- The Maximum value defines the maximum Y value for the Y Axis. No values beyond this maximum will be displayed on the graph.
- The Minimum value defines the minimum Y value for the Y Axis. No values below this minimum will be displayed on the graph.
- The Middle value defines the middle Y value for the Y Axis.
- The Span value defines the amount above and below the middle value where the maximum and minimum Y values lie.
- The Auto check box tells ControLog to automatically calculate the best Y Axis limits to encompass the current data.

Note - *The maximum, minimum, middle, and span values are interrelated and changing any one value may result in another value automatically changing to assure all values mathematically equate.*

7.2.9.2 X Axis Limits

The X Axis Limits define the maximum and minimum values for the X Axis.

- The Minimum value defines the minimum date and time for the X Axis. No values below this minimum date and time will be displayed on the graph.
- The Auto Min check box tells ControLog to automatically use the starting date and time for the current data as the X Axis minimum.
- The Maximum value defines the maximum date and time for the X Axis. No values above this maximum date and time will be displayed on the graph.
- The Auto Max check box tells ControLog to automatically use the last date and time for the current data as the X Axis maximum. The graph will constantly expand as new data points are recorded.

Once complete, clicking the “Finish” button will display the graph in the same tab with the new property settings.

7.3 SAVING A GRAPH

Each graph tab can be saved to a file in any of the following graphic file types:

- Bitmap (*.bmp)
- Graphics Interchange Format (*.gif)
- Joint Photographic Experts Group (*.jpg)
- W3C Portable Network Graphics (*.png)
- EMF Enhanced Metafile Format (*.emf)

To perform the save, select “Save” from the graph menu tab or right click a graph and select “Save”.

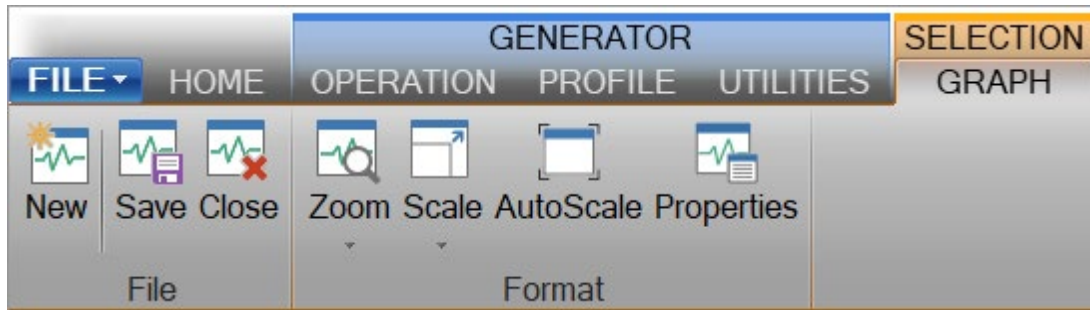

Or

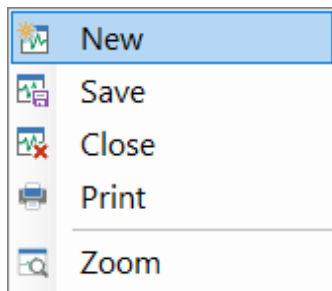

Using the “Save” dialog, select the location, name and graphic type you want to save the graph as.

Note - *ControlLog* defaults the file name to the name of the graph tab.

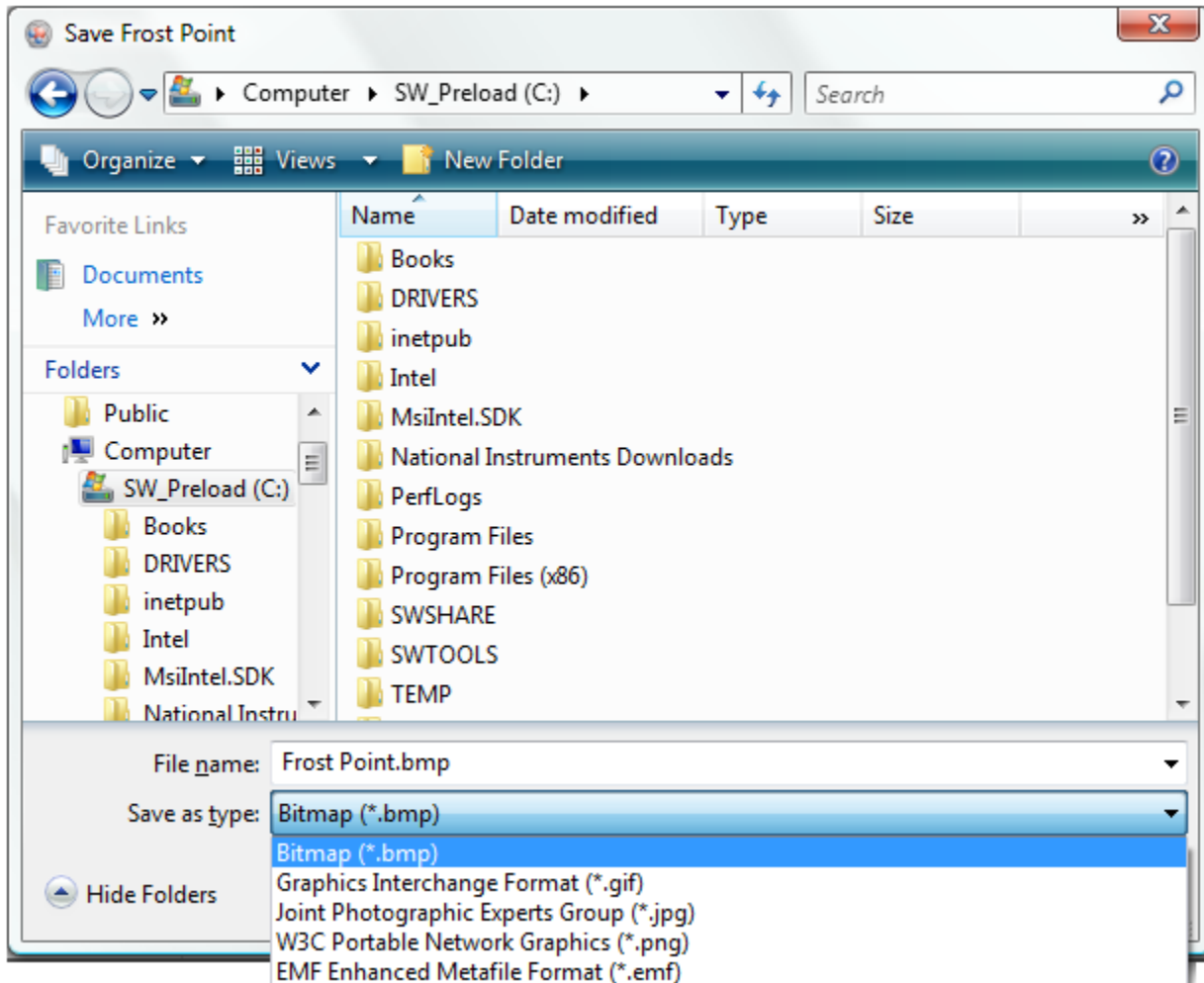

8 DATA AND DATA SUMMARY

ControLog stores data into individual Data Tabs. Each data tab contains a spreadsheet type view that consists of a date/time stamp and the measured data items corresponding to that date/time stamp. Data tabs consist of three similar but different types: Device Data, File Data and Data Summary. Each type has the same spreadsheet type view and operation, but all three have different data sources.

Note - The data tab data is always stored in SI units regardless of the current system unit settings. The only exception is for Data Summary tabs which are created using currently selected system units but will not update on further unit changes.

Date/Time Stamp	Saturation Pressure Setpoint [Pa]	Saturation Pressure [Pa]	Saturation Pressure [Pa]
11/6/2017 4:40:37 PM	119265.85	139440.82	
11/6/2017 4:41:07 PM			
11/6/2017 4:41:37 PM			
11/6/2017 4:42:07 PM			
11/6/2017 4:42:37 PM	1360.3003	139302.09	
11/6/2017 4:43:07 PM	1202.2568	138843.15	
11/6/2017 4:43:37 PM	2109.0993	139995.69	
11/6/2017 4:44:07 PM	1685.935	139536.63	
11/6/2017 4:44:37 PM	1900.1705	139471.19	
11/6/2017 4:45:07 PM	1684.3347	139537.81	
11/6/2017 4:45:37 PM	1074.9511	139150.28	
11/6/2017 4:46:07 PM		139083.18	
11/6/2017 4:46:37 PM		139175.79	
11/6/2017 4:47:07 PM		139761.74	
11/6/2017 4:47:37 PM		139668.01	
11/6/2017 4:48:07 PM	1956.4622	139678.2	
11/6/2017 4:48:37 PM	1570.1561	139464.62	
11/6/2017 4:49:07 PM	1712.3427	139498.89	
11/6/2017 4:49:37 PM	1572.2231	139462.03	
11/6/2017 4:50:07 PM	1353.6359	139092.49	
11/6/2017 4:50:37 PM	1860.5553	139699.14	
11/6/2017 4:51:07 PM	1860.5553	139699.14	

The user can navigate through the data using the scroll bars .

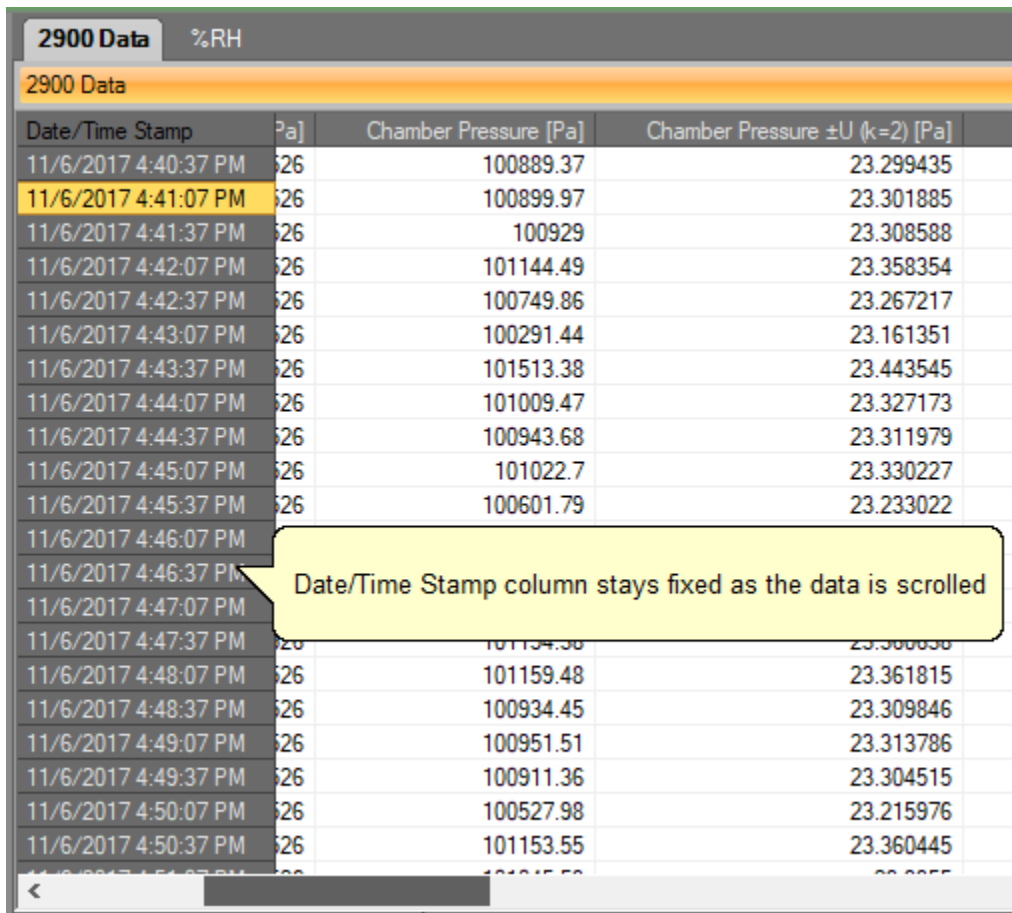

The screenshot shows a data table titled "2900 Data" with a sub-header "%RH". The table has four columns: "Date/Time Stamp", "Pa]", "Chamber Pressure [Pa]", and "Chamber Pressure ±U (k=2) [Pa]". The data rows show various pressure readings over time on 11/6/2017. A yellow callout box points to the "Date/Time Stamp" column, stating "Date/Time Stamp column stays fixed as the data is scrolled".

Date/Time Stamp	Pa]	Chamber Pressure [Pa]	Chamber Pressure ±U (k=2) [Pa]
11/6/2017 4:40:37 PM	626	100889.37	23.299435
11/6/2017 4:41:07 PM	626	100899.97	23.301885
11/6/2017 4:41:37 PM	626	100929	23.308588
11/6/2017 4:42:07 PM	626	101144.49	23.358354
11/6/2017 4:42:37 PM	626	100749.86	23.267217
11/6/2017 4:43:07 PM	626	100291.44	23.161351
11/6/2017 4:43:37 PM	626	101513.38	23.443545
11/6/2017 4:44:07 PM	626	101009.47	23.327173
11/6/2017 4:44:37 PM	626	100943.68	23.311979
11/6/2017 4:45:07 PM	626	101022.7	23.330227
11/6/2017 4:45:37 PM	626	100601.79	23.233022
11/6/2017 4:46:07 PM	626	101154.38	23.366638
11/6/2017 4:46:37 PM	626	101159.48	23.361815
11/6/2017 4:47:07 PM	626	100934.45	23.309846
11/6/2017 4:47:37 PM	626	100951.51	23.313786
11/6/2017 4:48:07 PM	626	100911.36	23.304515
11/6/2017 4:48:37 PM	626	100527.98	23.215976
11/6/2017 4:49:07 PM	626	101153.55	23.360445
11/6/2017 4:49:37 PM	626	101153.55	23.360445

The user can also select specific data by clicking and dragging the desired cells.

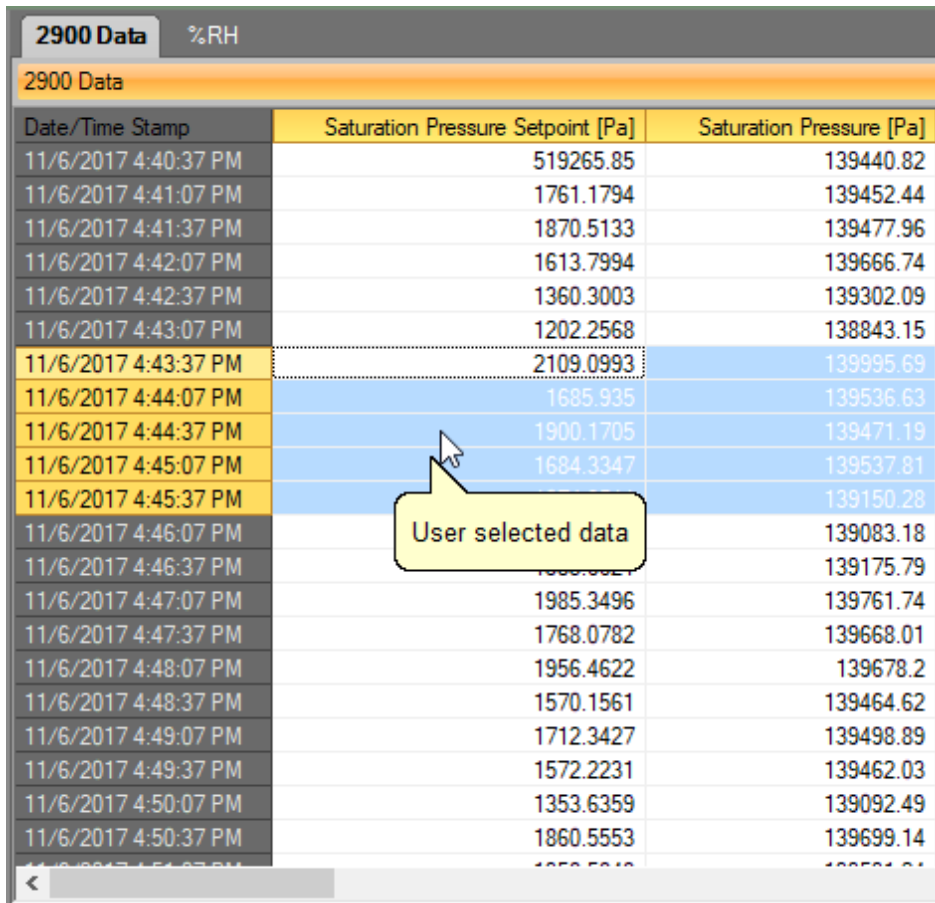

The screenshot shows a data table titled "2900 Data" with a "%RH" label. The table has three columns: "Date/Time Stamp", "Saturation Pressure Setpoint [Pa]", and "Saturation Pressure [Pa]". A range of data is highlighted in blue, and a yellow callout box with a mouse cursor icon points to the first row of this range, containing the text "User selected data".

Date/Time Stamp	Saturation Pressure Setpoint [Pa]	Saturation Pressure [Pa]
11/6/2017 4:40:37 PM	519265.85	139440.82
11/6/2017 4:41:07 PM	1761.1794	139452.44
11/6/2017 4:41:37 PM	1870.5133	139477.96
11/6/2017 4:42:07 PM	1613.7994	139666.74
11/6/2017 4:42:37 PM	1360.3003	139302.09
11/6/2017 4:43:07 PM	1202.2568	138843.15
11/6/2017 4:43:37 PM	2109.0993	139995.69
11/6/2017 4:44:07 PM	1685.935	139536.63
11/6/2017 4:44:37 PM	1900.1705	139471.19
11/6/2017 4:45:07 PM	1684.3347	139537.81
11/6/2017 4:45:37 PM		139150.28
11/6/2017 4:46:07 PM		139083.18
11/6/2017 4:46:37 PM		139175.79
11/6/2017 4:47:07 PM	1985.3496	139761.74
11/6/2017 4:47:37 PM	1768.0782	139668.01
11/6/2017 4:48:07 PM	1956.4622	139678.2
11/6/2017 4:48:37 PM	1570.1561	139464.62
11/6/2017 4:49:07 PM	1712.3427	139498.89
11/6/2017 4:49:37 PM	1572.2231	139462.03
11/6/2017 4:50:07 PM	1353.6359	139092.49
11/6/2017 4:50:37 PM	1860.5553	139699.14

The user can then copy selected data to the clipboard by selecting “Copy Selection” from the context menu or by using the keyboard shortcut combination of Ctrl+C.

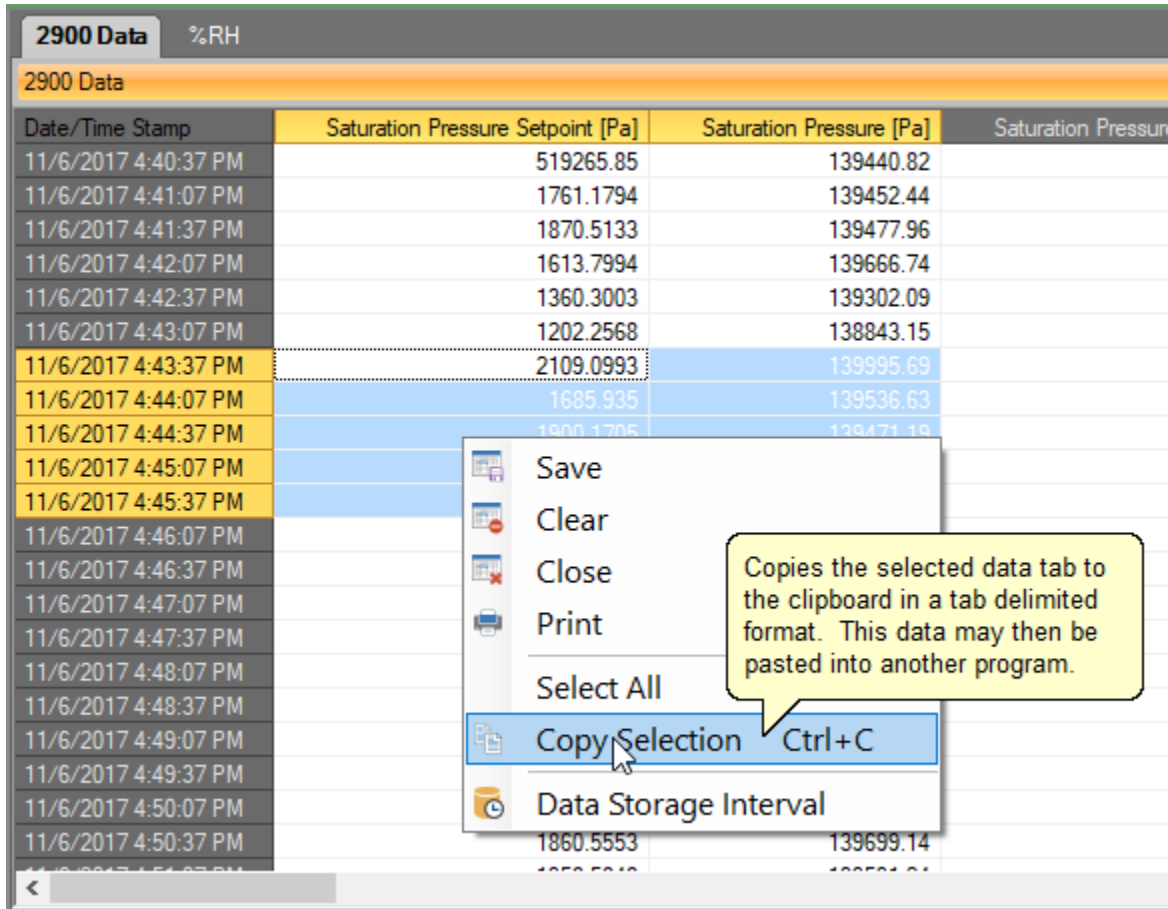

8.1 DEVICE DATA TABS

The Device Data Tabs contain stored data values obtained by the connected generator or device. After establishing communication with the generator or device an individual data tab for the device will be created. These tabs store the data readings from the connected device at the specified data storage interval.

Note - Data is only recorded while the 2900 is in generate mode. Data is also stored at the generate rate whenever a device is connected and the 2900 is not connected. This gives the user the ability to use ControLog as a logging application for any device they connect without the need of a Model 2900 Humidity generator.

Date/T	Dew Point [C]
11/7/2017 11:15:09	17.81135
11/7/2017 11:16:09	17.81226
11/7/2017 11:16:39	17.81465
11/7/2017 11:17:09	17.82515
11/7/2017 11:17:39	17.8139
11/7/2017 11:18:09	17.8129
11/7/2017 11:18:39	17.81361
11/7/2017 11:19:09	17.80954
11/7/2017 11:19:39	17.82289
11/7/2017 11:20:09	17.84654
11/7/2017 11:20:39	17.86752
11/7/2017 11:21:09	17.86788
11/7/2017 11:21:39	17.85679
11/7/2017 11:22:09	17.85888
11/7/2017 11:22:39	17.88114
11/7/2017 11:23:09	17.88266
11/7/2017 11:23:39	17.86886
11/7/2017 11:24:09	17.87359
11/7/2017 11:24:39	17.88568
11/7/2017 11:25:09	17.9035
11/7/2017 11:25:39	17.89565
11/7/2017 11:26:09	17.8855

8.2 FILE DATA TABS

The File Data Tabs contain data values loaded from a previously saved Device Data Tab. ControLog can open data saved in the following types and formats:

- Text File (Comma Delimited) (*.csv;*.txt)
- Text File (Tab Delimited) (*.dat;*.txt)
- Excel Workbook (*.xlsx;*.xls)
- Backup ControLog File (*.backup)

The only requirement for loading data from the above-mentioned data files is the data must be formatted so date/time values appear in the first column and all other columns contain numeric values.

To open a data file, select “Open>Data File” from the file menu.

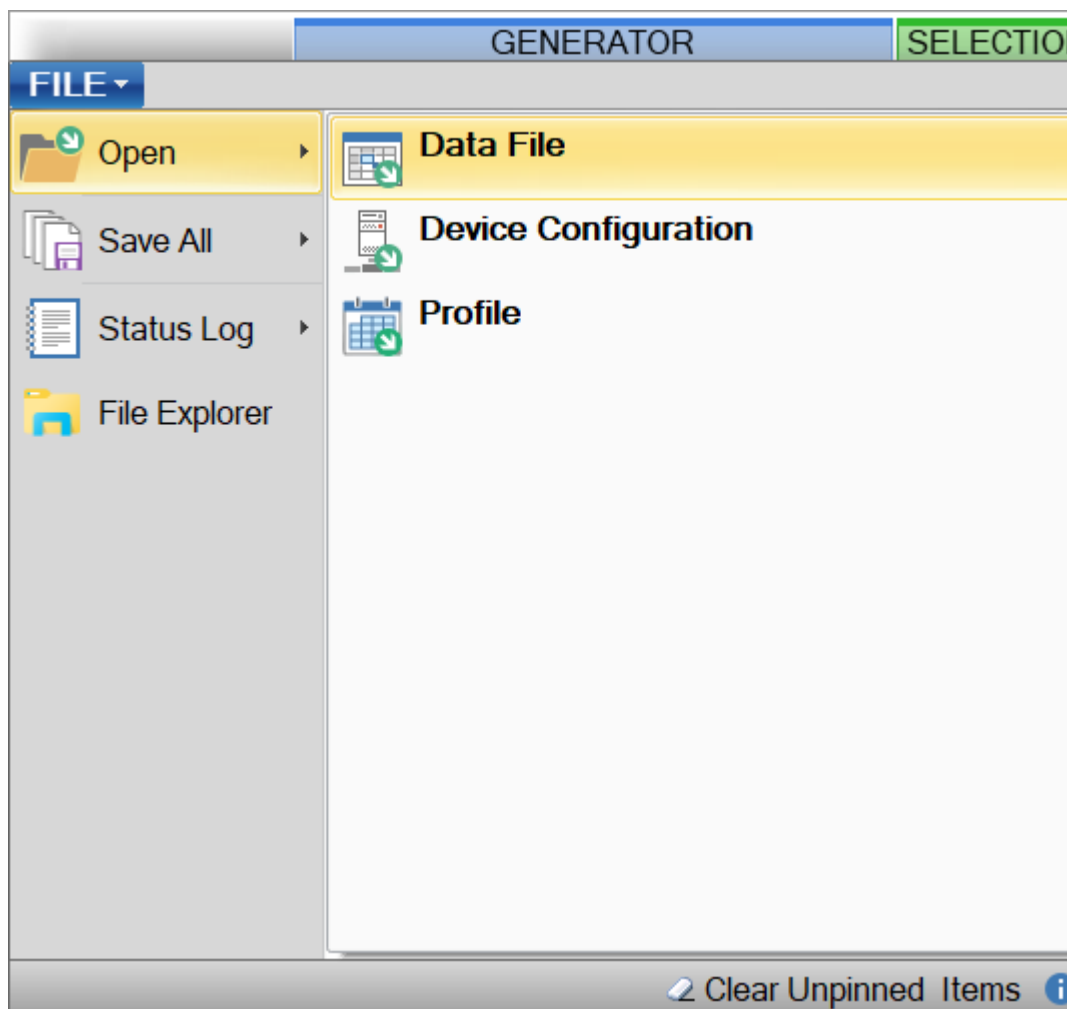

Note - ControLog has a limit of five file data tabs opened at any given time.

Using the “Load Data File” dialog, browse and select the data file you want to open.

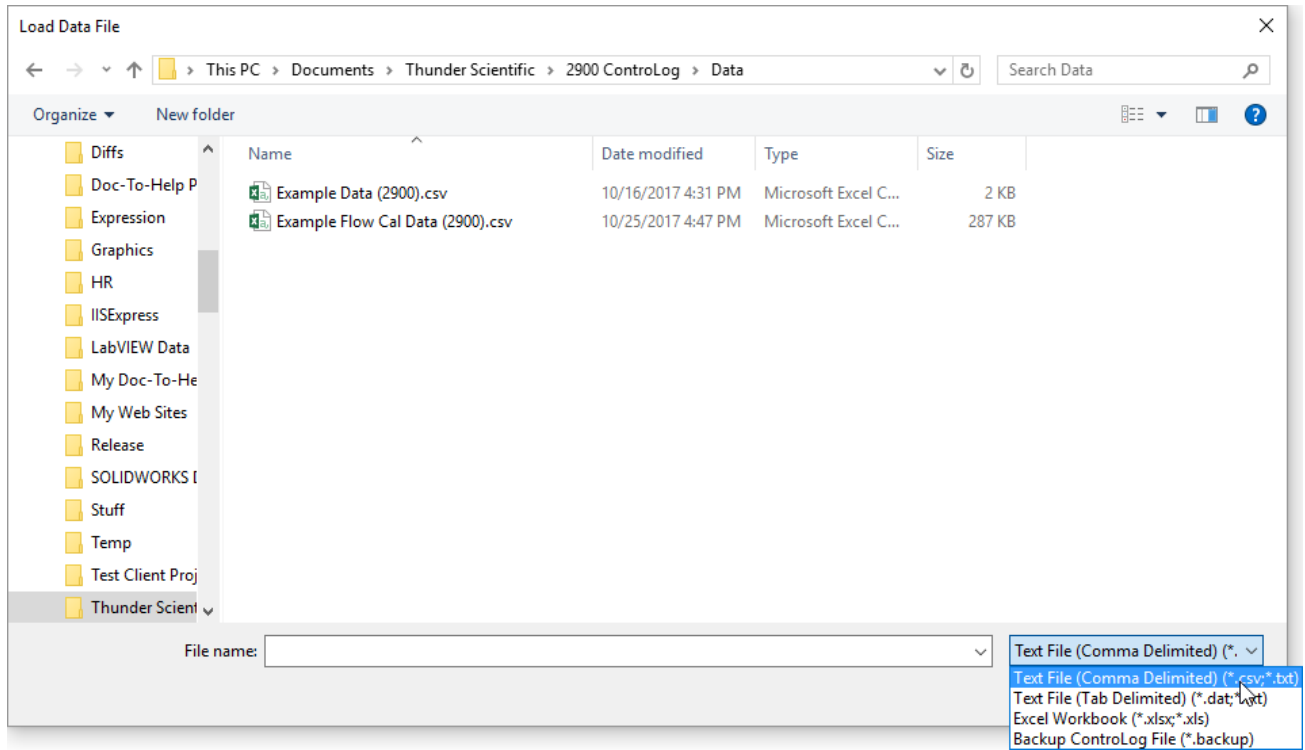

Once the load is complete the loaded file data tab will be displayed.

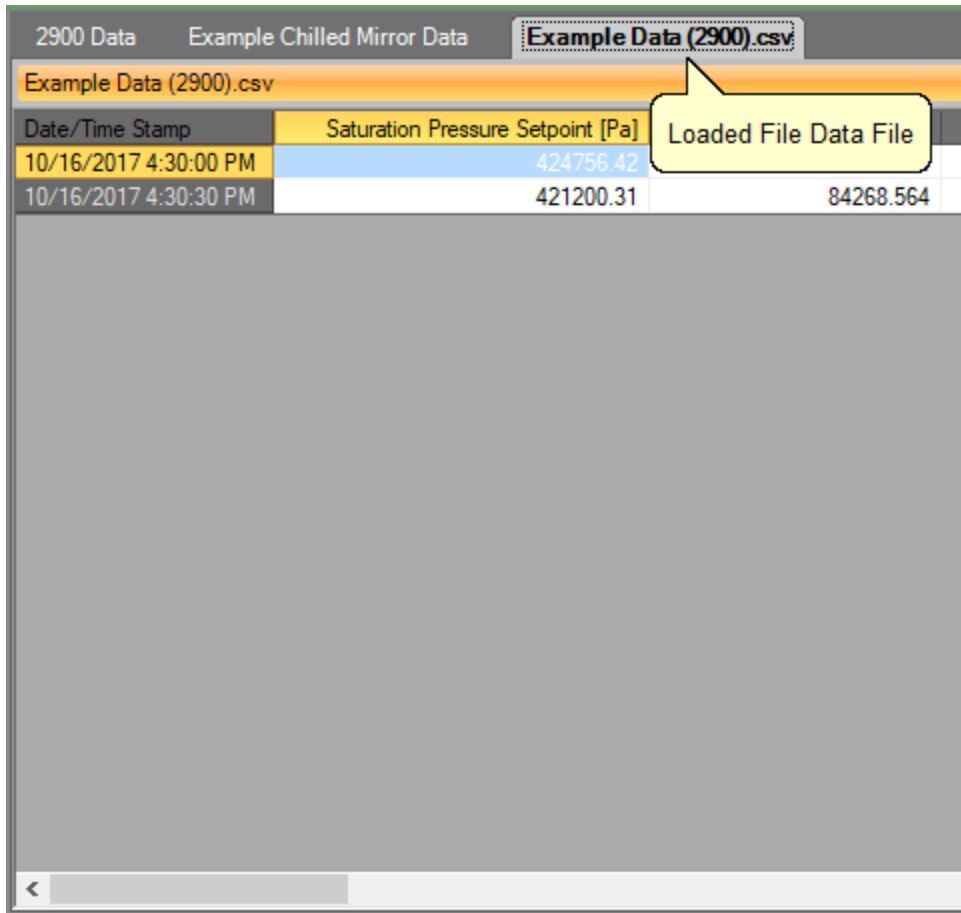

The screenshot shows a software interface with a tabbed view. The active tab is 'Example Data (2900).csv', which is highlighted in orange. A yellow callout box with a pointer to the tab contains the text 'Loaded File Data File'. Below the tab is a table with the following data:

Date/Time Stamp	Saturation Pressure Setpoint [Pa]	
10/16/2017 4:30:00 PM	424756.42	
10/16/2017 4:30:30 PM	421200.31	84268.564

The table is followed by a large grey rectangular area, likely a plot or graph, which is currently empty. A scroll bar is visible at the bottom left of the interface.

8.3 DATA SUMMARY TABS

The Data Summary Tabs contain data values generated from a Data Summary. The data summary allows the user to summarize the available data into a single data tab. The data summary also allows the user to calculate error or differences between a selected standard values and selected device values.

Note - Data Summary tabs are created using the currently selected system units instead of SI units. ControLog has a limit of five data summary tabs opened at any given time.

Date/Time Stamp			Example Chilled Mirror: Dew P
11/9/2017 11:34:05 AM			
11/9/2017 11:35:05 AM		17.153051	17.
11/9/2017 11:36:05 AM		17.189423	17.
11/9/2017 11:37:05 AM		17.22729	17.
11/9/2017 11:38:05 AM		17.234287	17.
11/9/2017 11:39:05 AM		17.194623	17.
11/9/2017 11:40:05 AM		17.18458	17.
11/9/2017 11:41:05 AM		17.179354	17.
11/9/2017 11:42:05 AM		17.165301	17.
11/9/2017 11:43:05 AM		17.165969	17.
11/9/2017 11:44:05 AM		17.171517	17.
11/9/2017 11:45:05 AM		17.165232	17.
11/9/2017 11:46:05 AM		17.15082	17.
11/9/2017 11:47:05 AM		17.164257	17.
11/9/2017 11:48:05 AM		17.146481	17.
11/9/2017 11:49:05 AM		17.190284	17.
11/9/2017 11:50:05 AM		17.237839	17.
11/9/2017 11:51:05 AM		17.258794	17.
11/9/2017 11:52:05 AM		17.257545	17.
11/9/2017 11:53:05 AM		17.258232	17.

8.3.1 Creating a Data Summary

To create a Data Summary, select “Create Data Summary” from the Home ribbon menu tab. Selection will open the Data Summary Wizard dialog that will step the user through the creation process.

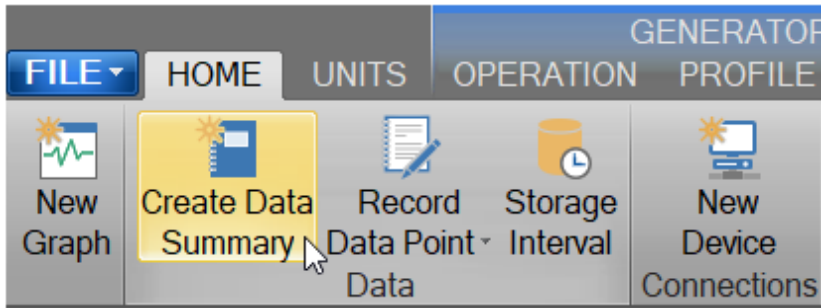

The first step in the data summary creation process is to give the data summary a name. This will be the name of the tab that appears in the Data and Graph Tab Group.

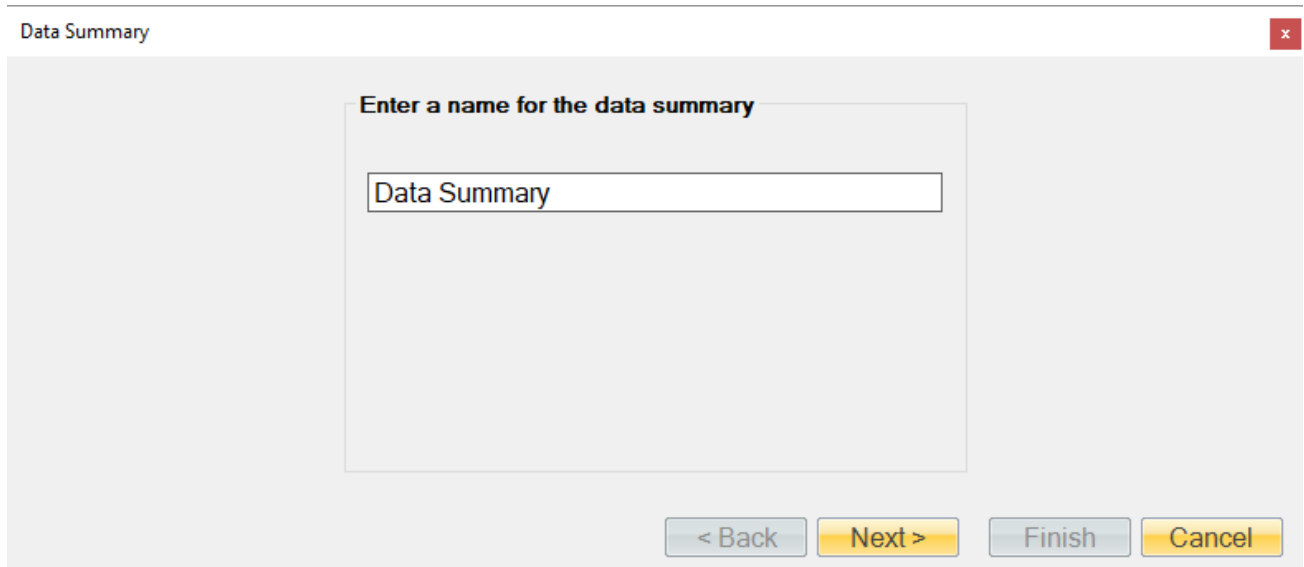

The next step in the data summary creation process is to select the standard. The standard will be used as the reference to calculate differences between the device data items if the user chooses to do so.

On the left-hand side is the available devices to choose from and on the right-hand side is the selected standard to add to the summary. To select a device, highlight it and click the “Add” button. In almost all cases the standard will be the 2900.

Note - Only one device can be selected as the standard for the summary.

Data Summary ✕

Select the standard to include in the summary:

Select the single standard to include in the summary. In most cases the standard will be the generator, but can be any device with available data. The standard will be used as the reference to calculate differences between device data items.

Available Standards:

- 2900
- Example Chilled Mirror

Standard to add to the summary:

+

ADD

–

REMOVE

< Back Next > Finish Cancel

To remove an item as the selected standard, select the desired item from the right-hand side and click the “Remove” button.

Data Summary ✕

Select the standard to include in the summary:

Select the single standard to include in the summary. In most cases the standard will be the generator, but can be any device with available data. The standard will be used as the reference to calculate differences between device data items.

Available Standards:

- 2900
- Example Chilled Mirror

Standard to add to the summary:

- 2900

+

ADD

–

REMOVE

< Back Next > Finish Cancel

Once complete, selecting the “Next” button will allow the user to select each device they would like to include in the summary. On the left-hand side are the available devices to choose from and on the right-hand side are the selected devices to add to the summary. To select a device, highlight it and click the “Add” button.

Note - Multiple devices can be selected and added to the summary.

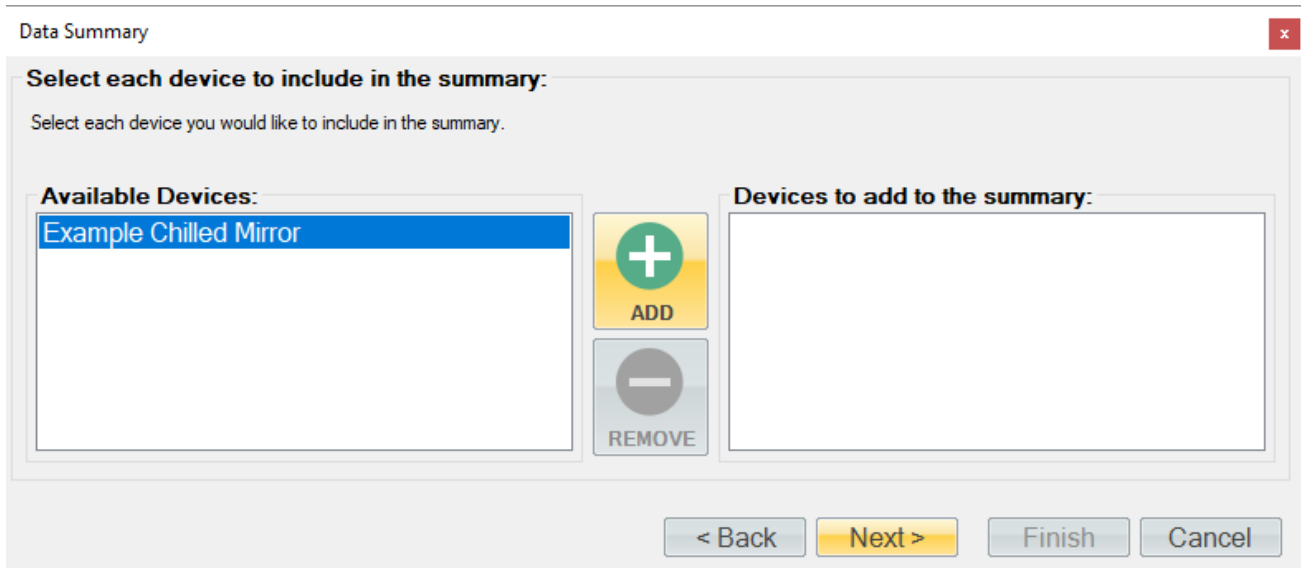

Note - The user can invert any selection by right clicking. This will highlight all items that are not currently highlighted and will remove highlight from any items that are currently highlighted.

To remove an item from the list of devices, select the desired item or items from the right-hand side and click the “Remove” button.

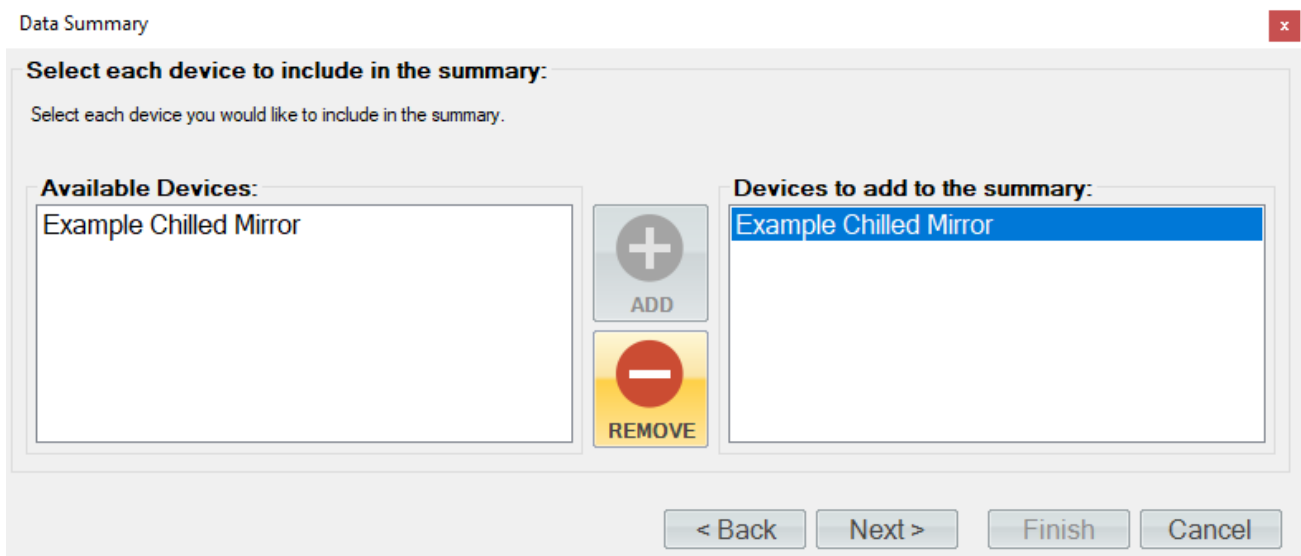

Once complete, selecting the “Next” button will allow the user to select the standard’s data items they would like to include in the summary. On the left-hand side are the available data items to choose from and on the right-hand side are the selected data items to add to the summary. To select a data item or items, highlight them and click the “Add” button.

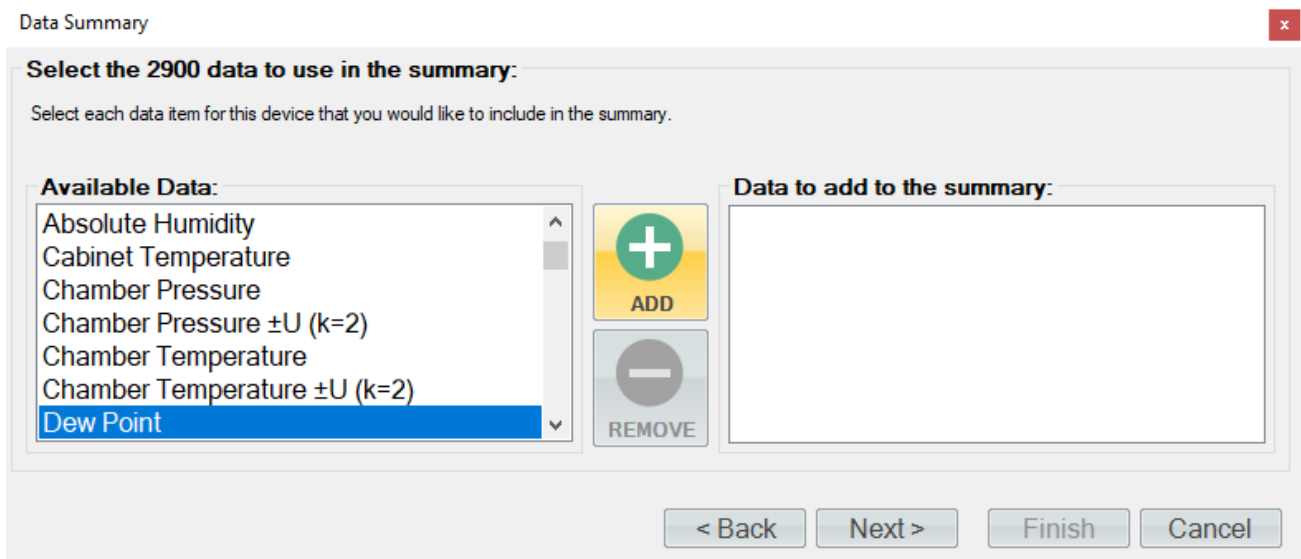

To remove an item or items from the list of data items, select the desired item or items from the right-hand side and click the “Remove” button.

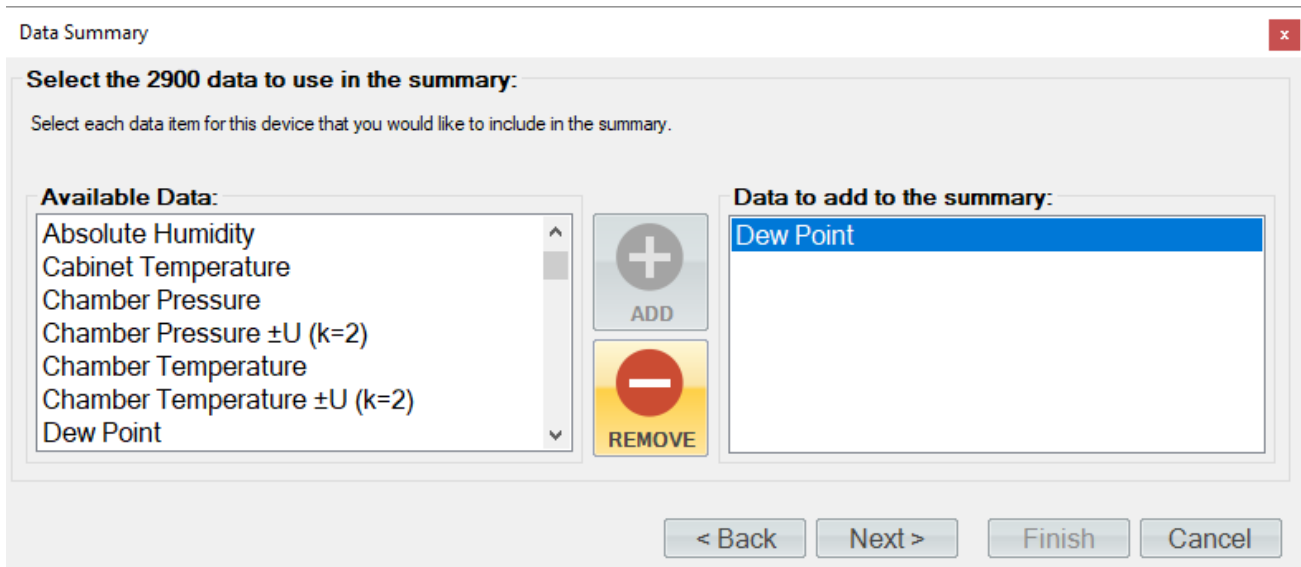

Selecting the “Next” button will repeat the process of selecting data for the next device in the series. This will continue until the user defines all the device data, they wish to include in the data summary.

The screenshot shows a window titled "Data Summary" with a close button in the top right corner. The main heading is "Select the Example Chilled Mirror data to use in the summary:". Below this is a sub-heading "Select each data item for this device that you would like to include in the summary." The interface is divided into two main sections: "Available Data:" on the left and "Data to add to the summary:" on the right. In the "Available Data:" list, "Dew Point" is selected and highlighted in blue. Between the two lists are two buttons: a yellow "ADD" button with a green plus sign and a grey "REMOVE" button with a grey minus sign. At the bottom of the window are four buttons: "< Back", "Next >", "Finish", and "Cancel".

Once the user has completed selecting data, ControLog will ask the user to pair each device data item with its corresponding standard data item. This tells ControLog which device data item corresponds with which standard data item so that a difference can be calculated and the error between the standard and the device can be included in the summary. If the user does not desire to calculate error for a particular data item, they simple need not pair it.

To pair a data item, select the desired device data item and the standard data item you would like to pair it with. Select “Add” to create the pairing.

The screenshot shows a window titled "Data Summary" with a close button in the top right corner. The main heading is "Pair the Example Chilled Mirror data with its corresponding 2900 data:". Below this is a sub-heading "Pair each device data item with its corresponding standard data item. This tells the ControLog which device data item corresponds with which standard data item so that a difference can be calculated to show the error between the standard and the device. If you do not desire to calculate error for a particular data item then simply do not pair it." The interface is divided into three main sections: "Device Data:" on the left, "Standard Data:" in the middle, and "Paired Data:" on the right. In both the "Device Data:" and "Standard Data:" lists, "Dew Point" is selected and highlighted in blue. Between the "Device Data:" and "Standard Data:" lists are two buttons: a yellow "ADD" button with a green plus sign and a grey "REMOVE" button with a grey minus sign. At the bottom of the window are four buttons: "< Back", "Next >", "Finish", and "Cancel".

To remove a data item pairing, select the desired pair or pairings from the right-hand side and click the “Remove” button.

The screenshot shows a window titled "Data Summary" with a close button (X) in the top right corner. The main heading is "Pair the Example Chilled Mirror data with its corresponding 2900 data:". Below this is a paragraph of instructions: "Pair each device data item with its corresponding standard data item. This tells the ControLog which device data item corresponds with which standard data item so that a difference can be calculated to show the error between the standard and the device. If you do not desire to calculate error for a particular data item then simply do not pair it." There are three columns: "Device Data:" containing "Dew Point", "Standard Data:" containing "Dew Point", and "Paired Data:" containing "Dew Point = Dew Point". Between the first two columns are two buttons: a grey "ADD" button with a plus sign and a yellow "REMOVE" button with a minus sign. At the bottom are four buttons: "< Back", "Next >", "Finish", and "Cancel".

Selecting the “Next” button will repeat the process of pairing data for the next device in the series. This will continue until the user defines all the desired data pairs, they wish to include in the data summary.

Once data pairing is complete, the user will be asked to select the time range and interval that the data summary will cover. The selected device’s time range will be used to determine which points to include. The data will begin at the closest point to the selected start time and will end at the closest point to the selected end time. The summary will include all available data points between the start and end times at the closest points to the specified interval. If a particular device does not have a corresponding time for a given base time, then the value fields will be left blank for that device for that given time.

Note - For manual devices, it is recommended to select the manual device as the bases for the time range to use. It is also recommended to select a small time interval (1 second) to assure all data is encompassed because often manual devices have irregular time intervals between points.

The screenshot shows a window titled "Data Summary" with a close button (X) in the top right corner. The main heading is "Select the time range the summary will cover:". Below this is a paragraph of instructions: "Select the device for which you want to base the data summary’s time range on. The data will begin at the closest point to the selected start time and will end at the closest point to the selected end time. The summary will include all available data points between the start and end times at the closest points to the specified interval." There are three main sections: "Device Time Range to Use:" with a list box containing "2900" (highlighted) and "Example Chilled Mirror"; "Start Time:" with a time picker set to "11/09/17 1:36:05 PM"; "End Time:" with a time picker set to "11/09/17 1:47:05 PM"; and "Time Interval:" with a numeric input set to "1" and a dropdown menu set to "minutes". A note on the right states: "Note: For manual devices it is recommended to select the manual device as the bases of the time range. It is also recommended to select a small time interval (1 second) to assure all data is encompassed because often manual devices have irregular time intervals between points." At the bottom are four buttons: "< Back", "Next >", "Finish", and "Cancel".

Upon clicking the “Finish” button, ControLog will open a new data tab with the newly created data summary.

Date/Time Stamp	2900: Dew Point [C]	Example Chilled Mirror: Dew Point [C]	Example Chilled Mirror: Dew Point Error [C]
11/9/2017 1:36:05 PM	17.497102	17.49518	-0.0019224304
11/9/2017 1:37:05 PM	17.525208	17.52539	
11/9/2017 1:38:05 PM	17.522631	17.52276	
11/9/2017 1:39:05 PM	17.528598	17.52798	
11/9/2017 1:40:05 PM	17.531809	17.53175	
11/9/2017 1:41:05 PM	17.505204	17.5052	-4.2293522E-06
11/9/2017 1:42:05 PM	17.546119	17.54543	-0.0006889728
11/9/2017 1:43:05 PM	17.54874	17.54837	-0.00037006242
11/9/2017 1:44:05 PM	17.55435	17.55337	-0.00098028453
11/9/2017 1:45:05 PM	17.565473	17.56427	-0.0012026203
11/9/2017 1:46:05 PM	17.562702	17.56302	0.00031841721
11/9/2017 1:47:05 PM	17.578991	17.57899	-6.079905E-07

8.4 RECORDED DATA POINTS TAB

The Recorded Data Points Tab contains the recorded data points that have been taken either manually by the user, after a manual device entry or at the completion of a soak phase during an auto profile. Each data point can also calculate the average and or standard deviation for the defined number of prior points taken with each recorded data point.

Note - Each entry point in the Recorded Data Points tab is created using the currently selected system units.

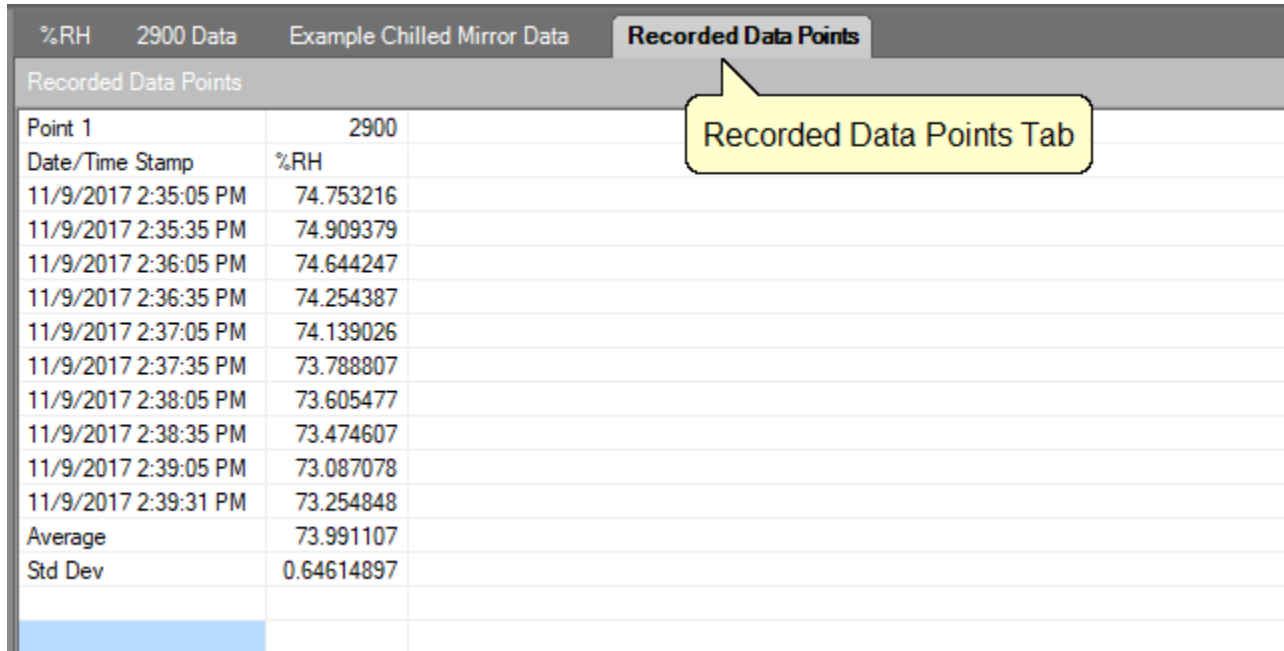

Recorded Data Points	
Point 1	2900
Date/Time Stamp	%RH
11/9/2017 2:35:05 PM	74.753216
11/9/2017 2:35:35 PM	74.909379
11/9/2017 2:36:05 PM	74.644247
11/9/2017 2:36:35 PM	74.254387
11/9/2017 2:37:05 PM	74.139026
11/9/2017 2:37:35 PM	73.788807
11/9/2017 2:38:05 PM	73.605477
11/9/2017 2:38:35 PM	73.474607
11/9/2017 2:39:05 PM	73.087078
11/9/2017 2:39:31 PM	73.254848
Average	73.991107
Std Dev	0.64614897

8.4.1 How to Record a Data Point

To Record a Data Point, select “Record Data Point” from the main menu or right click a data tab and select “Record Data Point”.

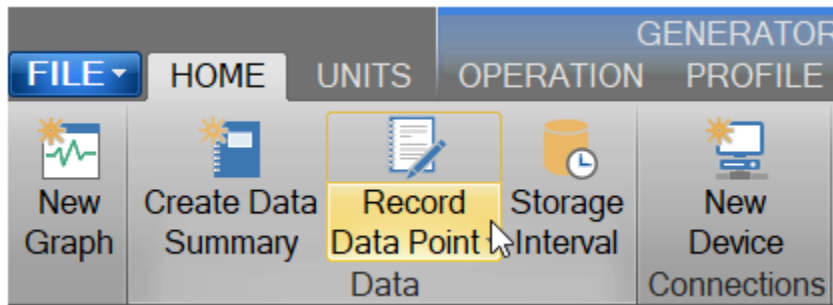

The first step in recording data points is to configure what and how to take each point. Use the Settings menu to open the Record Data Point Wizard to define the data points to be taken.

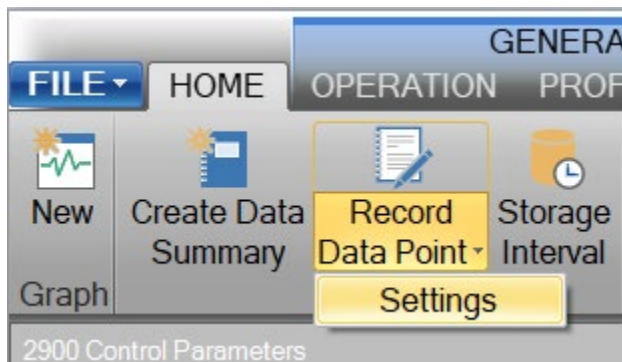

A “Record Data Point Wizard” dialog will appear.

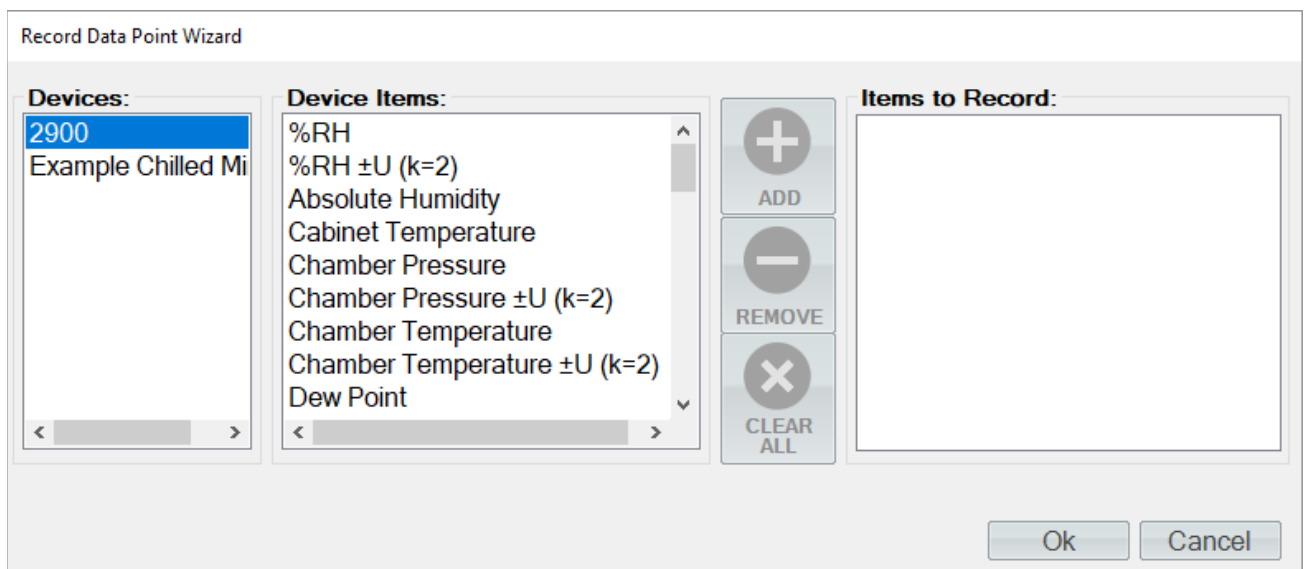

The first page of the Record Data Point Wizard is where the user selects which device items they would like record. On the left-hand side is a list of all available devices. Selecting a device will result in the “Device Items” list being updated to reflect the available items for the selected device. To add an item, highlight the desired item or items in the “Device Items” list and click the “Add” button.

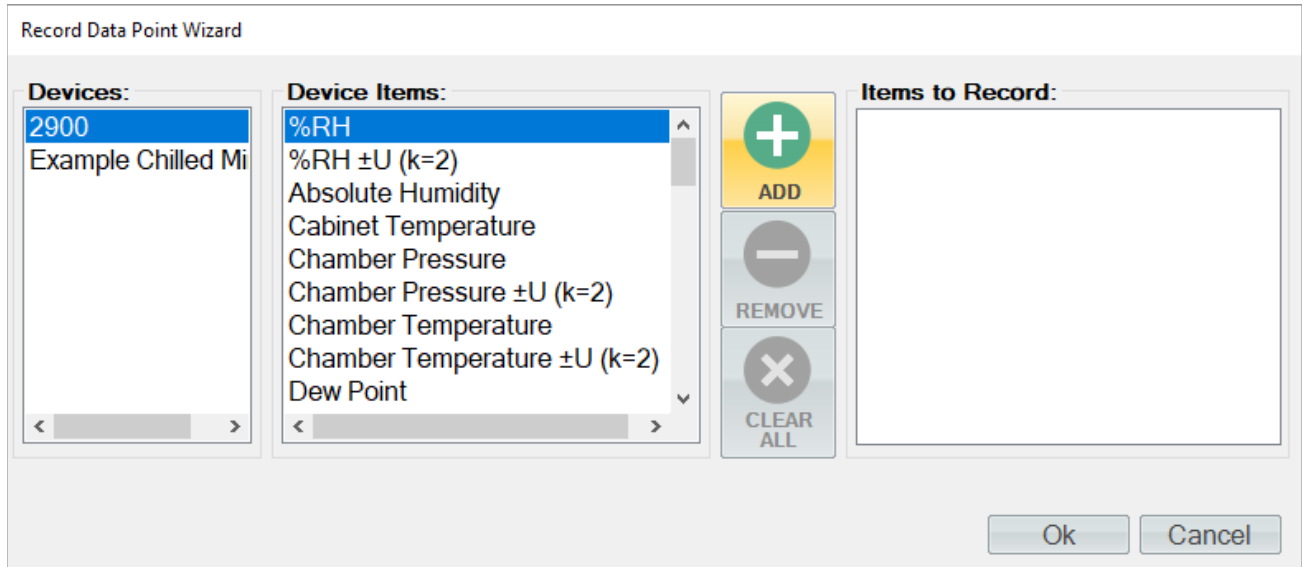

Repeat this process until all the desired items are listed on the right side.

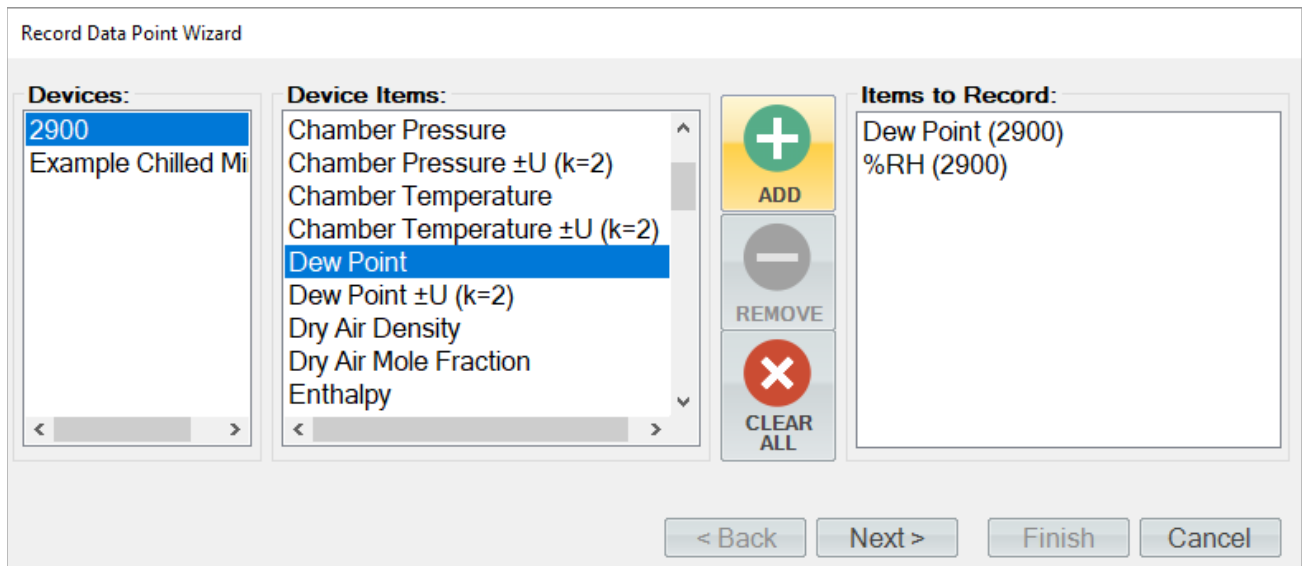

Note - The user can invert any selection by right clicking. This will highlight all items that are not currently highlighted and will remove highlight from any items that are currently highlighted.

To remove an item from the list of items to record, the user can either click the “Clear All” button to remove all items or simply select the desired item from the “Items to Record” list and click the “Remove” button.

Once complete, clicking the “Next” button will bring up the Properties page. From the properties page the user can define what will be recorded for each point.

Recording Properties define the number of prior (last) points to include and whether to calculate the average and or standard deviation for the defined number of prior points taken with each recorded data point.

- **Include the last ... points** defines the number of prior points to include with each recorded data point. The prior points are determined from the Data Tab for each point being recorded. ControLog will include the number of prior (last) points directly using the entries in the Data Tab for the given point from the time the data point was recorded.

- **Include Average** defines whether to include an average of the defined number of prior points for the recorded data items for each point taken.
- **Include Standard Deviation** defines whether to include the standard deviation of the defined number of prior points for the recorded data items for each point taken.

Once complete, clicking the “Next” button will bring up the frequency page. From the frequency page the user can define when and how to take a data point.

Recording Frequency defines when and how the system will take a data point. The user should select (place check mark) by each method they would like to use.

- **Manually** indicates that the user will manually take points when they want, using either the “Take Point” menu item or by pressing the Ctrl-P key combination on the keyboard when ControLog is the active window.
- **Automatically with each profile point** indicates that a point will be taken automatically at the completion of each profile soak phase.

Note - If the user manually bypasses the soak phase using the manual profile control buttons, an automatic point will NOT be taken regardless of the selection of “Automatically with each profile point” setting.

- **Automatically after manual device entry** indicates that a point will be taken automatically when the user completes a manual device entry.

Once complete, clicking the “Finish” will close the wizard and save the user selection for recording data points.

The screenshot shows a window titled "Recorded Data Points" with a table of recorded data. The table is organized into sections for different types of data points. Callouts provide additional information about each section.

Point 1			
Date/Time	Stamp	Dew Point [C]	%RH
11/9/		2900	2900
11/9/			
11/9/			
Average		17.983143	74.566303
Std Dev		0.01564995	0.0708842

Manual Device Entry Point 1			
Date/Time	Stamp	Dew Point [C]	%RH
11/9/		2900	2900
11/9/			
11/9/			
Average		17.995145	74.619818
Std Dev		0.0068374115	0.057839981

Profile Point 2			
Date/Time	Stamp	Dew Point [C]	%RH
11/9/		2900	2900
11/9/			
11/9/			

Callouts in the image:

- "All recorded data points will appear in the Recorded Data Points tab" (points to the window title)
- "Points taken manually by the user will be labeled 'Point' followed by the number taken" (points to 'Point 1')
- "Average and Standard Deviation can be calculated for each data item in each point" (points to the Average and Std Dev rows)
- "Points taken automatically after data entry for a manual device will be labeled 'Manual Device Entry Point' followed by the number taken" (points to 'Manual Device Entry Point 1')
- "Points taken automatically after an auto profile soak phase will be labeled 'Profile Point' followed by the profile point number" (points to 'Profile Point 2')

9 AUTO PROFILING

The Auto Profiling feature is very similar to the Generate mode with the main exception that profiling relies on a predefined list of setpoints referred to as a profile. The user configurable profile is used as ControLog's road map during Auto Profile operation. It defines which setpoint values to go to, at what rate to go from one setpoint to another, and how long to stay at a specific setpoint before moving to the next setpoint.

Note - Before attempting to operate the system in an Auto Profile mode, you should become thoroughly familiar with the manual Generate mode of operation.

The Profile Tab is used to create and modify auto profiles. The tab consist of drop downs, entry fields and a data grid.

2900 Data **Auto Profile** ×

Control Mode: %RH Mode

Point	Generator Mode	%RH	Temperature [°C]	Mass Flow Ra
1	Generate	20	25	40
2	Generate	30	5	40
3	Generate		! 25	40
4	Generate		25	40
*				

New Point Line

Warning

Status Log

Point Time: 00:00:00:00

The scrollbar at the bottom can be used to scroll to the remaining profile fields.

The screenshot shows a software interface for configuring an auto profile. At the top, the window title is "2900 Data Auto Profile". Below the title bar, there is a "Control Mode" dropdown menu set to "%RH". The main area contains a table with the following columns: "Point", "Fan Speed", "Ramp Time", "Soak Time", and "Assurance". The "Assurance" column has a dropdown menu with "Yes" selected and an "Edit" button. A yellow callout box labeled "Assurance Conditions" points to the Assurance column. Below the table, there is a large grey area, and at the bottom, a scrollbar with a hand icon pointing to it. The status bar at the bottom shows "Status Log" and "Point Time: 00:00:00:00".

Point	Fan Speed	Ramp Time	Soak Time	Assurance
1		0		Yes
2		0		No
3		0	minutes 60	No
4		0	minutes 60	No
*				

9.1 CREATING A NEW PROFILE

A profile is a list of humidity, temperature, pressure, flow, and time parameters that are used during automated control of the Model 2900 Humidity generator. The profile essentially programs the computer/controller operations.

Open a new profile tab by selecting “New” from the profile menu.

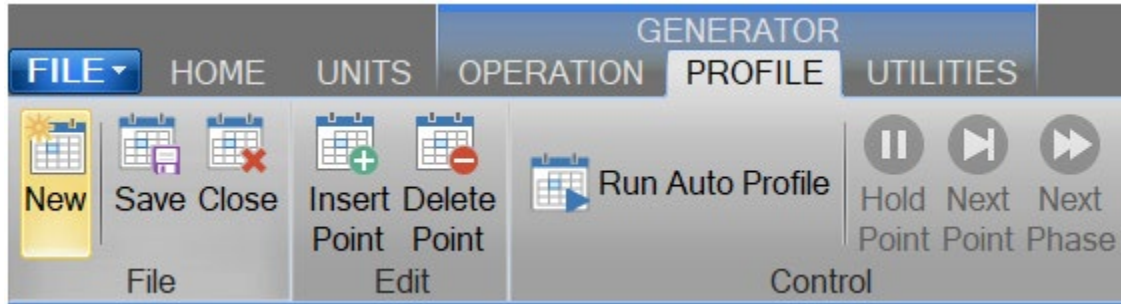

Select the desired **Control Mode** for the entire profile. The Control Mode is what the user would like to generate during the profile. The control modes are the same modes available during manual operation.

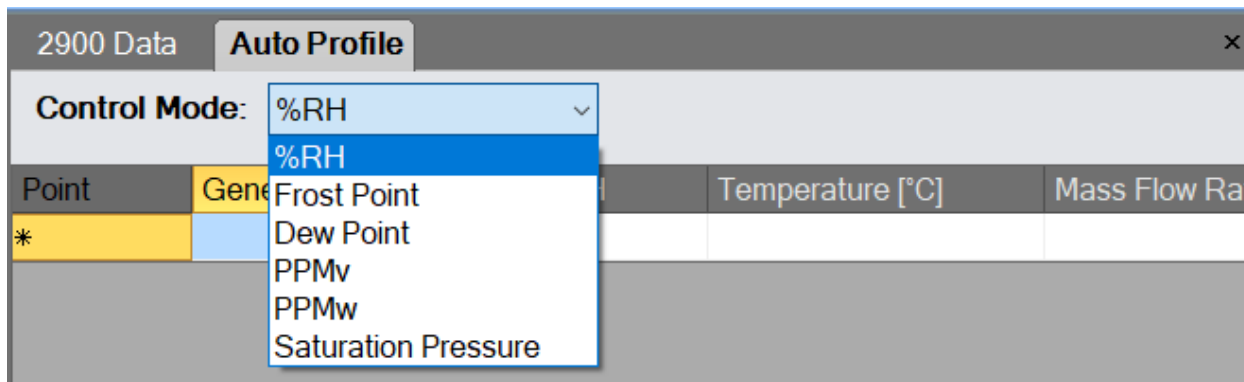

For more information, refer to section [4.1.4.1 Mode](#)

The first column, next to the point numbers, is the Generator Mode. The Generator Mode defines the run mode that the 2900 will operate in for this profile point. The Generator Modes are the same run modes available during manual operation.

Note - Shutdown is only available for the last point.

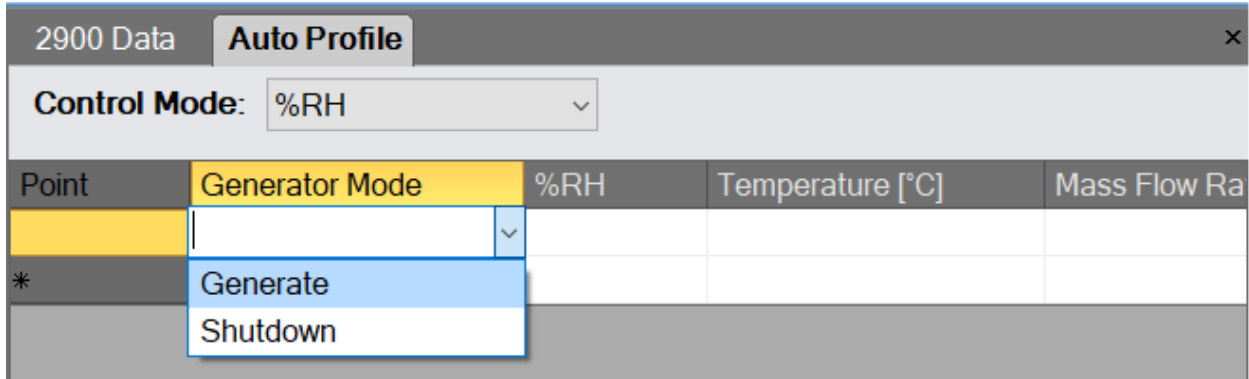

For more information, refer to section [4.1.4.2 Run Menu](#)

The first column next to the Generator Mode contains the humidity value to generate and is titled at the top according to the currently selected control mode. In the example shown, the profile control mode is set to %RH. Whenever the profile control mode is changed, the title on this column changes to reflect the control mode selected.

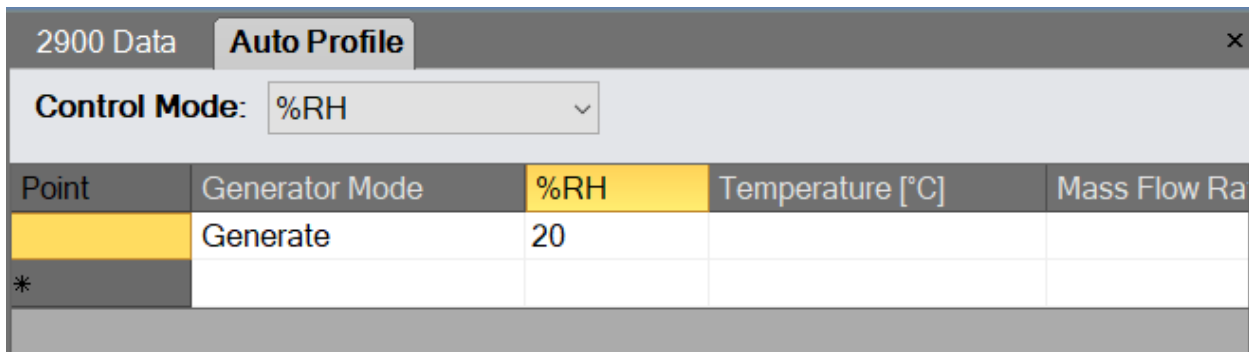

When the Control Mode is set to Saturation Pressure, the first column next to the Generator Mode contains the Saturation Pressure followed by the Temperature. In this control mode the user can also drop down a Mini version of HumiCalc to help calculate the desired Saturation Pressure by clicking the drop-down arrow on the cell. For example, let's say the user wants to calculate the required Saturation Pressure needed to generate a 50 %RH with a Saturation Temperature of 25.0 °C. Start by selecting Saturation Pressure as the Control Mode. Next, enter a 25.0 °C Temperature and then click the Saturation Pressure HumiCalc drop down at the right of the grid cell box.

The screenshot shows a software window titled "2900 Data Auto Profile". At the top, there is a "Control Mode:" label followed by a dropdown menu currently set to "Saturation Pressure". Below this is a table with the following structure:

Point	Generator Mode	Saturation Pressure [psia]	Temperature [°C]
1	Generate		25
*			

A yellow callout box with a pointer to the dropdown arrow in the "Temperature [°C]" cell of the first row contains the text "HumiCalc drop down".

Next, select the known to be %RH and enter the desired percent relative humidity of 50. Notice that ControLog automatically entered the other known values based on the already entered profile values.

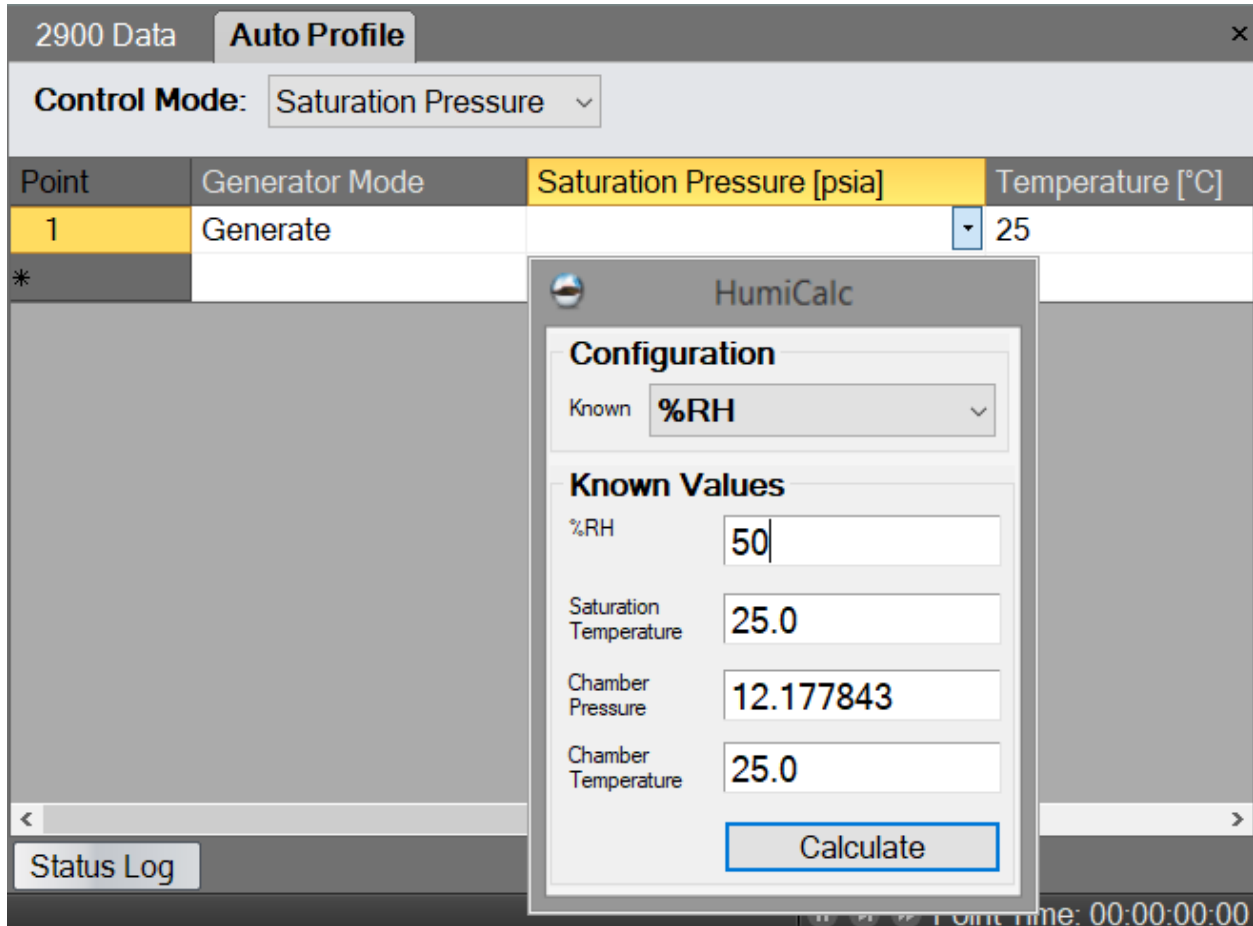

Clicking the “Calculate” button will result in the calculated Saturation Pressure being placed in the profile cell and the HumiCalc dropdown will close.

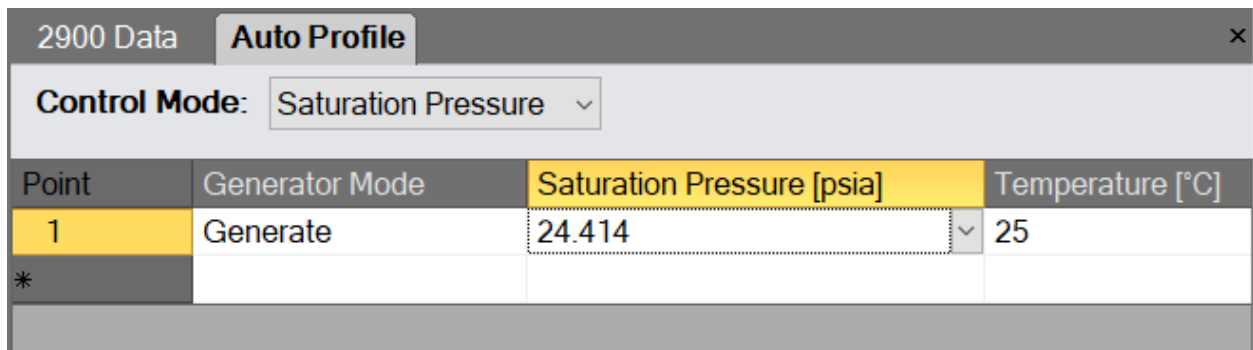

The Temperature column contains value for the saturation temperature for the given point.

2900 Data Auto Profile ×			
Control Mode: Saturation Pressure ▼			
Point	erator Mode	Saturation Pressure [psia]	Temperature [°C]
1	erate	24.414	25
*			

The Mass Flow Rate column contains values of the air flow at which the generator will operate. Although not affecting the generated value of humidity, flow rate does affect the air exchange rate, equilibration time of the instruments under test and permeation.

2900 Data Auto Profile ×			
Control Mode: Saturation Pressure ▼			
Point	on Pressure [psia]	Temperature [°C]	Mass Flow Rate [l/m]
1		25	40
*			

The Chamber Fan Speed column contains percent speed value of the chamber fan for the point. 0 meaning the fan is off and 100 meaning the fan is at full speed.

2900 Data Auto Profile ×			
Control Mode: Saturation Pressure ▼			
Point	emperature [°C]	Mass Flow Rate [l/m]	Chamber Fan Speed
1		40	50
*			

Ramp Time is the desired amount of time the 2900 should take to transition from one profile test point to another. Setting a ramp time of zero instructs the 2900 to make the transition as quickly as possible. Zero is the setting used for most profiles.

Note - *The first point cannot have a ramp time, because the starting setpoints can vary.*

The screenshot shows the '2900 Data Auto Profile' window. The 'Control Mode' is set to 'Saturation Pressure'. A table displays the following data for Point 1:

Point	Mass Flow Rate [l/m]	Chamber Fan Speed	Ramp Time
1	40	50	0
*			

A dropdown menu is open for the 'Ramp Time' cell, showing options: minutes, milliseconds, seconds, minutes (highlighted), hours, and days.

Soak Time is the desired amount of time to generate at a particular profile point. The soak time required depends on the application but should be a significant amount of time based upon the humidity devices being calibrated.

The screenshot shows the '2900 Data Auto Profile' window. The 'Control Mode' is set to 'Saturation Pressure'. A table displays the following data for Point 1:

Point	[m]	Chamber Fan Speed	Ramp Time	Soak Time
1		50	0	minutes 60
*				

A dropdown menu is open for the 'Soak Time' cell, showing options: minutes, milliseconds, seconds, minutes (highlighted), hours, and days.

Note - *Both Ramp Time and Soak Time are limited to a maximum time of 24.855 days. You likely to run out of water before this maximum time is ever reached.*

Assurance, if set to “Yes”, forces the system to wait until the measured values are within a specified tolerance and/or stability before ControlLog will start the Soak Phase. If “No” is set, the Soak Phase will start immediately upon completion of the Ramp Phase.

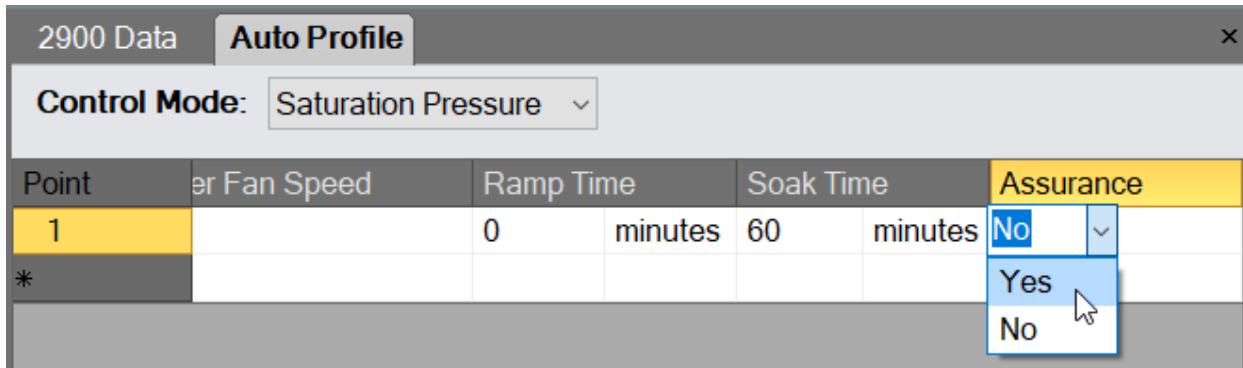

If Assurance is set to “Yes”, a small “Add” button will appear on the right-hand side.

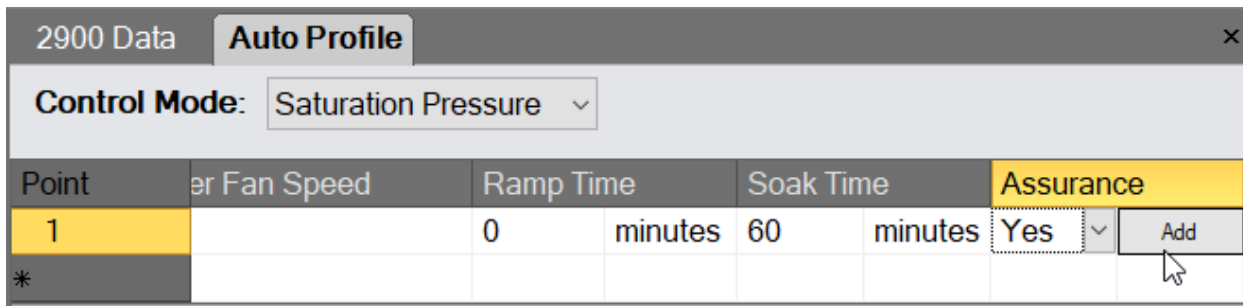

Clicking the “Add” button will open the “Assurance Conditions” dialog for the point. The dialog allows the user to enter various assurance conditions for the profile point.

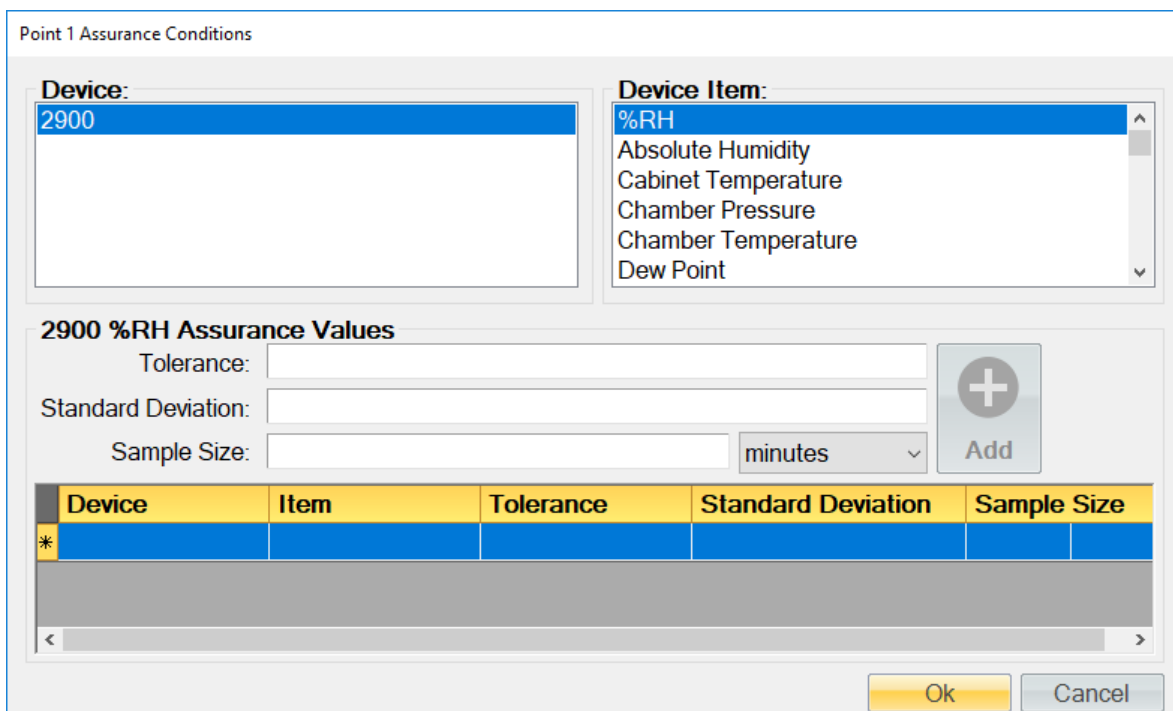

On the upper left-hand side is a list of all available devices. Clicking a device will result in the Device Items list being updated to reflect the available items for the selected device. To add an item, highlight the desired item in the Device Item list, enter the desired Tolerance and/or Standard Deviation and click the “Add” button. For quicker assurance times, increase the Tolerance and/or the Standard Deviation values. Tighter tolerances or standard deviations (smaller values) result in longer assurance times. Setting these values too small could prevent assurance conditions from being met, therefore preventing the system from advancing to the next profile point.

Point 1 Assurance Conditions

Device:
2900

Device Item:
%RH
Absolute Humidity
Cabinet Temperature
Chamber Pressure
Chamber Temperature
Dew Point

2900 %RH Assurance Values

Tolerance:

Standard Deviation:

Sample Size:

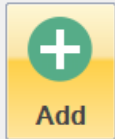
 Add

Device	Item	Tolerance	Standard Deviation	Sample Size
*				

Ok Cancel

The Tolerance is the allowable variation between the setpoint and the actual. This is best thought of as a window based on a minimum and maximum value, the minimum being the setpoint minus the tolerance and the maximum being the setpoint plus the tolerance. Once the actual value is within the window the tolerance portion of the condition is considered met.

Note - Tolerances can only be entered for 2900 setpoints. The field will be grayed out for all other non 2900 setpoint device items. This is because ControLog can only assure a tolerance for an item that it has the ability to control.

Standard Deviation is a statistic used to measure the variation in the actual data and can be thought of as how spread out or stable the data is. ControLog calculates the Standard Deviation from the device data tab for the points within the given **Sample Size**. When the actual standard deviation is less than the defined limit, the standard deviation portion of the condition is considered met.

Note - The sample size should always be carefully considered based on the data storage interval. Too small of a sample size in relation to the data storage interval will result in a small number of points used to calculate the Standard Deviation.

To update an assurance condition, select the desired condition from the list at the bottom, make the desired changes and select the Update button. To delete an assurance condition, select the desired condition from the list at the bottom and select the Delete button.

Point 1 Assurance Conditions

Device:
2900

Device Item:
%RH
Absolute Humidity
Cabinet Temperature
Chamber Pressure
Chamber Temperature
Dew Point

2900 %RH Assurance Values

Tolerance:

Standard Deviation:

Sample Size:

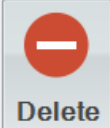
Device	Item	Tolerance	Standard Deviation	Sample Size
2900	%RH	±0.5	0.5	10.0 minutes
*				







Once all assurance conditions have been completed, select the “Ok” button to close the dialog.

Adding more points to the auto profile is the same process as entering the first point, but the user can let ControLog help fill in values for the new point by simply entering the desired values and then by selecting the new point line (indicated by the * asterisk). ControLog will predict values for any empty field by either copying the values from the point above or by continuing the pattern from the previous points. For example, if the previous %RH points were 20% and 50% ControLog will automatically use 80% for the next point if the user leaves that field empty.

2900 Data		Auto Profile		
Control Mode: %RH				
Point	Generator Mode	%RH	Temperature [°C]	Mass Flow Ra
1	Generate	20	25	40
2	Generate	50	25	40
3	Generate	80	25	40
*				

New points can also be inserted between existing points by long pressing or right clicking and selecting “Insert Point” from the context menu. ControLog will insert a new point at the selected location and will automatically predict the values.

2900 Data		Auto Profile		
Control Mode: %RH				
Point	Generator Mode	%RH	Temperature [°C]	Mass Flow Ra
1	Generate	20	25	40
2	Generate	50	25	40
3	Generate	80	25	40
*				

-  New
-  Save
-  Close
-  Insert Point
-  Delete Point
-  Run Auto Profile

Existing points can also be deleted by selecting the desired point and then by long pressing or right clicking and selecting “Delete Point” from the context menu.

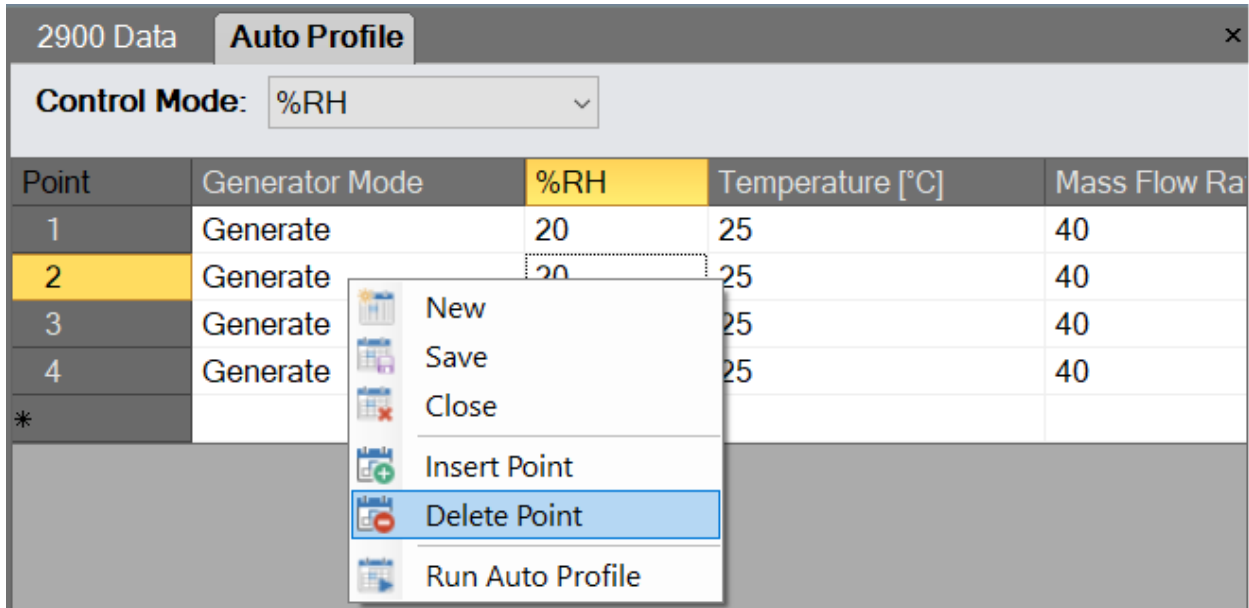

Profile points that cause operational issues for the 2900 are automatically flagged by ControLog and are indicated by a red circle with an explanation point .

CAUTION!

THE USER SHOULD ADDRESS AND RESOLVE ALL ISSUES BEFORE ATTEMPTING TO RUN THE AUTO PROFILE.

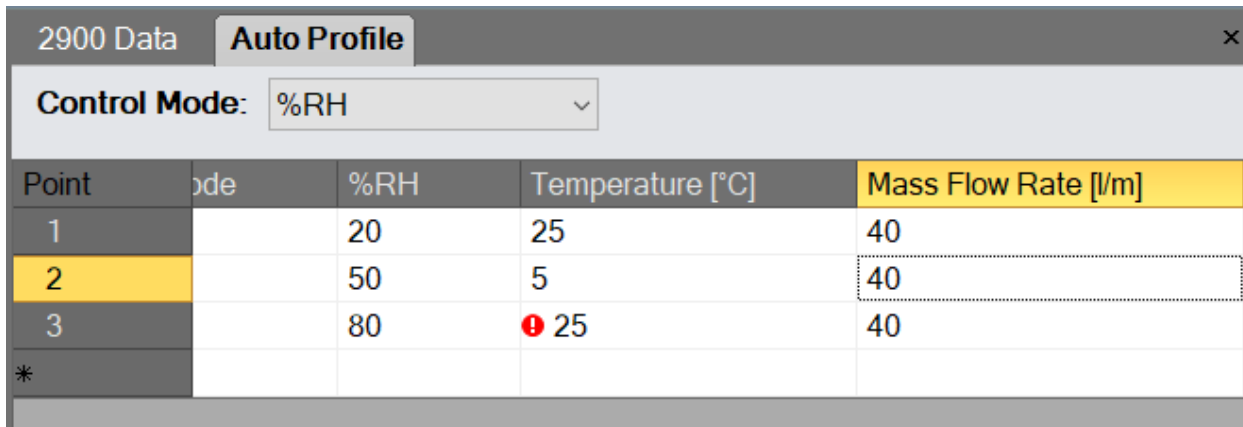

An explanation of the issue will also be displayed.

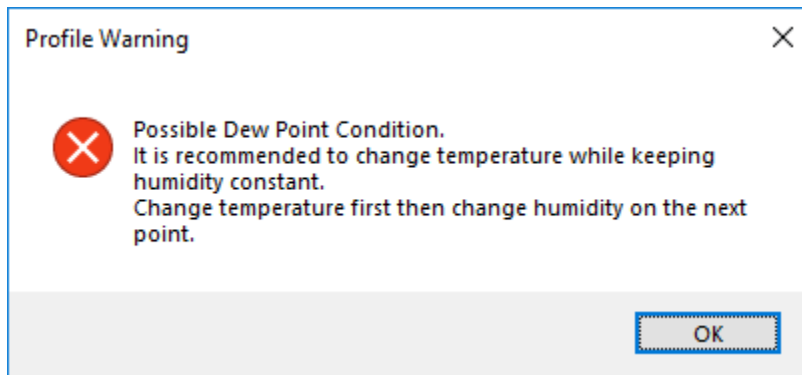

9.2 SAVING A PROFILE

The Profile tab can be saved to file for future recall. ControLog Auto Profiles are saved in XML format with a *.profile extension.

To perform the save, select “Save” from the main menu or right click a profile tab and select “Save”.

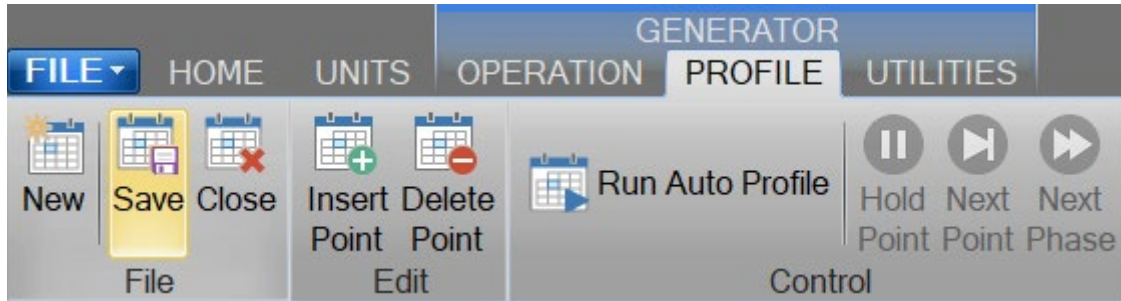

Or

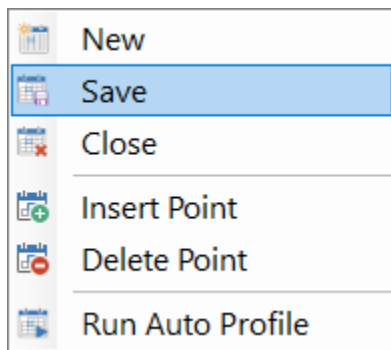

Using the “Save Profile” dialog, select the location and name you want to save the profile as.

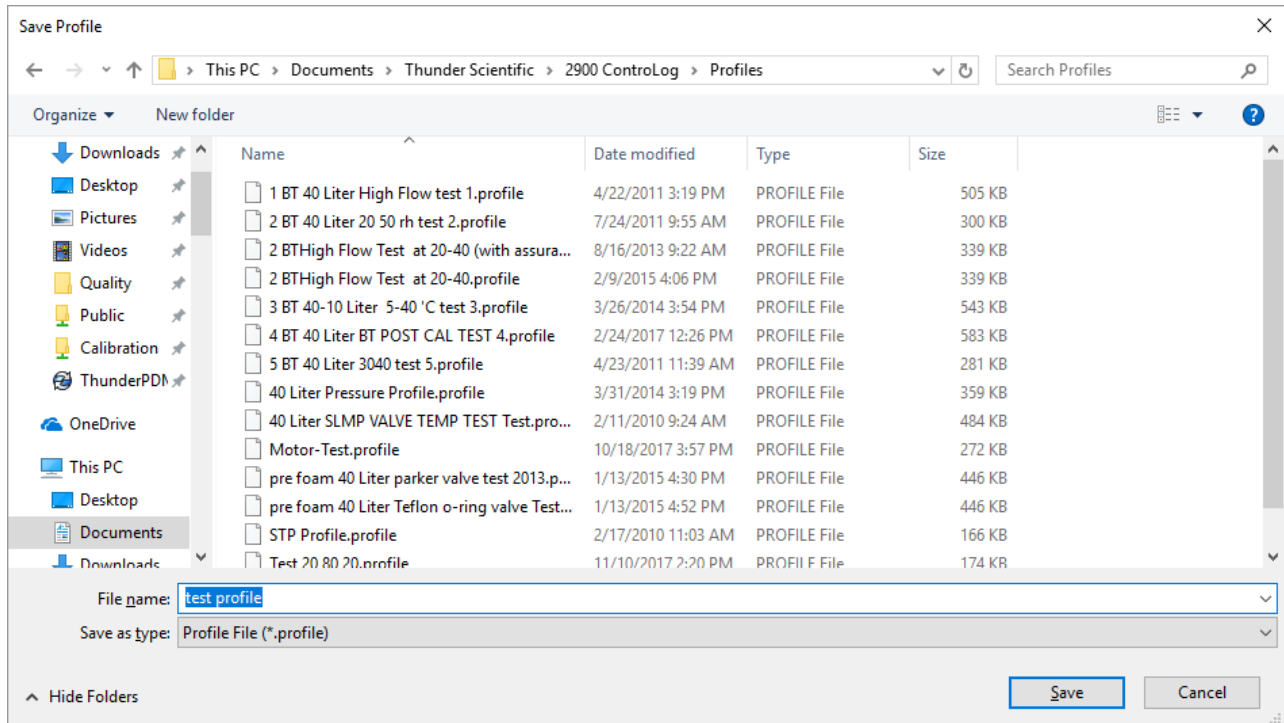

9.3 OPENING A PROFILE

Profiles can be loaded from previously saved profile files.

To perform the open, select “Open” from the file menu and select Profile.

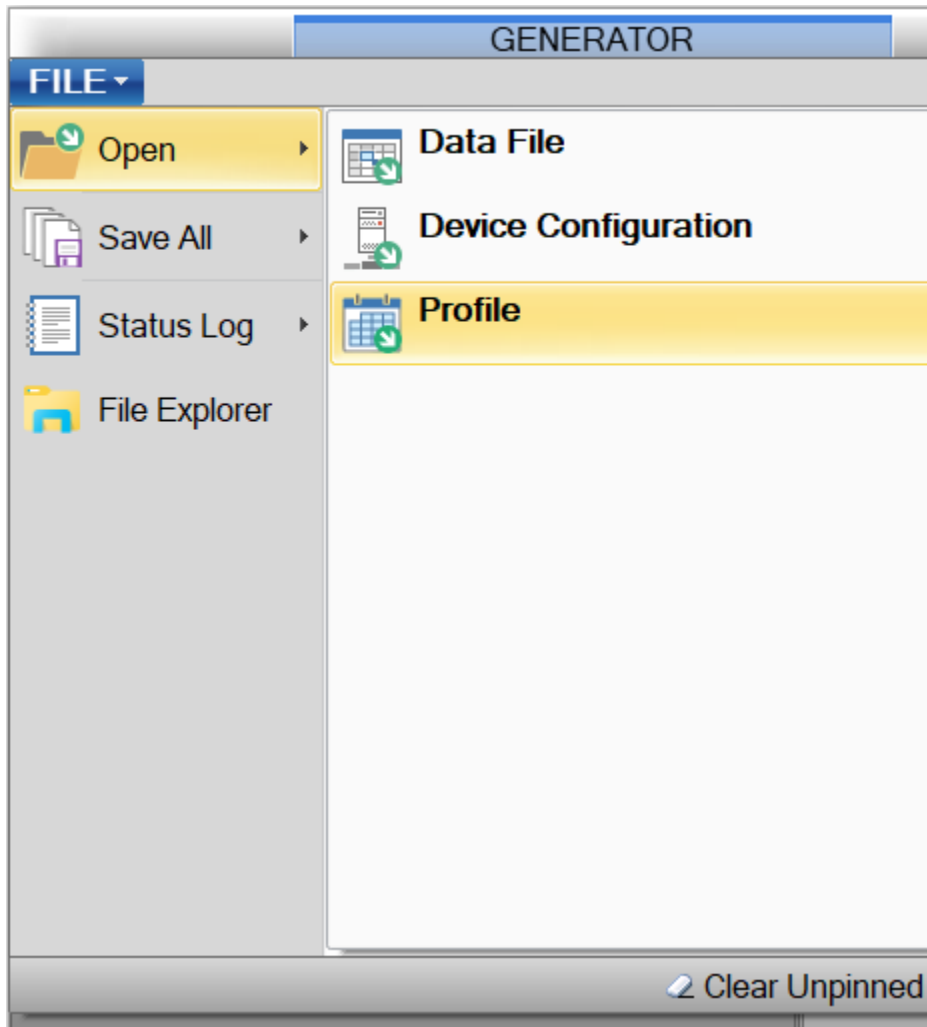

Using the “Open Profile” dialog, browse and select the profile file that you want to open.

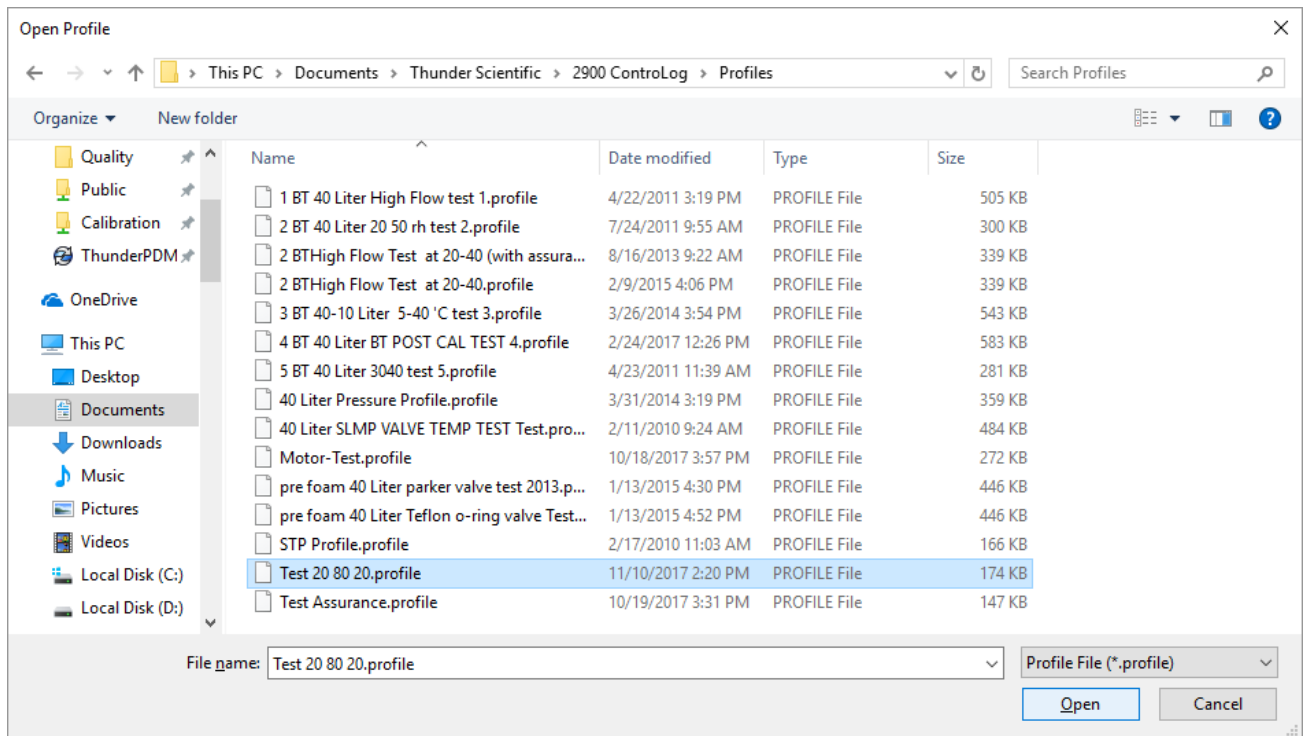

Once the load is complete, the profile tab will be displayed with the loaded profile points.

9.4 RUNNING AN AUTO PROFILE

To run an auto profile, select “Run Auto Profile” from the main menu or right click a profile tab and select “Run Auto Profile”.

Note - While operating the system in the Auto Profile mode, manual setpoint and mode changes are not allowed.

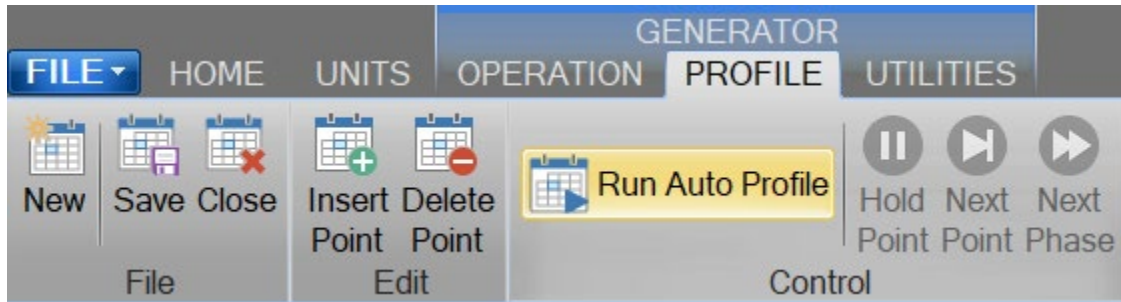

Or

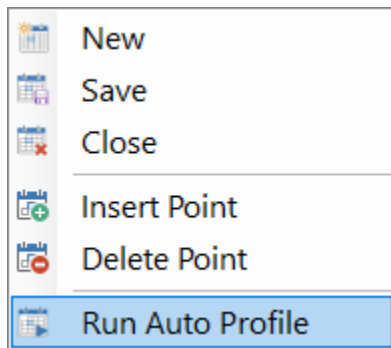

Selection will open the “Profile Starting Point” dialog which allows the user to select which point in the profile they would like to start the profile on. This feature provides more flexibility by allowing the user to skip ahead to a desired point within the auto profile.

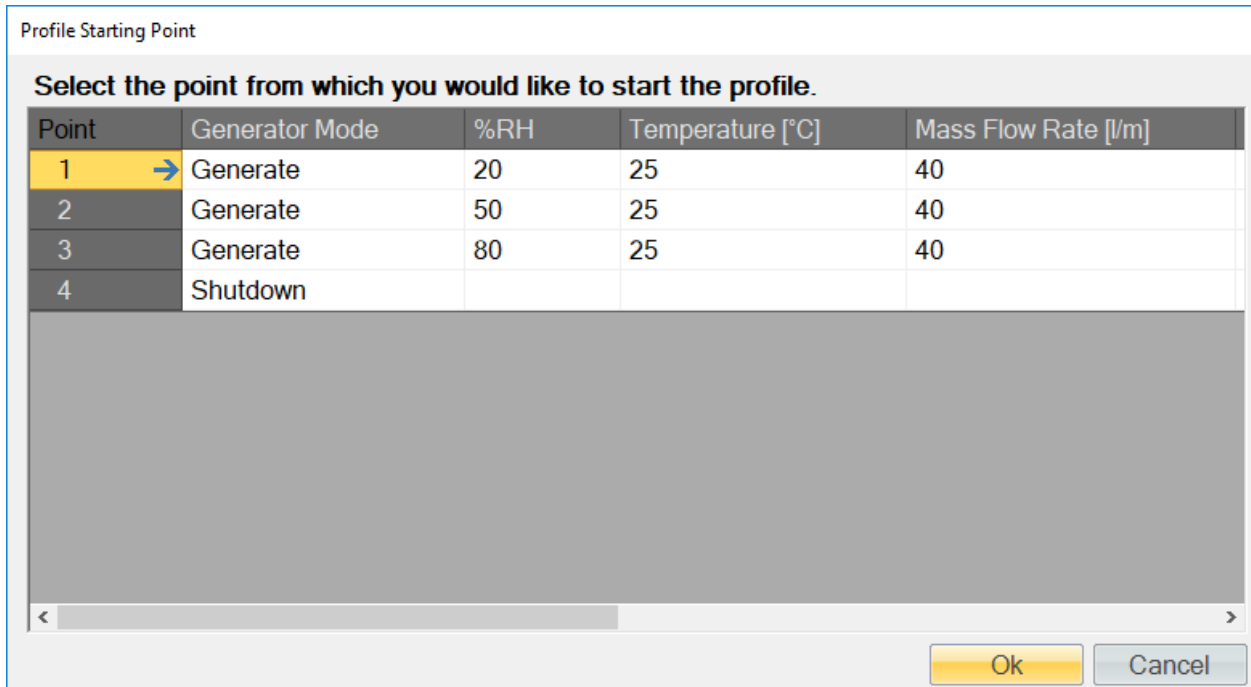

If the profile contained errors, which were indicated by a red circle with an explanation point  on the profile, a warning message will appear when the user tries to run the profile.

CAUTION!

RUNNING A PROFILE WITH ERRORS MAY CAUSE ADVERSE BEHAVIOR DURING THE PROFILE RUN. THE USER IS STRONGLY ENCOURAGED TO ADDRESS AND FIX ALL PROFILE ISSUES BEFORE ATTEMPTING TO RUN THE PROFILE.

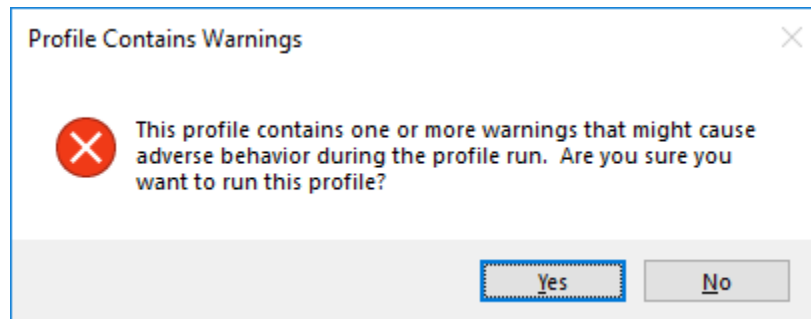

Once the auto profile begins, ControLog will begin sending the commands and setpoints for the starting profile point. The System Timing tab will be displayed in the information tab group and the Auto Profile Controls and Status will appear in the status bar.

The System Timing tab gives detailed information on the Auto Profile as it runs. The elapsed and remaining Phase, Point and Total time are listed along with the detailed assurance conditions values and tolerances.

System Timing								
Auto Profile: Generate - Point: 1 of 4 - Phase: Assurance								
	Elapsed (dd:hh:mm:ss)	Remaining (dd:hh:mm:ss)	Assurance Condition	Actual Value	Min Value	Max Value	Std Dev	Std Dev Limit
Phase Time:	00:00:11:03	00:00:00:00	Saturation Temperature (2900)	30.340	19.900	20.100	1.6182	0.1000
Point Time:	00:00:11:03	00:01:00:00						
Total Time:	00:00:11:03	00:03:00:00						

The Auto Profile Controls and Status consist of the generator run state for the current profile point, the profile point the system is currently running and the phase of the current point. It also consists of three shortcut buttons to control the operation of the auto profile. There is a “Pause Profile” button, advance to “Next Point” button and advance to the “Next Phase” button. These are the same commands that are available in the profile menus.

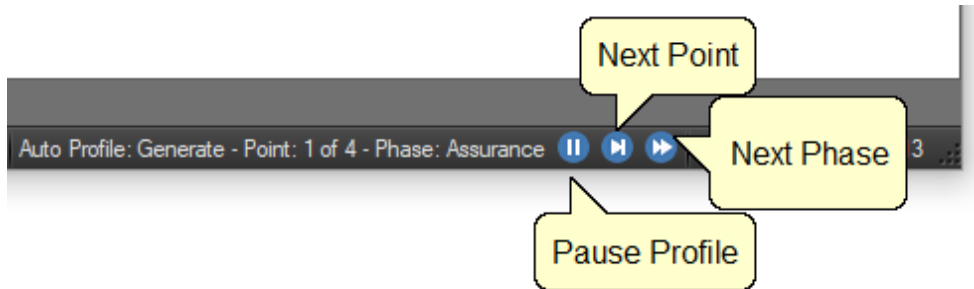

9.4.1 Understanding Profile Phases

Each profile point consists of three distinct phases; Ramp, Assurance and Soak. Each phase accomplishes a specified task.

9.4.1.1 Ramp Phase

The Ramp Phase is used to linearly transition from one point to the next point in a given amount of time.

9.4.1.2 Assurance Phase

The Assurance Phase forces the system to wait until measured parameters and setpoint values are within a specified tolerance and/or stability before the computer starts the Soak Phase.

During the assurance phase, assurance conditions that have not been met will be displayed with a yellow footer block for Setpoint Tile and a yellow header block for Value Tile on the parameter tab of the device containing the condition.

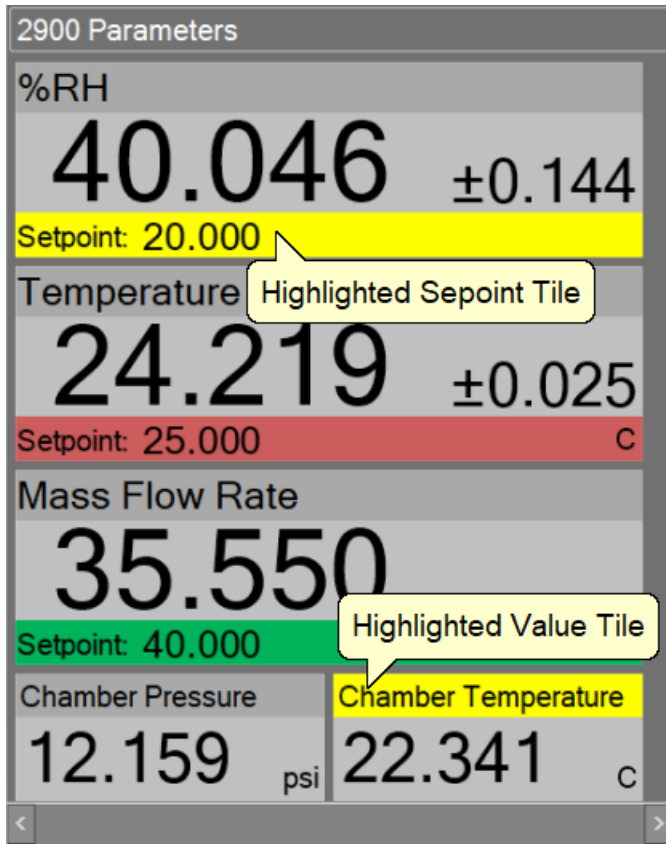

The system timing tab provides a detailed view of each assurance condition for the current point. The actual value of each condition will be displayed in red if it has yet to be met and will be displayed in green once the condition has been met. The system timing tab also displays criteria the condition needs to meet for both tolerance and standard deviation.

System Timing

Auto Profile: Generate - Point: 1 of 4 - Phase: Assurance

	Elapsed (dd:hh:mm:ss)	Remaining (dd:hh:mm:ss)	Assurance Condition	Actual Value	Min Value	Max Value	Std Dev	Std Dev Limit
Phase Time:	00:00:00:27	00:00:00:00	Saturation Temperature (2900)	22.847	19.900	20.100	0.1825	0.1000
Point Time:	00:00:00:27	00:01:00:00	Dew Point (2900)	17.681	-1.8534	-1.6534	0.0300	0.1000
Total Time:	00:00:00:27	00:03:00:00						

Assurance Condition Status

Note - The assurance phase will be active for a minimum of 30 seconds. This delay allows the 2900 to calculate setpoints before ControLog begins to assure each condition.

9.4.1.3 Soak Phase

The Soak phase is the desired amount of time to generate at a particular point before proceeding to the next point.

9.4.1.4 Example 1

Point	Generator Mode	%RH	Temperature [°C]	Mass Flow Rate [l/m]	Ramp Time	Soak Time	Assurance
1	Generate	20	25	50	0 hours	1 hours	No

Example 1 causes the Soak phase to begin immediately at the start of the profile point, even though the 2900 may still be adjusting to the point. The next point will start after the 1-hour soak phase.

9.4.1.5 Example 2

Point	Generator Mode	%RH	Temperature [°C]	Mass Flow Rate [l/m]	Ramp Time	Soak Time	Assurance
1	Generate	20	25	50	0 hours	1 hours	Yes

Example 2 causes the Assurance phase to begin immediately at the start of the profile point. Measured values are continually compared with the setpoint values until they agree with the set tolerance and/or the measured values are stable to within the specified degree. Once assured (tolerances met) the Soak phase begins. Total time required for this point varies and depends upon the amount of time that is required for assurance (dictated by tolerances). Total time for example 2 is elapsed assurance time plus 1 hour.

9.4.1.6 Example 3

Point	Generator Mode	%RH	Temperature [°C]	Mass Flow Rate [l/m]	Ramp Time	Soak Time	Assurance
2	Generate	30	25	50	15 minutes	1 hours	Yes

The Ramp phase (Ramp Timer) begins at the start of the point. The system adjusts slowly toward the setpoint, taking 15 minutes. Once the ramp time has elapsed, assurance starts and waits for tolerances to be met. When tolerances are met, the soak phase begins and lasts 1 hour. Total time for example 3 is 15 minutes, plus elapsed assurance time, plus 1 hour. Assurance time is a variable and depends on tolerances.

9.4.2 Manual Override of Profile

Although the system is operating automatically, some manual control is allowed using the Hold Point, Next Phase and Next Point menu items on the Run menu or Status Bar.

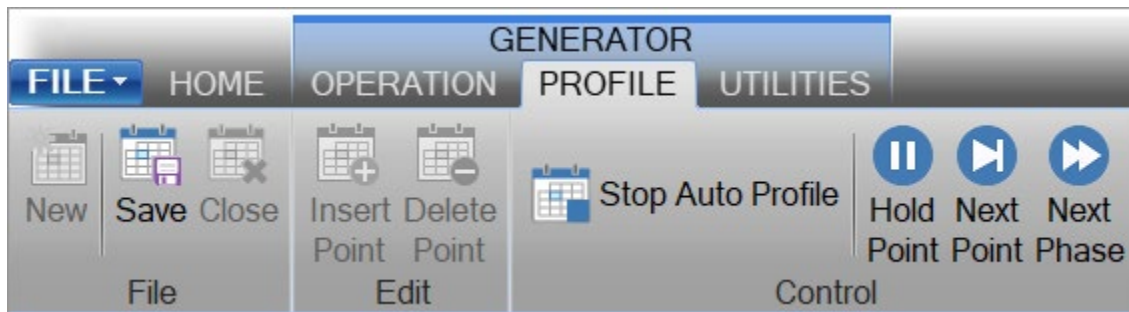

Or

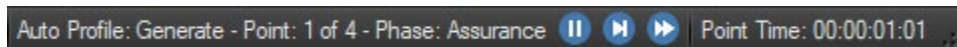

9.4.2.1 Holding the Profile

Selecting Hold Point from the profile menu or status bar will stop the current "Remaining Time" timers, allowing the system to remain indefinitely at the current point. While in a hold mode, the system is prevented from completing the ramp, assurance, or soak phases of a point.



When holding, a hold indicator appears in the System Timing tab and the hold menu buttons change into resume buttons.

System Timing							
Auto Profile: Generate - Point: 1 of 4 - Phase: Assurance (On Hold)							
	<u>Elapsed</u> <u>(dd:hh:mm:ss)</u>	<u>Remaining</u> <u>(dd:hh:mm:ss)</u>	<u>Assurance Condition</u>	<u>Actual Value</u>	<u>Min Value</u>	<u>Max Value</u>	<u>Std Dev</u> <u>Std Dev Limit</u>
Phase Time:	00:00:03:53	00:00:00:00	%RH (2900)	73.391	19.000	21.000	
Point Time:	00:00:03:53	00:01:00:00					
Total Time:	00:00:03:53	00:03:15:00					

Status Log **System Timing**

To resume the profile point, select the Resume Point from the profile menu or status bar. This re-enables the timing functions and allows the profile to resume normal operation.

9.4.2.2 Advancing to the Next Point

Selecting Next Point from the Run menu or status bar manually duplicates the action which automatically occurs when the Point time counter reaches zero.



9.4.2.3 Advancing to the Next Phase

Selecting Next Phase from the profile menu or status bar manually duplicates the action which automatically occurs when a Remaining Ramp or Soak Time counter reaches zero, or when the assurance conditions are met. In other words, it causes Ramp Phase to proceed to the Assurance or Soak Phase, Assurance to proceed to Soak, or Soak to proceed to Ramp of the next profile point. This allows for early manual termination of any phase within a profile point.



9.4.2.4 Stopping the Auto Profile

Selecting Stop Auto Profile from the profile menu or context menu will terminate the profile at the current point and the generator will continue at its current setpoints for Saturation Pressure, Saturation Temperature and Flow. Another way to exit the Auto Profile is to switch from Auto Profile to Generate or Shutdown.

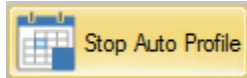

10 CONNECTIONS

ControLog supports a customizable interface that works with most devices. ControLog will allow the user to create a new device connection using the “Connection Wizard” or open previously saved connections. The wizard will open a separate dialog window containing various steps that will guide the user in defining the communication required to receive the desired data items from the device. The user can create as many (up to 60) or as few data items as they see fit for any one device. Each data item can be uniquely named and once connected will be recorded in its own parameter and data tab. ControLog also allows the user to save these interfaces for future use.

Note - *ControLog has a limit of eight devices connected at any given time.*

The “Connection Wizard” allows the user to step through the connection configuration. Using the “Next” and “Back” buttons, the user can progress through the connection configuration steps. At any time, the user may cancel the new connection or opening of a connection by selecting the “Cancel” button. Once the last step has been completed, the “Finish” button will be available to complete the new connection.

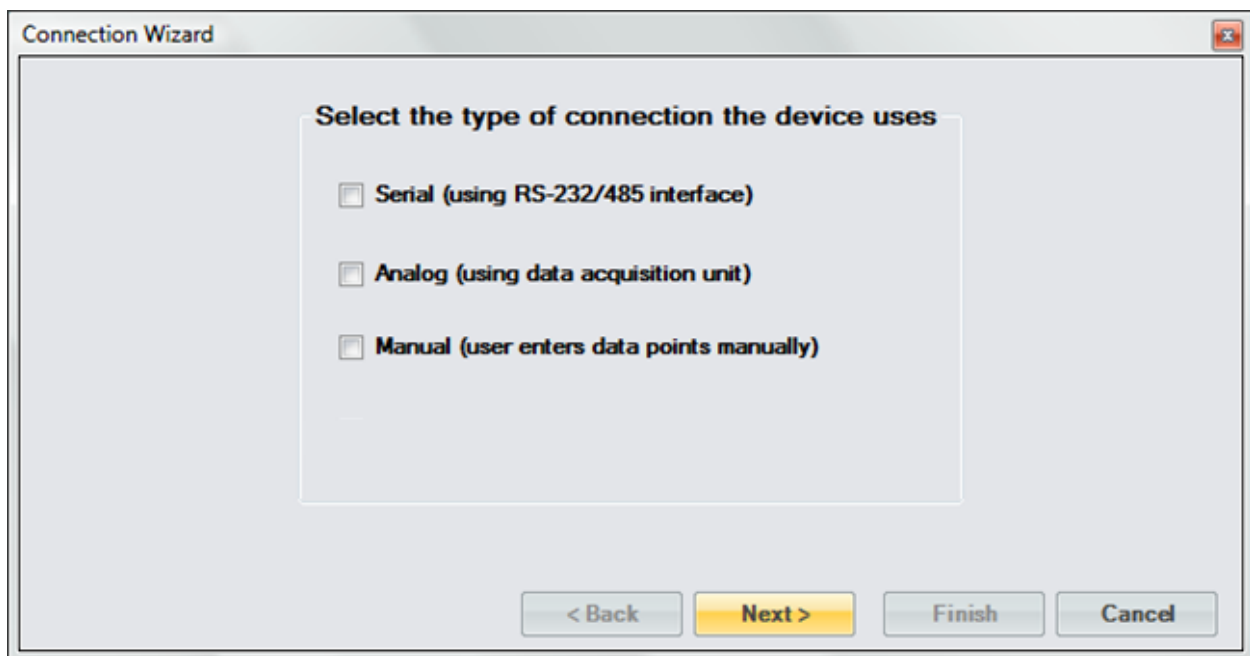

Note - *It is always recommended to have the manufacturer’s documentation for the device being connected while creating the new connection. It is also recommended to use a terminal-based application to test the various commands before creating a new connection.*

10.1 SERIAL CONNECTION

A Serial Connection uses either an RS-232 or RS-485 interface to acquire data from a given ASCII based serial device. The customizable interface provided by ControLog allows the user to define the ASCII commands that are sent and/or received through the RS-232/485 interface to communicate with the serial device. The system supports both request to receive type of communication as well as receive only type of communication.

To create a new serial connection, select “New Device” from the Home menu tab. This will open a “Connection Wizard” dialog that will step the user through the connection definition process.

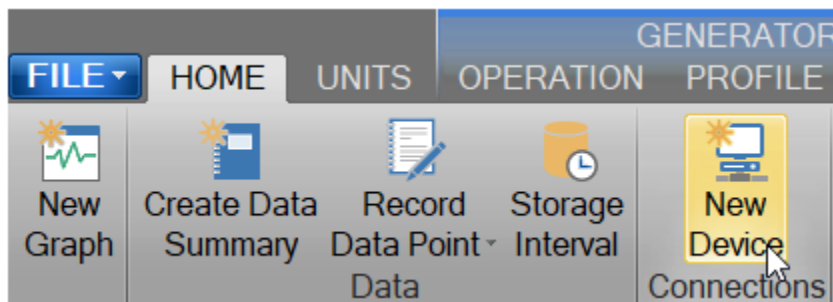

Select “Serial” as the type of connection the device uses.

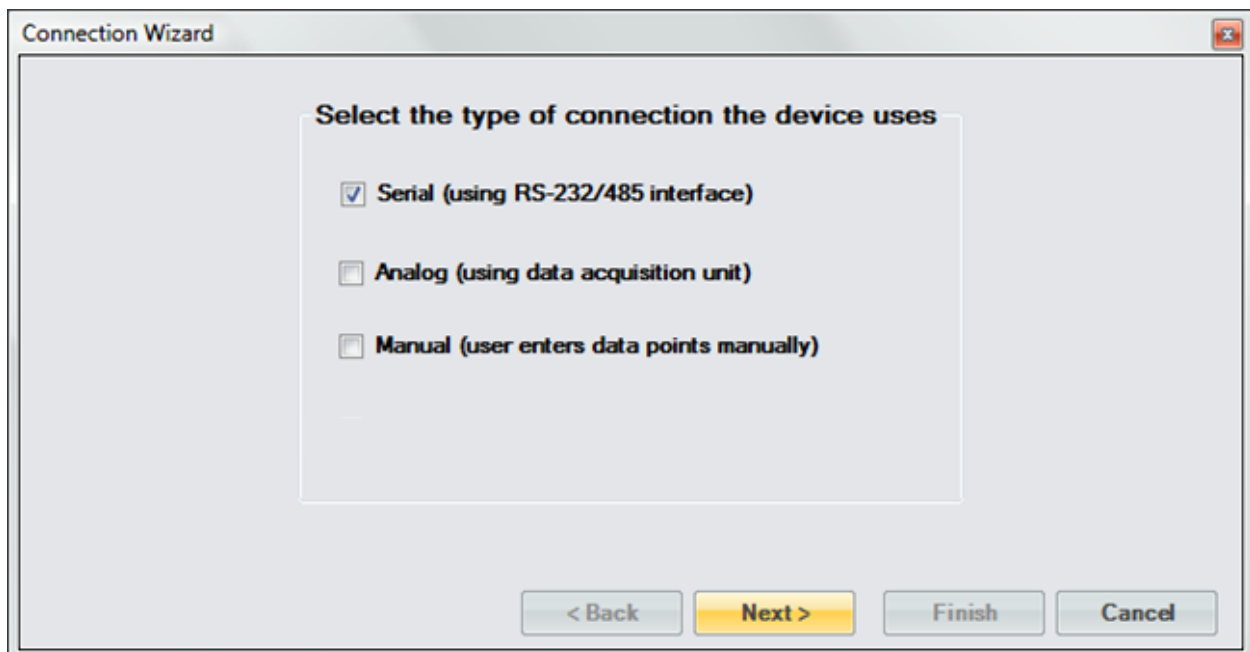

Enter a unique name for the device.



The screenshot shows a window titled "Connection Wizard" with a close button in the top right corner. The main area contains the text "Enter a name for the device" above a single-line text input field. At the bottom, there are four buttons: "< Back", "Next >" (highlighted in yellow), "Finish", and "Cancel".

Select whether the device requires a setup command or commands. Setup commands are only sent once at the start of communication. These commands are only required if you need to send special commands to configure the device before data request and response commands are processed.



The screenshot shows a window titled "Connection Wizard" with a close button in the top right corner. The main area contains the question "Do you need to send a setup command or commands to configure this device?" followed by two radio button options: "Yes" (unchecked) and "No" (checked). Below the options is explanatory text: "Select 'Yes' if you need to send a setup command or commands to configure the device. Setup commands are only sent once at the start of communication. These commands are only required if you need to send special commands to configure the device before data request and response commands are processed." and "Select 'No' if you don't need to send any setup commands." At the bottom, there are four buttons: "< Back", "Next >" (highlighted in yellow), "Finish", and "Cancel".

If setup commands are required, then enter the ASCII setup command or commands that will be sent at the start of communication. Refer to the legend to enter special characters such as carriage returns and/or line feeds.

Note - All commands are case sensitive.

Note - End of Line (EOL) or End of Transmission (EOT) characters such as carriage returns and/or line feeds are very important and are the leading cause of failed communication. Refer to the manufacturer's documentation for the device to verify the required EOL or EOT characters.

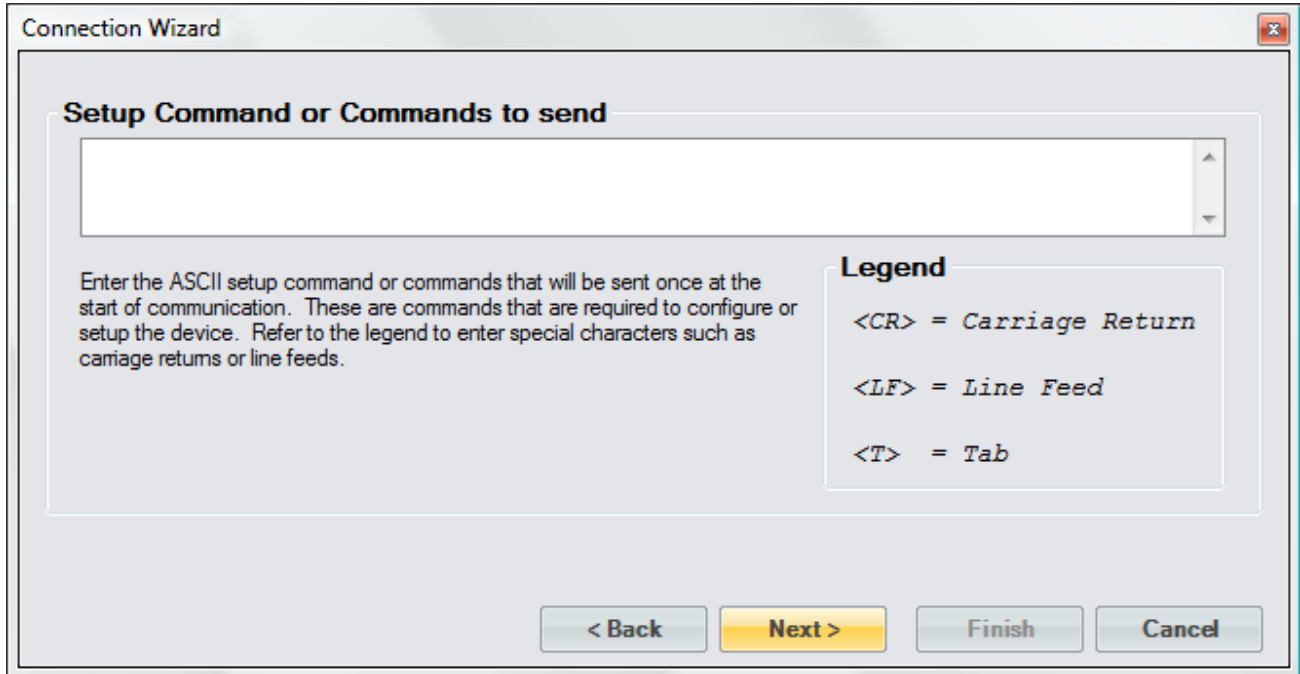

Enter the number of responses you expect to receive from the device. This is the amount of response messages that you will receive from the device, not necessarily the number of data items. A device response message could contain multiple data items. Later you will select the number of data items that each response message contains.

For example, if you need to send three commands to receive three response messages, then you would enter three. Or, if your device automatically sends one message periodically you would only have a single response and you would enter one.

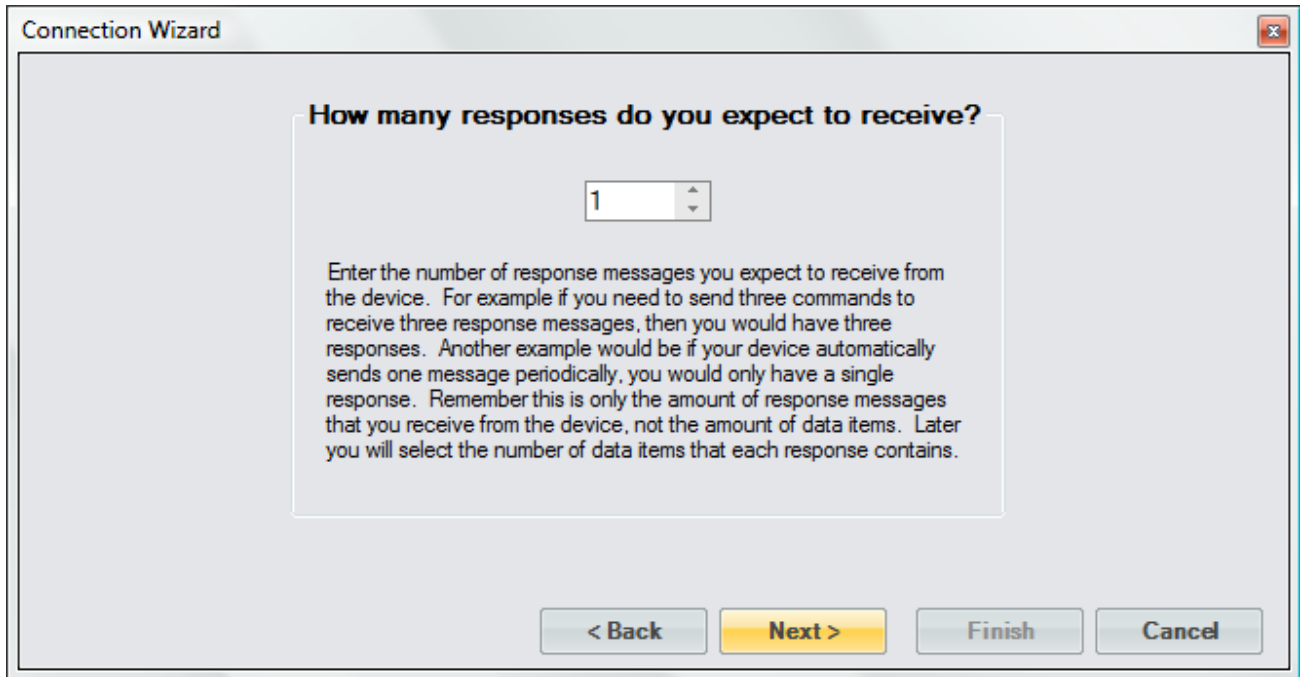

Select whether a command needs to be sent to request a response. If the device requires a command to be sent to receive a response, then select "Yes". If the device automatically outputs data without any request, then select "No".

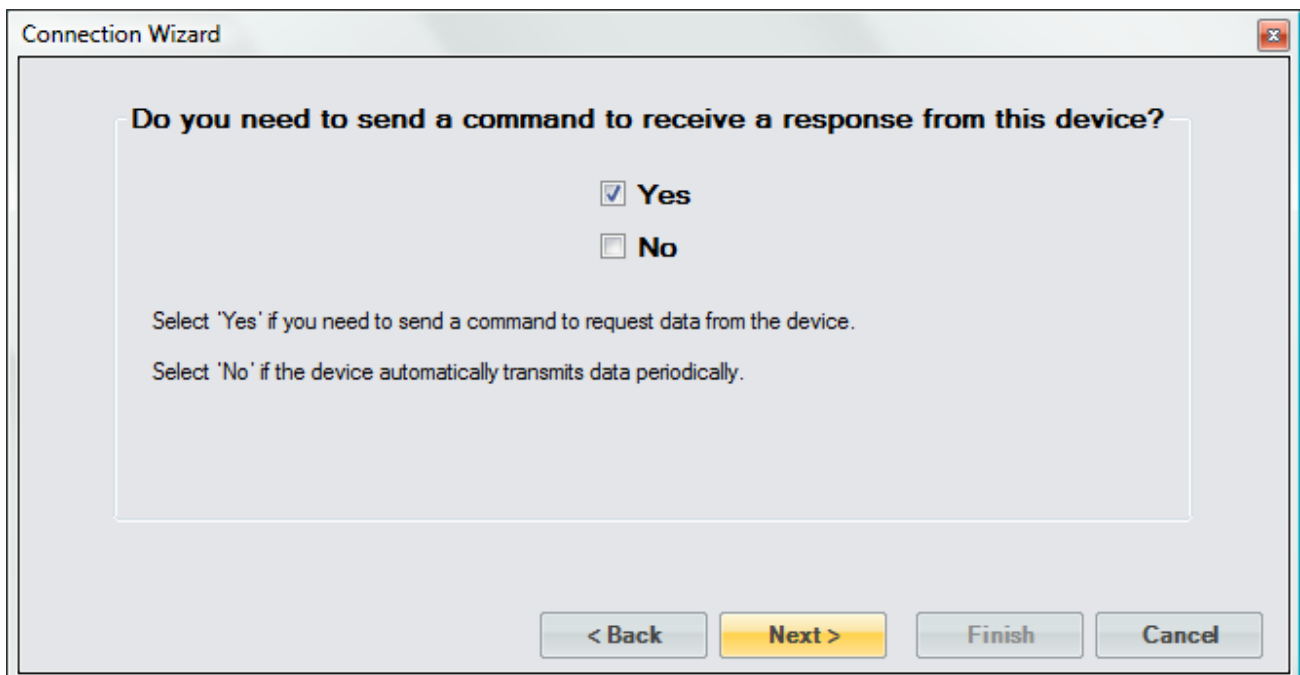

If a command was required, then enter the ASCII Command or Commands to request the desired data from the device. Refer to the legend to enter special characters such as carriage returns and/or line feeds.

Note - All commands are case sensitive.

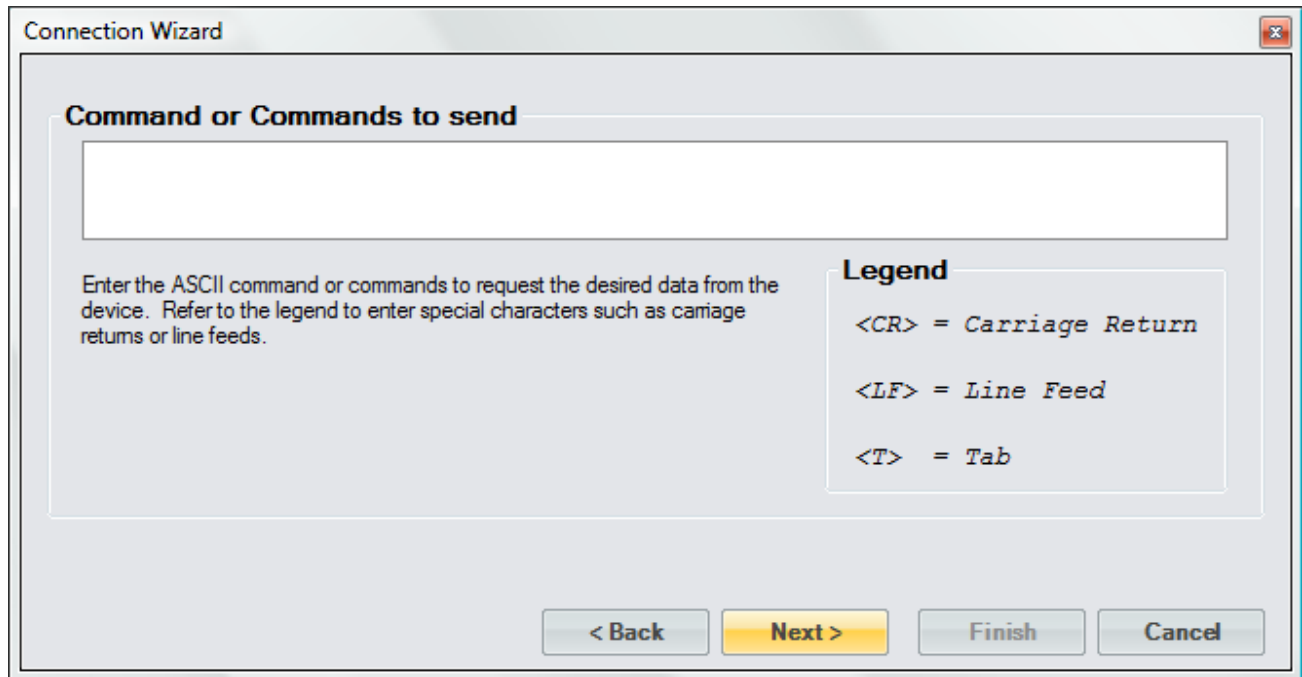

The screenshot shows a window titled "Connection Wizard" with a close button in the top right corner. The main area is titled "Command or Commands to send" and contains a large empty text box. Below the text box is the instruction: "Enter the ASCII command or commands to request the desired data from the device. Refer to the legend to enter special characters such as carriage returns or line feeds." To the right of this instruction is a "Legend" box containing the following entries: "<CR> = Carriage Return", "<LF> = Line Feed", and "<T> = Tab". At the bottom of the window are four buttons: "< Back", "Next >" (highlighted in yellow), "Finish", and "Cancel".

Select the ASCII identification that will be used to identify the response if no command is required but the device automatically sends messages periodically. The identification is the unique characters at the beginning of the message that identifies the response received. This is often used on devices that automatically transmit multiple data messages without the use of a command to request data.

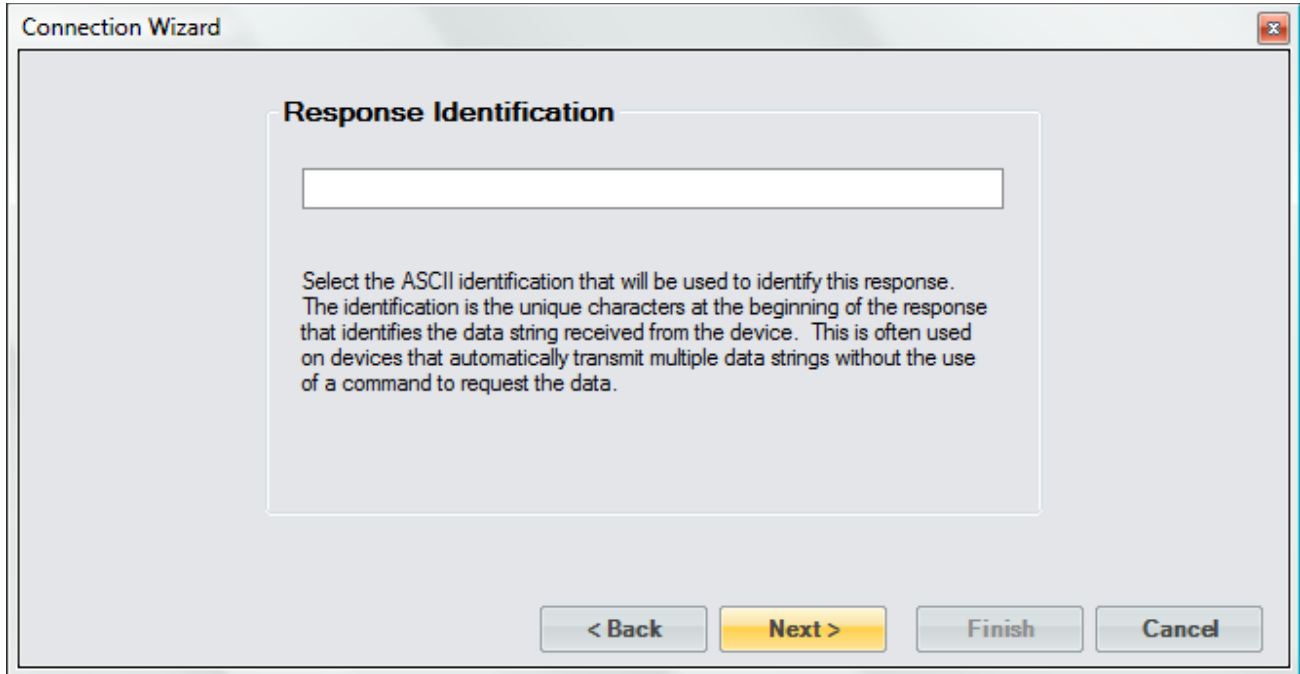

Select whether the response has a delimiter that is separating each data item. For example, if the response contains Dew Point, Frost Point and Pressure with a comma between each data item then each item is separated by a comma delimiter.

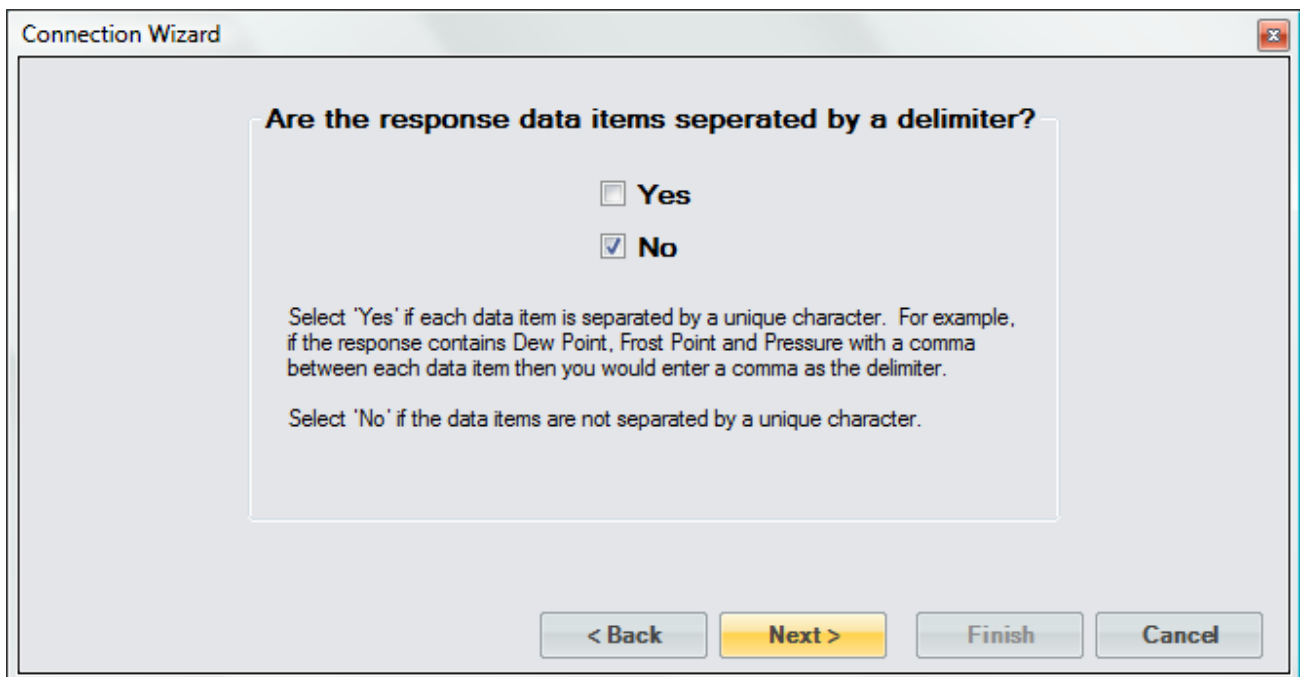

Enter the number of data items the response message contains. A data item is the numeric value or flag portion for a single device parameter within the response message. For example, if the response contains Dew Point, Frost Point and Pressure then you would have three data items. If the response only contains a single numeric value or flag, then you would only have one data item for this response.

Connection Wizard

How many data items does the response contain?

1

Enter the number of data items this response message contains. A data item is the numeric value or flag for a single device parameter. For example, if the response contains Dew Point, Frost Point and Pressure then you would have three data items. If the response only contains a single numeric value or flag then you would only have one data item for this response.

< Back Next > Finish Cancel

Enter a name or description for the data item and define the syntax, unit and scaling. The data item syntax is defined using the symbols in the Legend. Use the “X” symbol to indicate a character that should be ignored, use the “N” symbol to represent a numeric ASCII character and the “A” symbol to indicate a flag or any ASCII character. This dialog will repeat for each data item in the response.

Note - *The syntax cannot contain both a Flag and a Numeric syntax definition. If the user requires both, then create another data item to define them separately.*

Connection Wizard

Data Item Name **Data Item Syntax** **Data Item Unit**

Enter a name or description of the data item and define the syntax for the response using the coded symbols defined in the legend. Note that the syntax cannot contain both a Flag and Numeric syntax definition. If you require both, then create another data item to define them separately.

Scaling

Signal Value	Data Value

Legend

X = Ignore
N = Numeric
A = Flag

Response Syntax

< Back Next > Finish Cancel

When defining a numeric syntax enter an “N” for each possible digit in the response. For example, if you know the device returns a six-digit numeric value you would enter “NNN.NNN”. The decimal point is not required, and its location is not important. Decimal points, plus signs and minus signs are treated the same as an “N” and are allowed merely to help make the syntax resemble a number value.

Note - It is important to have sufficient numeric definition to assure all possible numeric responses will be covered, especially when a device responds with scientific notation or varying precession.

Connection Wizard

Data Item Name **Data Item Syntax** **Data Item Unit**

Enter a name or description of the data item and define the syntax for the response using the coded symbols defined in the legend. Note that the syntax cannot contain both a Flag and Numeric syntax definition. If you require both, then create another data item to define them separately.

Scaling

Signal Value	Data Value

Legend

X = Ignore
N = Numeric
A = Flag

Response Syntax

NNN.NNNN

< Back Next > Finish Cancel

It is possible to scale a numeric data item response. The scaling consists of a two-point definition for a linear scaling or a three to five-point definition for polynomial fit scaling. The number of points determines the degree of the polynomial used to scale the data item response. A Singular Value Decomposition (SVD) algorithm is used to determine the coefficients of the polynomial. Each point definition consists of a signal value and a data value. The signal value represents the “raw” output signal from the device. The data value represents the actual value or real-world value at the given signal value.

Scaling allows the user to scale a numeric data item response into a given humidity value. For example, if you have a numeric data item response that ranges from -1 to 1 and it is known that 0 corresponds to -100 and 1 corresponds to 100. The user can then enter these scaling values and ControLog will automatically apply the scaling to the data item whenever it is displayed or logged.

The screenshot shows the 'Connection Wizard' dialog box with the following fields and sections:

- Data Item Name:** Data Point
- Data Item Syntax:** NNN.NNNN
- Data Item Unit:** None
- Legend:**
 - X = Ignore
 - N = Numeric
 - A = Flag
- Scaling Table:**

Signal Value	Data Value
-1	-100
1	100
- Response Syntax:** NNN.NNNN
- Navigation Buttons:** < Back, Next >, Finish, Cancel

Selecting the unit for the data item will allow ControLog to convert the value to the selected system units for display in the parameter tab and record the value in the default SI units in the data tab. Remember this is the unit the device is sending the data item in, not the unit you wish to display the data item as. If “None” is selected, then ControLog will treat the data item as a simple number and will display and record the value exactly as it is received.

Connection Wizard

Data Item Name
Data Point

Data Item Syntax
NNN.NNNN

Data Item Unit
Temperature °C

Temperature
°F
°C
K

X = Ignore
N = Numeric
A = Flag

Enter a name or description of the data item and define the syntax for the response using the coded symbols defined in the legend. Note that the syntax cannot contain both a Flag and Numeric syntax definition. If you require both, then create another data item to define them separately.

Scaling

Signal Value	Data
-1	-1
1	100

Response Syntax
NNN.NNNN

< Back Next > Finish Cancel

In addition to reading a temperature, ControLog can compute a percent relative humidity (%RH) at the temperature. This is useful when compensating for temperature gradients within the chamber. To have ControLog automatically calculate the relative humidity at the temperature, simply select the corresponding checkbox. The newly calculated %RH will have the same name as the specified Data Item Name but will be preceded by “%RH@”. In the below example the calculated %RH will appear as “%RH@Data Point”.

The screenshot shows the 'Connection Wizard' dialog box with the following configuration:

- Data Item Name:** Data Point
- Data Item Syntax:** NNN.NNNN
- Data Item Unit:** Temperature, °C
- Also Calculate %RH at this Temperature**
- Legend:**
 - X = Ignore
 - N = Numeric
 - A = Flag
- Scaling Table:**

Signal Value	Data Value
-1	-100
1	100
- Response Syntax:** NNN.NNNN

Buttons at the bottom: < Back, Next >, Finish, Cancel.

When defining flag type syntax, enter an “A” for each character in the response that represents the flag. The Flag Definitions define what each possible ASCII flag represents. The user must enter a numeric value for each flag definition which will be recorded in the data tab and a description for the flag that will be shown in the parameters tab.

Connection Wizard

Data Item Name: Stable
Data Item Syntax: XXXA
Data Item Unit: None

Enter a name or description of the data item and define the syntax for the response using the coded symbols defined in the legend. Note that the syntax cannot contain both a Flag and Numeric syntax definition. If you require both, then create another data item to define them separately.

Flag	Numeric Value	Description
*	0	No
S	1	Yes

Legend
X = Ignore
N = Numeric
A = Flag

Response Syntax
 XXXA

< Back Next > Finish Cancel

Enter the End of Transmit (EOT) character that is sent after the response. This is the ASCII character that is sent at the end of transmission of the response. Refer to the legend to enter special characters such as carriage returns and/or line feeds.

Connection Wizard

End of Transmit (EOT) character sent after the response

Select the ASCII character that is sent at the end of transmission of the response. Refer to the legend to enter special characters such as carriage returns or line feeds.

Legend
 <CR> = Carriage Return
 <LF> = Line Feed
 <T> = Tab

< Back Next > Finish Cancel

Select the name and location to save the new serial connection. Selecting the “Browse” button will open a save file dialog that will allow the user to specify the name and browse to the desired location to save the file. All device connection files are saved in XML format with a (*.device) extension.



Next, the user can select whether to connect to the device now or to exit without connecting.

Note - *The user can connect at any time by loading the device from the Connections menu.*



Select the communication port that the device is connected to and select the port settings for the device.

CAUTION!

INCORRECT RTS AND DTR SETTINGS CAN PROHIBIT COMMUNICATION. REFER TO THE DEVICE MANUFACTURER'S DOCUMENTATION TO VERIFY ALL DEVICE PORT SETTINGS.

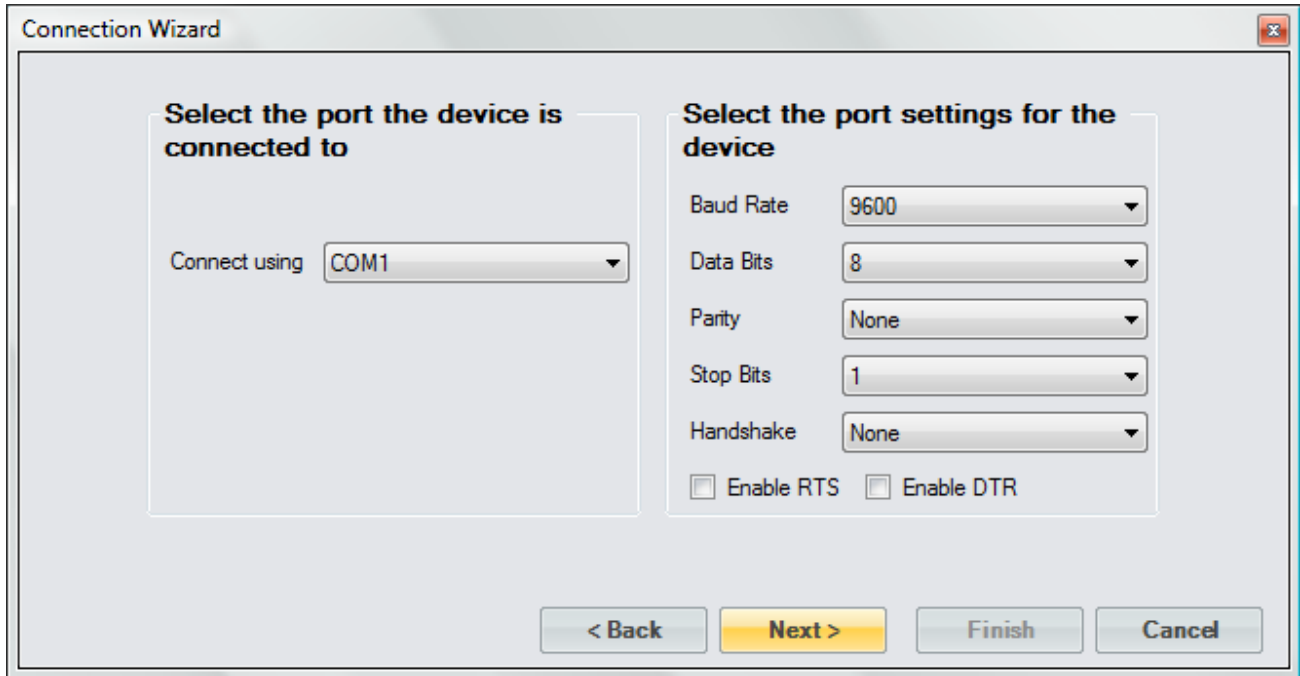

The screenshot shows a 'Connection Wizard' dialog box with two main sections. The left section, titled 'Select the port the device is connected to', contains a 'Connect using' label and a dropdown menu currently set to 'COM1'. The right section, titled 'Select the port settings for the device', contains five dropdown menus: 'Baud Rate' (9600), 'Data Bits' (8), 'Parity' (None), 'Stop Bits' (1), and 'Handshake' (None). Below these are two checkboxes: 'Enable RTS' and 'Enable DTR', both of which are unchecked. At the bottom of the dialog are four buttons: '< Back' (disabled), 'Next >' (highlighted in yellow), 'Finish' (disabled), and 'Cancel' (disabled).

Select the access rate at which ControLog will communicate with the device.

Note - *It is always recommended to start with the default 1.5 second access interval and to modify later as needed.*

CAUTION!

DO NOT SET THE ACCESS INTERVAL TOO SMALL. IF THE DEVICE IS NOT CAPABLE OF COMMUNICATING AT THE SET INTERVAL THEN CONTROLOG MAY INADVERTENTLY THINK COMMUNICATION HAS BEEN LOST WHEN THE DEVICE DOES NOT REPLY WITHIN THE DESIRED ABOUT OF TIME.



Select "Show Interface Console" to automatically open a Device Interface Console tab once communication has been established with the device.

10.1.1 Serial Connection Example 1

This example will demonstrate the creation of a serial connection to an RH Systems® 373 Dew Point Mirror. We will request the Frost Point temperature and Atmospheric Pressure from the mirror as data items.

Start by selecting “New Device” from the Home menu tab.

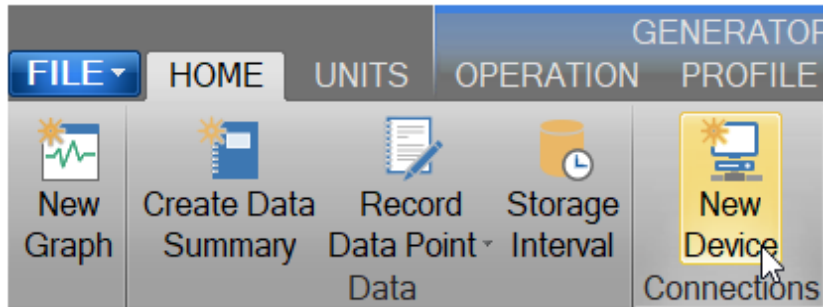

Select “Serial” as the type of device connection.

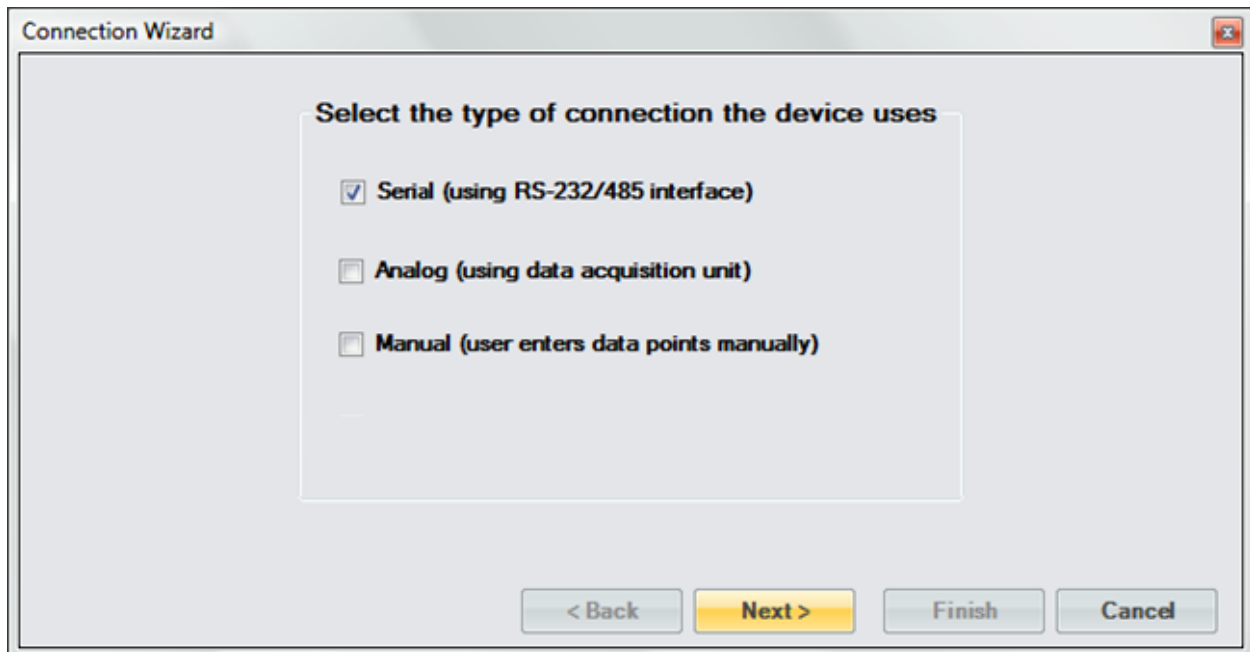

Enter "373 Dew Point Mirror" as the name for the device.



For the 373 we do not need to send any setup commands.



The 373 will send two responses; one with the requested Frost Point value and the other with the requested Atmospheric Pressure value.

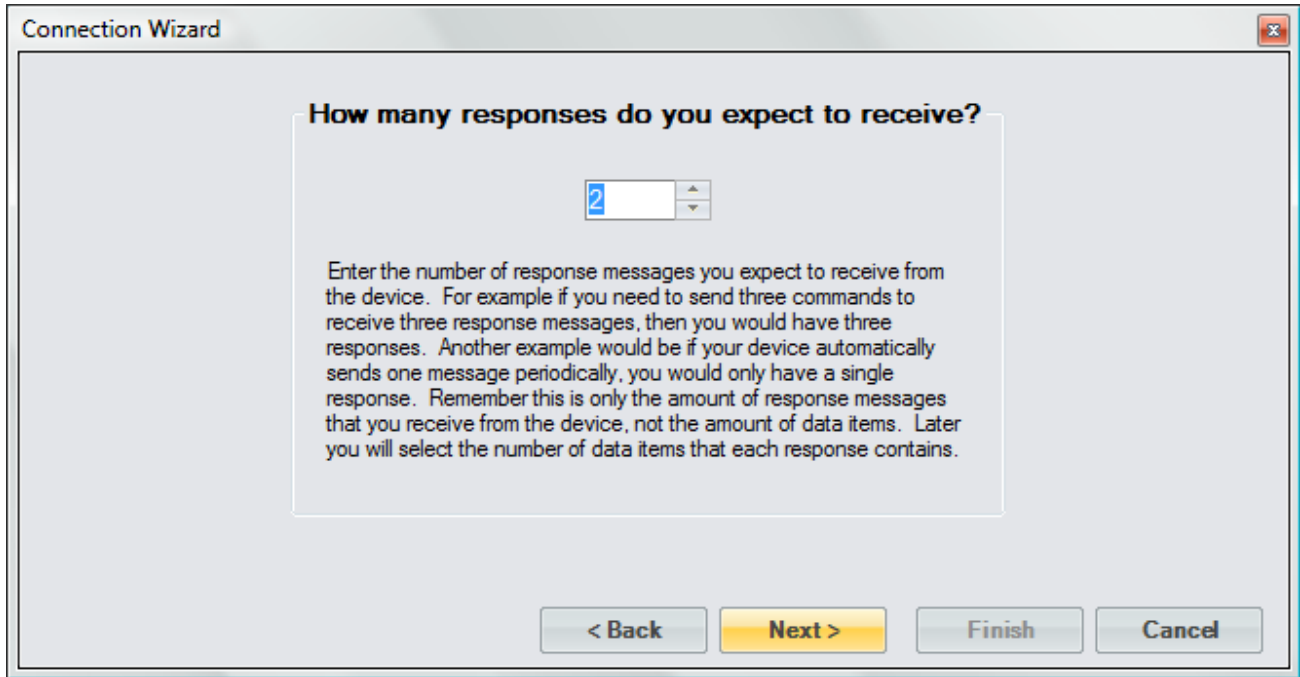

The 373 requires a request command to be sent to receive either the Frost Point value or the Atmospheric Pressure value.

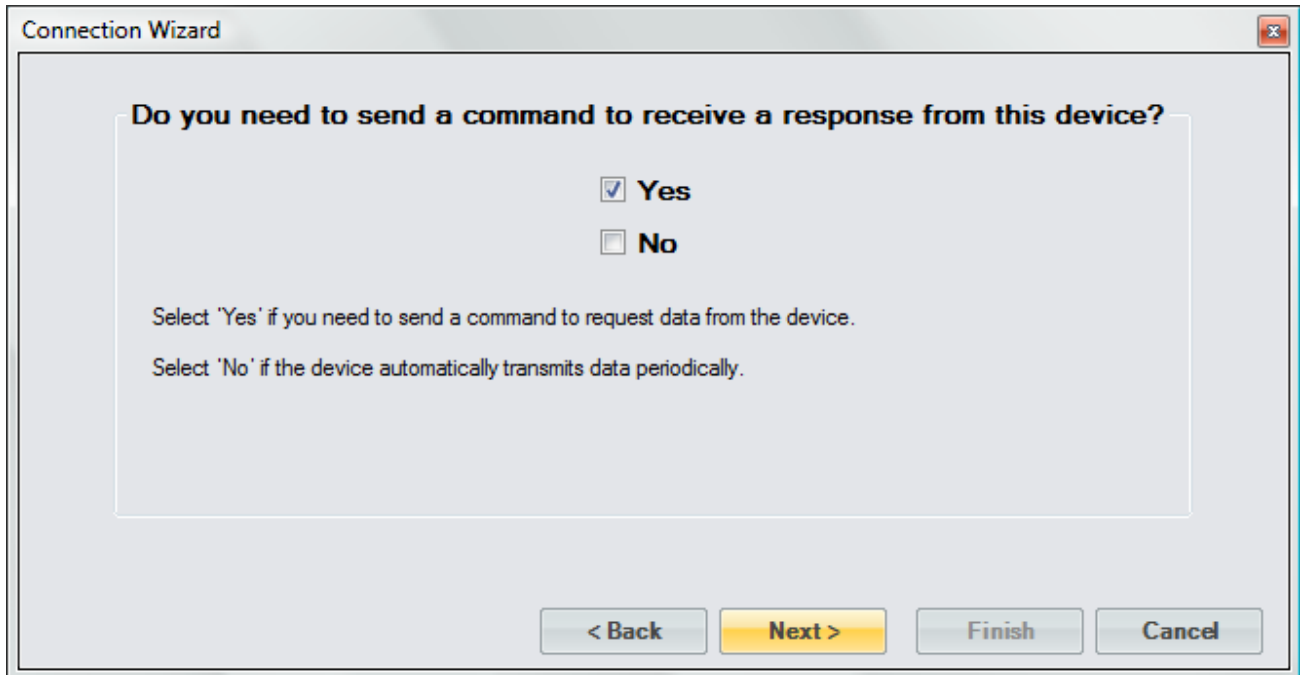

The 373 documentation tells us we need to send the frost point command to receive the Frost Point value. The documentation also states the command must be terminated with a carriage return or a carriage return line feed combination.

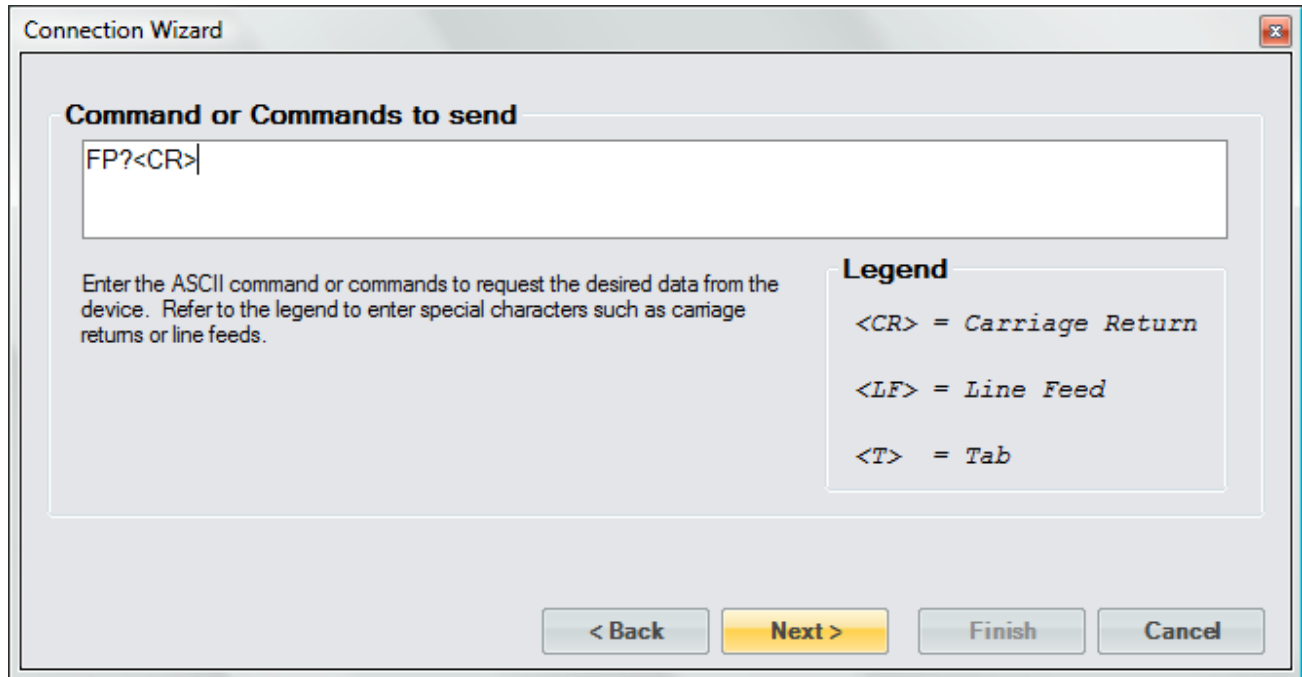

The 373 will respond to the frost point command with a single numeric value and therefore no delimiter is used.

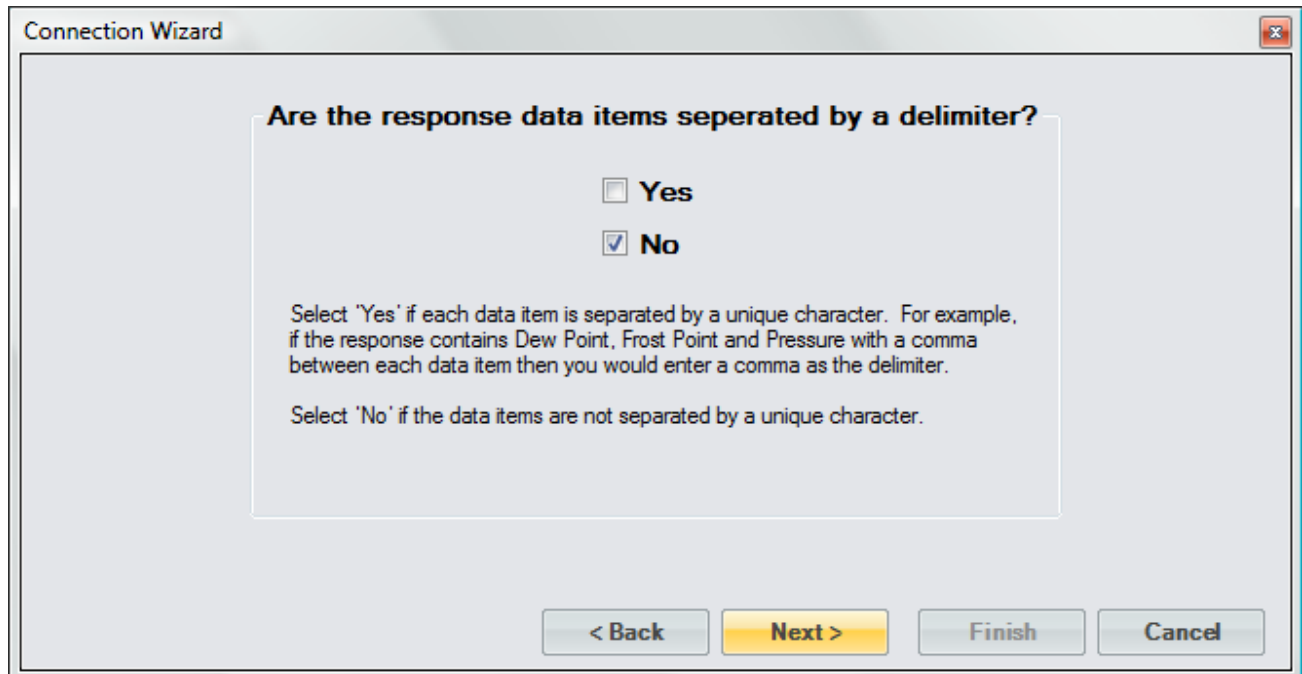

The response from the frost point command will only contain a single numeric value.

Connection Wizard

How many data items does the response contain?

1

Enter the number of data items this response message contains. A data item is the numeric value or flag for a single device parameter. For example, if the response contains Dew Point, Frost Point and Pressure then you would have three data items. If the response only contains a single numeric value or flag then you would only have one data item for this response.

< Back **Next >** Finish Cancel

The first item is given the name Frost Point. The 373 can respond with a high precision numeric value so the Data Item Syntax was defined with the maximum digits possible that the 373 can respond with. The Data Item's Unit was defined as a temperature in degrees Celsius as stated in the documentation for the 373. The response value is the actual value so there is no need to define any type of scaling.

The screenshot shows the 'Connection Wizard' dialog box. It has three main input fields at the top: 'Data Item Name' containing 'Frost Point', 'Data Item Syntax' containing 'NNNNNNNNNNNNNNNNNN', and 'Data Item Unit' with a dropdown menu set to 'Temperature' and a unit dropdown set to '°C'. Below these is a checkbox labeled 'Also Calculate %RH at this Temperature' which is unchecked. To the left of the 'Scaling' table is a text box with instructions: 'Enter a name or description of the data item and define the syntax for the response using the coded symbols defined in the legend. Note that the syntax cannot contain both a Flag and Numeric syntax definition. If you require both, then create another data item to define them separately.' The 'Scaling' table has two columns: 'Signal Value' and 'Data Value', with three empty rows. To the right of the table is a 'Legend' box containing: 'X = Ignore', 'N = Numeric', and 'A = Flag'. Below the scaling table is a 'Response Syntax' field containing 'NNNNNNNNNNNNNNNN' in green text. At the bottom are four buttons: '< Back', 'Next >', 'Finish', and 'Cancel'.

According to the 373 documentation, each response is terminated with a carriage return and line feed.

The screenshot shows the 'Connection Wizard' dialog box at the 'End of Transmit (EOT) character sent after the response' step. A text box contains '<CR><LF>'. Below this is a text box with instructions: 'Select the ASCII character that is sent at the end of transmission of the response. Refer to the legend to enter special characters such as carriage returns or line feeds.' To the right is a 'Legend' box containing: '<CR> = Carriage Return', '<LF> = Line Feed', and '<T> = Tab'. At the bottom are four buttons: '< Back', 'Next >', 'Finish', and 'Cancel'.

Next, we define the command for the second response. Referring to the 373 documentation we enter the command for atmospheric pressure. Again, the command must be terminated with a carriage return or carriage return line feed combination.

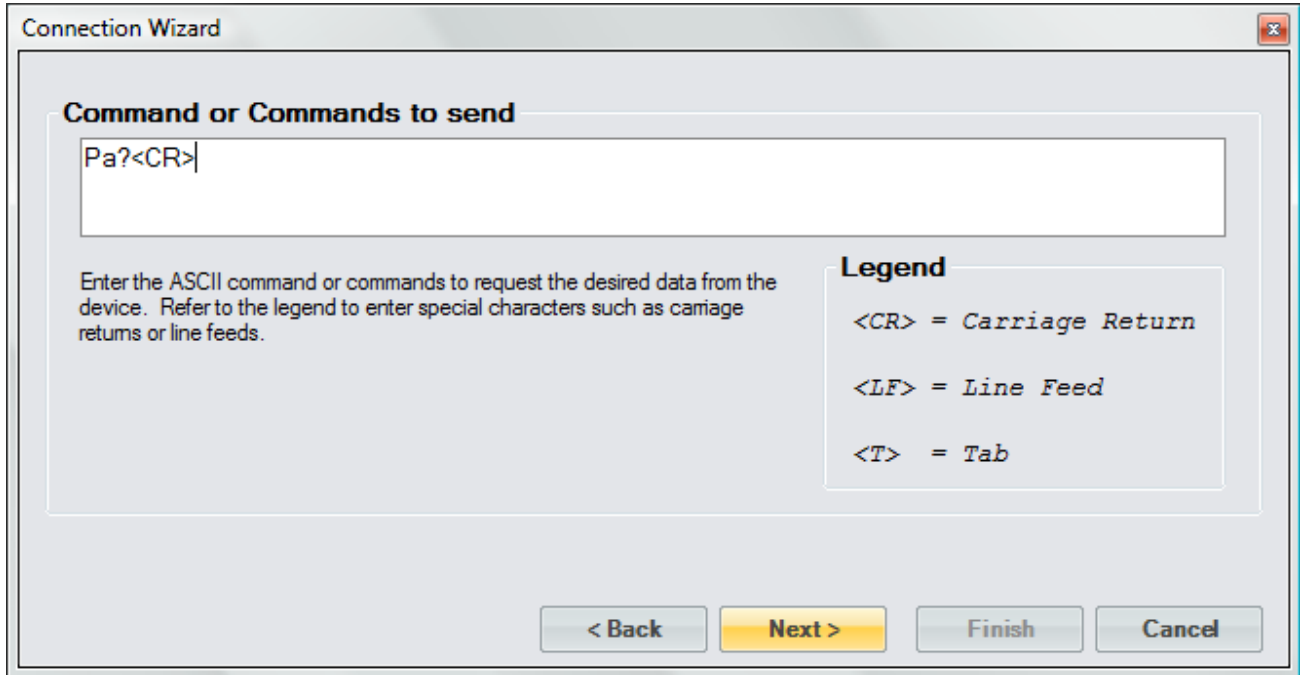

The 373 will respond to the atmospheric pressure command with a single numeric value and therefore no delimiter is used.

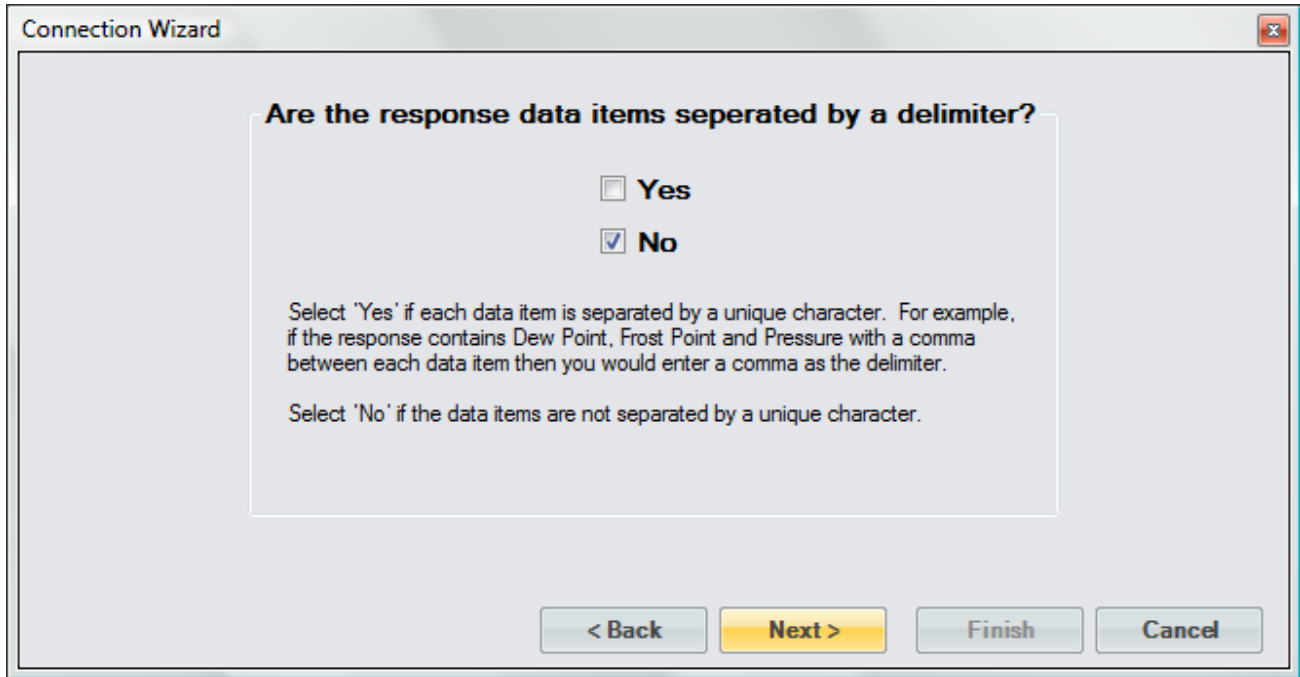

The response from the atmospheric pressure command will only contain a single numeric value.

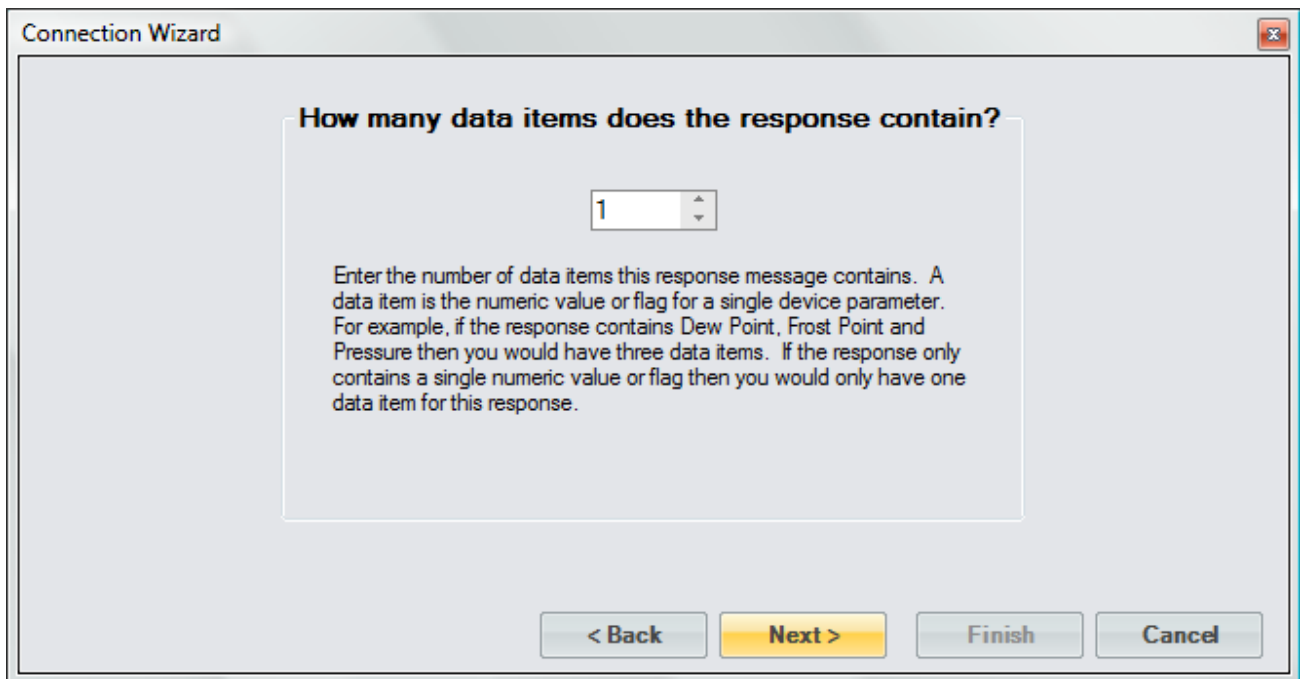

The second item is given the name, Pressure. Again, the Data Item Syntax was defined with the maximum digits possible that the 373 can respond with. The Data Item's Unit was defined as a pressure in Pascal as stated in the documentation. The response value is the actual value so there is no need to define any type of scaling.

The screenshot shows the 'Connection Wizard' dialog box. It has three main input fields at the top: 'Data Item Name' with the value 'Pressure', 'Data Item Syntax' with the value 'NNNNNNNNNNNNNNNNNN', and 'Data Item Unit' with a dropdown menu showing 'Pressure' and 'Pa'. Below these is a text area with instructions: 'Enter a name or description of the data item and define the syntax for the response using the coded symbols defined in the legend. Note that the syntax cannot contain both a Flag and Numeric syntax definition. If you require both, then create another data item to define them separately.' To the right of this text is a 'Scaling' table with two columns: 'Signal Value' and 'Data Value'. Below the table is a 'Legend' box containing: 'X = Ignore', 'N = Numeric', and 'A = Flag'. At the bottom left is a 'Response Syntax' field containing 'NNNNNNNNNNNNNNNN' in green text. At the bottom right are four buttons: '< Back', 'Next >', 'Finish', and 'Cancel'.

The response is terminated with a carriage return and line feed.

The screenshot shows the 'Connection Wizard' dialog box at a different step. The title is 'End of Transmit (EOT) character sent after the response'. There is a text input field containing '<CR><LF>'. Below this is a text area with instructions: 'Select the ASCII character that is sent at the end of transmission of the response. Refer to the legend to enter special characters such as carriage returns or line feeds.' To the right is a 'Legend' box containing: '<CR> = Carriage Return', '<LF> = Line Feed', and '<T> = Tab'. At the bottom right are four buttons: '< Back', 'Next >', 'Finish', and 'Cancel'.

Save the newly created device to a file so that it can be recalled at a later time.



Select to connect to the device now.



Select the port the 373 is connected to. Notice that ControLog indicates which ports are in use. Refer to the 373 documentation for specific port settings:

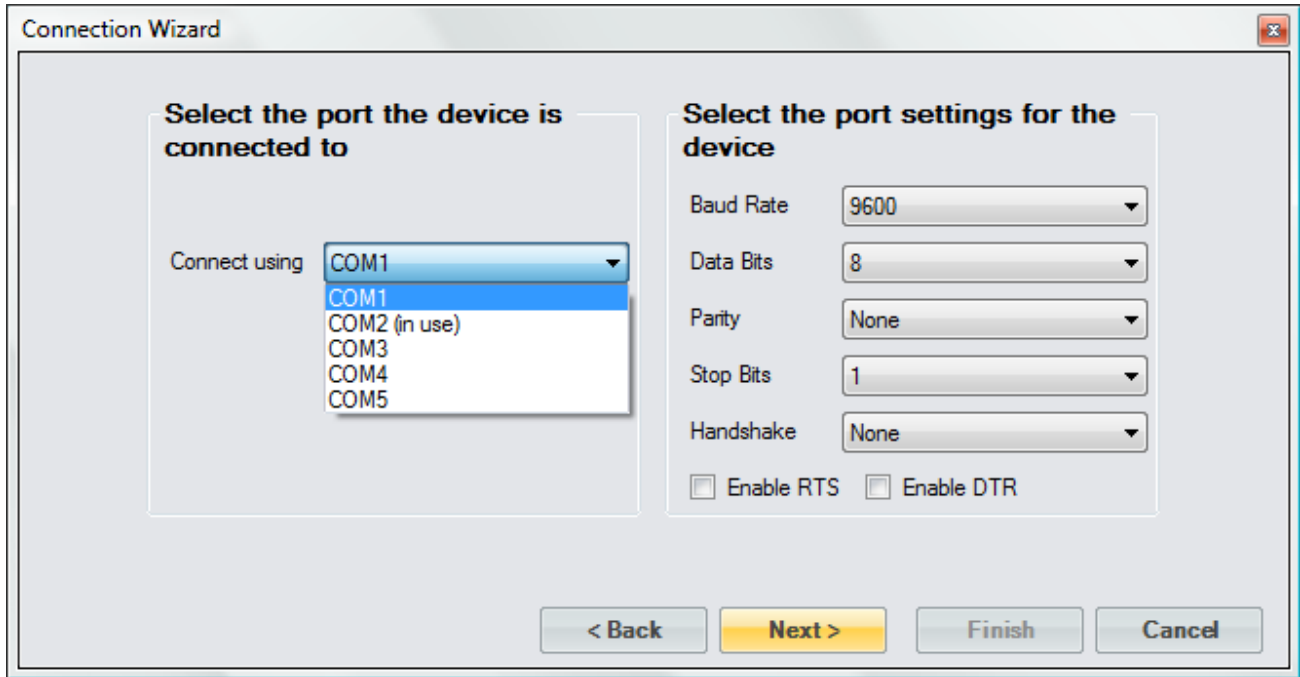

The default access interval of 1.5 seconds is entered.



Once completed, ControLog will attempt to establish communication with the 373.

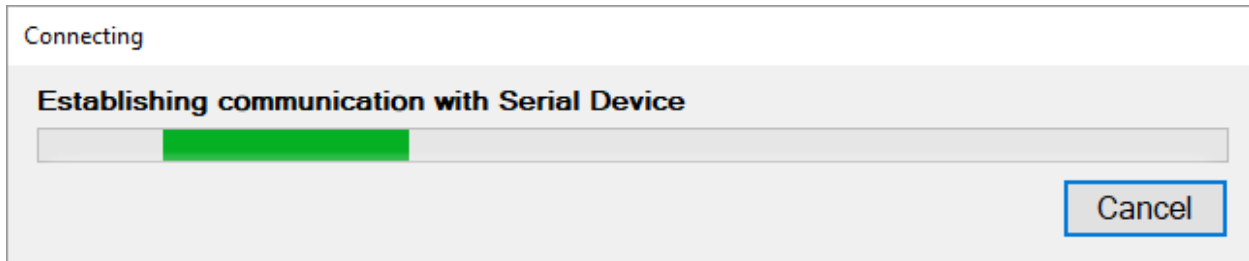

Once communication is successfully established with the 373, a new parameter tab and data tab will be created. Note that both the parameter tab and data tab have the two data items we defined. Notice that since we defined what unit the data items were received in, ControLog is able to convert the values into the selected units for easy reading.

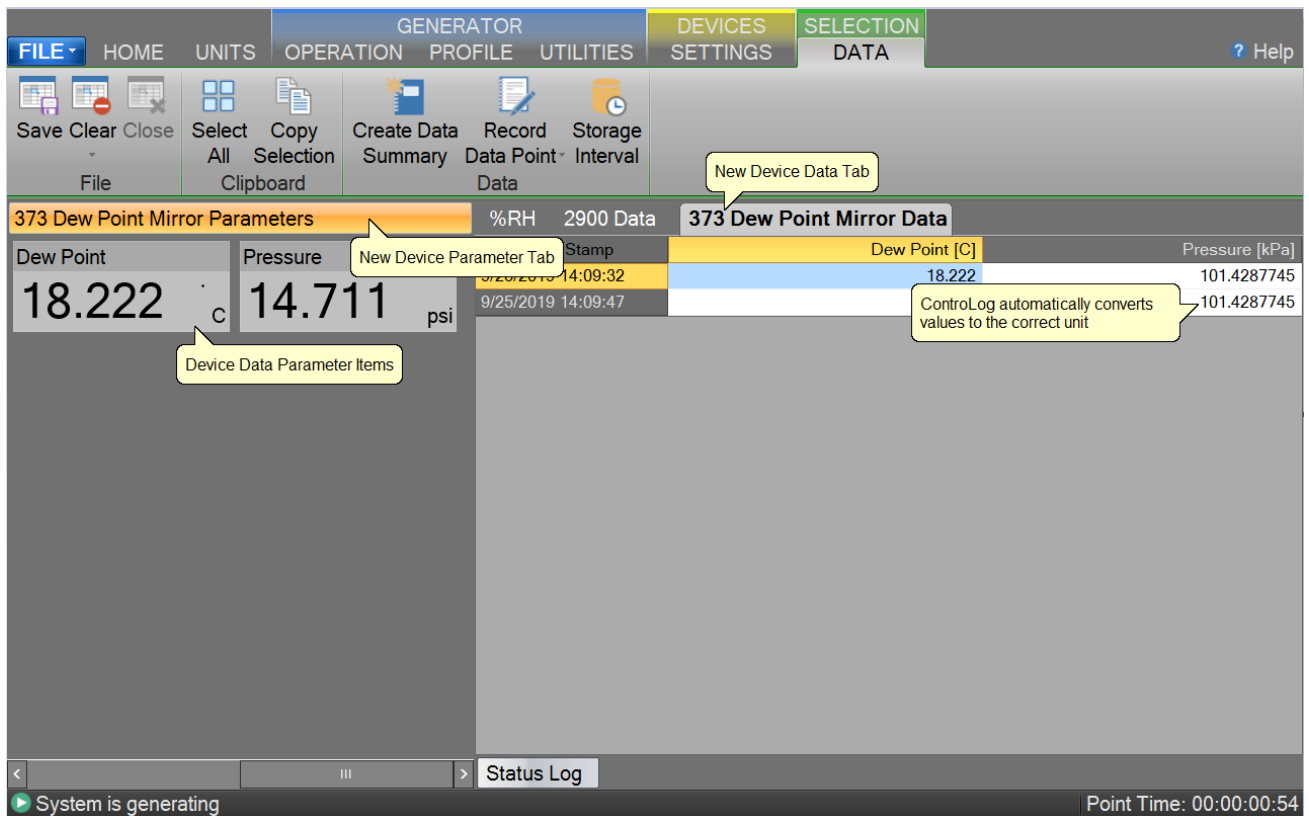

10.1.2 Serial Connection Example 2

This example will demonstrate the creation of a serial connection to an MBW® DP-30 Precision Dew Point Hygrometer. This example will be working with a DP-30 that has the temperature and pressure option. The DP-30 does not require any request to receive data. Instead, it constantly outputs three data messages at a periodic rate.

Start by selecting “New” from the Connections menu.

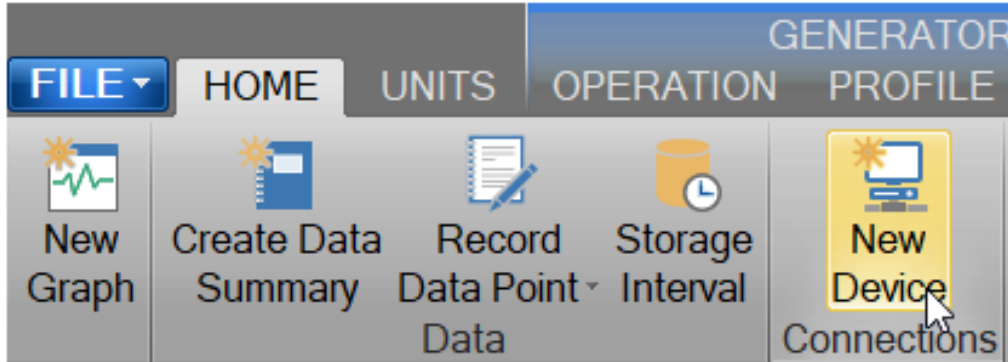

Select “Serial” as the type of device connection.

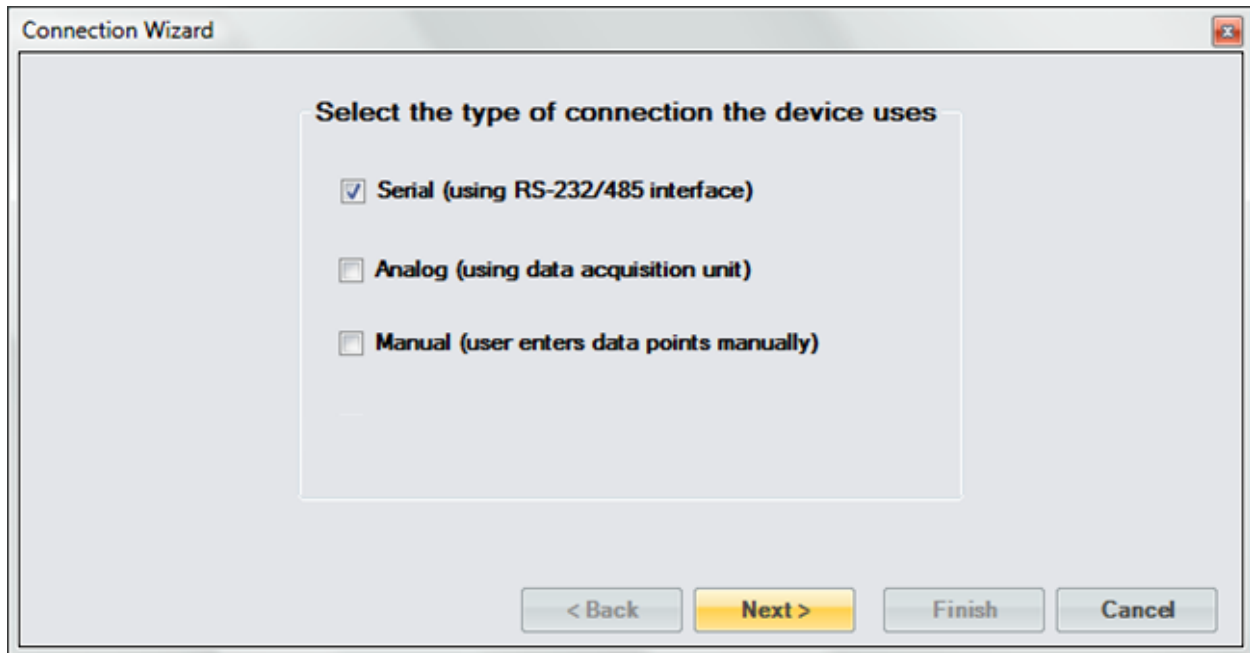

Enter "DP 30 with Options" as the name for the device.

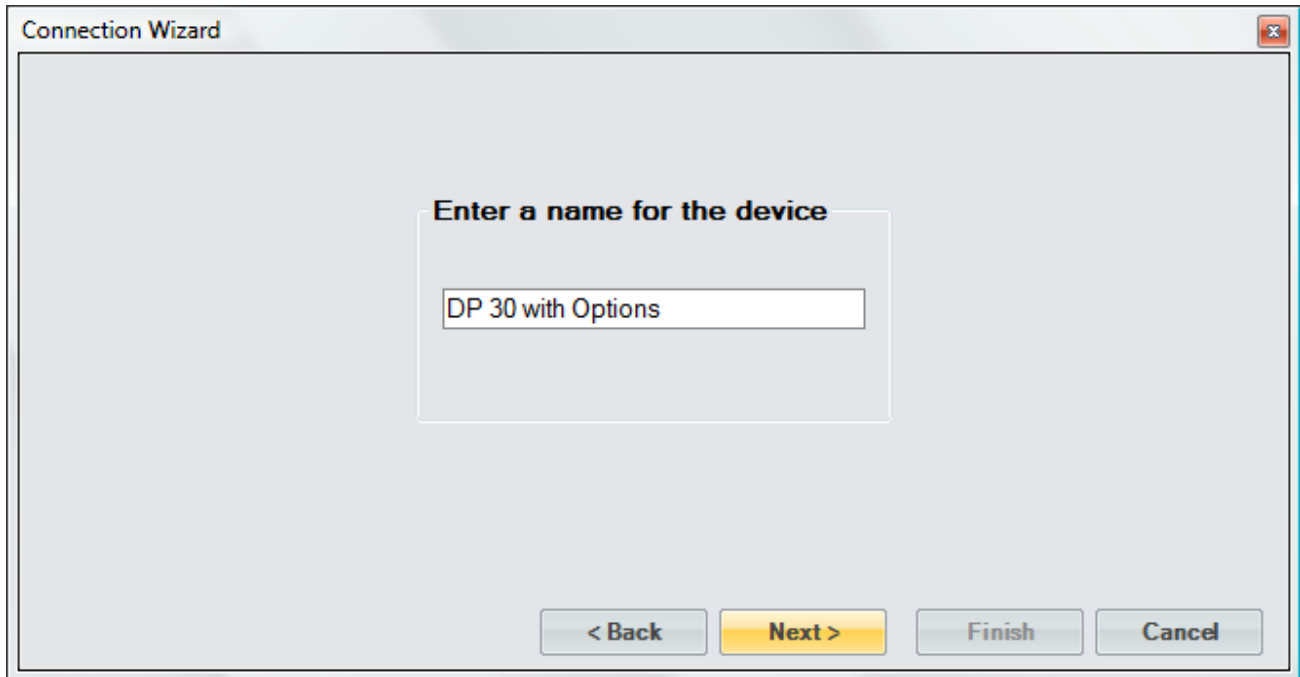

For the DP-30 we do not need to send any setup commands.



We will receive three responses from the DP-30; one with the Dew Point Temperature value and Status, one with the Dry Temperature value and one with the Pressure value.

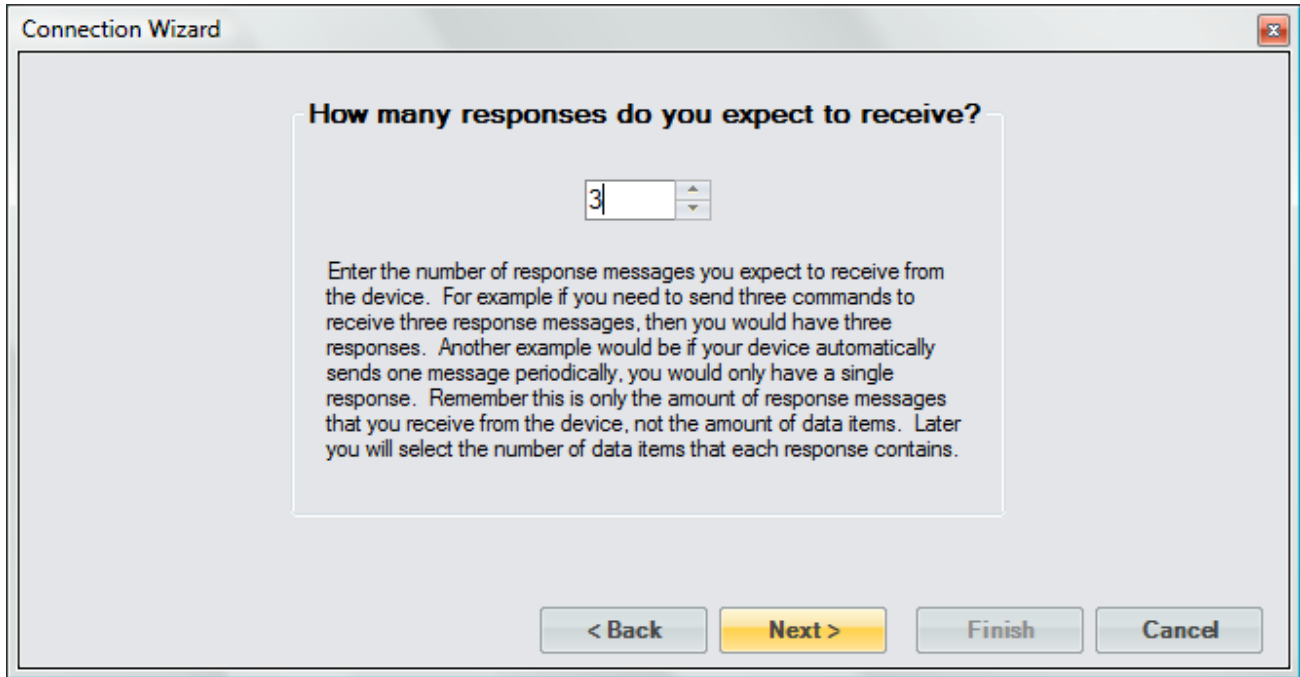

The DP-30 does not require any command to be sent to receive a response. The DP-30 automatically transmits the messages.



For the first message, we enter the response identification of the Dew Point Temperature message.

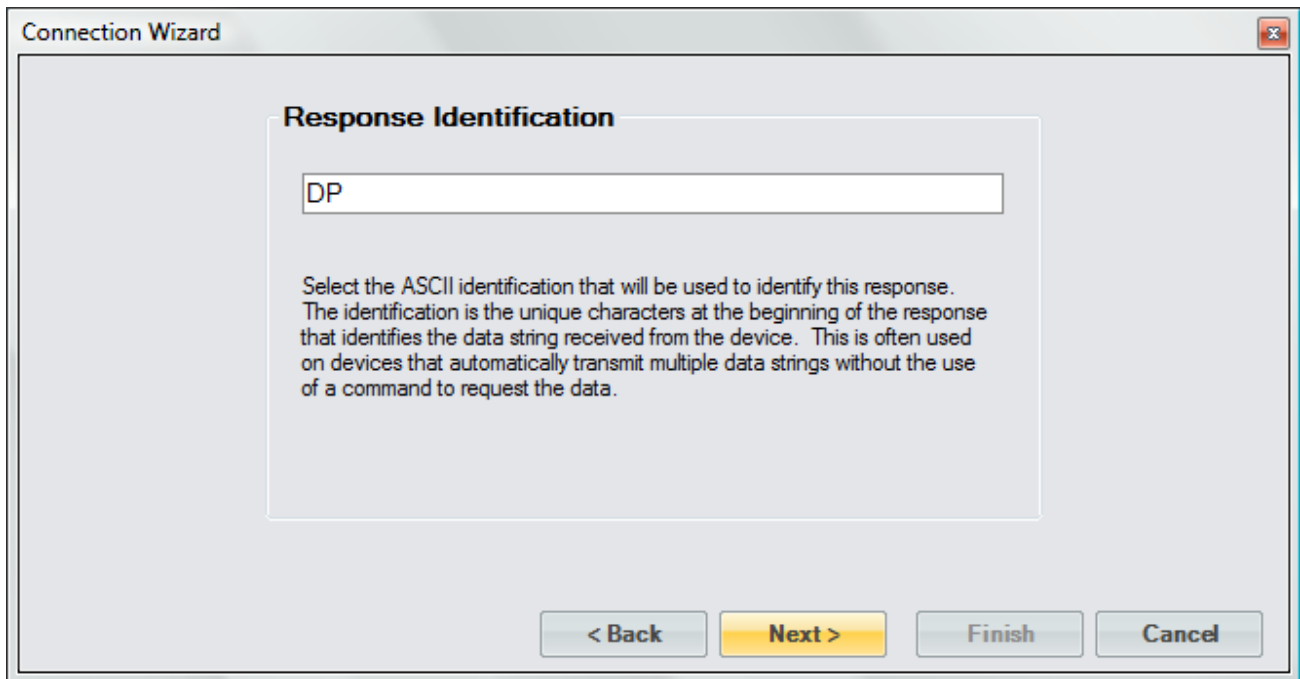

The screenshot shows a dialog box titled "Connection Wizard" with a close button in the top right corner. The main content area is titled "Response Identification" and contains a text input field with the text "DP". Below the input field is a paragraph of text: "Select the ASCII identification that will be used to identify this response. The identification is the unique characters at the beginning of the response that identifies the data string received from the device. This is often used on devices that automatically transmit multiple data strings without the use of a command to request the data." At the bottom of the dialog box are four buttons: "< Back", "Next >" (highlighted in yellow), "Finish", and "Cancel".

The DP-30 Dew Point Temperature message is of a fixed format and does not use any delimiter.

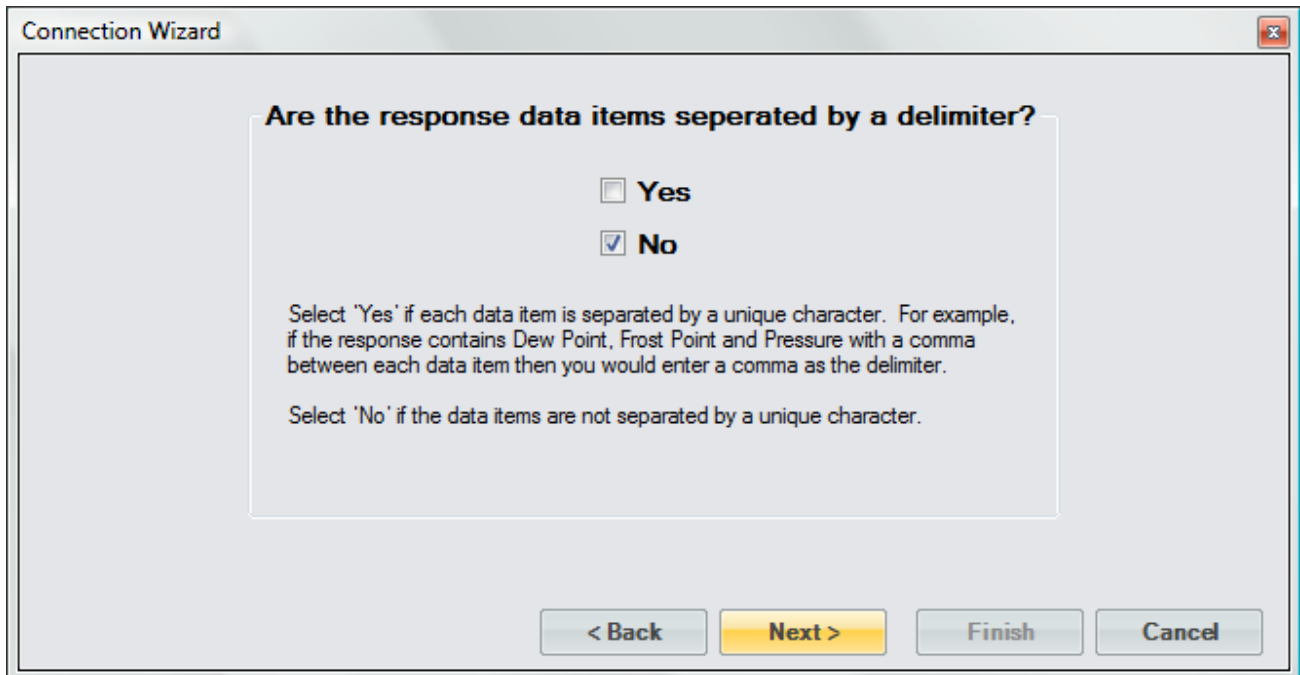

The screenshot shows a dialog box titled "Connection Wizard" with a close button in the top right corner. The main content area is titled "Are the response data items separated by a delimiter?" and contains two radio button options: "Yes" (unchecked) and "No" (checked). Below the options is a paragraph of text: "Select 'Yes' if each data item is separated by a unique character. For example, if the response contains Dew Point, Frost Point and Pressure with a comma between each data item then you would enter a comma as the delimiter. Select 'No' if the data items are not separated by a unique character." At the bottom of the dialog box are four buttons: "< Back", "Next >" (highlighted in yellow), "Finish", and "Cancel".

The Dew Point Temperature message contains three flags and one value that results in a total of four data items for this response.

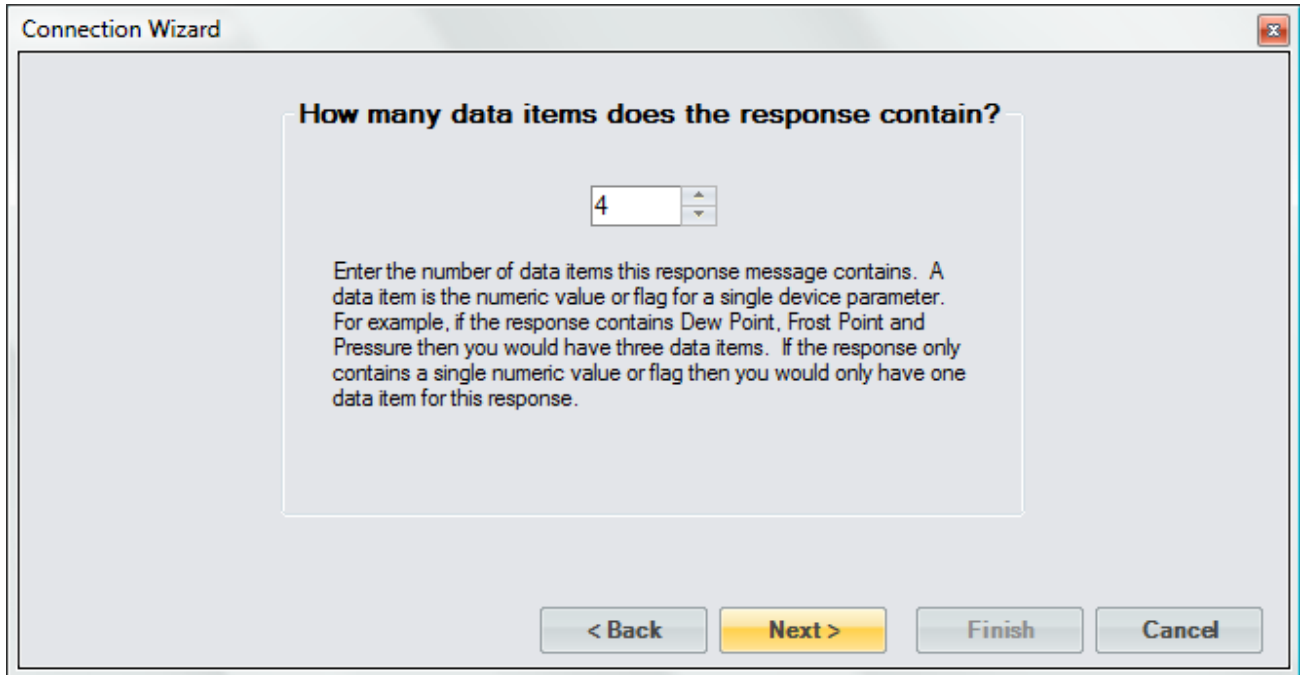

The first data item is a flag indicating whether the DP-30 is balanced. The DP-30 will send a “*” indicating that it is not balanced or a “B” indicating that it is balanced. Since we are not interested in the next two characters after this flag in the message we will tell ControlLog to ignore them by adding two “X”s after the flag symbol. Next, we define these flag definitions and give them a simple “Yes” or “No” description to allow the user to easily determine their state in the parameter tab.

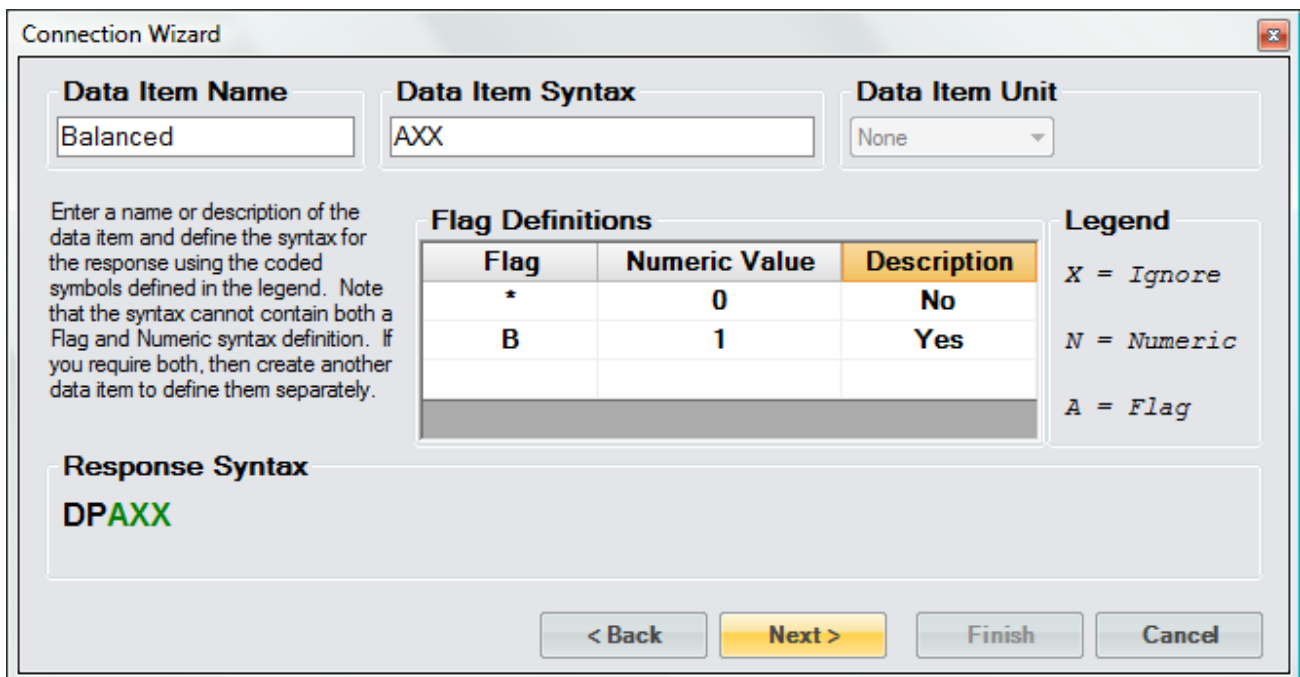

The second data item is a flag indicating whether the DP-30 is running. The DP-30 will send a “*” indicating that it is not running or an “S” indicating that it is running. We again define these flag definitions and give them a simple “Yes” or “No” description to allow the user to easily determine the state in the parameter tab.

Connection Wizard

Data Item Name Run **Data Item Syntax** A **Data Item Unit** None

Enter a name or description of the data item and define the syntax for the response using the coded symbols defined in the legend. Note that the syntax cannot contain both a Flag and Numeric syntax definition. If you require both, then create another data item to define them separately.

Flag Definitions

Flag	Numeric Value	Description
*	0	No
R	1	Yes

Legend

X = Ignore
 N = Numeric
 A = Flag

Response Syntax
 DPAXXA

< Back Next > Finish Cancel

The third data item is a flag indicating whether the DP-30 is in standby. The DP-30 will send a “*” indicating that it is not in standby or an “S” indicating that it is in standby. We again define these flag definitions and give them a simple “Yes” or “No” description to allow the user to easily determine the state in the parameter tab.

Connection Wizard

Data Item Name Standby **Data Item Syntax** A **Data Item Unit** None

Enter a name or description of the data item and define the syntax for the response using the coded symbols defined in the legend. Note that the syntax cannot contain both a Flag and Numeric syntax definition. If you require both, then create another data item to define them separately.

Flag Definitions

Flag	Numeric Value	Description
*	0	No
S	1	Yes

Legend

X = Ignore
 N = Numeric
 A = Flag

Response Syntax
 DPAXXAA

< Back Next > Finish Cancel

The fourth data item is the dew point temperature value. The DP-30 will send a numeric value indicating the dew point temperature in degrees Celsius. We define the syntax exactly as the DP-30 documentation specifies. The response value is the actual value so there is no need to define any type of scaling.

Connection Wizard

Data Item Name: Dew Point

Data Item Syntax: +NNN.NN

Data Item Unit: Temperature °C

Also Calculate %RH at this Temperature

Enter a name or description of the data item and define the syntax for the response using the coded symbols defined in the legend. Note that the syntax cannot contain both a Flag and Numeric syntax definition. If you require both, then create another data item to define them separately.

Signal Value	Data Value

Legend

- X = Ignore
- N = Numeric
- A = Flag

Response Syntax

DPAXXAA+NNN.NN

< Back Next > Finish Cancel

Notice that ControLog shows the combined response syntax for this message at the bottom of the form. This syntax will closely resemble the syntax defined in the DP-30 documentation for the dew point temperature message. The Green portion of the syntax is the current data item’s syntax within the response message.

Response Syntax

DPAXXAA+NNN.NN

The Dew Point Temperature message is terminated with a carriage return.

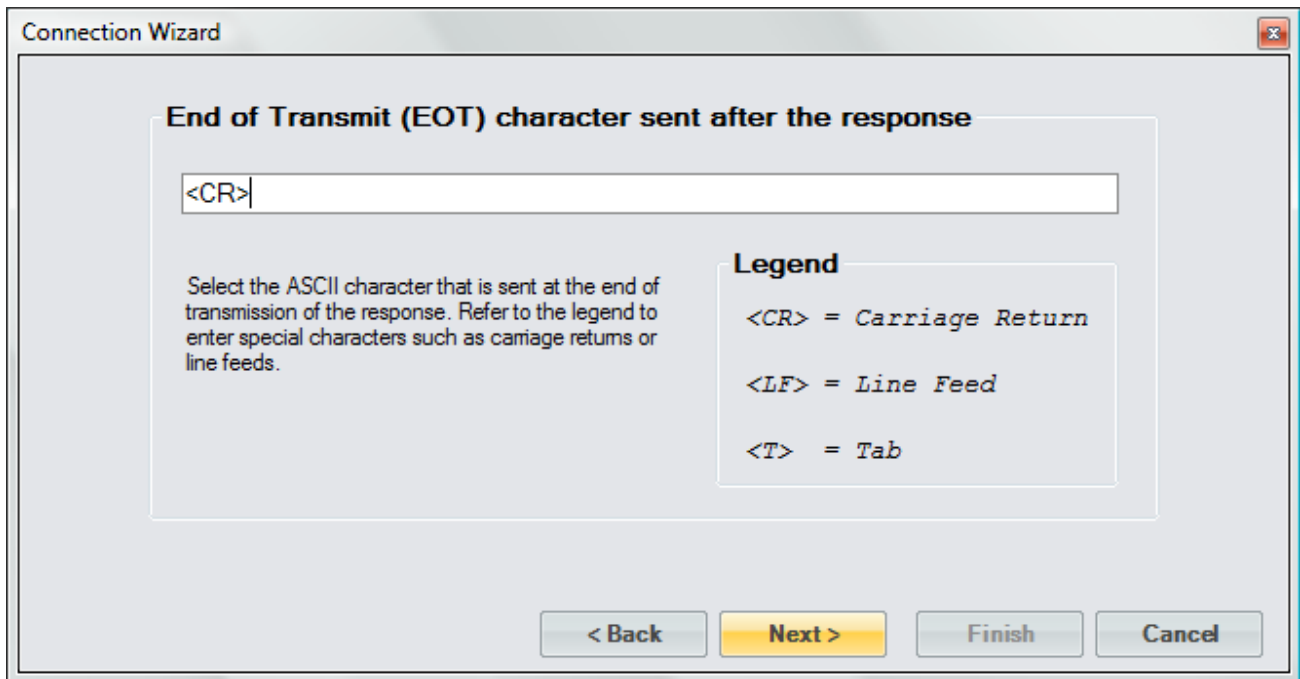

Next, we define the response identification for the second message. Referring to the DP-30 documentation we enter the identification for the Dry Temperature message.

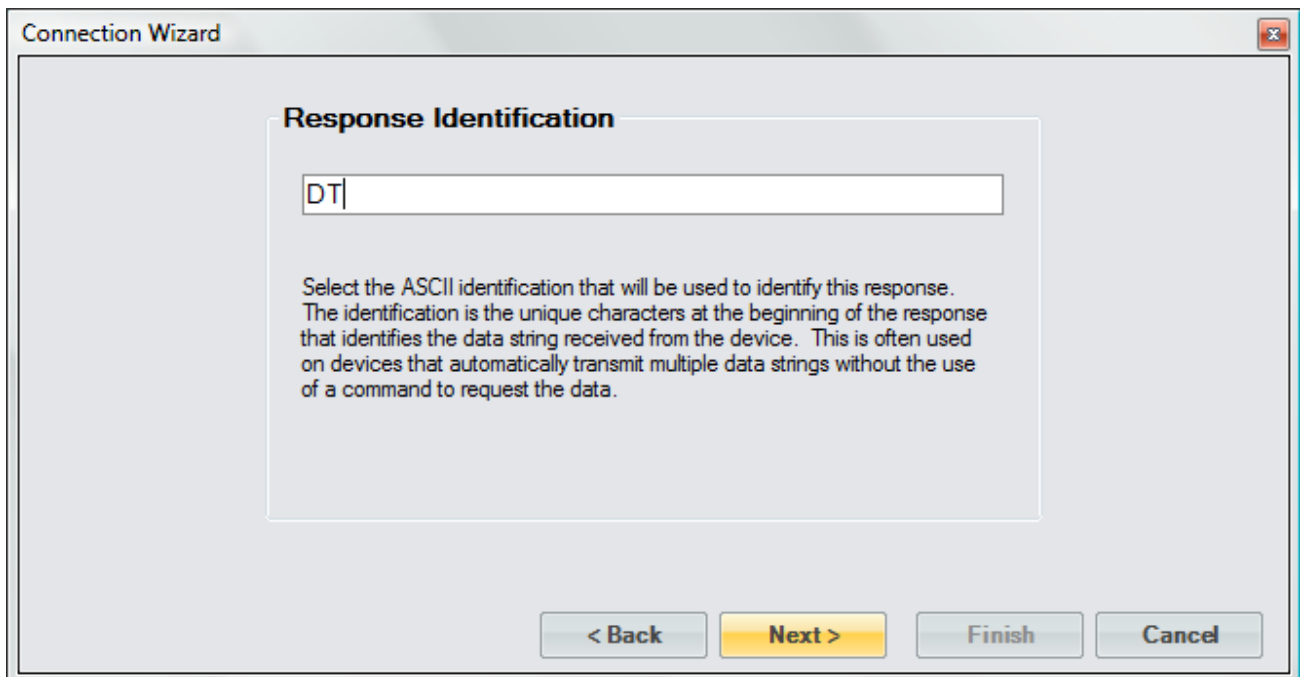

The DP-30 Dry Temperature message is of a fixed format and does not use any delimiter.

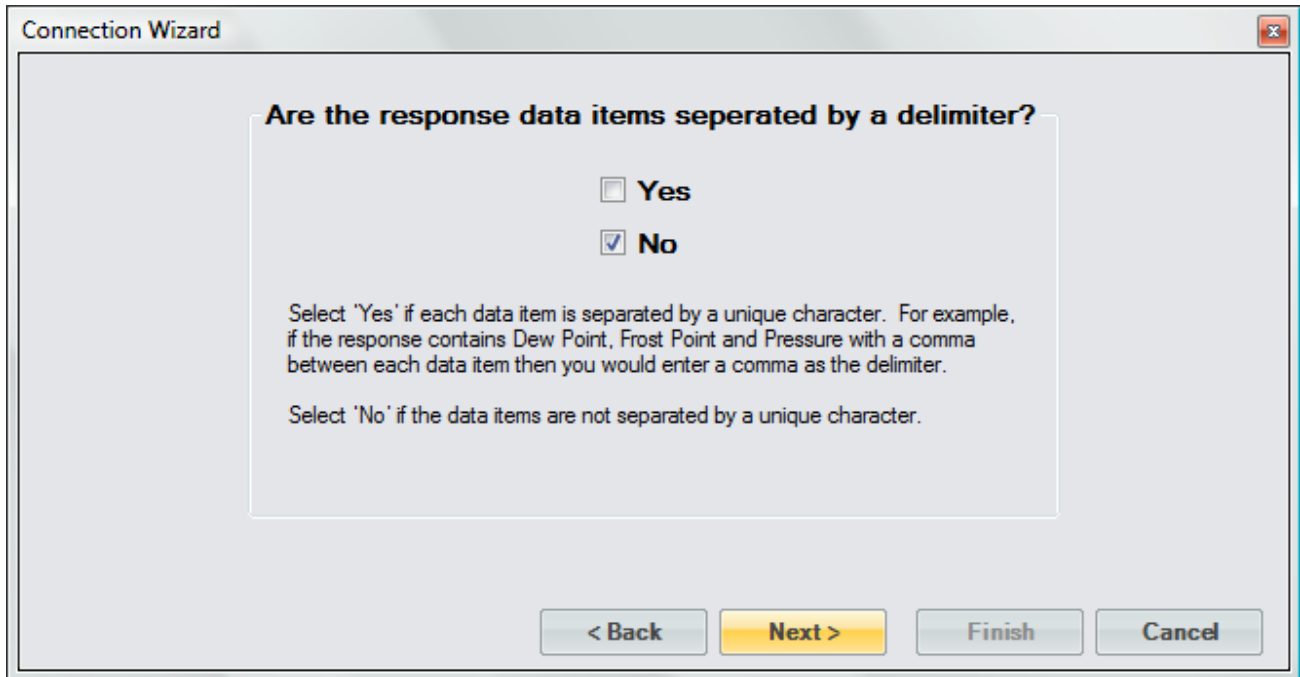

The Dry Temperature message contains only one numeric value; therefore, there is only one data item for this response.

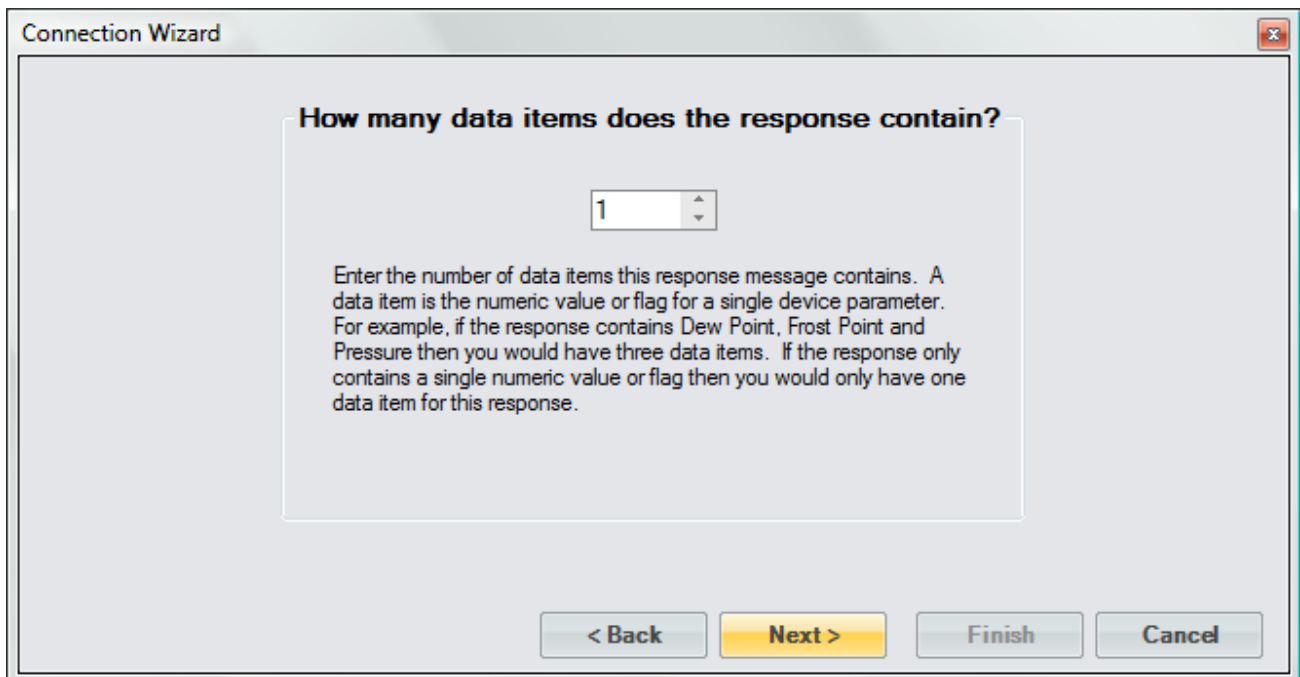

The message is led by a number of ASCII characters that we do not have any interest in. We will tell ControLog to ignore these leading characters by defining the syntax with five “X” characters then the numeric syntax. We define the numeric syntax exactly as the DP-30 documentation specifies. Again, the response value is the actual value so there is no need to define any type of scaling.

The screenshot shows the 'Connection Wizard' dialog box. It has three main input fields at the top: 'Data Item Name' with the value 'Temperature', 'Data Item Syntax' with the value 'XXXXX+NNN.NN', and 'Data Item Unit' with a dropdown menu showing 'Temperature' and a unit dropdown showing '°C'. Below these is a checkbox labeled 'Also Calculate %RH at this Temperature' which is unchecked. To the left of the 'Scaling' table is a text box with instructions: 'Enter a name or description of the data item and define the syntax for the response using the coded symbols defined in the legend. Note that the syntax cannot contain both a Flag and Numeric syntax definition. If you require both, then create another data item to define them separately.' The 'Scaling' table has two columns: 'Signal Value' and 'Data Value', with three empty rows. To the right of the table is a 'Legend' box containing: 'X = Ignore', 'N = Numeric', and 'A = Flag'. Below the scaling table is a 'Response Syntax' field containing the text 'DTXXXXX+NNN.NN' in green. At the bottom are four buttons: '< Back', 'Next >', 'Finish', and 'Cancel'.

The Dry Temperature message is terminated with a carriage return.

The screenshot shows the 'Connection Wizard' dialog box at a later step. The title is 'End of Transmit (EOT) character sent after the response'. There is a text input field containing '<CR>'. Below the field is a text box with instructions: 'Select the ASCII character that is sent at the end of transmission of the response. Refer to the legend to enter special characters such as carriage returns or line feeds.' To the right is a 'Legend' box containing: '<CR> = Carriage Return', '<LF> = Line Feed', and '<T> = Tab'. At the bottom are four buttons: '< Back', 'Next >', 'Finish', and 'Cancel'.

We now define the response identification for the third and last message. Referring to the DP-30 documentation we enter the identification for the Pressure message.

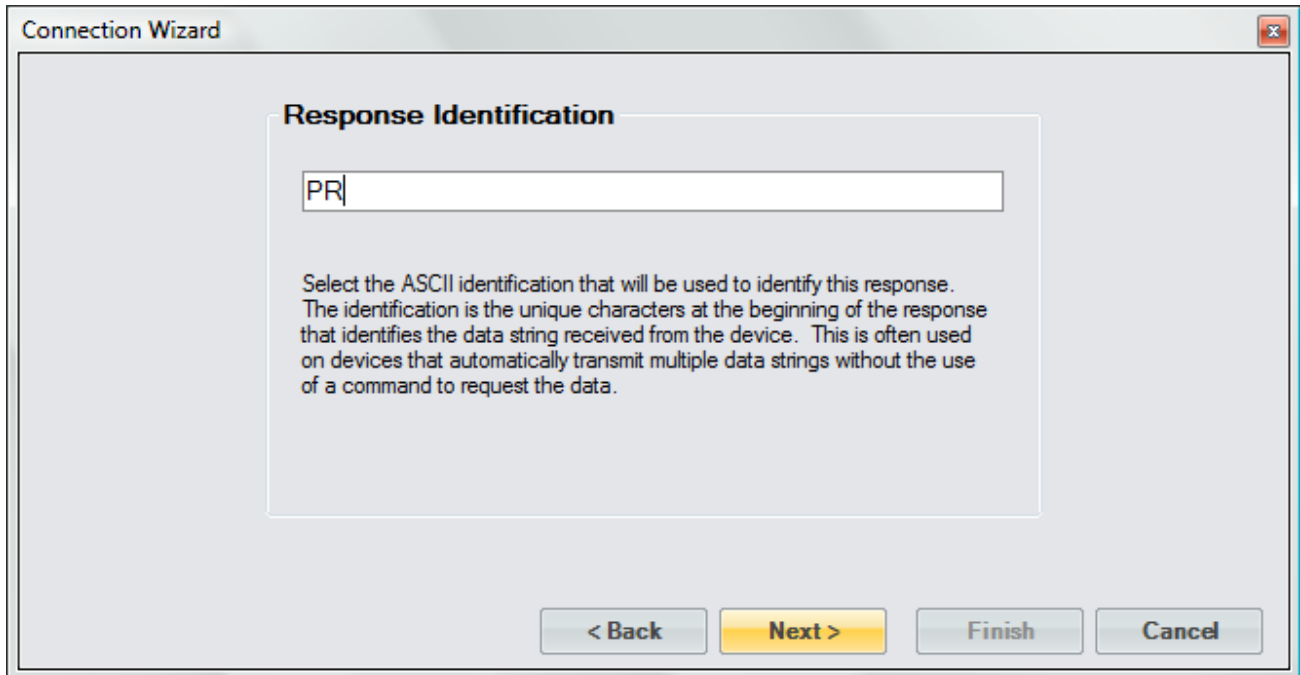

The DP-30 Pressure message is of a fixed format and does not use any delimiter.

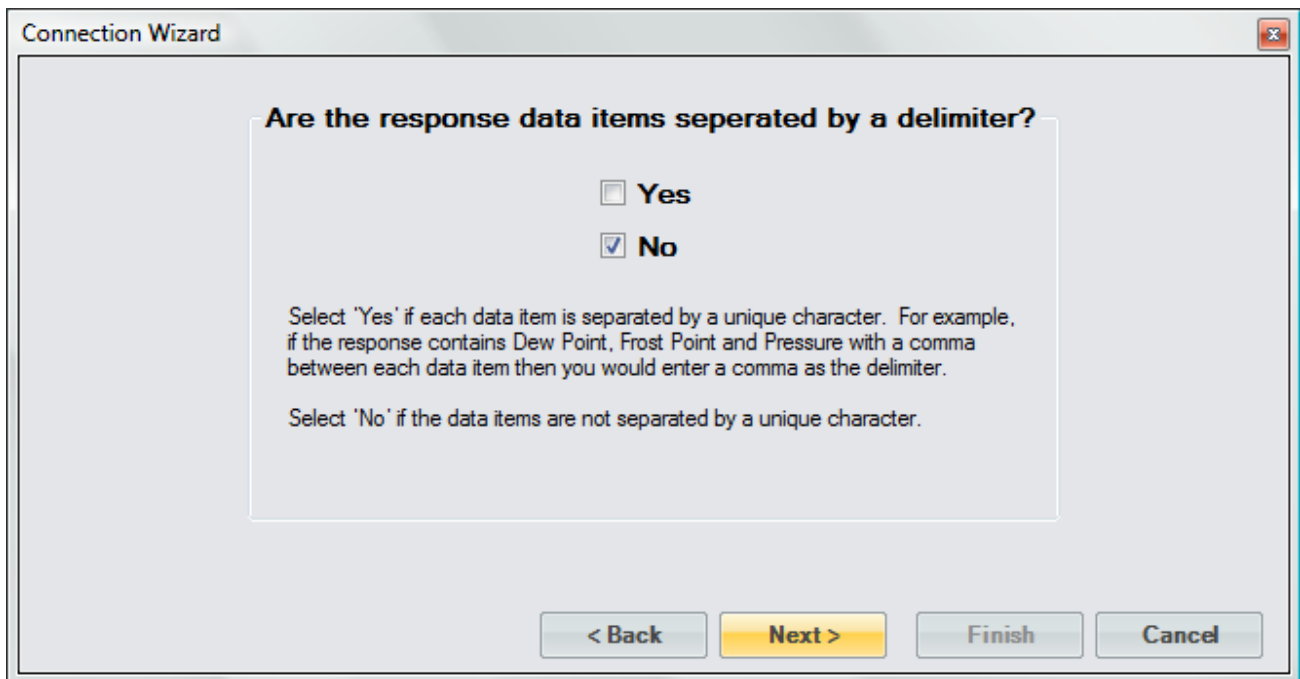

The Pressure message contains only one numeric value therefore there is only one data item for this response.

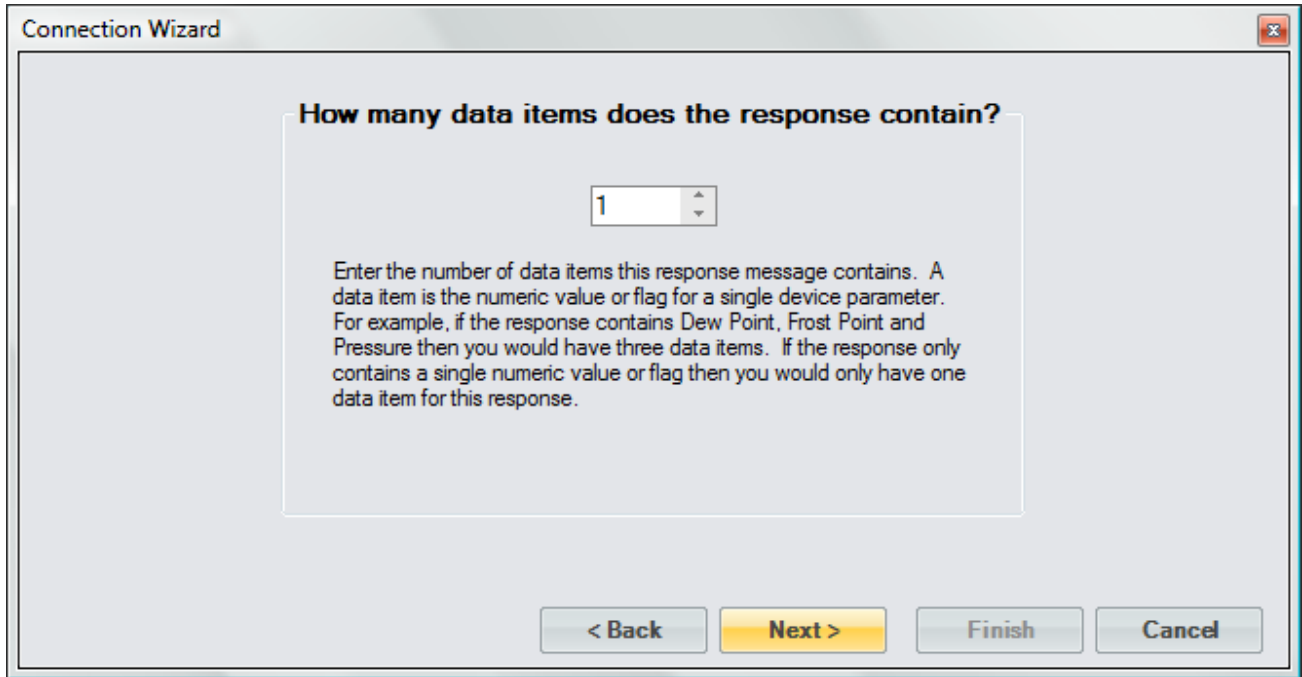

Again, the message is led by a number of ASCII characters that we do not have any interest in. We will tell ControLog to ignore these leading characters by defining the syntax with five “X” characters then the numeric syntax. We define the numeric syntax exactly as the DP-30 documentation specifies. Note that we set the data item unit to the unit specified in the DP-30 documentation. This allows ControLog to convert the reading into a more desired unit if needed. Again, the response value is the actual value so there is no need to define any type of scaling.

Connection Wizard

Data Item Name: Pressure

Data Item Syntax: XXXXX+NNN.NN

Data Item Unit: Pressure (unit), bar (unit)

Enter a name or description of the data item and define the syntax for the response using the coded symbols defined in the legend. Note that the syntax cannot contain both a Flag and Numeric syntax definition. If you require both, then create another data item to define them separately.

Signal Value	Data Value

Legend

- X = Ignore
- N = Numeric
- A = Flag

Response Syntax

PRXXXXX+NNN.NN

< Back **Next >** Finish Cancel

The Pressure message is terminated with a carriage return.

Connection Wizard

End of Transmit (EOT) character sent after the response

<CR>

Select the ASCII character that is sent at the end of transmission of the response. Refer to the legend to enter special characters such as carriage returns or line feeds.

Legend

- <CR> = Carriage Return
- <LF> = Line Feed
- <T> = Tab

< Back **Next >** Finish Cancel

Save the newly created device to a file so that it can be recalled at a later time.



Select to connect to the device now.



Select the port the DP-30 is connected to. Notice that ControLog indicates which ports are in use. Refer to the DP-30 documentation for the RS-232 port settings:

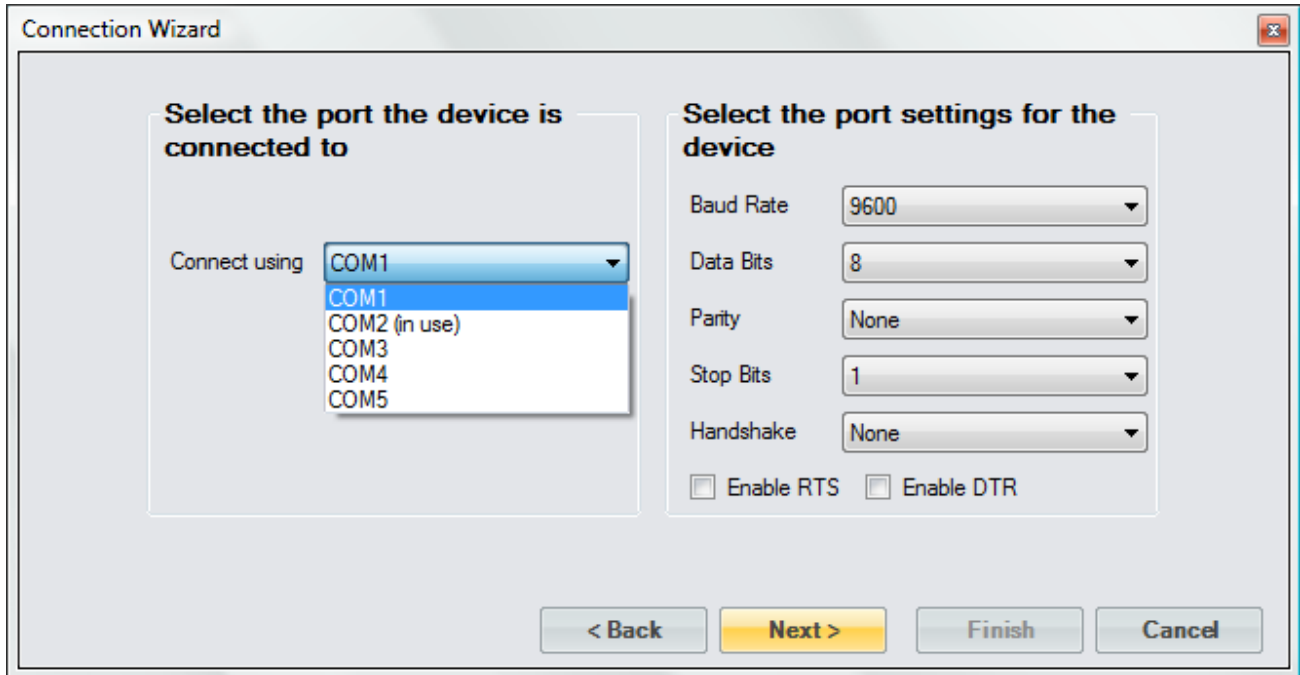

Use the default access rate of 1.5 seconds.

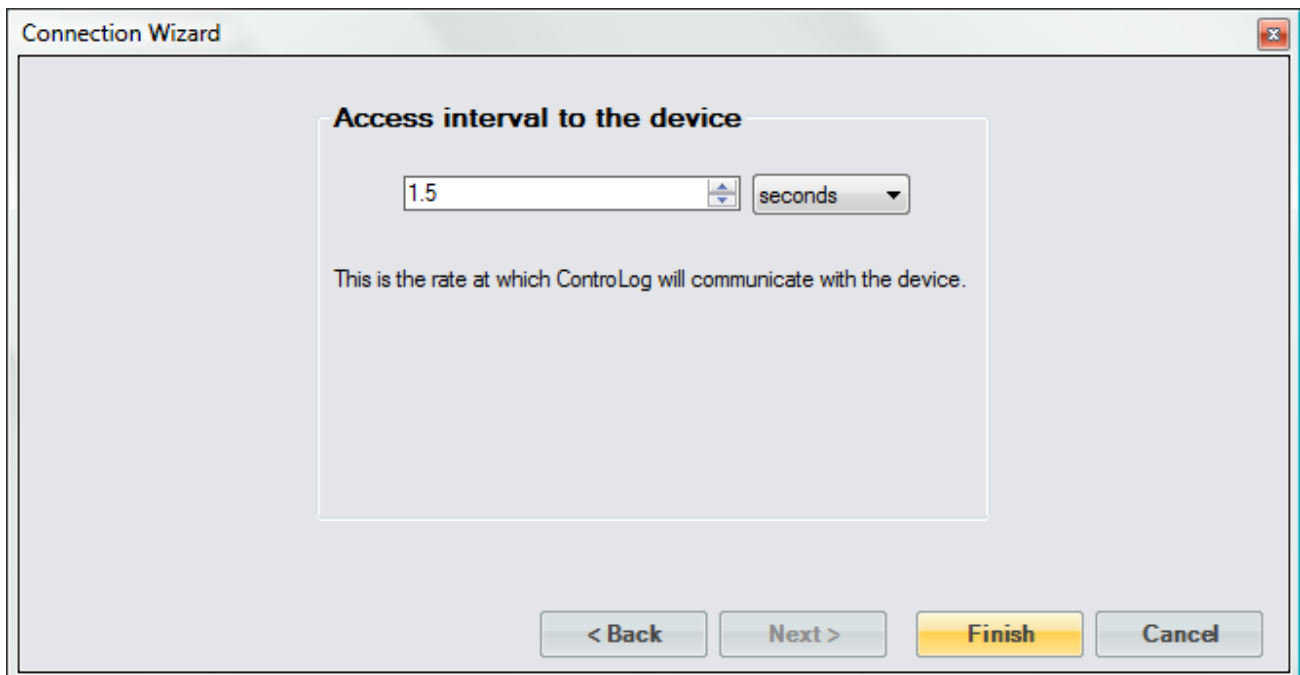

Once completed, ControLog will attempt to establish communication with the DP-30.

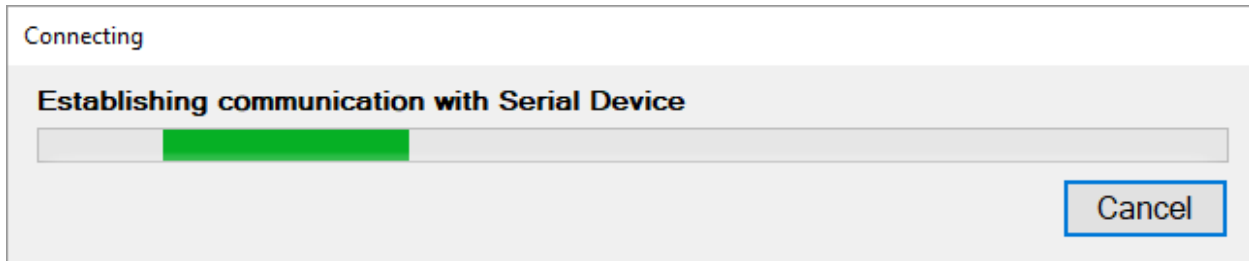

Once communication is successfully established with the DP-30, a new parameter tab and data tab will be created. Notice that ControLog automatically translates the ASCII flags based on the definitions described when creating the data items for the connection.

MBW DP30 Parameters

Balanced	Run
Yes	Yes
Standby	Dew Point Temperature
No	14.868
Dry Temperature	
21.819	

MBW DP30 Data

Date/Time Stamp	Balanced	Run	Standby	Dew Point Temperature
11/14/2017 8:54:19	1	1	0	1
11/14/2017 8:54:49	1	1	0	1
11/14/2017 8:55:19	1	1	0	1
11/14/2017 8:55:49	1	1	0	1

Status Log

```

11/14/2017 8:52:19 AM: Generate Mode Enabled
11/14/2017 8:52:19 AM: Filling Pre-Saturator
11/14/2017 8:52:20 AM: Communication established with the 2900 generator (S/N 0000000)
11/14/2017 8:53:14 AM: Communication established with the MBW DP30 device
11/14/2017 8:53:52 AM: 'MBW DP30 Data' cleared by user
    
```

System is generating

10.2 ANALOG CONNECTION

An Analog Connection uses the Agilent® 34970A Data Acquisition/Switch Unit to acquire data from single or multiple analog devices. The customizable interface provided by ControLog allows the user to define different analog types and scales to read various analog signals. Refer to the Agilent® documentation for more information on connecting analog devices to the Data Acquisition Unit.

To create a new analog connection, select “New” from the Connections menu. This will open a “Connection Wizard” dialog that will step the user through the connection definition process.

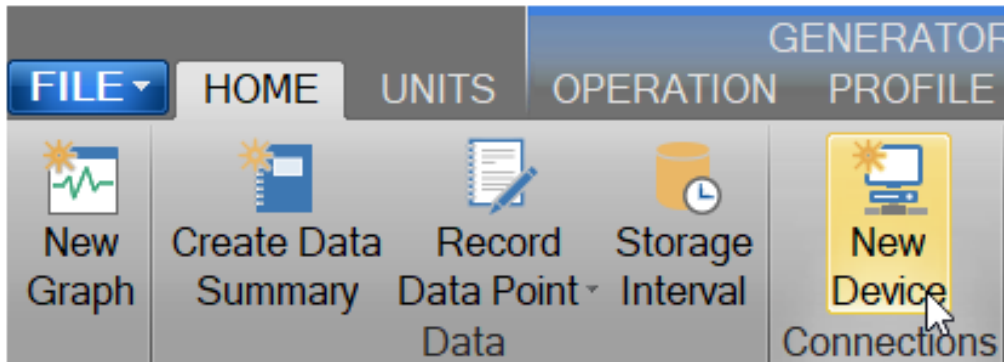

Select “Analog” as the type of connection the device uses.

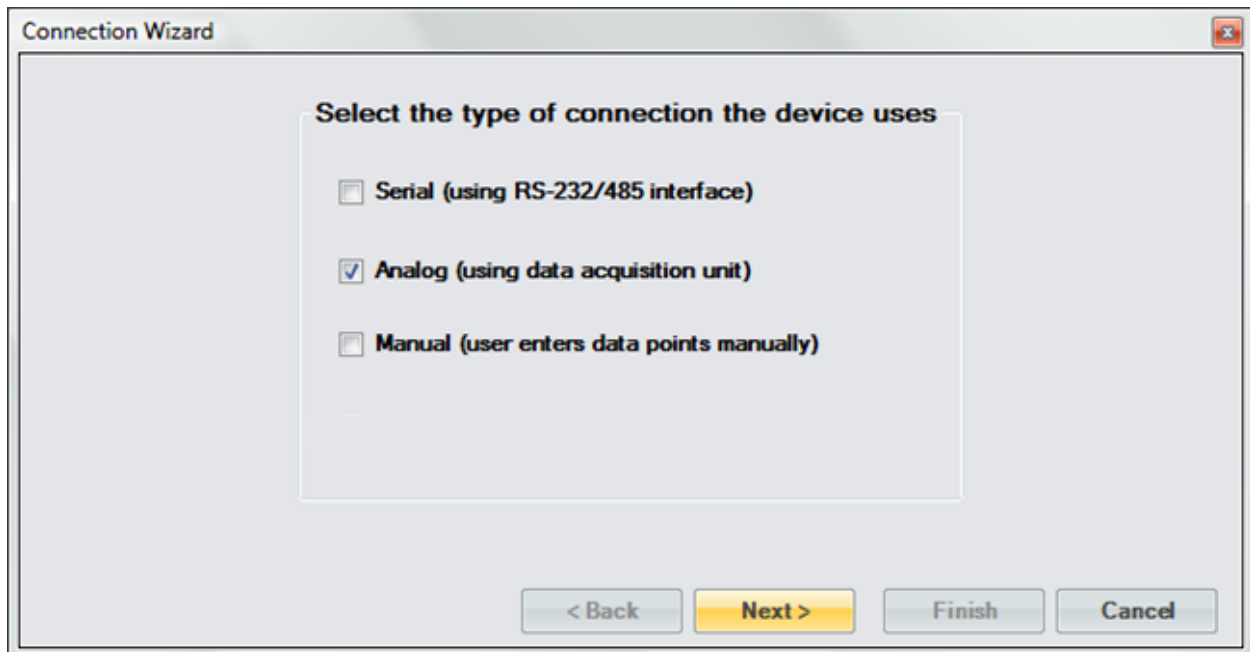

Enter a unique name for the analog device or devices.



The screenshot shows a window titled "Connection Wizard" with a close button in the top right corner. The main area contains the text "Enter a name for the device" above a text input field. At the bottom, there are four buttons: "< Back", "Next >" (highlighted in yellow), "Finish", and "Cancel".

Enter the number of analog signals you want to monitor. This is the combined number of analog signals from each device you wish to monitor. Each analog signal connected to the 34970A will represent a single data item parameter.

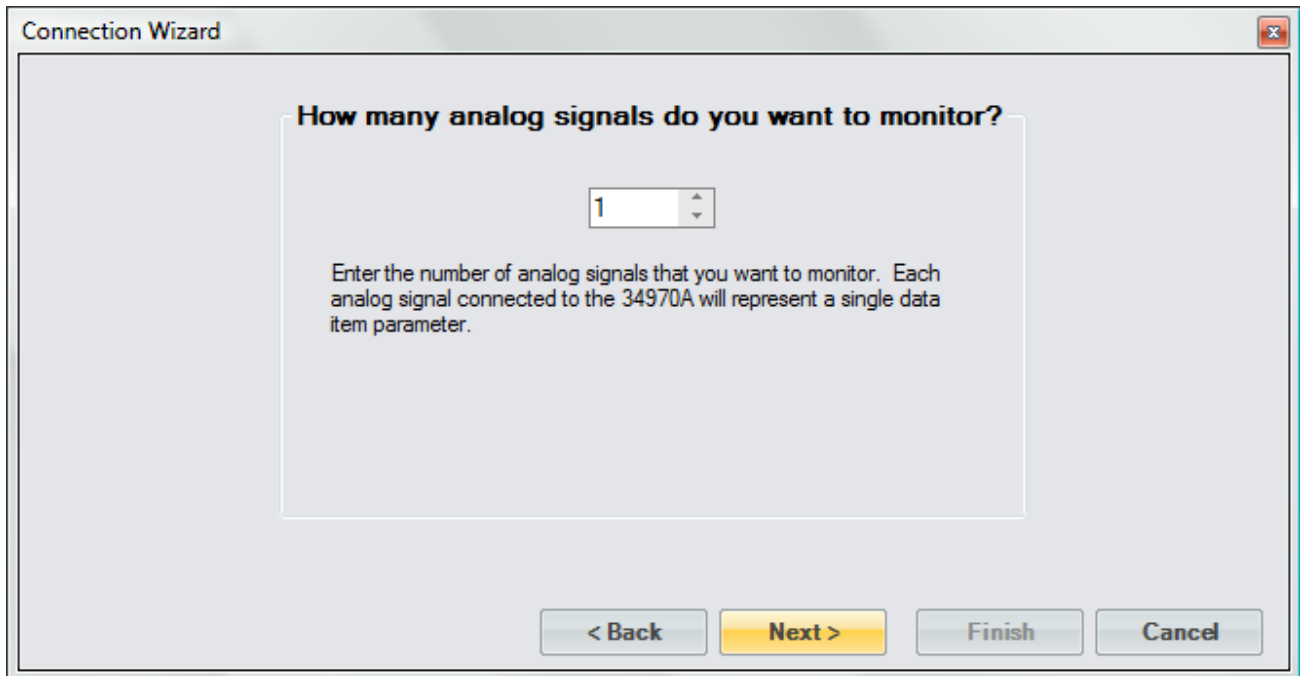

The screenshot shows a window titled "Connection Wizard" with a close button in the top right corner. The main area contains the text "How many analog signals do you want to monitor?" above a spin box containing the number "1". Below the spin box is the text: "Enter the number of analog signals that you want to monitor. Each analog signal connected to the 34970A will represent a single data item parameter." At the bottom, there are four buttons: "< Back", "Next >" (highlighted in yellow), "Finish", and "Cancel".

Enter a name or description of the data item and define the analog channel for it. The channel is the corresponding instrument channel the device is connected to. For 4-wire measurements, the instrument automatically pairs channel n with channel n+10 to provide the source and sense connections. This dialog will repeat for each monitored signal.

Connection Wizard

Data Item Name

Channel 101

Function Volts DC

Range 300 V

Enter a name or description of the data item and define the analog channel for it. The channel is the corresponding instrument channel that the device is connected to. For 4-wire measurements, the instrument automatically pairs channel n with channel n+10 to provide the source and sense connections. The function defines what type of analog signal the device uses. The range specifies the range for which the analog signal operates within. The scaling allows you to scale the analog signal into a given humidity value. For example, if you have an analog signal that ranges from 0 volts to 5 volts and it is known that 0 volts corresponds to 0% RH and 5 volts corresponds to 100%RH. You can then enter these scaling values and ControLog will automatically apply the scaling to the data item whenever it is displayed or logged.

Data Item Unit None

Scaling

Signal Value	Data Value

< Back Next > Finish Cancel

The function defines what type of analog signal the device uses.

Connection Wizard

Data Item Name

Channel 101

Function Volts DC

Range 300 V

Enter a name or description of the data item and define the analog channel for it. The channel is the corresponding instrument channel that the device is connected to. For 4-wire measurements, the instrument automatically pairs channel n with channel n+10 to provide the source and sense connections. The function defines what type of analog signal the device uses. The range specifies the range for which the analog signal operates within. The scaling allows you to scale the analog signal into a given humidity value. For example, if you have an analog signal that ranges from 0 volts to 5 volts and it is known that 0 volts corresponds to 0% RH and 5 volts corresponds to 100%RH. You can then enter these scaling values and ControLog will automatically apply the scaling to the data item whenever it is displayed or logged.

Data Item Unit Data Value

< Back Next > Finish Cancel

The range specifies the range for which the analog signal operates within. The available range selection changes automatically to reflect what is available for the selected function. For example, the Resistance function has a Range from 100 Ohms to 100 Mega Ohms.

Connection Wizard

Data Item Name

Channel 101

Function Resistance

Range 100 MΩ

Data Item Unit None

Scaling

Signal Value	Data Value

Enter a name or description of the data item and define the analog channel for it. The channel is the corresponding instrument channel that the device is connected to. For 4-wire measurements, the instrument automatically pairs channel n with channel n+10 to provide the source and sense connections. The function defines what type of analog signal the device uses. The range specifies the range for which the analog signal operates within. The scaling allows you to scale the analog signal into a given humidity value. For example, if you have an analog signal that ranges from 0 volts to 5 volts and it is known that 0 volts corresponds to 0% RH and 5 volts corresponds to 100%RH. You can then enter these scaling values and ControLog will automatically apply the scaling to the data item whenever it is displayed or logged.

< Back Next > Finish Cancel

Selecting the unit for the data item will allow ControLog to convert the value to the selected system units for display in the parameter tab and record the value in the default SI units in the data tab. Remember, this is the unit the device is sending the data item in, not the unit you wish to display the data item as. If “None” is selected, then ControLog will treat the data item as a simple number and will display and record the value exactly as it is received.

Connection Wizard

Data Item Name

Channel 101

Function Volts DC

Range 10 V

Enter a name or description of the data item and define the analog channel for it. The channel is the corresponding instrument channel that the device is connected to. For 4-wire measurements, the instrument automatically pairs channel n with channel n+10 to provide the source and sense connections. The function defines what type of analog signal the device uses. The range specifies the range for which the analog signal operates within. The scaling allows you to scale the analog signal into a given humidity value. For example, if you have an analog signal that ranges from 0 volts to 5 volts and it is known that 0 volts corresponds to 0% RH and 5 volts corresponds to 100%RH. You can then enter these scaling values and ControLog will automatically apply the scaling to the data item whenever it is displayed or logged.

Data Item Unit

Temperature °C

Temperature °F

Pressure °C

Enthalpy K

Density

FlowRate

None

Data Value

< Back Next > Finish Cancel

In addition to reading a temperature, ControLog can compute a percent relative humidity (%RH) at the temperature. This is useful when compensating for temperature gradients within the chamber. To have ControLog automatically calculate the relative humidity at the temperature, simply select the corresponding checkbox. The newly calculated %RH will have the same name as the specified Data Item Name but will be preceded by “%RH@”. In below example the calculated %RH will appear as “%RH@Temp Probe 1”.

Connection Wizard

Data Item Name: Temp Probe 1

Channel: 101

Function: Temperature RTD (4 Wire)

Range: 100 ohms, 91

Data Item Unit: Temperature °C

Also Calculate %RH at this Temperature

Scaling

Signal Value	Data Value

< Back **Next >** Finish Cancel

It is possible to scale an analog signal. The scaling consists of a two-point definition for a linear scaling or a three to five-point definition for polynomial fit scaling. The number of points determines the degree of the polynomial used to scale the analog signal. A Singular Value Decomposition (SVD) algorithm is used to determine the coefficients of the polynomial. Each point definition consists of a signal value and a data value. The signal value represents the “raw” analog signal. The data value represents the actual value or real-world value at the given signal value.

Scaling allows the user to scale an analog signal into a given humidity value. For example, if you have an analog signal that ranges from 0 volts to 5 volts and it is known that 0 volts corresponds to 0 %RH and 5 volts corresponds to 100 %RH. The user can then enter these scaling values and ControLog will automatically apply the scaling to the data item whenever it is displayed or logged.

Connection Wizard

Data Item Name **Channel** **Function** **Range**

Enter a name or description of the data item and define the analog channel for it. The channel is the corresponding instrument channel that the device is connected to. For 4-wire measurements, the instrument automatically pairs channel n with channel n+10 to provide the source and sense connections. The function defines what type of analog signal the device uses. The range specifies the range for which the analog signal operates within. The scaling allows you to scale the analog signal into a given humidity value. For example, if you have an analog signal that ranges from 0 volts to 5 volts and it is known that 0 volts corresponds to 0% RH and 5 volts corresponds to 100%RH. You can then enter these scaling values and ControLog will automatically apply the scaling to the data item whenever it is displayed or logged.

Data Item Unit

Scaling

Signal Value	Data Value
0	0
5	100

< Back **Next >** Finish Cancel

Select the name and location to save the new analog connection. Clicking the “Browse” button will open a save file dialog that will allow the user to specify the name and browse to the desired location to save the file. All device connection files are saved in XML format with a (*.device) extension.

Connection Wizard

Save Device Configuration as

Select the name and location to save this device configuration to.

< Back **Next >** Finish Cancel

Next, the user can select whether to connect to the device now or to exit without connecting.

Note - *The user can connect at any time by loading the device from the Connections menu.*



Select the communication port that the Agilent® 34970A Data Acquisition/Switch Unit is connected to and select the port settings for the 34970A.

Note - *ControLog defaults to the default port settings for the Agilent® 34970A Data Acquisition/Switch Unit. Refer to the Agilent® documentation for instructions on viewing or setting the Data Acquisition RS-232 settings.*

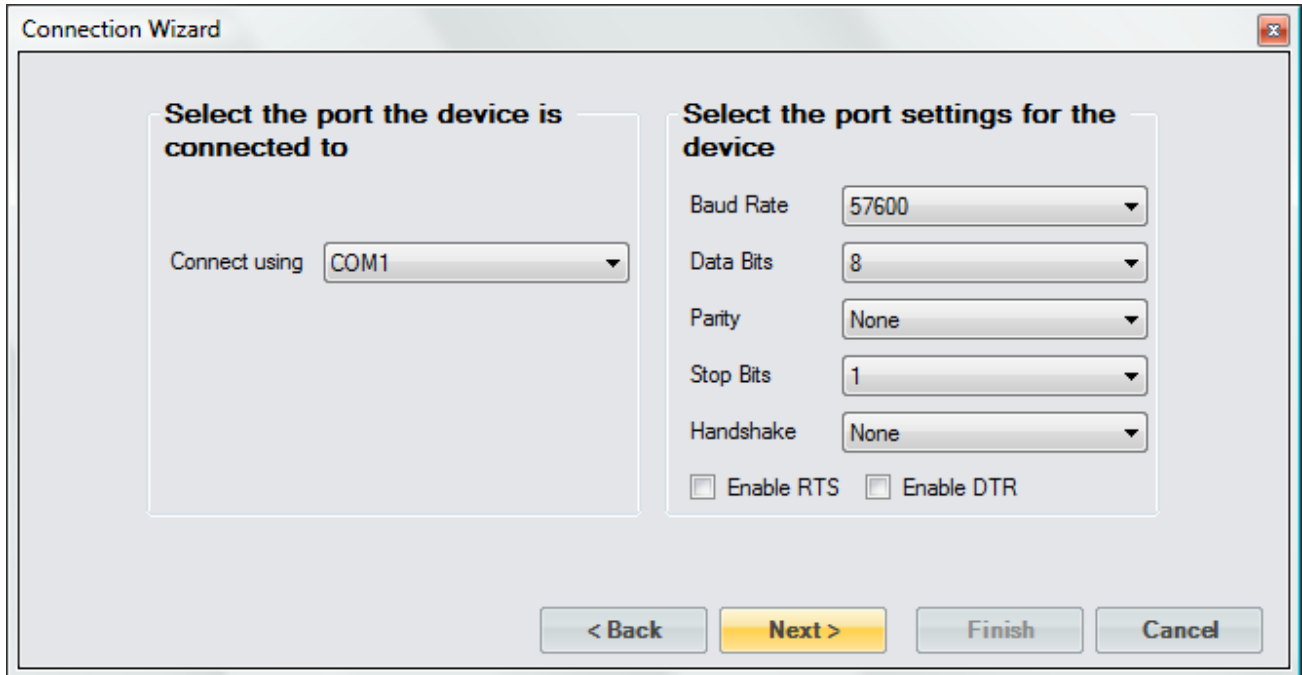

Connection Wizard

Select the port the device is connected to

Connect using

Select the port settings for the device

Baud Rate

Data Bits

Parity

Stop Bits

Handshake

Enable RTS Enable DTR

< Back Next > Finish Cancel

Select the access rate to communicate with the Agilent® 34970A Data Acquisition/Switch Unit.

Note - Because of the nature of the 34970A and how it operates it is critical to specify an access interval that is long enough to allow the 34970A to complete its scan list within the specified interval. As a general rule of thumb, use 1.5 seconds per every 10 signals connected to the Data Acquisition Unit with a minimum access interval of 1.5 seconds.



10.2.1 Analog Connection Example

This example will demonstrate the creation of an analog connection. This example will be working with a -10 to +10V input signal that we will scale to a Dew Point/Frost Point Temperature, a Temperature Thermistor and a 4-wire Temperature RTD.

Start by selecting “New” from the Connections menu.

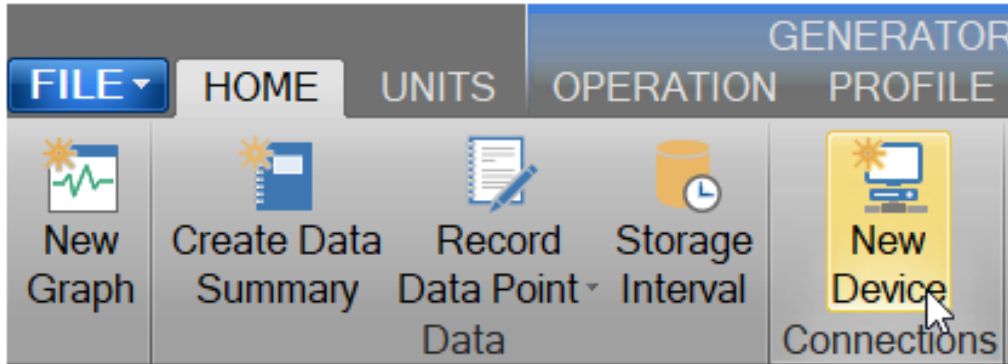

Select “Analog” as the type of device connection.

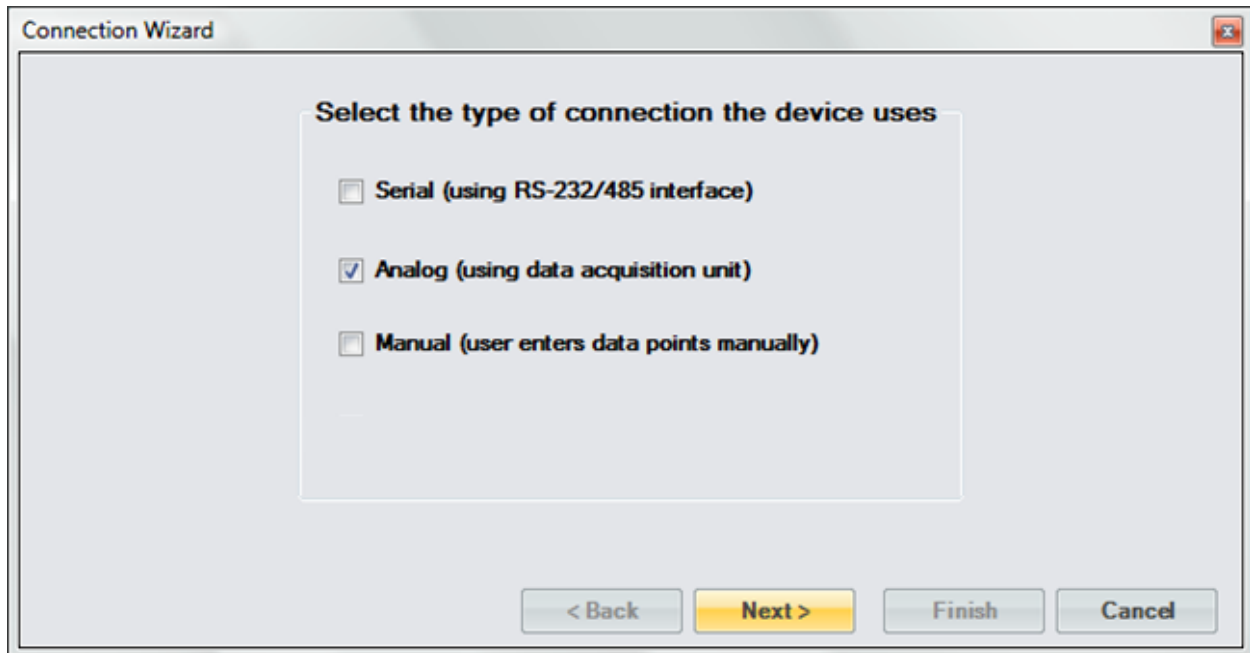

Enter "Analog Dew Point Device" as the name for the device.

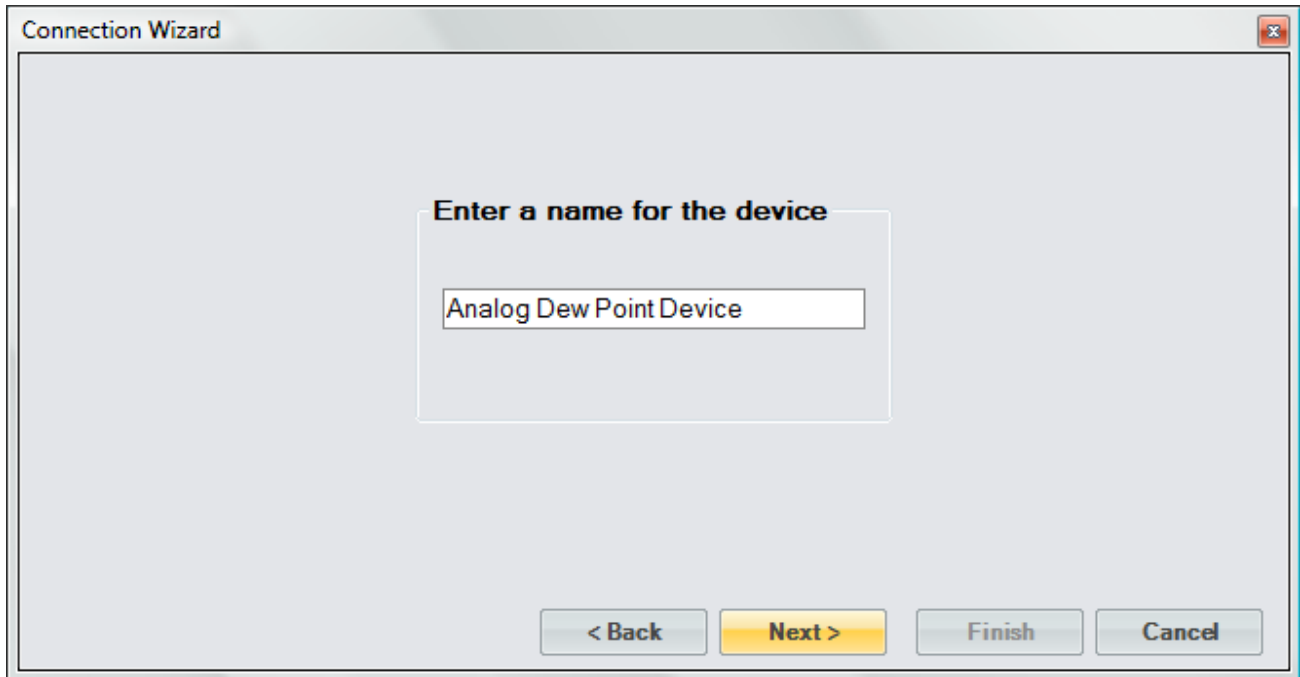

In this example we have three signals that we want to monitor; a voltage, thermistor and an RTD.

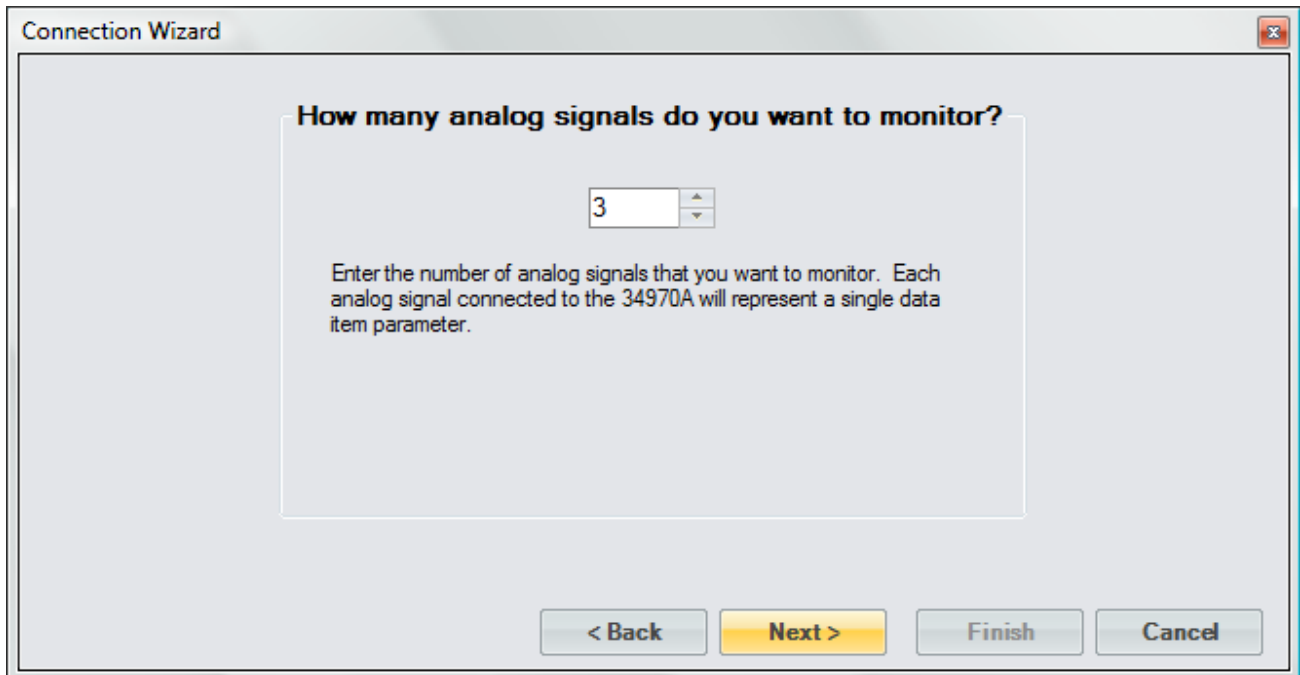

The first item is given the name “Dew/Frost Point”. We select the Channel number that the signal is connected to and since the signal is a voltage we select “Volts DC” as the function. The range is set to “10V” and we know the signal corresponds to a temperature in degrees Celsius. We also scale the value since we know -10V corresponds to a Frost Point temperature of -100 °C and +10V corresponds to a Dew Point temperature of +100 °C. By entering scaling ControLog will automatically scale the signal for display in the parameter tab and when recorded in the data tab.

Connection Wizard

Data Item Name **Channel** **Function** **Range**

Data Item Unit

Also Calculate %RH at this Temperature

Scaling

Signal Value	Data Value
-10	-100
10	100

Enter a name or description of the data item and define the analog channel for it. The channel is the corresponding instrument channel that the device is connected to. For 4-wire measurements, the instrument automatically pairs channel n with channel n+10 to provide the source and sense connections. The function defines what type of analog signal the device uses. The range specifies the range for which the analog signal operates within. The scaling allows you to scale the analog signal into a given humidity value. For example, if you have an analog signal that ranges from 0 volts to 5 volts and it is known that 0 volts corresponds to 0% RH and 5 volts corresponds to 100%RH. You can then enter these scaling values and ControLog will automatically apply the scaling to the data item whenever it is displayed or logged.

The second item is given the name “Temperature 1”. We select the Channel number that the signal is connected to. Notice ControLog indicates which channels have already been configured and are in use.

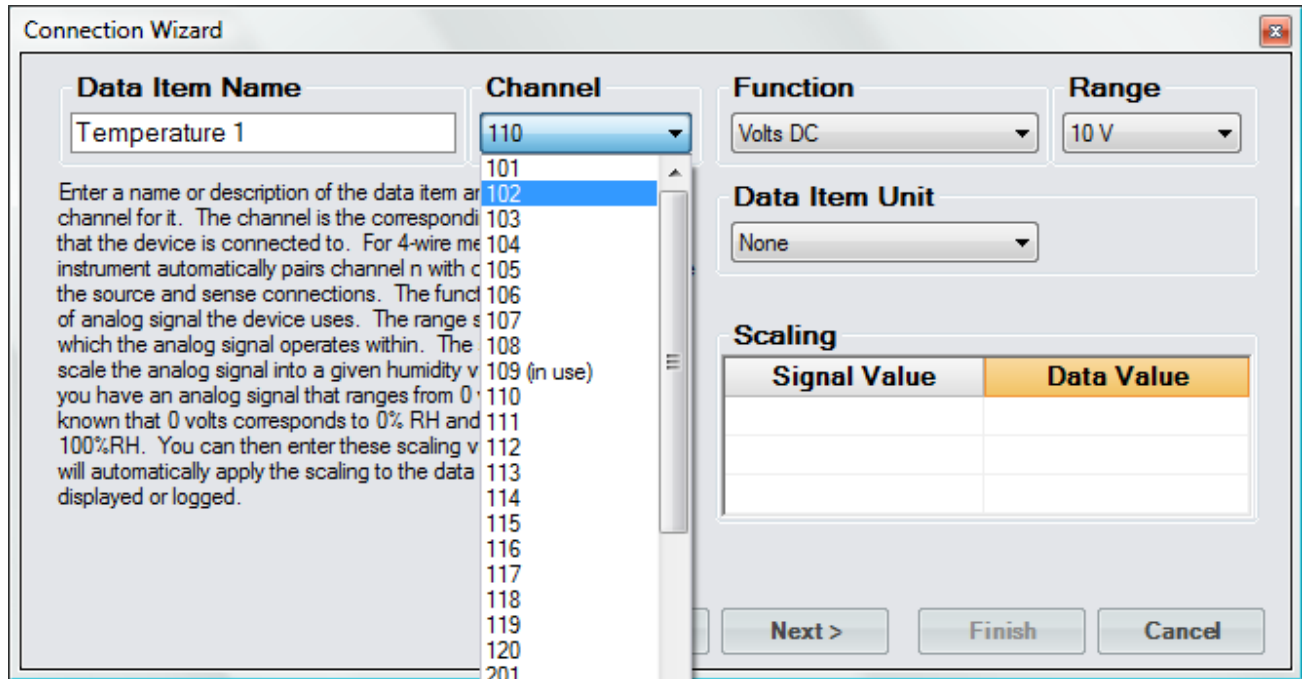

The function is set to “Temperature Thermistor” and we set the Range to “10k” based on the type of Thermistor we are connecting. Notice that ControLog automatically selects temperature as the unit type but allows the user to select the desired temperature unit. Since the signal value is the actual temperature value, no scaling is required for this data item.

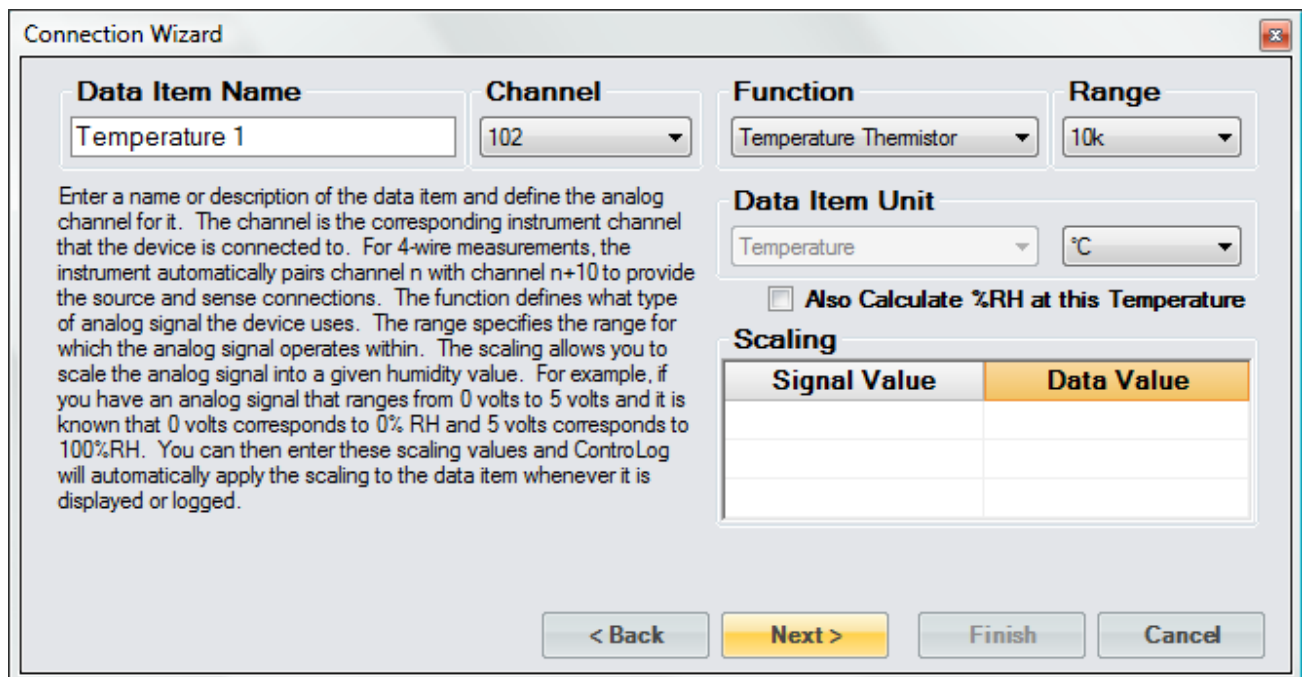

The third item is given the name “Temperature 2”. The function is set to “Temperature RTD (4 Wire)” and we set the Range to “100 ohms, 85” based on the type of RTD we connected. Next, select the Channel number the RTD is connected to. Notice the channel list is smaller because 4-wire signals are automatically paired with the selected channel plus 10 to provide the source and sense connections for an RTD. Given this, the RTD in this example will occupy both channel 110 and 120 to complete its 4-wire connection.

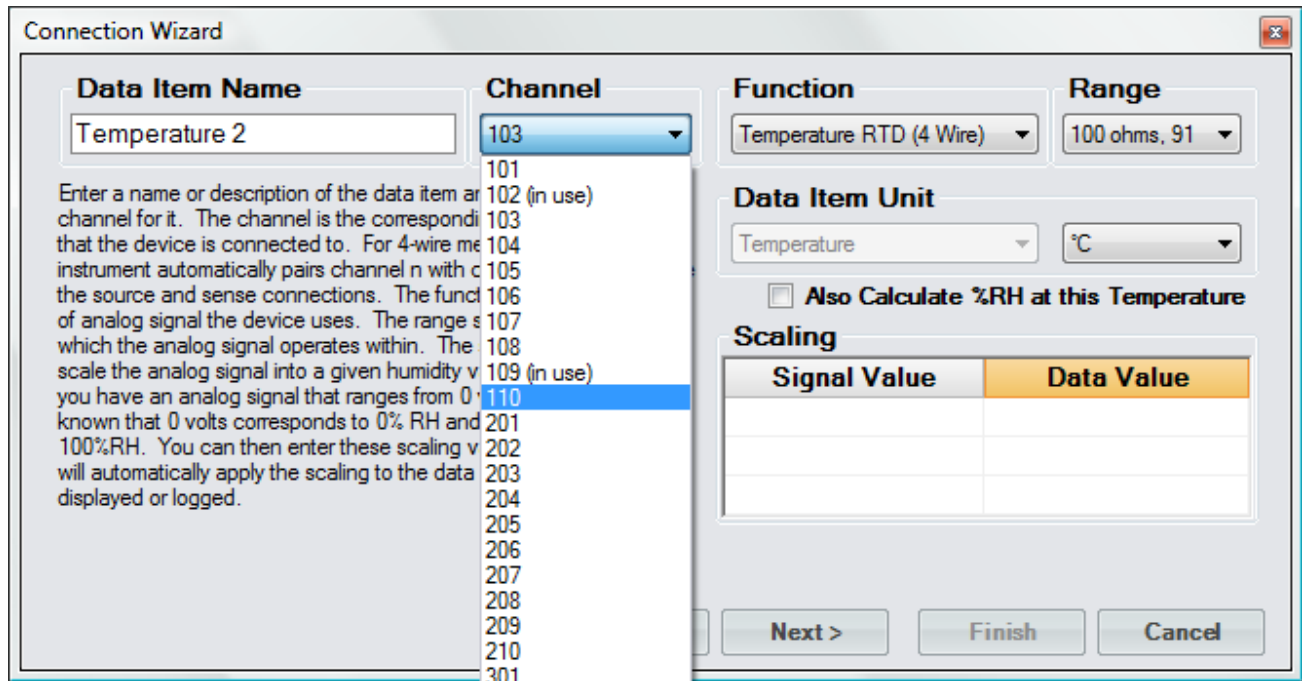

Again, notice that ControLog automatically selects temperature as the unit type but allows the user to select the desired temperature unit. Since the signal value is the actual temperature value, no scaling is required for this data item.

Connection Wizard

Data Item Name: Temperature 2

Channel: 110

Function: Temperature RTD (4 Wire)

Range: 100 ohms, 91

Enter a name or description of the data item and define the analog channel for it. The channel is the corresponding instrument channel that the device is connected to. For 4-wire measurements, the instrument automatically pairs channel n with channel n+10 to provide the source and sense connections. The function defines what type of analog signal the device uses. The range specifies the range for which the analog signal operates within. The scaling allows you to scale the analog signal into a given humidity value. For example, if you have an analog signal that ranges from 0 volts to 5 volts and it is known that 0 volts corresponds to 0% RH and 5 volts corresponds to 100%RH. You can then enter these scaling values and ControLog will automatically apply the scaling to the data item whenever it is displayed or logged.

Data Item Unit: Temperature °C

Also Calculate %RH at this Temperature

Scaling

Signal Value	Data Value

< Back Next > Finish Cancel

Save the newly created device to a file so it can be recalled at a later time.

Connection Wizard

Save Device Configuration as

Analog Dew Point Device Browse

Select the name and location to save this device configuration to.

< Back Next > Finish Cancel

Select to connect to the device now.



Select the communication port that the Agilent® 34970A Data Acquisition/Switch Unit is connected to and select the port settings for the 34970A.

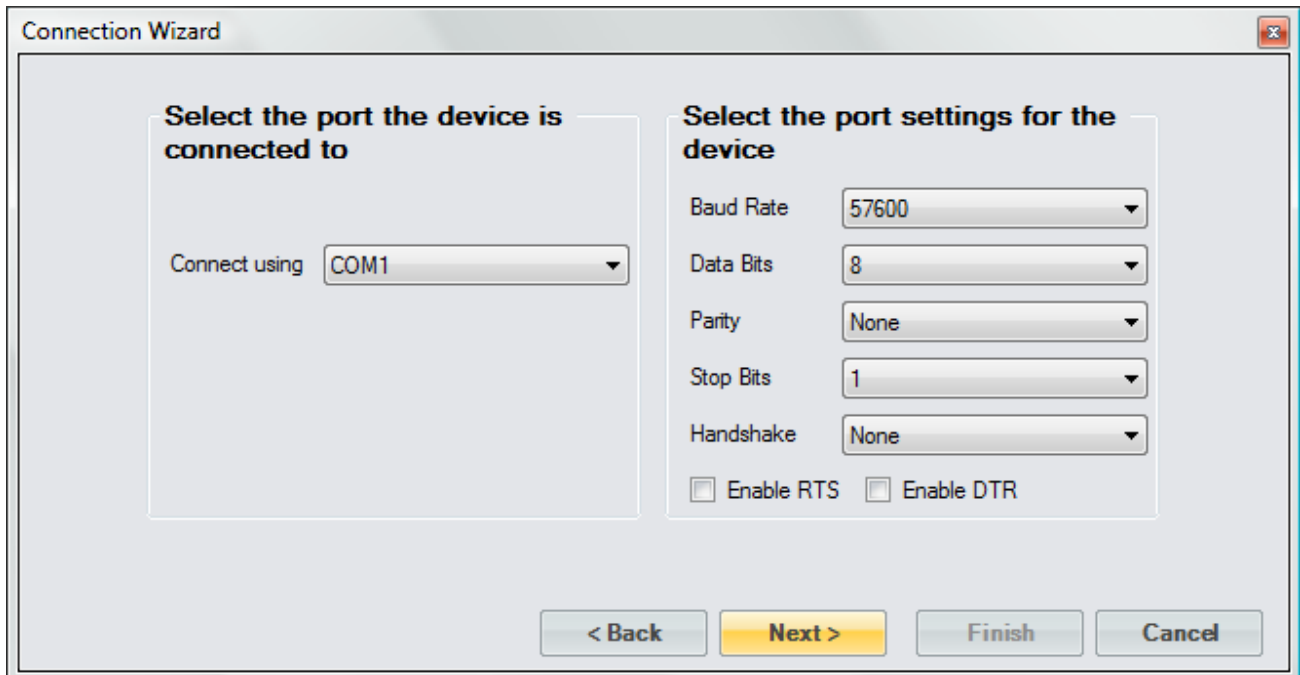

Enter a sufficient access interval for the number of signals being monitored. In this example we have less than 10 signals, so we can start with the minimum access interval of 1.5 seconds.



Once completed, ControLog will attempt to establish communication with the Agilent® 34970A Data Acquisition/Switch Unit.

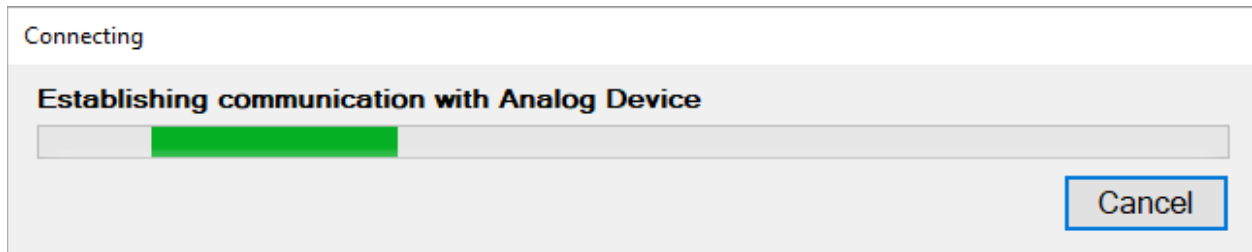

Once communication is successfully established with the 34970A, a new parameter tab and data tab will be created. Notice that ControLog automatically scales the voltage signal based on the definitions described when defining the data item.

The screenshot shows the 2900 ControLog interface with the following components:

- Menu Bar:** FILE, HOME, OPERATION, PROFILE, UTILITIES, SETTINGS, DATA. The 'SELECTION' tab is active.
- Toolbar:** New Device, Settings, Disconnect, Interface, Console.
- Analog Dew Point Device Parameters:**
 - Temperature 1: 26.413 C
 - Dew/Frost Point: 12.396 C
 - Temperature 2: 26.161 C
- Analog Dew Point Device Data Table:**

Date/Time Stamp	Temperature 1 [C]
11/14/2017 14:15:40	26.486
11/14/2017 14:16:10	26.468
	26.449
	26.429
- Status Log:**
 - 11/14/2017 2:14:10 PM: Generate Mode Enabled
 - 11/14/2017 2:14:10 PM: Filling Pre-Saturator
 - 11/14/2017 2:14:11 PM: Communication established with the 2900 generator (S/N 0000000)
 - 11/14/2017 2:15:27 PM: Communication established with the Analog Dew Point Device device
- Bottom Bar:** 2900 Parameters, Analog Dew Point Dev..., Status Log. A status indicator shows 'System is generating'.

10.3 MANUAL CONNECTION

A Manual Connection allows the user to manually record data items for a device that either has no interface or has an interface that is not supported by ControLog. Manual devices still have their own parameter and data tab, but the data values are manually entered by the user. When the user wants to record values they simply click on the value tile for the data item in the parameter tab and enter the value. Once all data items for the device have been entered, ControLog will record the values into the data tab for the device.

To create a manual connection, select “New” from the Connections menu. This will open a “Connection Wizard” dialog that will step the user through the connection definition process.

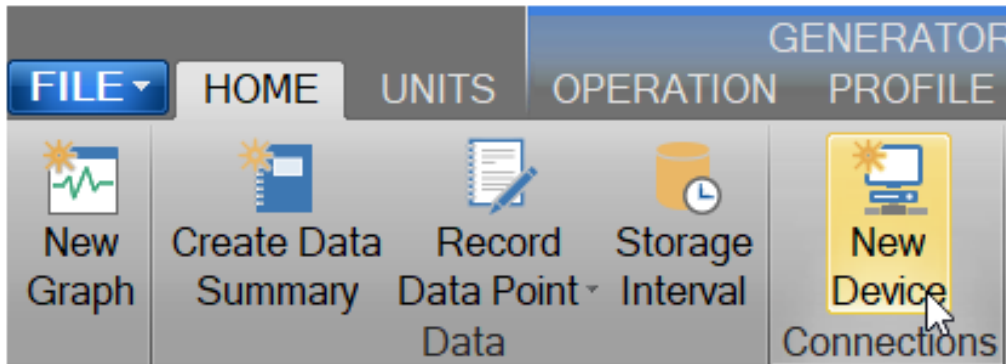

Select “Manual” as the type of connection the device uses.

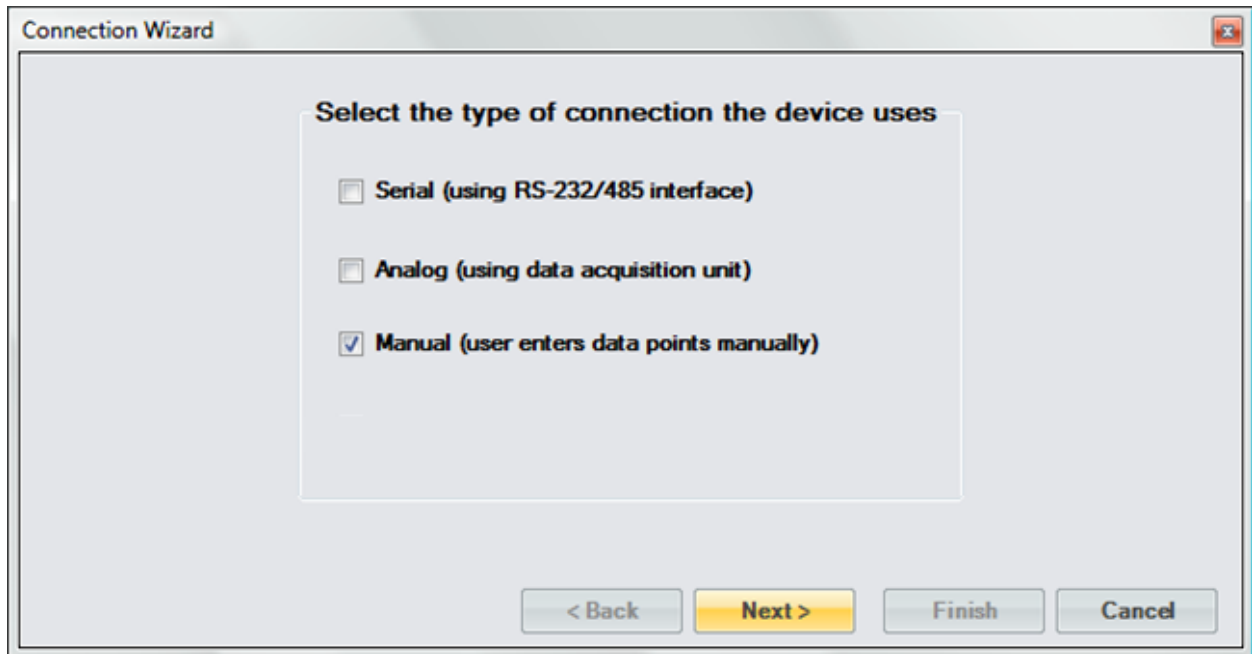

Enter a unique name for the device.



The screenshot shows a window titled "Connection Wizard" with a close button in the top right corner. The main area contains the text "Enter a name for the device" above a single-line text input field. At the bottom, there are four buttons: "< Back", "Next >" (highlighted in yellow), "Finish", and "Cancel".

Select the number of manual data entries.

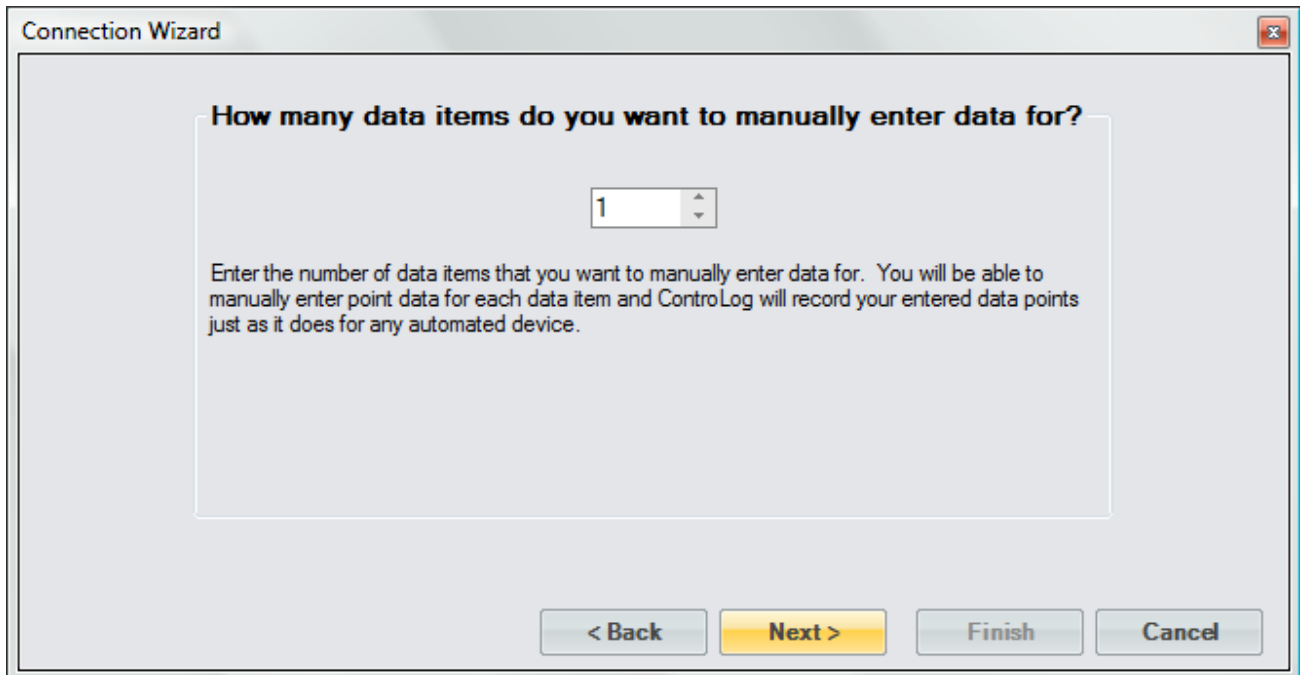

The screenshot shows a window titled "Connection Wizard" with a close button in the top right corner. The main area contains the text "How many data items do you want to manually enter data for?" above a spin box containing the number "1". Below the spin box is a paragraph of text: "Enter the number of data items that you want to manually enter data for. You will be able to manually enter point data for each data item and ControlLog will record your entered data points just as it does for any automated device." At the bottom, there are four buttons: "< Back", "Next >" (highlighted in yellow), "Finish", and "Cancel".

Enter a name or description of the manual device data item and specify the type of unit that you will be entering the data in.

Connection Wizard

Data Item Name

Data Item Unit
None

Enter a name or description of the manual device data item and specify the type of unit that you will be entering the data in.

< Back Next > Finish Cancel

The user only selects the type of unit because all manual entries are entered in the currently selected system unit. For example, if the user creates a manual data item that is a temperature and has the system units set to degrees Celsius, then the user will enter manual values in degrees Celsius. If the system units are set to degrees Fahrenheit, then the user will be required to enter manual values in degrees Fahrenheit.

Connection Wizard

Data Item Name

Data Item Unit
None
Temperature
Pressure
Enthalpy
Density
FlowRate
None

Enter a name or description of the manual device data item and specify the type of unit that you will be entering the data in.

< Back Next > Finish Cancel

Select the name and location to save the new manual connection. Clicking the “Browse” button will open a save file dialog that will allow the user to specify the name and browse to the desired location to save the file. All device connection files are saved in XML format with a (*.device) extension.



Last, the user selects whether to connect to the device now or to exit without connecting.

Note - *The user can connect at any time by loading the device from the Connections menu.*



10.3.1 Manual Connection Example

This example will demonstrate the creation of a Manual connection that will consist of three data items: Frost Point, Test Pressure and Test Temperature.

Start by selecting “New” from the Connections menu.

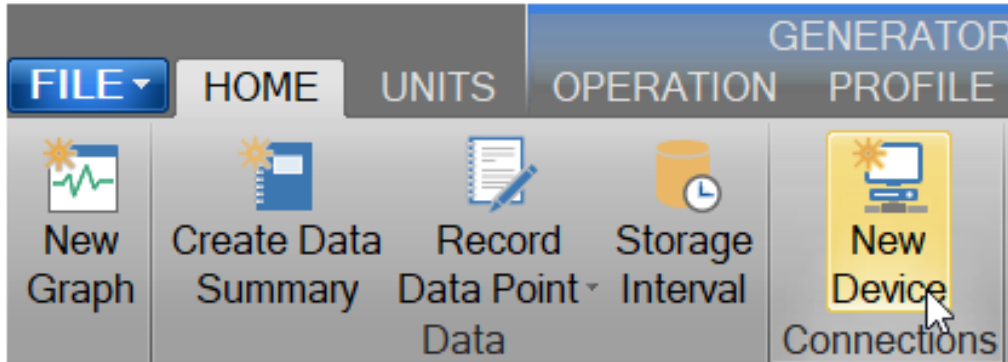

Select “Manual” as the type of connection the device uses.

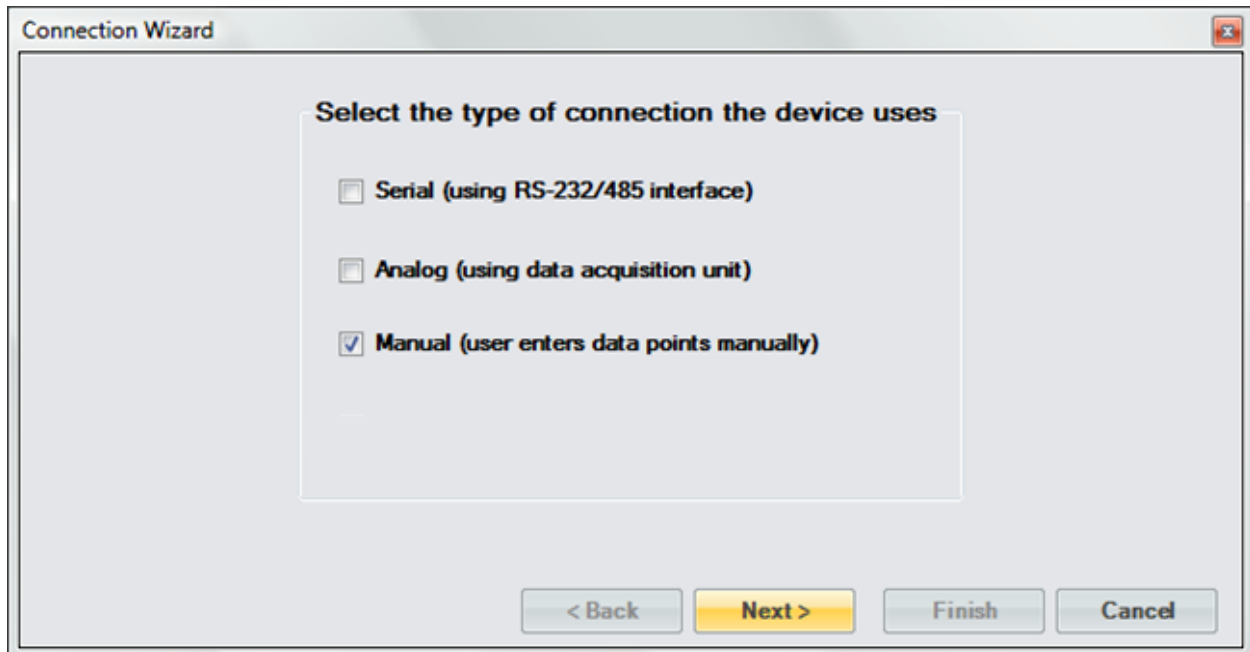

Enter "Manual Device" as the name for the device.



We have three data items that we want to manually enter for this device.

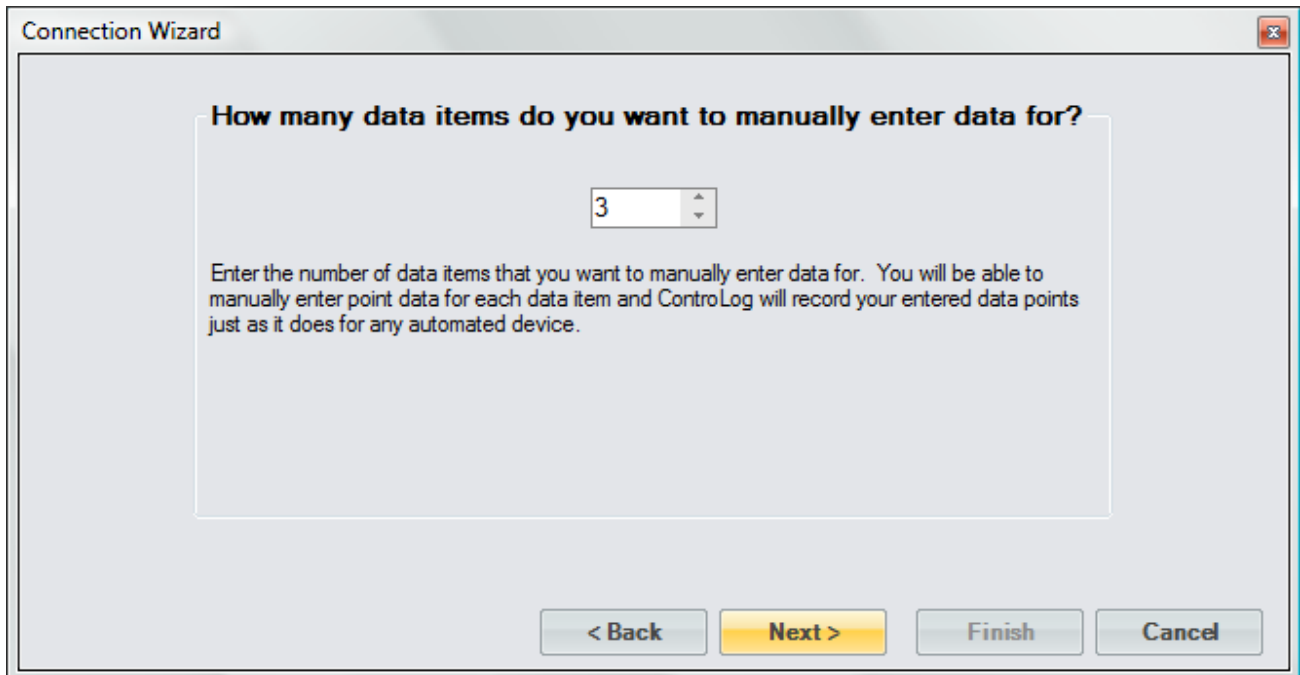

The first point is Frost Point and it will be of the temperature unit type.

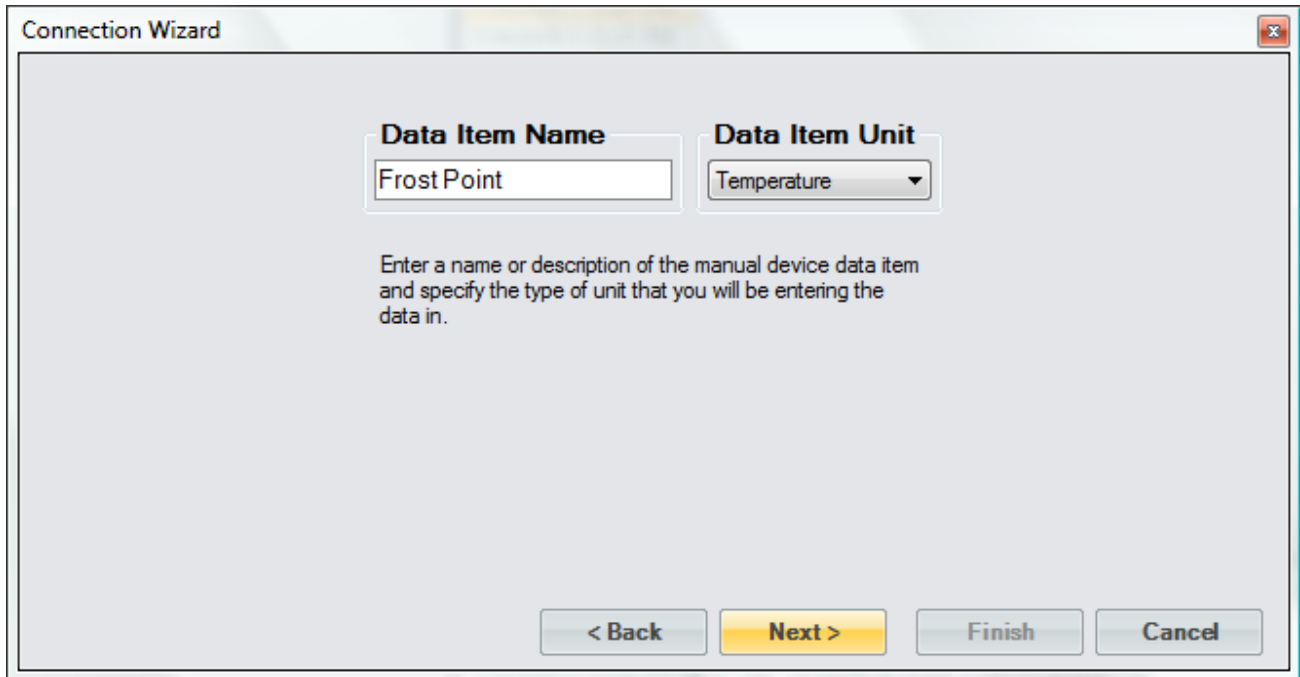

The screenshot shows a window titled "Connection Wizard" with a close button in the top right corner. Inside the window, there are two input fields: "Data Item Name" containing the text "Frost Point" and "Data Item Unit" which is a dropdown menu currently showing "Temperature". Below these fields is a text instruction: "Enter a name or description of the manual device data item and specify the type of unit that you will be entering the data in." At the bottom of the window, there are four buttons: "< Back", "Next >" (highlighted in yellow), "Finish", and "Cancel".

The second point is Test Pressure and it will be of the pressure unit type.

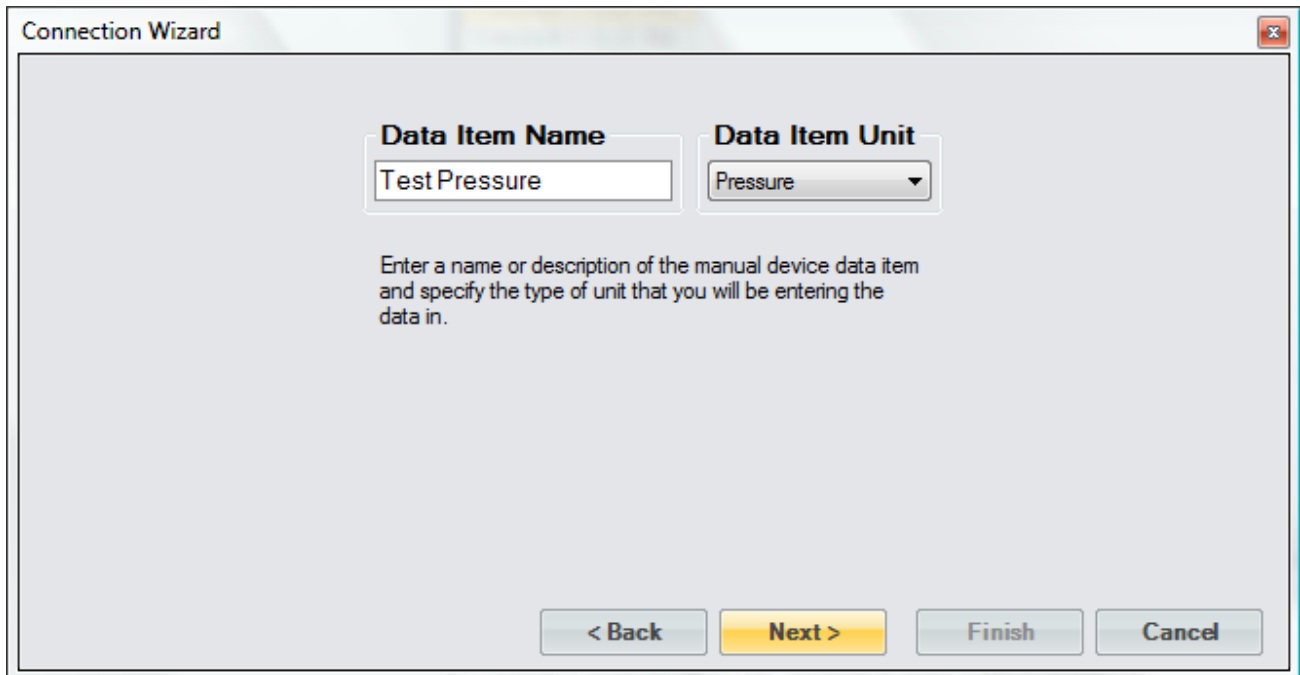

The screenshot shows a window titled "Connection Wizard" with a close button in the top right corner. Inside the window, there are two input fields: "Data Item Name" containing the text "Test Pressure" and "Data Item Unit" which is a dropdown menu currently showing "Pressure". Below these fields is a text instruction: "Enter a name or description of the manual device data item and specify the type of unit that you will be entering the data in." At the bottom of the window, there are four buttons: "< Back", "Next >" (highlighted in yellow), "Finish", and "Cancel".

The third point is Test Temperature and it will be of the temperature unit type.

The screenshot shows a window titled "Connection Wizard" with a close button in the top right corner. The main area contains two input fields: "Data Item Name" with the text "Test Temperature" and "Data Item Unit" with a dropdown menu showing "Temperature". Below these fields is the instruction: "Enter a name or description of the manual device data item and specify the type of unit that you will be entering the data in." At the bottom, there are four buttons: "< Back", "Next >" (highlighted in yellow), "Finish", and "Cancel".

Save the newly created device to a file so that it can be recalled at a later time.

The screenshot shows a window titled "Connection Wizard" with a close button in the top right corner. The main area contains a text input field with "Manual Device" and a "Browse" button. Below this is the instruction: "Select the name and location to save this device configuration to." At the bottom, there are four buttons: "< Back", "Next >" (highlighted in yellow), "Finish", and "Cancel".

Select to connect to the device now.



Once completed, a new parameter tab and data tab will be created.

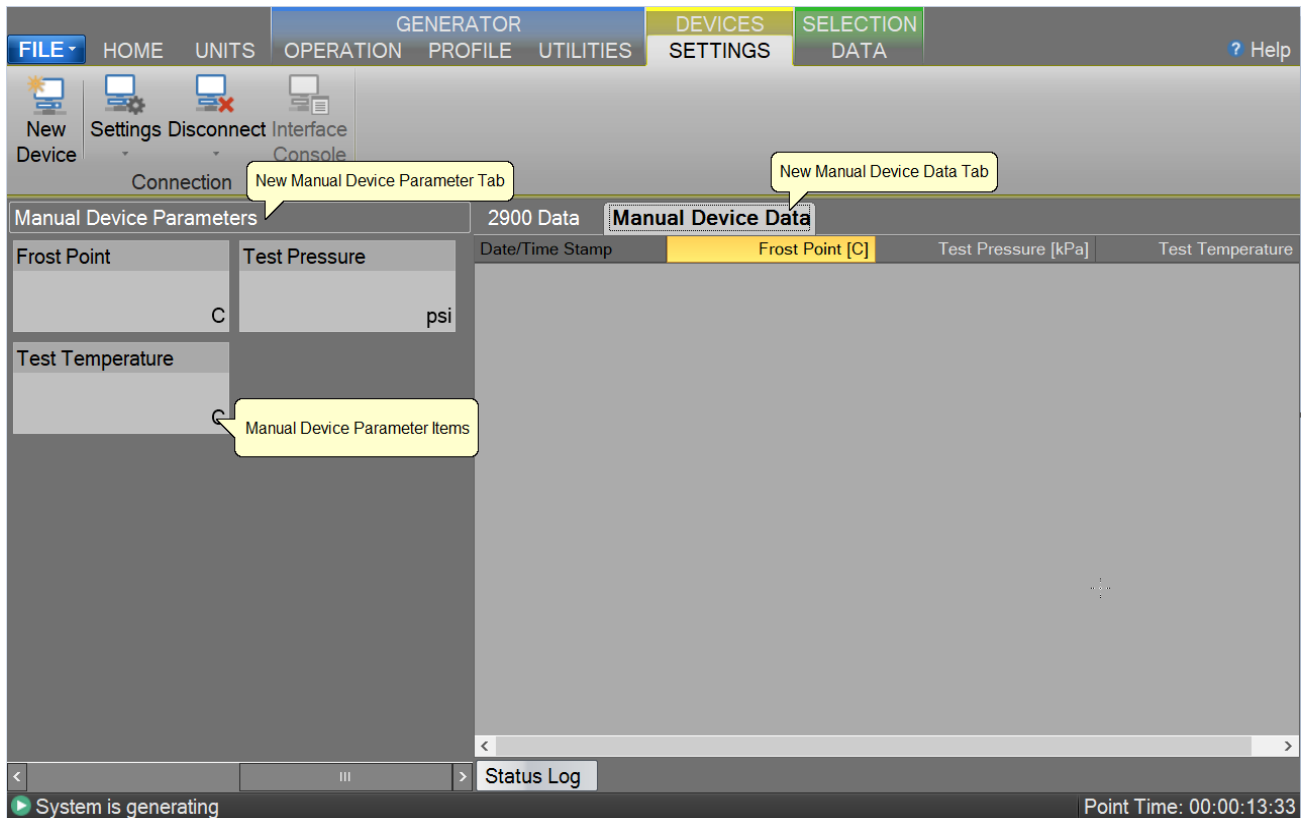

To manually enter a value, click on the value tile you would like to enter. A Manual Entry box will appear, and the title of the manual item being entered will be underlined. For example, to enter a manual value for the Frost Point item click on the Frost Point value tile.

Note - The manual entries will not be recorded in the data tab until all data item values have been manually entered.

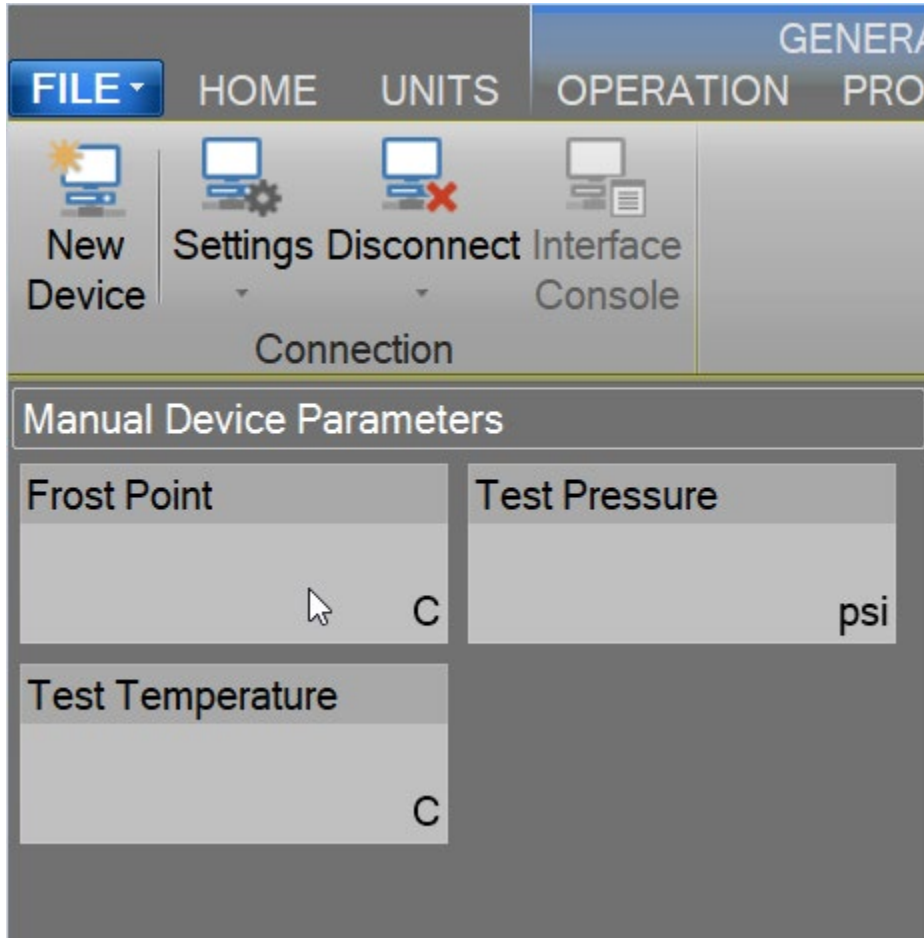

Enter the manual value into the Manual Entry box and select Ok.

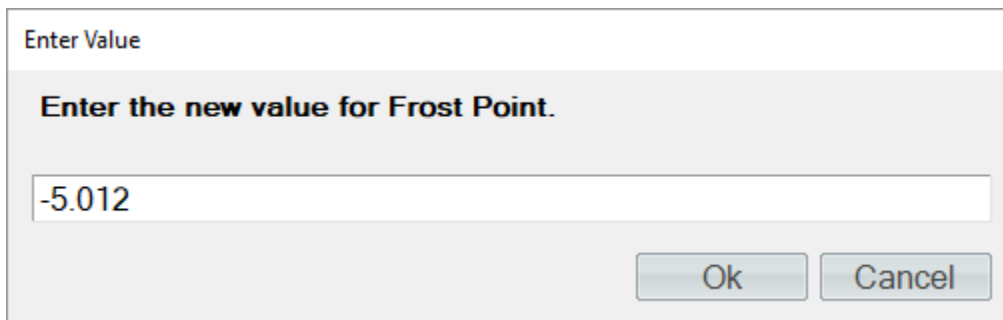

The manual entry will now be displayed in the value tile of the parameter tab.

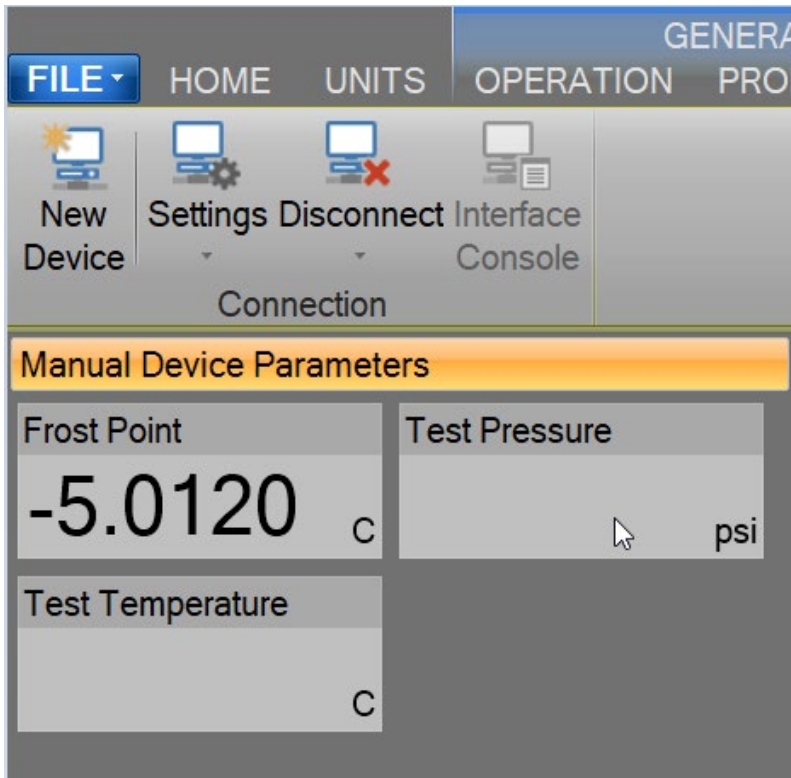

Repeat the process for the remaining data items.

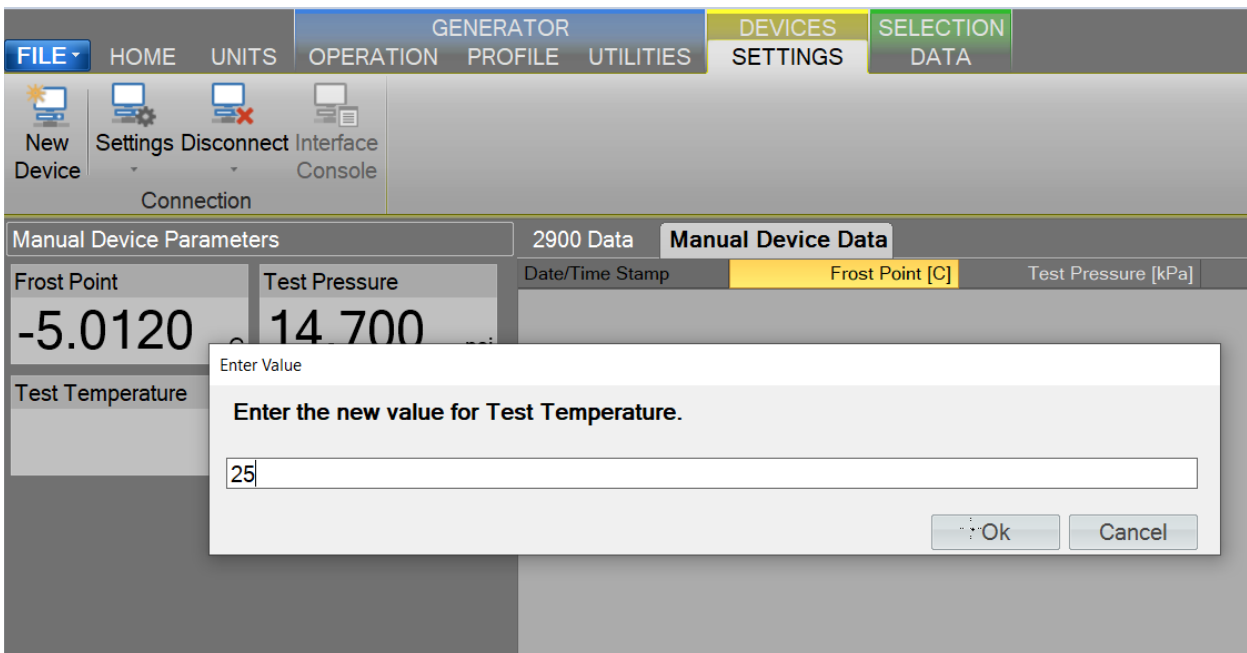

Once all data items have been manually entered, ControLog will record the values and clear out the value tiles in preparation for the next set of manual entries.

The screenshot displays the ControLog software interface. At the top, there is a navigation menu with tabs for 'GENERATOR OPERATION PROFILE UTILITIES', 'DEVICES SETTINGS', and 'SELECTION DATA'. Below the menu, there are icons for 'New Device', 'Settings Connection', 'Disconnect', and 'Interface Console'. The main area is divided into 'Manual Device Parameters' and '2900 Data Manual Device Data'. The 'Manual Device Parameters' section includes input fields for 'Frost Point' (unit: C), 'Test Pressure' (unit: psi), and 'Test Temperature' (unit: C). A callout box labeled 'Cleared Value Tiles' points to the 'Test Temperature' field. The '2900 Data Manual Device Data' section shows a table with the following data:

Date/Time Stamp	Frost Point [C]	Test Pressure [kPa]
9/25/2019 14:29:31	-5.012	101.3529322

A callout box labeled 'Recorded manual entries' points to the data row in the table.

10.4 OPENING A DEVICE CONNECTION

Saved device connections can be loaded from previously saved device configuration files.

To perform the open, select “Open” from the file menu and select Device Configuration.

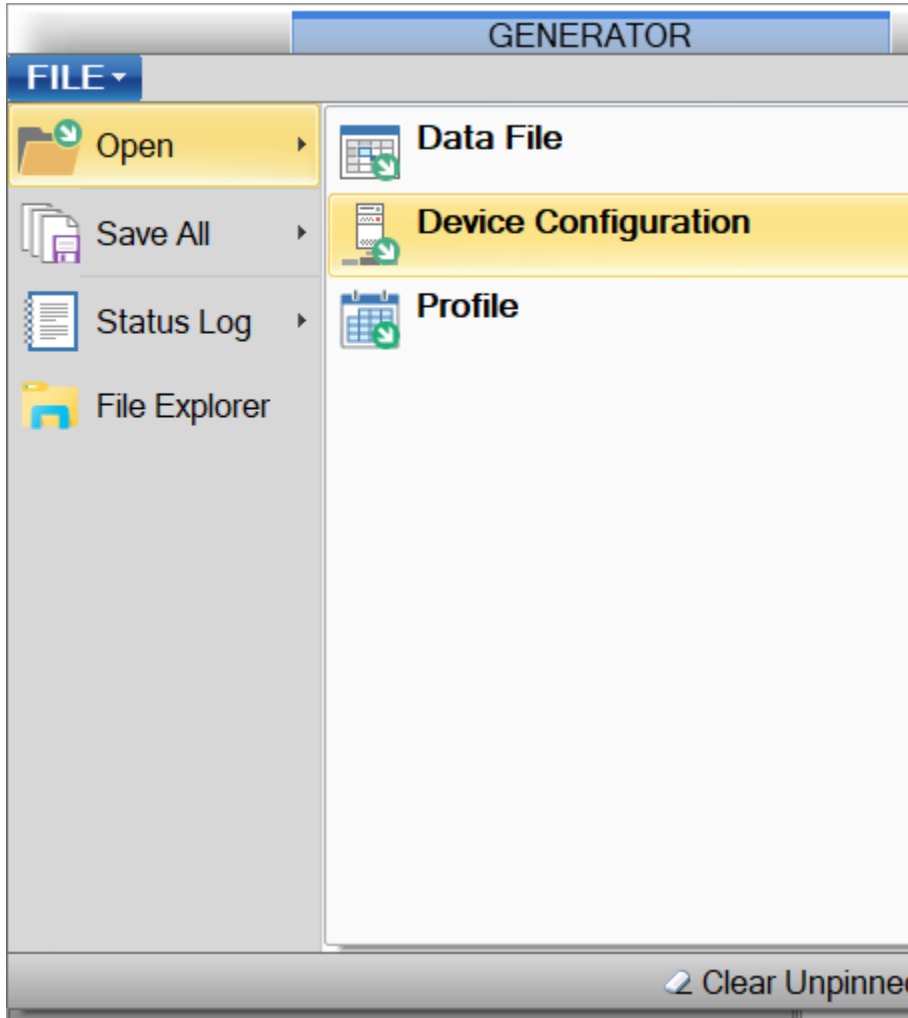

11 DATA BACKUP

ControLog does not require any direct backup of its operating files. It is recommended to perform a periodic backup on any user generated files such as uncertainty solutions for the generator, profiles, device setups data files and/or calibration reports or coefficients.

The default location for user data is under the follow directory:

...Documents\Thunder Scientific

Note - *The user has full control as to where to save data and the above directory may not be the location they choose.*

12 SYSTEM

The System is comprised of several sub systems, each with individual yet cooperative functions that operate the Model 2900 Humidity Generation System.

12.1 CONTROL SYSTEM

The Control System performs all control functions required for humidity generation. The control system is made up of several main components, each with individual yet cooperative functions. The control computer controls the parameters needed to generate humidity, such as pulsing heaters and operating valves. The Human Machine Interface (HMI) Computer is the main interface for the user and communicates setpoints and data to and from the control computer.

12.1.1 Control Computer

The Control computer is an NI cDAQ-9136 controller built around an Intel Atom quad-core processing and 32 GB nonvolatile storage for advanced data-logging and embedded monitoring applications. The controller runs Windows Embedded Standard 7 (WES7) and offers a wide array of standard connectivity and expansion options, including SD storage, USB, Ethernet, RS232 serial, and trigger input. The NI cDAQ-9136 has four 32-bit general-purpose counter/timers that are used with the hardware-timed digital modules.

12.1.1.1 NI 9216 24-Bit, 100 Ohm RTD Analog Input Module

The NI 9216 resistance temperature detector (RTD) analog input module features eight channels and 24 bits of resolution for PT100 Ω RTD measurements with built-in 50/60 Hz noise rejection. The NI 9216, compatible with 3- and 4-wire RTD measurements, automatically detects the type of RTD (3- or 4-wire) connected to the channel and configures each channel for the appropriate mode. The module provides 1 mA of current excitation per channel.

12.1.1.2 NI 9209 ± 10 V, 24-Bit Analog Input Module

The NI 9209 voltage input module has 16 differential channels of ± 10 V that can be configured as 32 single-ended channels of ± 10 V input with built-in 50/60 Hz rejection for noise rejection.

12.1.1.3 NI 9403 TTL Digital Input/Output Module

The NI 9403 is a 32-channel, 7 μ s bidirectional digital I/O module. Each channel is compatible with 5 V/TTL signals and features 1,000 Vrms transient isolation between the I/O channels and the backplane. The NI 9403 also features ± 30 V overvoltage protection and can source up to 2 mA output current per channel.

12.1.1.4 NI 9401 TTL Digital Input/Output Module

The NI 9401 is an 8-channel, 100 ns bidirectional digital I/O module. The NI 9401 generates 4 separate hardware timed pulse width modulation (PWM) signals. Each channel is compatible with 5 V/TTL signals and features 1,000 Vrms transient isolation between the I/O channels and the backplane.

12.1.2 HMI Computer

The Human Machine Interface (HMI) computer is an embedded PC with a Multi-Point Touch LCD display. It provides the main two user interface components; visual and touch. The visual component provides the operator with a rich data experience, including real-time data values, graphs, uncertainty and status. The touch component provides the operator with an intuitive interface to control the operation of the system. The HMI computer runs the ControLog and HumiCalc with Uncertainty software applications.

12.1.3 ControLog® Software

ControLog is an embedded software application that fully automates the operation of the Model 2900 Humidity Generation System and allows various device connections through a number of different interfaces. Data from the generator and attached devices is automatically retrieved and stored for viewing in either numerical or graphical format in real time or post process. Data can be transferred off the system via a USB drive for further viewing, post processing and printing using an external Windows PC (not included). The ControLog software also provides the primary interface to the operator via the multi-point touch LCD and keyboard. Key features of the of the ControLog software are:

- ControLog stores data into individual data sheets. Each data sheet contains a spreadsheet type view that consists of a date/time stamp and the measured data items corresponding to that date/time stamp. Data sheets consist of three similar but different types: Device Data, File Data and Data Summary. Each type has the same spreadsheet type view and operation, but all three have different data sources.
- Graphing is a powerful tool used to view previously recorded data or to monitor the current data in real-time. The graph works hand in hand with the data sheets. While the generator is in operation, data sheets store the most recent data points from the generator and or connected devices at the desired interval. A graph can be used to create a visual picture of this stored data.
- The Auto Profiling feature is very similar to the Generate mode with the main exception that profiling relies on a predefined list of setpoints referred to as a profile. The user configurable profile is used as ControLog's road map during Auto Profile operation. It defines which setpoint values to go to, at what rate to go from one setpoint to another, and how long to stay at a specific setpoint before moving to the next setpoint.
- ControLog supports a customizable interface that works with most devices. ControLog will allow the user to create a new device connection using the "Connection Wizard" or open previously saved connections. The wizard will open a separate dialog window containing various steps that will guide the user in defining the communication required to receive the desired data items from the device. The user can create as many (up to 60) or as few data items as they see fit for any one device. Each data item can be uniquely named and once connected will be recorded in its own data sheet. ControLog also allows the user to save these interfaces for future use. The "Connection Wizard" allows the user to step through the connection configuration. Using the "Next" and "Back" buttons the user is allowed to progress through the connection configuration steps. At any time, the user may cancel the new

connection or opening of a connection by selecting the “Cancel” button. Once the last step has been completed the “Finish” button will be available to complete the new connection.

12.1.4 HumiCalc with Uncertainty[®] Software

HumiCalc with Uncertainty is an embedded software application that operates in conjunction with ControLog. All humidity calculations, based on the temperature and pressure measurements from the generator, are calculated in real-time using HumiCalc with Uncertainty. This does not stop at calculations as HumiCalc with Uncertainty has the ability to calculate complex humidity uncertainties with ease. This allows the software to calculate real-time uncertainty for the 2900 Humidity Generation System. Key features of the HumiCalc with Uncertainty software are:

Highly accurate formulas that replace charts and tables:

- Automatically applies enhancement factors and temperature and pressure corrections.
- Ability to calculate uncertainty and as found error.
- Each known item now contains an uncertainty field that you can expand to enter individual uncertainty components.

Once the calculation is performed, the newly calculated values are displayed along with the expanded uncertainty values at the desired confidence level. Each calculated result can also be expanded to see the individual components that made up the final expanded uncertainty value.

12.2 ELECTRICAL SYSTEM

Power is applied at the Power Entry Module (PEM) and switched to TB-1. From TB-1 power is applied to the +12 Vdc (DC1) and +24 Vdc (DC2) power supplies and solid-state relays SSR-AC0 (chamber fluid heater H1), SSR-AC1 (pre-saturator heater H2,3), SSR-AC2 (refrigeration compressor C1), and SSR-AC3 (fluid pump FP1). These solid-state relays are activated by +5 Vdc control signals which will be discussed later.

The +12Vdc power supply (DC1) provides power to the human machine interface computer (HMI), control computer, MOXA serial ports, Mensor pressure transducers, mass flow transducer and supply transducer.

The +24 Vdc power supply (DC2) provides power for the stepper motors, solenoid valves, expansion valve heat, refrigeration condenser fans (FAN1) and chamber fan (FAN2).

The +5 Vdc power supply (DC3) provides power to the liquid level circuits, refrigeration transducers, solid state relay board and flow switch.

Refer to drawings: [18D29901-1](#) thru [18D29901-11](#) and [18S29911](#) thru [18S29919](#)

12.2.1 Solid State Relays

The solid-state relays are located within the electrical enclosure. Each SSR controls the operation of specific pneumatic solenoids, pump and refrigeration compressor, and heaters for temperature control.

12.2.1.1 Chamber Fan Control

The Chamber Fan (FAN2), when activated, allows the chamber volume to be stirred at variable rates.

12.2.1.2 Console Fans

The Console Fans (FAN1), when activated, allows console ventilation and refrigerant condenser cooling.

12.2.1.3 Fluid Cool Solenoid Valve

The Fluid Cool Solenoid Valve (SOL2), when activated, allows refrigerant to be injected into the refrigeration evaporator (EX1).

12.2.1.4 Air Supply Solenoid Valve

The Air/Gas Supply Solenoid Valve (SOL1), when activated, allows supply pressure to the system.

12.2.1.5 Pressure Vent Solenoid Valve

The Pressure Vent Solenoid Valve (SOL3), when deactivated (normally open), vents system pressure. It vents during all SHUTDOWN procedures, whenever power is removed from the system, and whenever the saturator pressure exceeds 110% of its controlled value due to system misalignment or malfunction.

12.2.1.6 Pre-Saturator Fill Solenoid Valve

The Pre-Saturator Fill Solenoid Valve (SOL4), when activated, allows distilled water to flow by gravity from the reservoir to the Pre-Saturator.

12.2.1.7 Pre-Saturator Heater

The Pre-Saturator Heater (H2,3) is two AC resistive heating elements in series, activated by dual solid-state relay SSR-AC1. The heat limit switch (HL2) must be in the normally closed position, indicating that Pre-Saturator heat is within allowable limits (i.e., below 100 °C).

12.2.1.8 Fluid Heater

The Fluid Heater (H1) is an AC resistive heating element, activated by a dual solid-state relay SSR-AC0. Heat limit switch (HL1) must be in the normally closed position, indicating that bath heat is within allowable limits (i.e., below 85 °C).

12.2.1.9 Expansion Valve Heater

The Expansion Valve Heater (H4,5), is a +24 Vdc heating element, activated by SSR-DC2. It is used to warm the gas in the section of pipe just prior to the expansion valve body, offsetting the cooling effects due to gas expansion.

12.2.1.10 Fluid Circulation Pump

The Fluid Circulation Pump (FP1) is connected to AC power through SSR-AC3.

12.2.1.11 Refrigeration Compressor

The Refrigeration Compressor (C1) is connected to AC power through SSR-AC2.

12.3 PNEUMATIC SYSTEM

The pneumatic system of the Model 2900 is designed as an open loop two-pressure system. Clean oil free instrument quality air (or nitrogen) enters the generating system at the pressure inlet and is admitted through the air supply ON/OFF solenoid valve (SOL1) to the pressure regulator (REG). Regulated supply pressure is indicated on the air supply pressure gauge (G1) and is also computer monitored with pressure transducer (T1). After regulation, the airstream passes through the mass flow meter (T4) to the flow control valve (V1). From the flow control valve, the airstream is admitted to the Pre-Saturator (PRESAT). The Pre-Saturator warms the airstream and brings it to near saturation at the elevated temperature. The pre-saturated airstream exits the Pre-Saturator and enters the saturator (SAT). As the nearly saturated air flows through the saturator, it is cooled to chamber fluid temperature forcing water vapor to condense as the air temperature establishes equilibrium with the chamber fluid. The saturation pressure, P_s (T2), and saturation temperature, T_s (RTD1), of the saturated airstream are measured at the final point of saturation. Upon exiting the saturator, the saturated airstream encounters the expansion valve (V2). After reducing the saturated airstream from saturation pressure to chamber pressure (expansion), the air passes through a small heat exchanger located within the chamber fluid jacket, conditioning the air to chamber fluid temperature. The airstream enters the test chamber located at the left side of the test chamber, at the desired humidity at chamber pressure (T3) and chamber temperature (RTD4) conditions. The airstream exits the test chamber through the exhaust port (if access ports are plugged), located at the bottom rear of the test chamber and out the exhaust fitting at the rear of the console.

Refer to drawings: [18D29901-1](#), [18D29901-5](#), [18D29901-8](#)

12.3.1 Pressure Measurement

There are five pressure transducers in the system. T1 is used for measurement of the supply pressure. T2 is used for control and measurement of the saturation pressure and T3 is used for the measurement of the chamber pressure. T5 and T6 are used for the control of the refrigeration system.

T1 = AIR/GAS SUPPLY

T2 = SATURATOR

T3 = CHAMBER

T5 = REFRIGERATION LOW-SIDE

T6 = REFRIGERATION HIGH-SIDE

12.3.2 Mass Flow Rate Measurement

The mass flow meter is used for feedback for control of the flow rate through the system.

T4 = MASS FLOW METER

12.3.3 Pre-Saturator

The airstream of a two-pressure generator must be saturated with water vapor at saturation temperature and at saturation pressure. This is accomplished by first passing the airstream through a Pre-Saturator (PRESAT). The Pre-Saturator is a vertical pressure vessel presenting a water surface to the incoming airstream and is maintained at a temperature approximately 15 to 20 °C warmer than the desired final saturation temperature. The airstream enters the Pre-Saturator and flows through a coil of tubing warming the airstream to Pre-Saturator water temperature, is then directed onto the water surface causing a circular flow pattern within the Pre-Saturator which supersaturates the airstream with reference to the final saturation temperature. After pre-saturation, the airstream exits the Pre-Saturator and is directed into the saturator.

Pre-Saturator water temperature, sensed by a 100Ω PRT (RTD2), is automatically adjusted and controlled by the control system. Heating of the Pre-Saturator is provided by two 400-watt stainless steel immersion type heaters (H2,3), controlled through solid state switching (SSR-AC1).

The Pre-Saturator water level is computer controlled via a liquid level transducer (LL2, LL2P) and a solenoid valve (SOL4). This allows distilled water to flow from the supply reservoir (RESERVOIR) maintaining a constant water level.

12.3.4 Reservoir

The reservoir is a pressure vessel constructed of 316 series stainless steel and holds an approximate working volume of 2 liters of distilled water for the Pre-Saturator. This vessel is maintained at saturation pressure and upon actuation of the pre-sat fill valve (SOL4), distilled water is allowed to flow freely to the Pre-Saturator. Reservoir water level (LL1, LL1P) is indicated on the computer monitor. If a low-level water condition is sensed during operation of the humidity generator, the computer/controller will signal the operator. Reservoir filling is then performed manually by the operator.

12.3.5 Saturator

Saturation of the airstream, upstream of the expansion valve, is accomplished in a single pass tube-in-shell type heat exchanger. This assembly is located within the insulated area behind the test chamber. The airstream from the Pre-Saturator (PRESAT), humidified to an absolute moisture content greater than saturation at chamber fluid temperature, is made to flow through the saturator on the shell side of the heat exchanger, while temperature-controlled chamber fluid flows through the tube side of the saturator in the opposite direction of the airstream. As the pre-saturated air flows through the saturator, excess water vapor is condensed as the airstream establishes thermal equilibrium with the chamber fluid, ensuring that the airstream is fully saturated at chamber fluid temperature. The Saturation Pressure (T2) and Saturation Temperature (RTD1) are monitored as the airstream exits the saturator. These measurements are used in the calculation and control of the desired humidity parameter.

12.3.6 Flow Control Valve

The Flow Control Valve (V1) is a 1/4 turn ball valve actuated by a gear reduced intelligent hybrid stepper motor and is used to control mass flow rates through the generating system. The computer-controlled flow control valve allows the mass flow rate to be controlled by varying the orifice of the flow control valve from nearly closed to fully open depending upon the required mass flow rate.

12.3.7 Expansion Valve

After exiting the saturator, the saturated high-pressure airstream is reduced to chamber pressure through the expansion valve. The Expansion Valve (V2) is a 1/4 turn ball valve actuated by a gear reduced intelligent hybrid stepper motor and allows the saturated high-pressure airstream to be reduced to chamber pressure by varying the orifice of the expansion valve from nearly closed to fully open depending upon the required saturator pressure and mass flow rate. Since the expansion process causes cooling, this valve is heated and thermally insulated to maintain the valve body above the dew point of the air stream while providing for a more isothermal expansion.

12.3.8 Chamber Pressure

Test chamber pressure (T3) is ambient and not controlled.

12.3.9 Test Chamber

The Model 2900 Humidity Generation System incorporates a test chamber that is fluid jacketed. The chamber fluid provides temperature conditioning, as well as thermal stability, to the test space and associated humidity generating components.

The air inlet is located at the left side of the chamber and is a 1/4" FPT thread fitting. The air outlet is located at the bottom rear of the chamber. The chamber pressure measurement port is located at the upper left rear corner. The chamber temperature probe (RTD4) can be positioned where needed within the chamber. Excess chamber RTD cable may be pulled into or out of the chamber by removing the top console panel and then carefully feeding the cable through the access port.

12.4 FLUID SYSTEM

In this closed loop non-pressurized system, temperature conditioned water/glycol, circulated by a magnetically coupled centrifugal pump (FP1), flows from the pump outlet, splits into two paths, one over the temperature control sensor (RTD1) and into the saturator and the other into the chamber fluid jacket. The chamber fluid is pumped around the test chamber and through the saturator (SAT) and then into the refrigeration evaporator (EX1) where excess heat is removed. After cooling, chamber fluid enters the immersion heater housing and flows over the immersion heater (H1) and exits to the circulation pump intake, completing the chamber fluid circuit.

Refer to drawing: [18D29901-1](#), [18D29901-6](#)

12.4.1 Liquid Level Measurement

There are two liquid level indicators in the system. One is used for the measurement of the Water Reservoir (LL1/LL1P) and the other is used to maintain the Pre-Saturator (LL2/LL2P) level constant.

12.4.2 Fluid Flow Measurement

There is one pressure switch (FS1) used to indicate that the circulation pump is running, and water is circulating water within the system.

12.4.3 Temperature Controlled Chamber Fluid

The Model 2900 humidity generating system incorporates water/glycol as the heat transfer medium. This provides temperature conditioning of the test chamber and humidity generating components, resulting in inherent temperature stability, allowing a very stable humidity to be generated.

Note - *An appropriate amount of propylene glycol must be added to the chamber fluid if the system is to be operated to -10 °C.*

12.4.4 Chamber Fluid Heating

The chamber fluid is heated by a 1000-watt, stainless steel immersion heater (H1). This heater is installed into a copper heater housing and is located in the main fluid path, between the refrigeration evaporator (EX1) and circulation pump (FP1) inlet. Primary power to the immersion heater is switched by a solid-state relay (SSR-AC0). High temperature disconnect of the immersion heater is provided for by a temperature sensing element (HL1) that disconnects the primary power to the immersion heater.

12.4.5 Chamber Fluid Refrigeration

The chamber fluid is cooled by an R134A, hermetic type, refrigeration system. "Refrigerant 134A" is compressed from a low-pressure vapor into a heat laden high-pressure vapor by the refrigeration compressor (C1). High pressure vapor flows to the air-cooled condenser (CON) where it is cooled to a high-pressure liquid as heat is removed. Condensed refrigerant then flows through the filter-drier (FD) to the fluid cool solenoid (SOL2) where refrigerant is metered into the refrigerant evaporator (EX1). The refrigerant expands and changes to a low-pressure vapor as it absorbs heat. Heat laden vapor is then piped to the suction side of the compressor and the cycle is repeated. During times of high heat demand, such as a temperature setpoint change (i.e., 25 °C to 50 °C), the refrigeration compressor will be automatically shut down by the controller until such time as cooling is again demanded. Once started, the compressor will then remain on as cooling is continuously required to hold the chamber fluid at setpoint temperature.

12.4.6 Temperature Measurement

There are five 100Ω Platinum Resistance Thermometer probes in the system. The probes are used for the control and measurement of the Saturation Temperature (RTD1), Pre-Saturator (RTD2), Expansion Valve Temperature (RTD3), Chamber Temperature (RTD4) and Cabinet Temperature (RTD5).

12.4.7 Fluid Jacket Door Option

The fluid jacket door option uses a fluid jacket attached to the inside of the chamber door. This allows the chamber to have six sides of controlled fluid circulating throughout for better temperature uniformity within the chamber. Refer to the Thunder Scientific website (www.thunderscientific.com) for more information on installing or removing the fluid jacket door option.

13 MAINTENANCE

The Model 2900 Humidity Generation System requires little periodic maintenance. Following the proper operating procedures as given in this manual will help assure trouble-free operation of this system.

CAUTION!

ALWAYS USE THE FILE>TURN OFF COMMAND TO PROPERLY EXIT THE SOFTWARE AND SHUTDOWN THE COMPUTERS SO THAT THE MAIN POWER SWITCH CAN BE SWITCHED OFF.

13.1 DRAIN PRE-SATURATOR

Interval: **Every calibration cycle or Yearly**

- 1) Disconnect the main power cable on the rear panel.
- 2) Disconnect air supply hose and remove the air supply elbow.
- 3) Remove the rear panel using the Torx driver provided.
- 4) Locate the Pre-Saturator drain valve to the left of the pump motor.
- 5) Remove the cap on the Pre-Sat drain valve using a 9/16" wrench.
- 6) Place a one-liter container under the drain valve and open the valve to drain approximately 850 mL of water.
- 7) Check to see if the water is clear of any foreign matter.
- 8) Close the drain valve and replace the cap when finished draining the Pre-Saturator.
- 9) Replace rear panel and air supply elbow fitting. Reconnect air supply hose.
- 10) Reconnect the main power cable on the rear panel.

13.2 CHAMBER FLUID

Interval: **Yearly**

Check fluid level yearly. Refer to section [2.12.3.1 Chamber Fluid Filling Procedure](#)

13.3 AIR INPUT FILTERS (MOBILE CART)

Interval: **Yearly**

- 1) Disconnect main power.
- 2) Turn off air supply valve.
- 3) Locate the two filters on the underside of the cart.
- 4) Vent any air pressure by turning each filter housing drain valve.
- 5) Locate filter furthest from the regulator. Push up and twist filter housing counterclockwise to release housing.
- 6) Pull filter housing straight down to avoid damage to filter within.
- 7) Remove coalescing/particulate filter by rotating filter retainer counterclockwise.
- 8) Replace filter with filter replacement #4438-01.
- 9) Replace filter housing by pushing up and rotating clockwise.

- 10) Locate filter closest to the regulator. Push up and twist filter housing counterclockwise to release housing.
- 11) Pull filter housing straight down to avoid damage to filter within.
- 12) Remove filter by rotating counterclockwise.
- 13) Replace filter with oil removal filter replacement #4444-01.
- 14) Replace filter housing by pushing up and rotating clockwise.
- 15) Make sure the drain valves are closed.
- 16) Rotate air supply valve to the ON position.
- 17) Operate system checking for leaks.

Refer to drawings: [18D29910-1](#), [18D29910-2](#), [18D29910-3](#)

13.4 CIRCULATION PUMP MOTOR

Interval: **Yearly**

- 1) Apply SAE 20 lubrication to pump motor at lubrication points.

Refer to drawing: [18D29901-3](#)

13.5 PRE-SATURATOR LIQUID LEVEL CHECKOUT

Interval: **As needed**

The Pre-Saturator liquid level is fixed by the physical length of the Pre-Saturator liquid level probe (LL2P) mounted on the bottom of the Pre-Saturator assembly.

The following procedure is designed to test the integrity of the liquid level circuit (LL2, LL2P) and need only be performed if it is suspected that the liquid level circuitry is malfunctioning:

- 1) Remove front console access panel to locate LL2.
- 2) Toggle system "POWER" switch to ON and allow the system to power up.
- 3) Locate the LL2 liquid level probe (LL2P) and disconnect the cable. The red LED should be illuminated.
- 4) Short the center pin of the cable to chassis ground. The green LED should illuminate.
- 5) Repeat steps (3) and (4) as necessary to verify correct operation. If step (3) or (4) fails, the board or cable requires repair. This board is not adjustable.
- 6) Reconnect the cable to the liquid level probe.
- 7) Perform a [shutdown system](#) then switch system "POWER" to OFF.
- 8) Replace front console access panel.

13.6 RESERVOIR LIQUID LEVEL CHECKOUT

Interval: **As needed**

This procedure need not be performed unless it is suspected that the reservoir liquid level transducer is malfunctioning.

- 1) Remove left side console access panel and locate the reservoir level probe (LL1P).

- 2) Toggle system "POWER" switch to ON and allow the system to power up.
- 3) Select Fluid Levels from the Generator Utilities menu.
- 4) Note reservoir level and remove the liquid level probe cable at the LL1P probe. The indicated level should indicate zero.
- 5) Replace the liquid level probe cable at the LL1P probe and indicated level should indicate the prior noted level.
- 6) Perform a [shutdown system](#) then switch system "POWER" to OFF.
- 7) Replace left side console access panel.

13.7 WARNING AND ERROR MESSAGES

Prior to system start-up, and during humidity generation, the system monitors itself for warnings, errors and sources of possible malfunction. All warning and error messages are automatically logged in the status log and displayed in the [2900 Reported Errors tab](#). Catastrophic errors will result in an automatic shutdown. While it is not necessary to understand the error message, it is important to write down the error message exactly as it appears when contacting Thunder Scientific for technical support.

13.7.1 Saturation Temperature at Minimum Limit

This error indicates the saturation temperature probe is reading below its minimum value for a specific amount of time. A failed probe or incorrect calibration are the most common causes of this error.

13.7.2 Saturation Temperature Over Range or at Maximum Limit

This error indicates the saturation temperature probe is reading above its maximum limit value for a specific amount of time or has reached its over range point. A failed probe or incorrect calibration are the most common causes of this error, but other causes are also possible such as the probe was inserted in the incorrect location after a calibration or there is a faulty heater control component.

13.7.3 Pre-Saturation Temperature at Minimum Limit

This error indicates the pre-saturation temperature probe is reading below its minimum value for a specific amount of time. A failed probe or incorrect calibration are the most common causes of this error.

13.7.4 Pre-Saturation Temperature Over Range or at Maximum Limit

This error indicates the pre-saturation temperature probe is reading above its maximum limit value for a specific amount of time or has reached its over range point. A failed probe or incorrect calibration are the most common causes of this error, but other causes are also possible such as the probe was inserted in the incorrect location after a calibration or there is a faulty heater control component.

13.7.5 Expansion Valve Temperature at Minimum Limit

This error indicates the expansion valve temperature probe is reading below its minimum value for a specific amount of time. A failed probe or incorrect calibration are the most common causes of this error.

13.7.6 Expansion Valve Temperature Over Range or at Maximum Limit

This error indicates the expansion valve temperature probe is reading above its maximum limit value for a specific amount of time or has reached its over range point. A failed probe or incorrect calibration are the most common causes of this error, but other causes are also possible such as the probe was inserted in the incorrect location after a calibration or there is a faulty heater control component.

13.7.7 Chamber Temperature at Minimum Limit

This error indicates the chamber temperature probe is reading below its minimum value for a specific amount of time. A failed probe or incorrect calibration are the most common causes of this error.

13.7.8 Chamber Temperature Over Range or at Maximum Limit

This error indicates the chamber temperature probe is reading above its maximum limit value for a specific amount of time or has reached its over range point. A failed probe or incorrect calibration are the most common causes of this error, but other causes are also possible such as the probe was inserted in the incorrect location after a calibration.

13.7.9 Cabinet Temperature Over Range or at Minimum/Maximum Limit - Check Cabinet Fans

This warning indicates the cabinet temperature probe is reading below its minimum value or above its maximum value for a specific amount of time. Insufficient floor space around the generator, running with panels removed or cabinet fans not operating are the most common cause of this warning. It also possible to receive this error if the generator is being operated in an environment that is outside the generators operating temperature range.

For more information, refer to section [2.11 Facility Requirements](#)

13.7.10 Insufficient Supply Pressure to Generate

This error indicates there is insufficient supply pressure to start generating or to continue generating. If using the air compressor system (ASC), make sure it is on and that all valves are open. If using in-house or another air supply system, make sure it is on and meets the supply pressure requirements for the generator.

For more information, refer to section [2.11 Facility Requirements](#)

13.7.11 Supply Pressure Over Range or at Maximum Limit

This error indicates the pressure transducer T1 is over range or has been at its maximum limit value for a specific amount of time. Check the supply pressure regulators to assure the incoming supply pressure is regulated to the supply pressure requirements for the generator.

For more information, refer to section [2.11 Facility Requirements](#)

13.7.12 Saturation Pressure at Minimum Limit

This error indicates the pressure transducer T2 is reading below its minimum value for a specific amount of time. A failed transducer or incorrect calibration are the most common causes of this error.

13.7.13 Saturation Pressure Over Range or at Maximum Limit

This error indicates the pressure transducer T2 is over range or has been at its maximum limit value for a specific amount of time. A failed transducer or incorrect calibration are the most common causes of this

error. Also, if using fittings or tubing connected to the chamber inlet, assure it can flow the desired flow rate and is not causing any back pressure or blockage.

13.7.14 Saturation Pressure Transducer Not Responding

This error indicates the pressure transducer T2 is not responding to commands from the computer. A failed transducer is the most common causes of this error, but a disconnected or damaged serial cable or serial adapter could also be the cause.

13.7.15 Chamber Pressure at Minimum Limit

This error indicates the pressure transducer T3 is reading below its minimum value for a specific amount of time. A failed transducer or incorrect calibration are the most common causes of this error.

13.7.16 Chamber Pressure Over Range or at Maximum Limit

This error indicates the pressure transducer T3 is over range or has been at its maximum limit value for a specific amount of time. A failed transducer or incorrect calibration are the most common causes of this error.

13.7.17 Chamber Pressure Transducer Not Responding

This error indicates the pressure transducer T3 is not responding to commands from the computer. A failed transducer is the most common causes of this error, but a disconnected or damaged serial cable or serial adapter could also be the cause.

13.7.18 Mass Flow Rate at Minimum Limit

This error indicates the flow transducer T4 is reading below its minimum value for a specific amount of time. A wet flow meter is the most common cause of this error. Other causes include a failed transducer or incorrect calibration.

13.7.19 Mass Flow Rate Over Range or at Maximum Limit

This error indicates the flow transducer T4 is over range or has been at its maximum limit value for a specific amount of time. A wet flow meter is the most common cause of this error. Other causes include a failed transducer or incorrect calibration.

13.7.20 Refrigeration Compressor Low Side Pressure at Minimum Limit

This error indicates the pressure transducer T5 is reading below its minimum value for a specific amount of time. A failed transducer is the most common cause of this error. Other causes include refrigeration system failure or leak.

13.7.21 Refrigeration Compressor Low Side Pressure Over Range or at Maximum Limit

This error indicates the pressure transducer T5 is over range or has been at its maximum limit value for a specific amount of time. A refrigeration system failure is the most common cause of this error. It also possible to receive this error if the generator is being operated in an environment that is outside the generators operating temperature range.

For more information, refer to section [2.11 Facility Requirements](#)

13.7.22 Refrigeration Compressor High Side Pressure at Minimum Limit

This error indicates the pressure transducer T6 is reading below its minimum value for a specific amount of time. A failed transducer is the most common cause of this error. Other causes include refrigeration system failures.

13.7.23 Refrigeration Compressor High Side Pressure Over Range or at Maximum Limit

This error indicates the pressure transducer T6 is over range or has been at its maximum limit value for a specific amount of time. A refrigeration system failure is the most common cause of this error. It is also possible to receive this error if there is insufficient floor space around the generator or if the cabinet fans are not operating.

13.7.24 Flow Valve Reported Error:

This error indicates the stepper motor for the valve V1 is reporting an internal error. A failed stepper motor or a jammed flow valve are the most common causes of this error. It is important to relay the number displayed after this error when contacting Thunder Scientific for technical support.

13.7.25 Flow Valve Failed to Find Home Position

This error indicates the stepper motor for the valve V1 is unable to find its home position. A failed stepper motor or a jammed flow valve are the most common causes of this error.

13.7.26 Flow Valve at Minimum Limit

This error indicates the valve V1 has been at its minimum position for a specific amount of time. A wet flow meter is the most common cause of this error.

13.7.27 Flow Valve at Maximum Limit

This error indicates the valve V1 has been at its maximum position for a specific amount of time. Insufficient supply pressure source for the given flow setpoint, or a block chamber inlet are the most common cause of this error. Other causes include a frozen saturator caused by extended operation at temperatures below freezing is. Try reducing the mass flow rate setpoint to 20 L/min or even 10 L/min when operating at temperatures below freezing.

13.7.28 Expansion Valve Reported Error:

This error indicates the stepper motor for the valve V2 is reporting an internal error. A failed stepper motor or a jammed expansion valve are the most common causes of this error.

13.7.29 Expansion Valve Failed to Find Home Position

This error indicates the stepper motor for the valve V2 is unable to find its home position. A failed stepper motor or a jammed expansion valve are the most common causes of this error.

13.7.30 Expansion Valve at Minimum Limit - Check for air leaks

This warning indicates the valve V2 has been at its minimum position for a specific amount of time. An air leak is the most common cause of this error.

13.7.31 Expansion Valve at Maximum Limit - Reduce Mass Flow Rate

This warning indicates the valve V2 has been at its maximum position for a specific amount of time. Operating the generator at high humidity with high mass flow rates is the most common cause of this

warning. Try reducing the mass flow rate setpoint to 30 L/min when generating 95% Relative Humidity or equivalent and 20 L/min when generating 98% Relative Humidity or equivalent.

13.7.32 Distilled Water Reservoir is Empty

This error indicates the water reservoir is empty and the system had to shutdown.

For more information on adding water, refer to section [5.1.1 Fill Water Reservoir](#)

13.7.33 Distilled Water Reservoir is Low

This is only a warning that the water reservoir is low and that you should fill it soon.

For more information on adding water, refer to section [5.1.1 Fill Water Reservoir](#)

13.7.34 Unable to Fill Pre-Saturator

This error indicates the pre-saturation was unable to fill. An air bubble in the fill line is the most common cause of this error. The air bubble can occur if the generator recently shutdown due to an empty water reservoir. Assure the reservoir is full and try to manually fill the pre-sat.

For more information, refer to section [5.2.1 Pre-saturator Level](#)

13.7.35 No Fluid Flow

This error indicates no coolant flow was detected within the fluid circulation system. Make sure the fluid circulation system is full of coolant water. Other causes include failed fluid pump or blown fuse.

For more information, refer to section [2.12.3.1 Chamber Fluid Filling Procedure](#)

13.7.36 No Saturation Fluid Heat

This warning indicates the heater H1 for the fluid circulation system has been running at full power without any increase in temperature for a given amount of time. Possible causes include a failed heater H1, tripped heat limit switch HLS1 or the RTD 1 temperature probe is not installed or is installed in the wrong location.

13.7.37 No Pre-Saturator Heat

This warning indicates the heater H2 and H3 for the pre-saturator have been running at full power without any increase in temperature for a given amount of time. Possible causes include a failed heater H2 and/or H3, tripped heat limit switch HLS2 or the RTD 2 temperature probe is not installed or is installed in the wrong location.

13.7.38 No Expansion Valve Heat

This warning indicates the heater H4 and H5 for the expansion valve have been running at full power without any increase in temperature for a given amount of time. Possible causes include a failed heater H4 and/or H5, tripped heat limit switch HLS3 or the RTD 3 temperature probe is not installed or is installed in the wrong location.

13.7.39 System Failed to Vent Pressure on Shutdown

This warning indicates the system failed to vent off pressure after a shutdown within a given amount of time. A bad pressure vent solenoid SOL3 is the most common cause of this warning.

13.7.40 Mass Flow Rate is being limited to achieve Humidity setpoint.

This warning occurs when the system is limiting mass flow rate to 20 L/min when the Humidity setpoint is greater than 95 %RH. This can occur if the user changes temperature and humidity at the same time or if the user is changing temperature when generating a humidity that is sensitive to temperature deltas between the chamber and saturation temperature. The system limits the flow to assure a proper pressure delta is maintained at low saturation pressures. If this warning does not clear once the system has stabilized at its humidity and temperature setpoints then a mass flow rate setpoint reduction is recommended to remove the warning.

13.7.41 Insufficient Supply Pressure to reach setpoint

This warning occurs when the system is set to generate a humidity value that requires more pressure than the supply has available. This can occur if the user changes temperature and humidity at the same time or if the user is changing temperature when generating a humidity that is sensitive to temperature deltas between the chamber and saturation temperature. If this warning does not clear once the system has stabilized at its temperature setpoint then check the supply pressure as it might be insufficient for the desired humidity setpoint.

14 DRAWINGS AND DIAGRAMS

This section contains drawings and diagrams of the Model 2900 Humidity generator to assist the user in better understanding the operation and location of components of the system.

Note – *All drawings and diagrams contained within this manual are proprietary information which are protected by copyright. All rights are reserved. No part of these drawings and diagrams may be reproduced or transmitted in any form or by any means, electronic or mechanical, including photocopying and recording, for any purpose without the prior written consent of Thunder Scientific Corporation.*

REVISIONS				
DWN	REV.	DESCRIPTION	DATE	APP. BY
DWF	A	TRANSDUCERS UPDATED - TIMER ADDED IN ELEC. BOX	6/23/2020	BB

ITEM NO.	FIND #	TSC STOCKCODE	DESCRIPTION	QTY.	ITEM NO.	FIND #	TSC STOCKCODE	DESCRIPTION	QTY.
55	V3	PR4-EPRT	1/4" PLUG VALVE	1	28	NI9136	N784238	CDAQ-9136 4 SLOT CONTROLLER	1
54	V2	D16A29022	EXPANSION VALVE ASSEMBLY	1	27	NI 9403	N779787	TTL Digital I/O Module (32 CH)	1
53	V1	D16A29021	FLOW VALVE ASSEMBLY	1	26	NI 9401	N779351	TTL Digital I/O Module (8 CH)	1
52	TR5	D20A29043	2900 TIMER RELAY ASSEMBLY	1	25	NI 9216	N783664-01	24-BIT 100 Ω RTD ANALOG INPUT MODULE	1
51	T6	P528-300	0 - 300 PSI PRESSURE SENSOR	1	24	NI 9209	N783729	±10V, 24-Bit Analog Input Module	1
50	T5	P528-100	0 - 100 PSI PRESSURE SENSOR	1	23	MOXA	UPOINT1650-8	USB - SERIAL HUB	1
49	T4	EFM5700-50L	MASS FLOW TRANSDUCER	1	22	MEM	SD1001	2 GB FLASH MEMORY CARD	1
48	T3	CPT6020-17	8 - 17 PSIA PRECISION TRANSDUCER	1	21	LL2P	D18A29063	PRESAT LIQUID LEVEL PROBE	1
47	T2	CPT6020-160	0 - 160 PSIA PRECISION TRANSDUCER	1	20	LL2	D92A00043	LIQUID LEVEL ALARM PROBE ASSY	1
46	T1	D19A29072	SUPPLY TRANSDUCER ASSEMBLY	1	19	LL1P	D94A25049	RESERVOIR LIQUID LEVEL PROBE ASSY	1
45	SSRB1,2	G4PB4	4 CHANNEL MOUNTING RACK	2	18	LL1	D94A25051	LIQUID LEVEL, RES PROBE ASSY	1
44	SSR-DC0-7	G4DC5	G4 DC Output 5-200 VDC, 5 VDC Logic	8	17	HMI	UTC-510GP	UTC-510 10.1" TOUCH COMPUTER	1
43	SSR-AC2,3	EL240A10-05	5 AMP SS RELAY	2	16	HLS2	HLSW2-EPOXY	190 °F THERMOSTAT - EPOXY COATED	1
42	SSR-AC0,1	UPD2415DF	15 Amp SS Relay	2	15	HLS1	HLSW1	212° THERMOSTAT SWITCH	1
41	SOL4	A2037	PRE SAT FILL SOLENOID VALVE	1	14	H2,3	L3A94	400 WATT CARTRIDGE HEATER	2
40	SOL3	A2231	PRESSURE VENT SOLENOID VALVE	1	13	H1	N8A21	1KW CARTRIDGE HEATER	1
39	SOL2	K2X2833	COOL SOLENOID VALVE	1	12	G1	G6X114	200 PSIG PRESSURE GAUGE	1
38	SOL1	A2033	AIR SUPPLY SOLENOID VALVE	1	11	FS1	D18A29060	PRESSURE SWITCH ASSEMBLY	1
37	RV1	S4C-150	1/4" MALE NPT ADJUSTABLE RELIEF VALVE	1	10	FP1	D17A29059	FLUID PUMP ASSEMBLY	1
36	RTD5	S17624	CABINET TEMPERATURE PROBE	1	9	FD	C-032-S	REFRIGERATION FILTER / DRYER	1
35	RTD4	5606-50-B	CHAMBER TEMPERATURE PROBE	1	8	FAN2	D17A29065	CHAMBER FAN ASSEMBLY	1
34	RTD3	5606-50-B	EXPANSION VALVE TEMPERATURE PROBE	1	7	FAN1	3414NHH	24 VDC AXIAL FAN	6
33	RTD2	5606-50-B	PRE SAT TEMPERATURE PROBE	1	6	EX1	D16A29045	EVAPORATOR WELD ASSEMBLY	1
32	RTD1	5606-50-B	SATURATION TEMPERATURE PROBE	1	5	DC3	SD-15A-05	5VDC POWER SUPPLY	1
31	RESERVOIR	D16A29015	RESERVOIR ASSEMBLY	1	4	DC2	VE-LU3-EU	24V 200W POWER SUPPLY	1
30	REG	F10001062T	PRESSURE REGULATOR	1	3	DC1	VE-LU1-EW	12V 100W POWER SUPPLY	1
29	PEM	EF-12	POWER ENTRY MODULE	1	2	CON	BT-COND	CONDENSER ASSEMBLY	1
					1	C1	COMPR-220V	220V REFRIGERATION COMPRESSOR	1

DO NOT SCALE FROM DRAWING		THIRD ANGLE PROJECTION	PROPRIETARY NOTICE THIS DRAWING AND INFORMATION CONTAINED WITHIN IS PROPRIETARY TO THUNDER SCIENTIFIC AND CANNOT BE COPIED OR REPRODUCED WITHOUT SPECIFIC WRITTEN PERMISSION			Thunder Scientific Corporation 623 Wyoming S.E. Albuquerque, NM 87123		
NEXT ASSY	USED ON	TOLERANCES .XXX ±.010 .XX ±.015 < ±.50° UNLESS NOTED OTHERWISE	DRAWN	FURRY	08/05/2018	SIZE A	DWG. NO. 18D29901	REV A
APPLICATION			APPROVED	BB	08/21/2018			

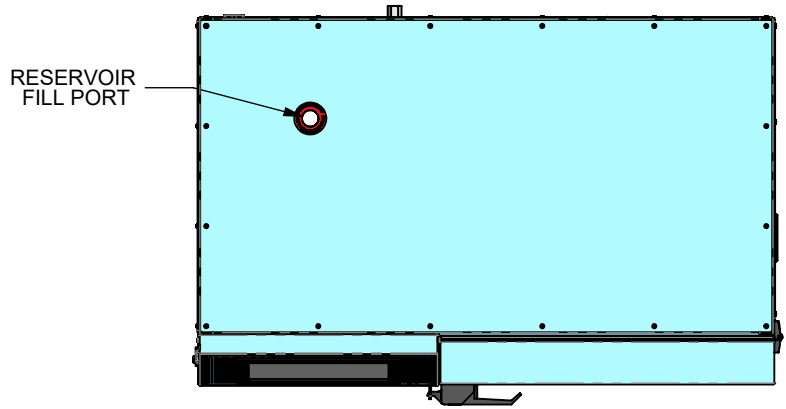

RESERVOIR FILL PORT

TOP VIEW

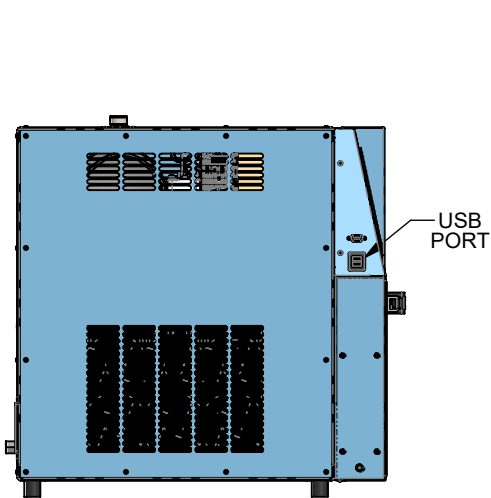

USB PORT

LEFT SIDE

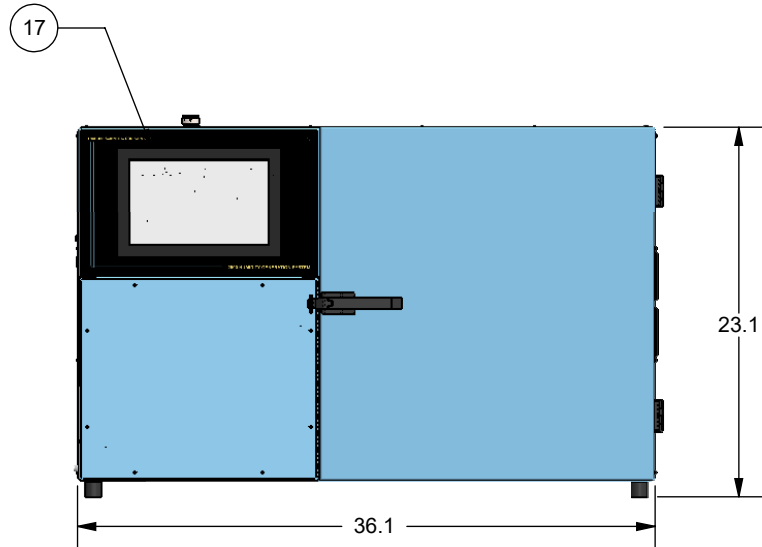

FRONT

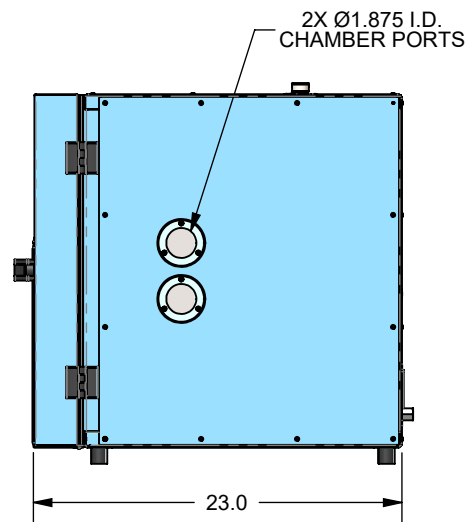

RIGHT SIDE

DO NOT SCALE FROM DRAWING		THIRD ANGLE PROJECTION	PROPRIETARY NOTICE THIS DRAWING AND INFORMATION CONTAINED WITHIN IS PROPRIETARY TO THUNDER SCIENTIFIC AND CANNOT BE COPIED OR REPRODUCED WITHOUT SPECIFIC WRITTEN PERMISSION			Thunder Scientific Corporation 623 Wyoming S.E. Albuquerque, NM 87123		
						2900 Components		
		TOLERANCES .XXX ±.010 .XX ±.015 ∠ ±.50° UNLESS NOTED OTHERWISE		DRAWN FURRY APPROVED BB ISSUED DWF	08/05/2018 08/21/2018 8/21/2018	SIZE A WT. 267.45	DWG. NO. 18D29901	REV A SHEET 2 OF 11
NEXT ASSY	USED ON	APPLICATION						

CHAMBER FAN COMPONENTS
SEE 18D29908

8

PRESAT DRAIN VALVE (V3)

55

CHAMBER VENT PORT

EXPANSION TANK OVERFLOW TUBE

15

14

21

33

10

11

13

16

37

AIR INLET

48

47

19

51

50

29

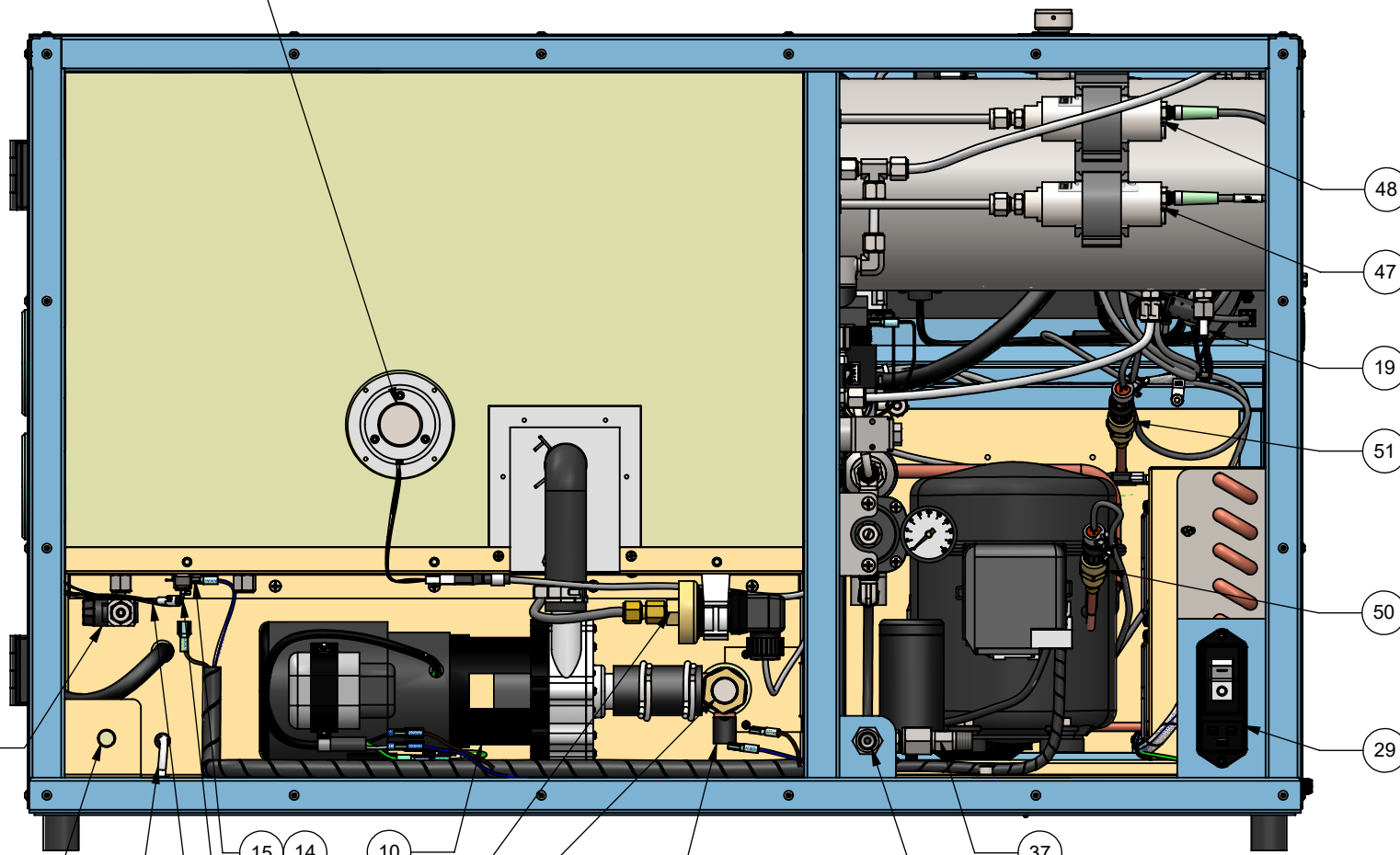

DO NOT SCALE FROM DRAWING		THIRD ANGLE PROJECTION	PROPRIETARY NOTICE THIS DRAWING AND INFORMATION CONTAINED WITHIN IS PROPRIETARY TO THUNDER SCIENTIFIC AND CANNOT BE COPIED OR REPRODUCED WITHOUT SPECIFIC WRITTEN PERMISSION		Thunder Scientific Corporation 623 Wyoming S.E. Albuquerque, NM 87123		
					2900 Components		
NEXT ASSY		USED ON	TOLERANCES .XXX ±.010 .XX ±.015 ∠ ±.50° UNLESS NOTED OTHERWISE		DRAWN FURRY 08/05/2018 APPROVED BB 08/21/2018 ISSUED DWF 8/21/2018	SIZE A DWG. NO. 18D29901 WT. 267.45	REV A SHEET 3 OF 11
APPLICATION							

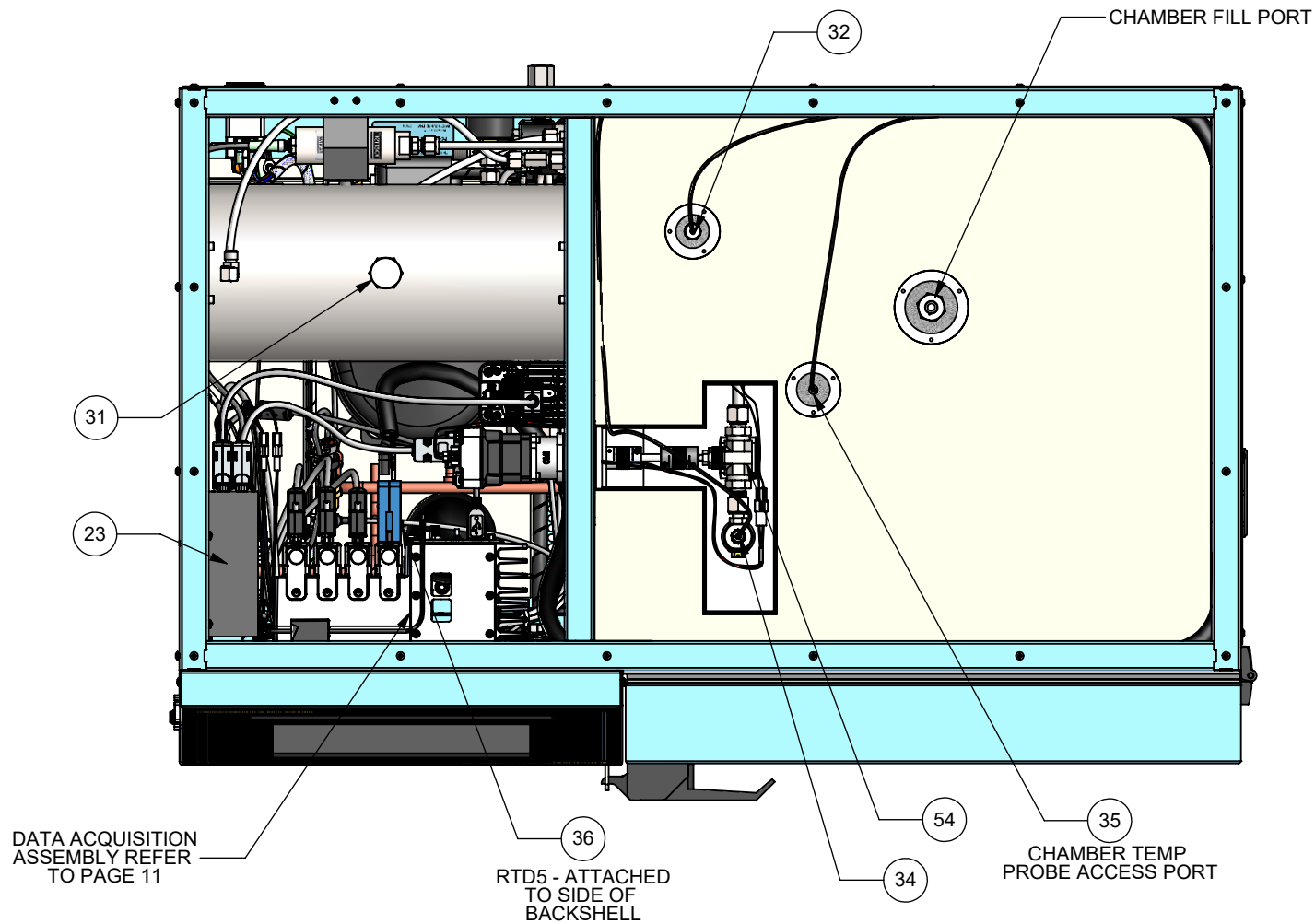

DO NOT SCALE FROM DRAWING		THIRD ANGLE PROJECTION	PROPRIETARY NOTICE THIS DRAWING AND INFORMATION CONTAINED WITHIN IS PROPRIETARY TO THUNDER SCIENTIFIC AND CANNOT BE COPIED OR REPRODUCED WITHOUT SPECIFIC WRITTEN PERMISSION			Thunder Scientific Corporation 623 Wyoming S.E. Albuquerque, NM 87123		
			TOLERANCES .XXX ±.010 .XX ±.015 ∠ ±.50° UNLESS NOTED OTHERWISE			DRAWN FURRY 08/05/2018 APPROVED BB 08/21/2018 ISSUED DWF 8/21/2018		2900 Components
NEXT ASSY	USED ON				SIZE	DWG. NO.	REV	
APPLICATION					A	18D29901	A	
					WT. 267.45		SHEET 4 OF 11	

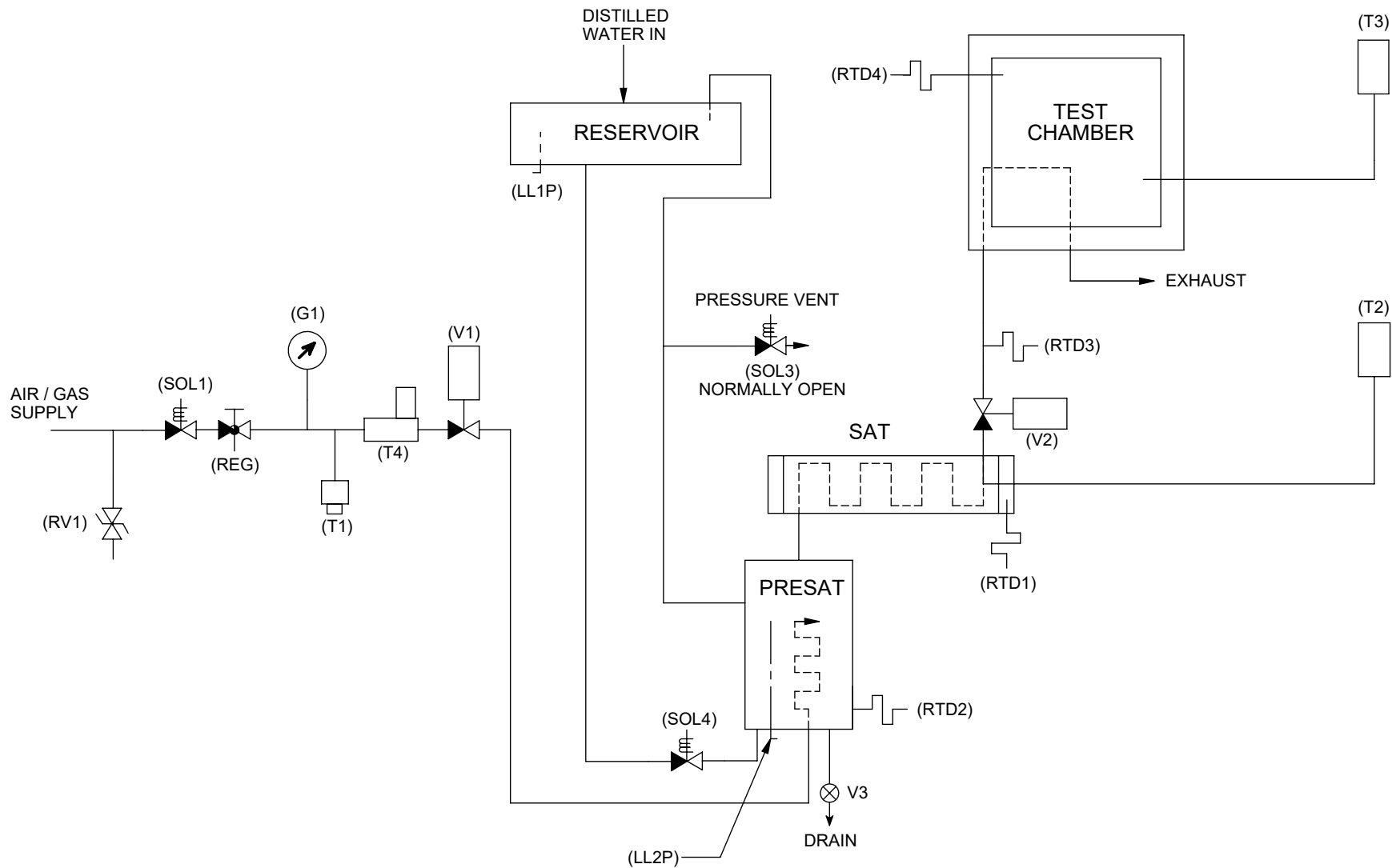

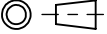
DO NOT SCALE FROM DRAWING		THIRD ANGLE PROJECTION 	PROPRIETARY NOTICE THIS DRAWING AND INFORMATION CONTAINED WITHIN IS PROPRIETARY TO THUNDER SCIENTIFIC AND CANNOT BE COPIED OR REPRODUCED WITHOUT SPECIFIC WRITTEN PERMISSION		Thunder Scientific Corporation 623 Wyoming S.E. Albuquerque, NM 87123			
		TOLERANCES .XXX ±.010 .XX ±.015 ∠ ±.50° UNLESS NOTED OTHERWISE	DRAWN	FURRY	08/05/2018			
NEXT ASSY			USED ON	APPROVED	BB	08/21/2018		
APPLICATION			ISSUED	DWF	8/21/2018		Pneumatic Schematic	
			SIZE	DWG. NO.		REV		
			A	18D29901		A		
			WT. 267.45		SHEET 5 OF 11			

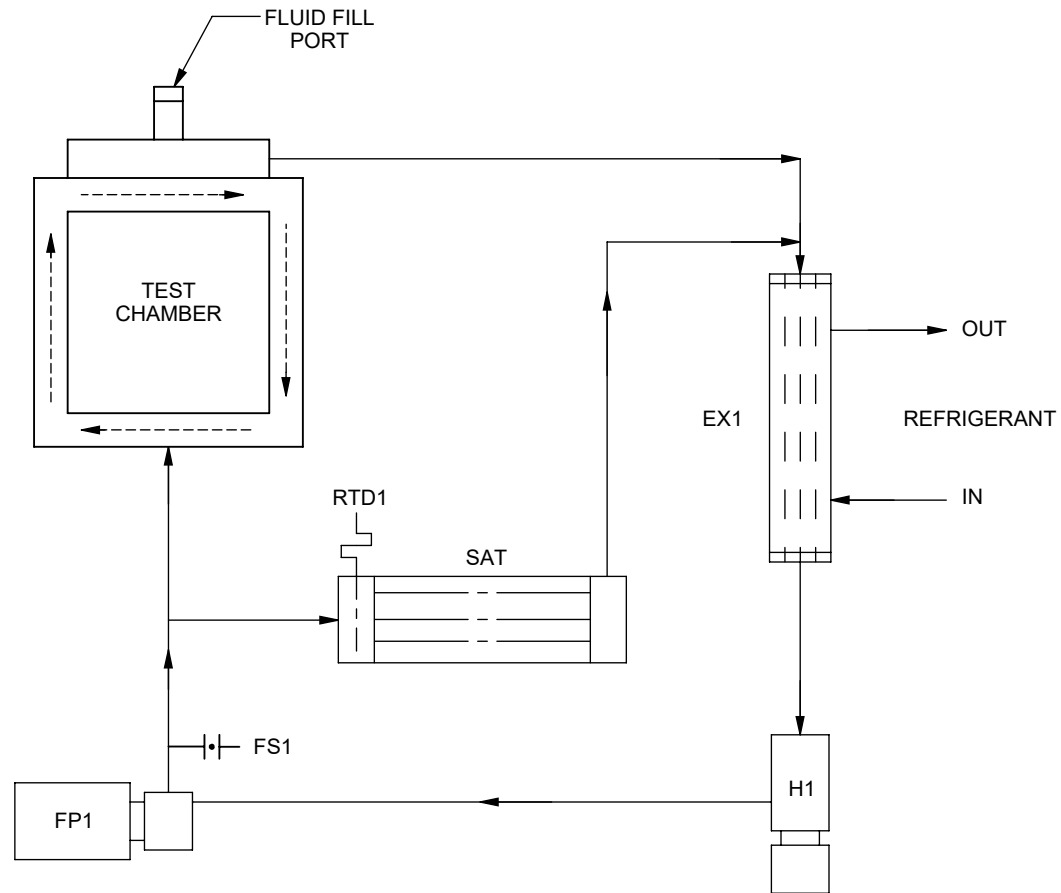

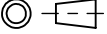
DO NOT SCALE FROM DRAWING		THIRD ANGLE PROJECTION 	PROPRIETARY NOTICE THIS DRAWING AND INFORMATION CONTAINED WITHIN IS PROPRIETARY TO THUNDER SCIENTIFIC AND CANNOT BE COPIED OR REPRODUCED WITHOUT SPECIFIC WRITTEN PERMISSION			Thunder Scientific Corporation 623 Wyoming S.E. Albuquerque, NM 87123		
		TOLERANCES .XXX ±.010 .XX ±.015 ∠ ±.50° UNLESS NOTED OTHERWISE	DRAWN	FURRY	08/05/2018	Fluid Schematic SIZE A DWG. NO. 18D29901 REV A		
NEXT ASSY	USED ON		APPROVED	BB	08/21/2018			
APPLICATION			ISSUED	DWF	8/21/2018	WT. 267.45		SHEET 6 OF 11

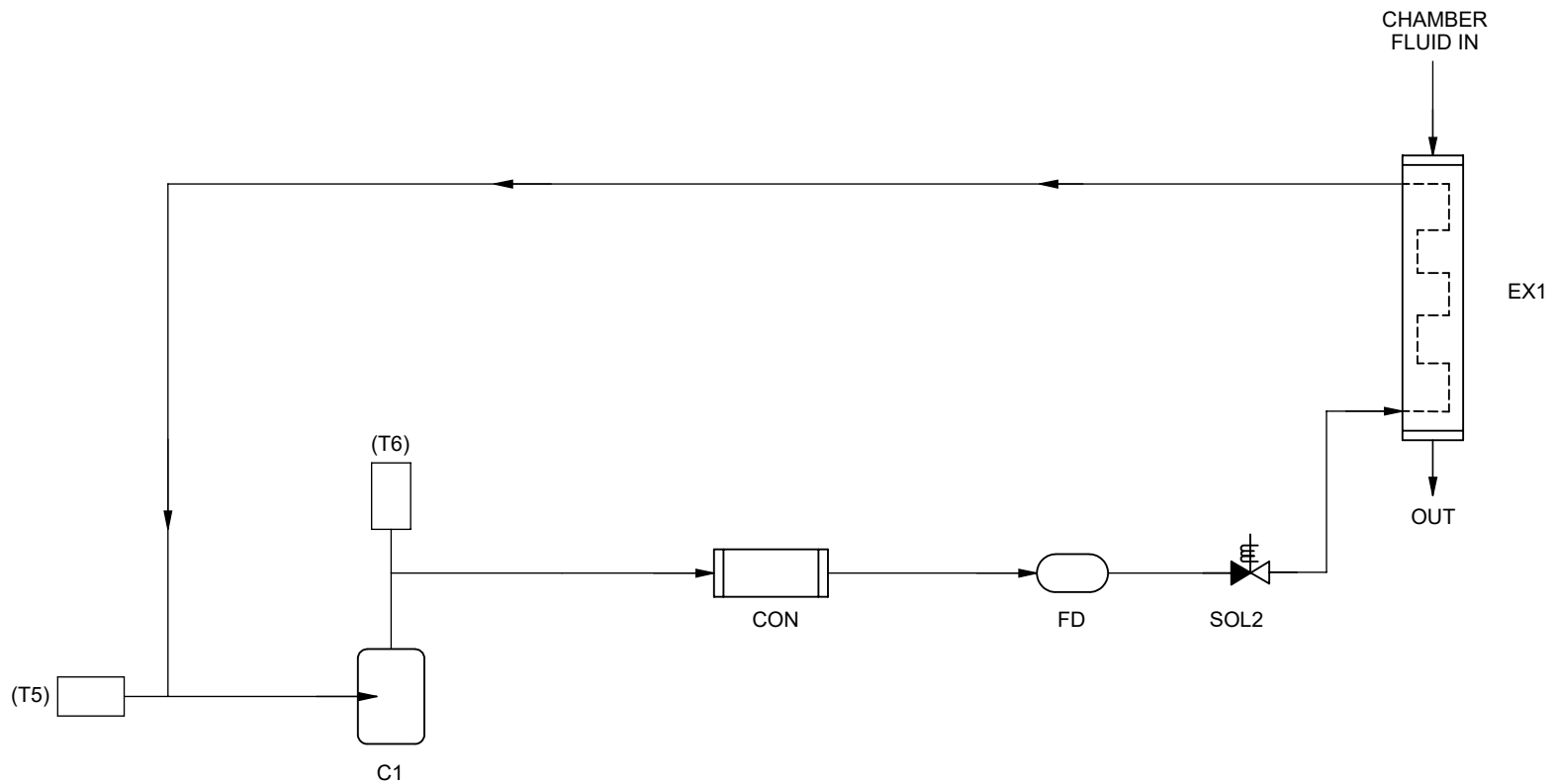

DO NOT SCALE FROM DRAWING		THIRD ANGLE PROJECTION 	PROPRIETARY NOTICE THIS DRAWING AND INFORMATION CONTAINED WITHIN IS PROPRIETARY TO THUNDER SCIENTIFIC AND CANNOT BE COPIED OR REPRODUCED WITHOUT SPECIFIC WRITTEN PERMISSION			Thunder Scientific Corporation 623 Wyoming S.E. Albuquerque, NM 87123		
						Refrigeration Schematic		
		TOLERANCES .XXX ±.010 .XX ±.015 ∠ ±.50° UNLESS NOTED OTHERWISE	DRAWN FURRY 08/05/2018	SIZE A	DWG. NO. 18D29901		REV A	
NEXT ASSY	USED ON		APPROVED BB 08/21/2018		WT. 267.45			
APPLICATION			ISSUED DWF 8/21/2018		SHEET 7 OF 11			

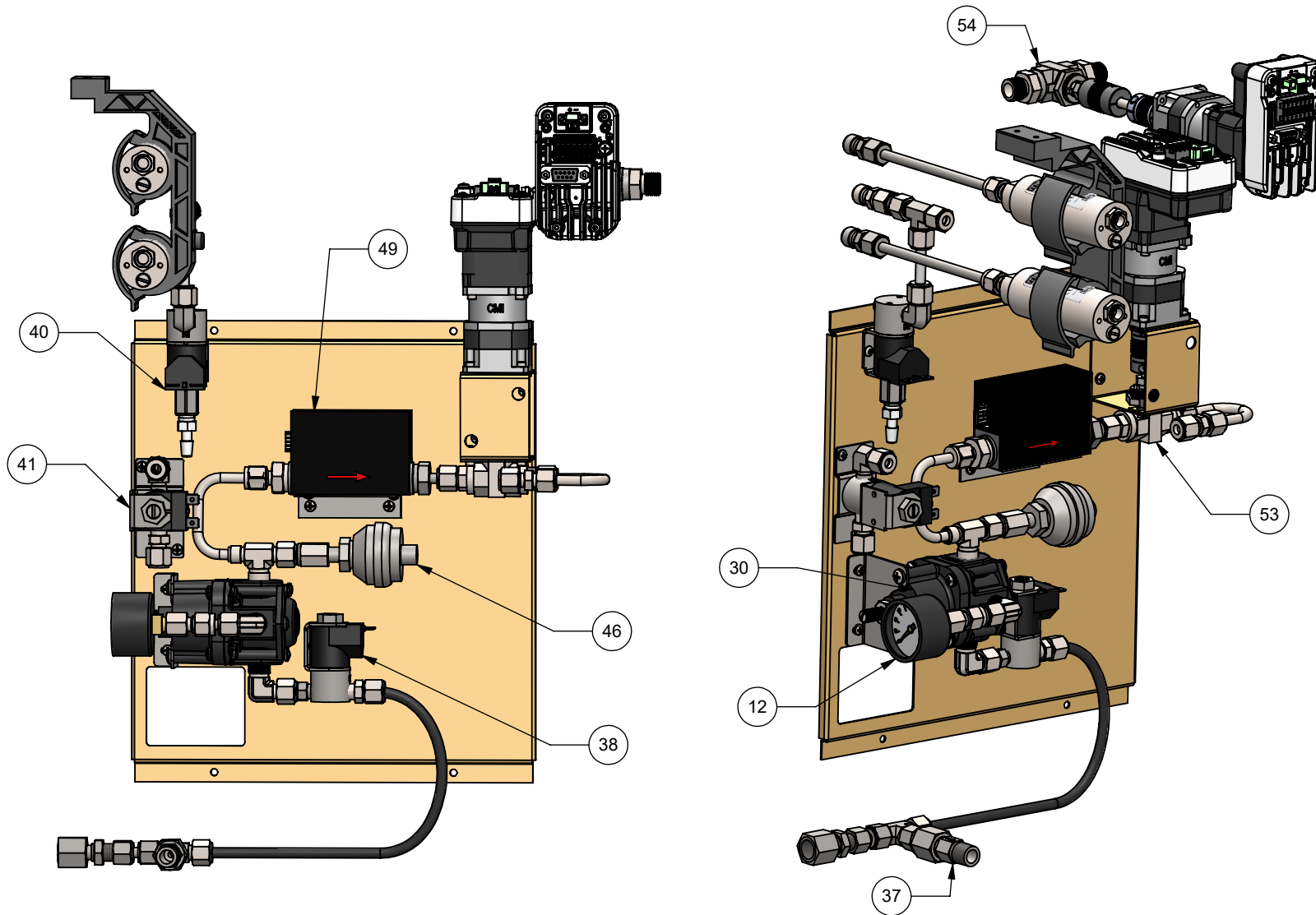

DO NOT SCALE FROM DRAWING		THIRD ANGLE PROJECTION 	PROPRIETARY NOTICE THIS DRAWING AND INFORMATION CONTAINED WITHIN IS PROPRIETARY TO THUNDER SCIENTIFIC AND CANNOT BE COPIED OR REPRODUCED WITHOUT SPECIFIC WRITTEN PERMISSION			Thunder Scientific Corporation 623 Wyoming S.E. Albuquerque, NM 87123		
NEXT ASSY	USED ON		TOLERANCES .XXX ±.010 .XX ±.015 ∠ ±.50° UNLESS NOTED OTHERWISE			DRAWN FURRY 08/05/2018	Pneumatic Components	
APPLICATION		APPROVED BB 08/21/2018	ISSUED DWF 8/21/2018	SIZE A	DWG. NO. 18D29901	REV A	WT. 267.45 SHEET 8 OF 11	

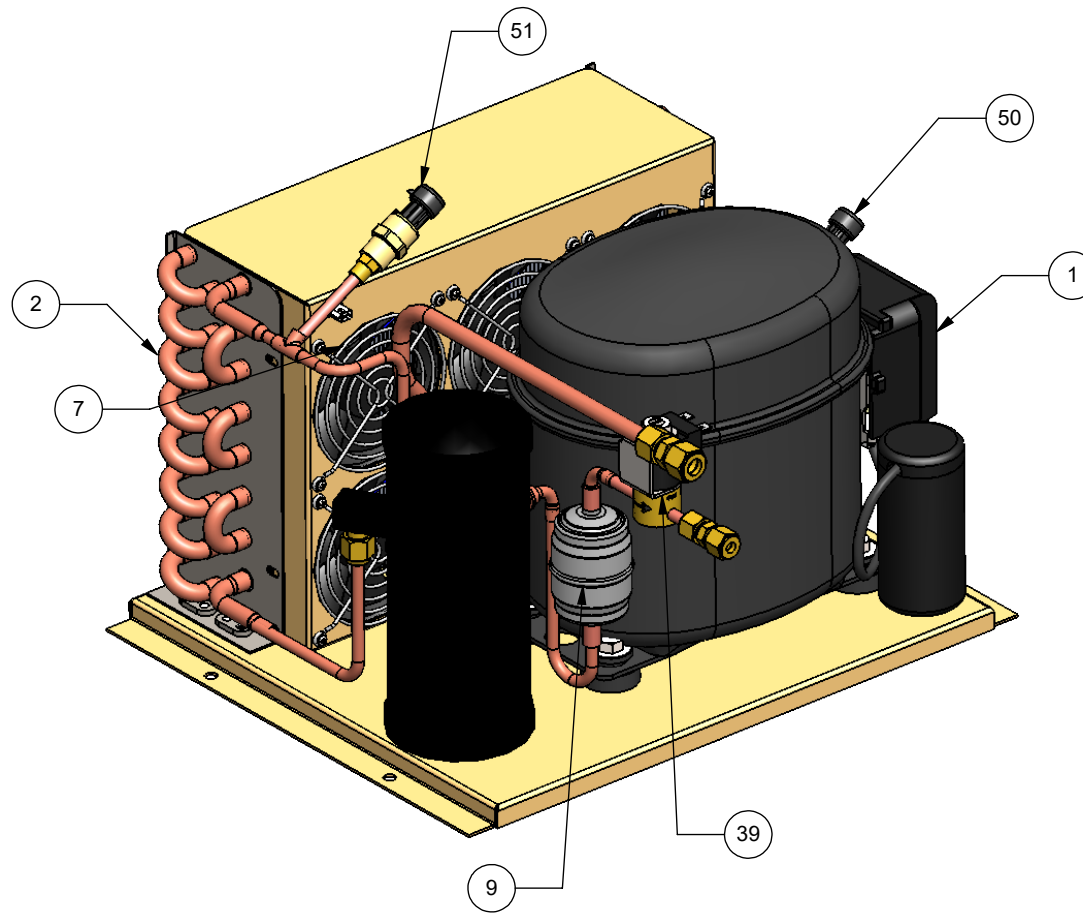

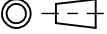
DO NOT SCALE FROM DRAWING		THIRD ANGLE PROJECTION 	PROPRIETARY NOTICE THIS DRAWING AND INFORMATION CONTAINED WITHIN IS PROPRIETARY TO THUNDER SCIENTIFIC AND CANNOT BE COPIED OR REPRODUCED WITHOUT SPECIFIC WRITTEN PERMISSION			Thunder Scientific Corporation 623 Wyoming S.E. Albuquerque, NM 87123		
NEXT ASSY	USED ON		TOLERANCES .XXX ±.010 .XX ±.015 ∠ ±.50° UNLESS NOTED OTHERWISE			DRAWN FURRY 08/05/2018 APPROVED BB 08/21/2018 ISSUED DWF 8/21/2018		Refrigeration Components
APPLICATION					SIZE A	DWG. NO. 18D29901	REV A	WT. 267.45 SHEET 9 OF 11

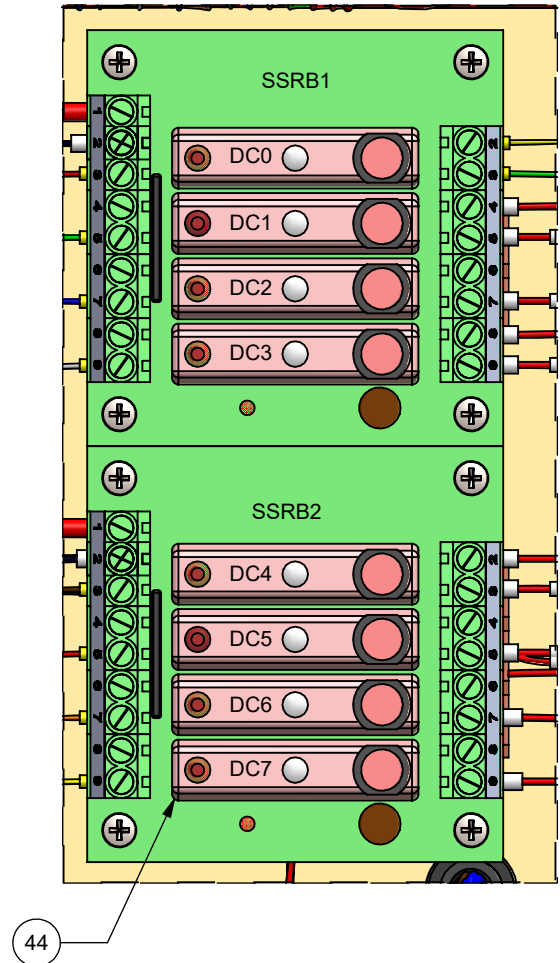
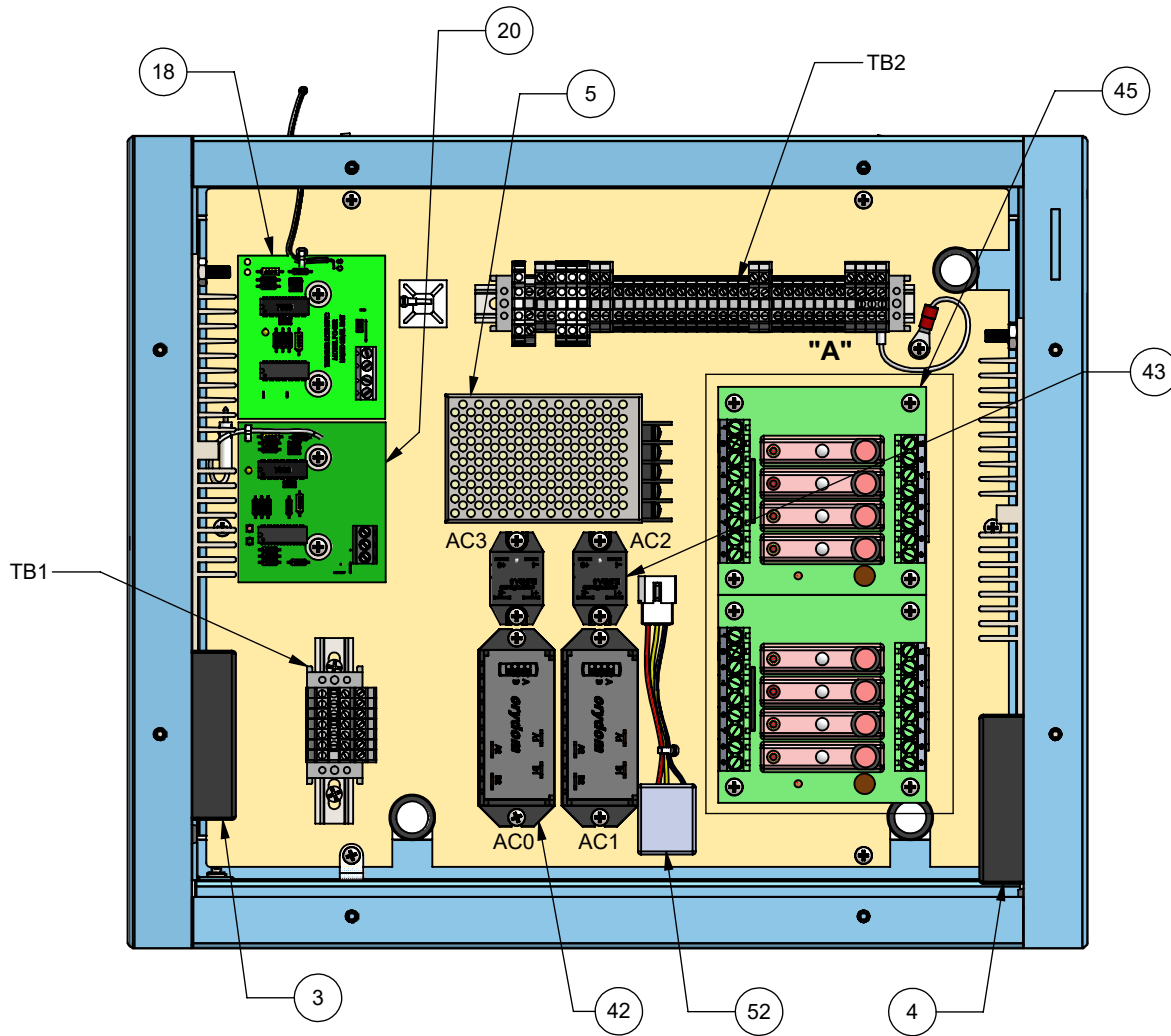

DETAIL "A"

DO NOT SCALE FROM DRAWING		THIRD ANGLE PROJECTION	PROPRIETARY NOTICE THIS DRAWING AND INFORMATION CONTAINED WITHIN IS PROPRIETARY TO THUNDER SCIENTIFIC AND CANNOT BE COPIED OR REPRODUCED WITHOUT SPECIFIC WRITTEN PERMISSION			Thunder Scientific Corporation 623 Wyoming S.E. Albuquerque, NM 87123		
			TOLERANCES .XXX ±.010 .XX ±.015 ∠ ±.50° UNLESS NOTED OTHERWISE			DRAWN FURRY 08/05/2018 APPROVED BB 08/21/2018 ISSUED DWF 8/21/2018	Electrical Components	
NEXT ASSY	USED ON		SIZE A DWG. NO. 18D29901 WT. 267.45	REV A SHEET 10 OF 11				
APPLICATION								

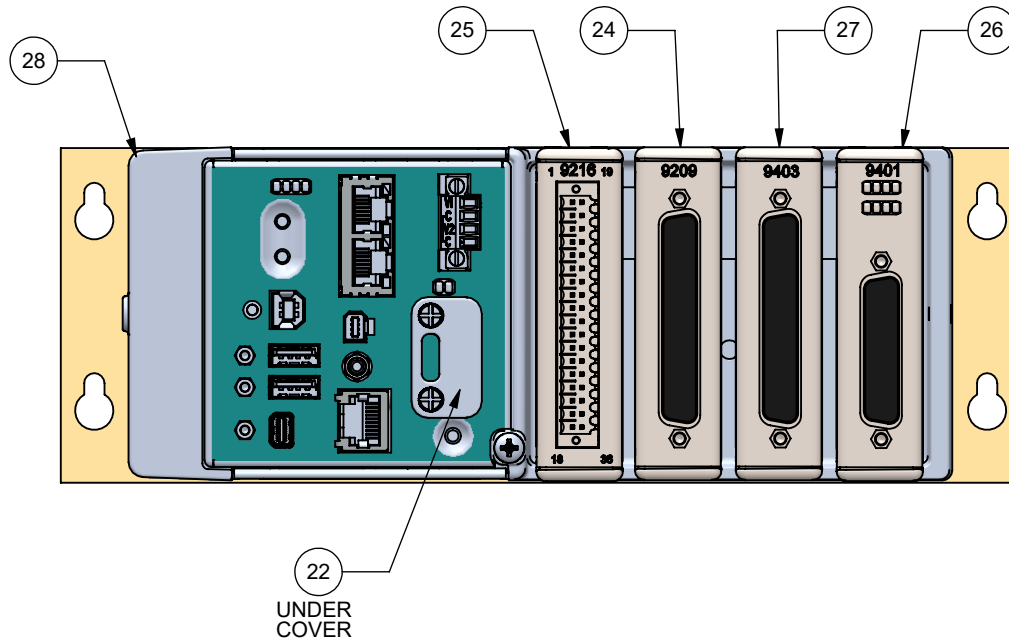

DO NOT SCALE FROM DRAWING		THIRD ANGLE PROJECTION 	PROPRIETARY NOTICE THIS DRAWING AND INFORMATION CONTAINED WITHIN IS PROPRIETARY TO THUNDER SCIENTIFIC AND CANNOT BE COPIED OR REPRODUCED WITHOUT SPECIFIC WRITTEN PERMISSION			Thunder Scientific Corporation 623 Wyoming S.E. Albuquerque, NM 87123		
			TOLERANCES .XXX ±.010 .XX ±.015 ∠ ±.50° UNLESS NOTED OTHERWISE			DRAWN FURRY 08/05/2018	Data Acq. Components	
NEXT ASSY	USED ON		APPROVED BB 08/21/2018	ISSUED DWF 8/21/2018	SIZE A	DWG. NO. 18D29901	REV A	
APPLICATION					WT. 267.45	SHEET 11 OF 11		

REVISIONS				
DWN	REV.	DESCRIPTION	DATE	APP. BY

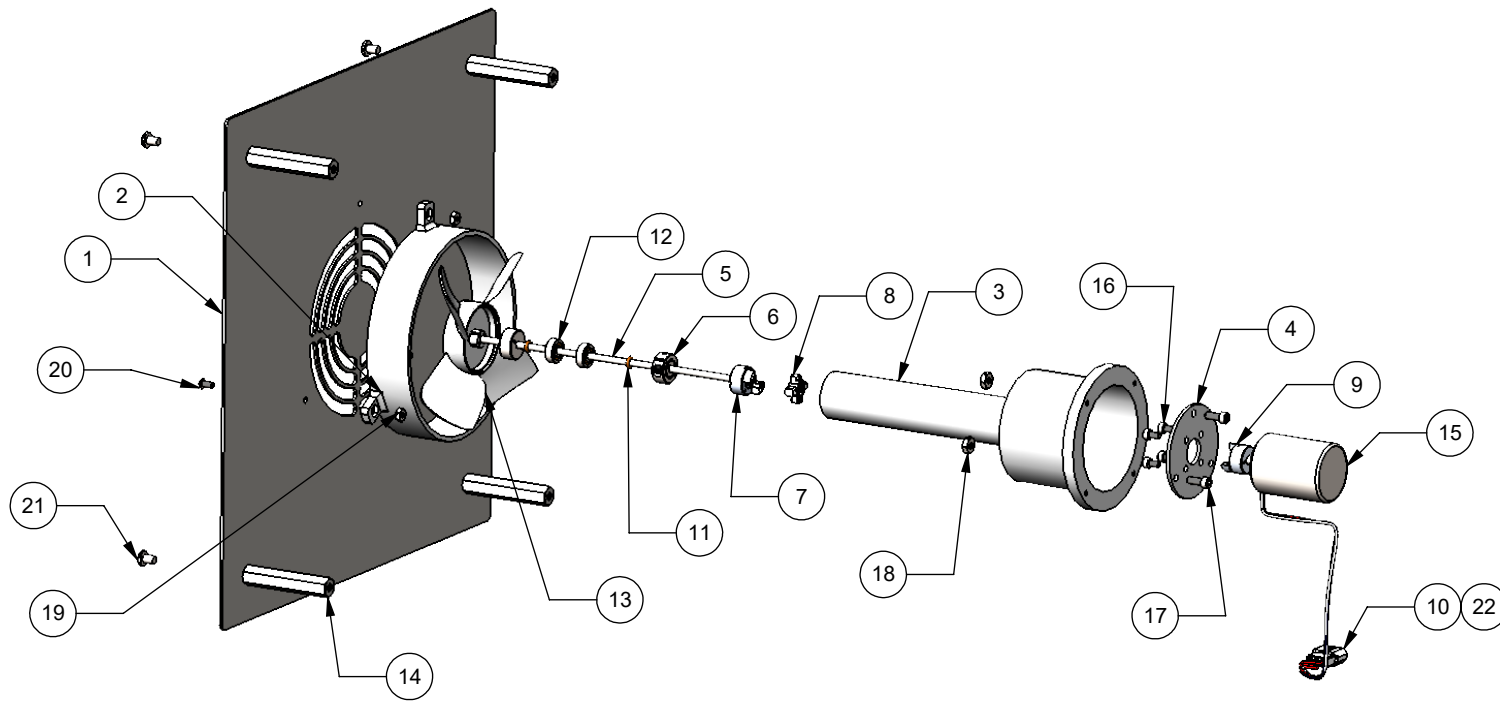

ITEM NO.	TSC STOCKCODE	DESCRIPTION	QTY.	ITEM NO.	TSC STOCKCODE	DESCRIPTION	QTY.
22	** N S I **	.062 MALE CRIMP TERMINAL	3	11	OR006V	1/4" O.D. O RING	2
21	** N S I **	#8-32 X 1/4" PATCHLOK PAN HEAD PHILLIPS SCREW	4	10	MX3-P	Ø .062 3 PIN CRIMP HOUSING	1
20	** N S I **	#4-40 X 1/4" HEX SOCKET HEAD BUTTON SCREW	3	9	MJC15-4-A	4mm JAW COUPLING HUB	1
19	** N S I **	#4-40 HEX NUT	3	8	JD10/15-85B	JAW COUPLING SPIDER	1
18	** N S I **	#6-32 HEX NUT	3	7	JC10-2-A	1/8" JAW COUPLING HUB	1
17	** N S I **	#6-32 X 3/8" SOCKET HEAD CAP SCREW	3	6	CL-2-SS	1/8" SHAFT COLLAR	2
16	** N S I **	M3 X 6 SOCKET HEAD CAP SCREW	4	5	A1-60	PRECISION SHAFT	1
15	4322016-30427	CHAMBER FAN	1	4	D17M29253	FAN MOTOR MOUNTING PLATE	1
14	91115A204	8-32X2.00-STANDOFF	4	3	D17M29252	FAN HOUSING TUBE	1
13	5JLL2	4" FAN BLADE	1	2	D17M29250	4.0" CHAMBER FAN SHROUD	1
12	SR2AC-2OS	.50 X .125 CERAMIC BALL BEARING	2	1	D16M29109	CHAMBER FAN SHROUD PANEL	1

DO NOT SCALE
FROM DRAWING

THIRD ANGLE
PROJECTION

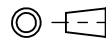

PROPRIETARY NOTICE
THIS DRAWING AND INFORMATION CONTAINED
WITHIN IS PROPRIETARY TO THUNDER SCIENTIFIC
AND CANNOT BE COPIED OR REPRODUCED WITHOUT
SPECIFIC WRITTEN PERMISSION

Thunder Scientific Corporation

623 Wyoming S.E. Albuquerque, NM 87123

Chamber Fan Components

	2900
NEXT ASSY	USED ON
APPLICATION	

TOLERANCES
.XXX ±.010
.XX ±.015
∠ ±.50°
UNLESS NOTED OTHERWISE

DRAWN	FURRY	08/17/2018
APPROVED	BB	8/21/2018
ISSUED	DWF	8/21/2018

SIZE A	DWG. NO. 18D29908	REV -
	WT. 3.18	SHEET 1 OF 1

REVISIONS				
DWN	REV.	DESCRIPTION	DATE	APP. BY

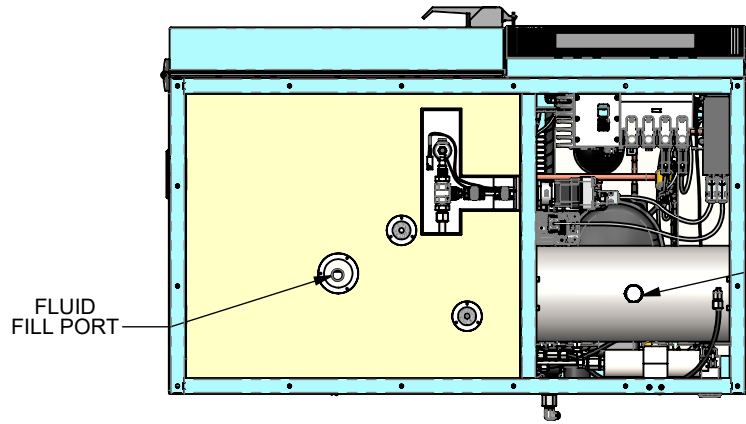

DISTILLED WATER ONLY

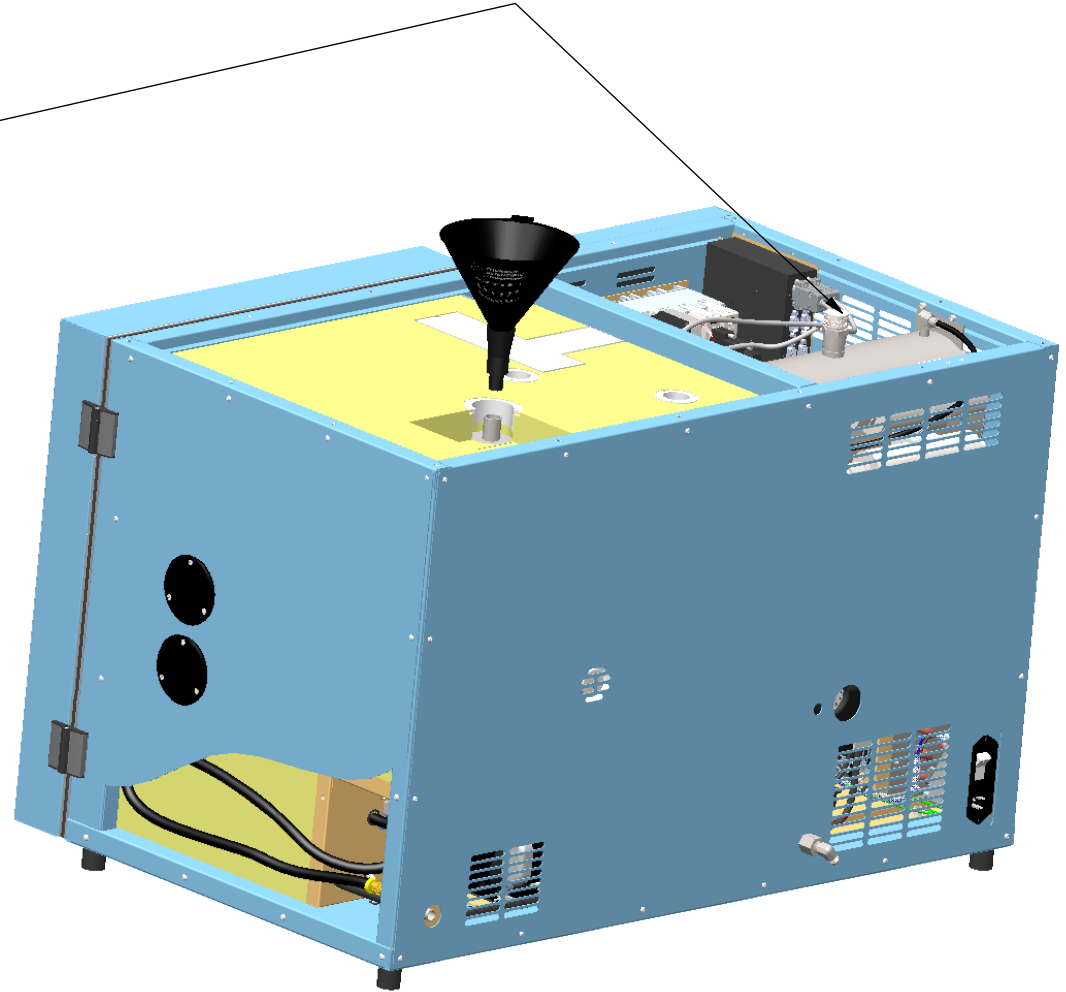

CHAMBER FLUID FILLING REQUIRES:

- T10 TORX DRIVER
- FUNNEL ASSEMBLY
- 2 U.S. GAL. PROPYLENE GLYCOL

CHAMBER FLUID FILLING INSTRUCTIONS

1. REMOVE TOP CONSOLE PANEL AND INSULATION INSERT.
2. LOCATE FILL PORT.
3. REMOVE RED CAP AND INSERT FUNNEL INTO FILL PORT.
4. ADD 2 U.S. GALLONS OF PROPYLENE GLYCOL THEN ADD WATER UNTIL LEVEL IS APPROXIMATELY 1" BELOW BOTTOM OF FILL PORT, OR TO BOTTOM OF FUNNEL NOZZLE.
5. REMOVE FUNNEL AND REPLACE RED CAP.
6. REPLACE INSULATION INSERT AND TOP CONSOLE PANEL.

DO NOT SCALE FROM DRAWING		THIRD ANGLE PROJECTION 	PROPRIETARY NOTICE THIS DRAWING AND INFORMATION CONTAINED WITHIN IS PROPRIETARY TO THUNDER SCIENTIFIC AND CANNOT BE COPIED OR REPRODUCED WITHOUT SPECIFIC WRITTEN PERMISSION			Thunder Scientific Corporation 623 Wyoming S.E. Albuquerque, NM 87123		
NEXT ASSY	USED ON		TOLERANCES .XXX ±.010 .XX ±.015 ∠ ±.50° UNLESS NOTED OTHERWISE			DRAWN FURRY 07/26/2018 APPROVED BB 07/26/2018 ISSUED DWF 07/26/2018	Fluid Fill / Drain Instructions	
APPLICATION		SIZE A	DWG. NO. 18D29909	WT. 279.19		REV -	SHEET 1 OF 2	

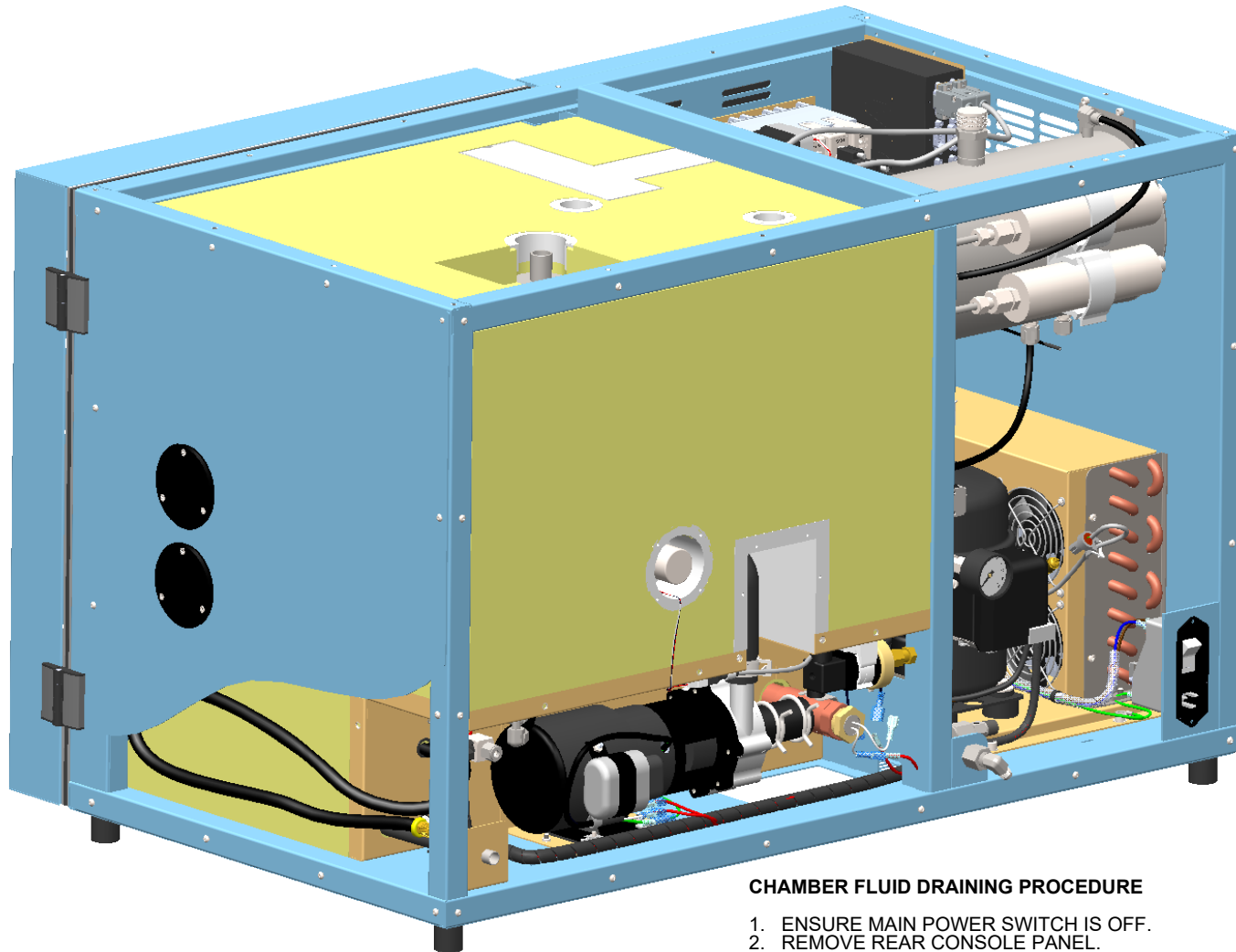

CHAMBER FLUID DRAINING PROCEDURE

1. ENSURE MAIN POWER SWITCH IS OFF.
2. REMOVE REAR CONSOLE PANEL.
3. LOCATE DRAIN HOSE IN THE LOWER LEFT REAR CORNER OF THE GENERATOR (WHEN LOOKING AT THE BACK OF THE GENERATOR).
4. EXTEND AND ELEVATE HOSE, REMOVE DRAIN HOSE CAP AND EMPTY THE CHAMBER FLUID INTO A CLEAN CONTAINER WITH A MINIMUM SIZE OF 4 GALLONS. SAVE THE CHAMBER FLUID FOR REFILLING.
5. TO RESTORE HOSE: GRASP HOSE AND ROTATE COUNTER CLOCKWISE 1/2 TURN WHILE PUSHING HOSE INTO LEFT SIDE STORAGE CAVITY. REPLACE REAR CONSOLE PANEL.

DO NOT SCALE FROM DRAWING		THIRD ANGLE PROJECTION	PROPRIETARY NOTICE THIS DRAWING AND INFORMATION CONTAINED WITHIN IS PROPRIETARY TO THUNDER SCIENTIFIC AND CANNOT BE COPIED OR REPRODUCED WITHOUT SPECIFIC WRITTEN PERMISSION			Thunder Scientific Corporation 623 Wyoming S.E. Albuquerque, NM 87123		
			TOLERANCES .XXX ±.010 .XX ±.015 ∠ ±.50° UNLESS NOTED OTHERWISE			DRAWN FURRY 07/26/2018 APPROVED BB 07/26/2018 ISSUED DWF 07/26/2018		Fluid Fill / Drain Instructions
NEXT ASSY	USED ON				SIZE	DWG. NO.	REV	
APPLICATION					A	18D29909	-	
					WT. 279.19		SHEET 2 OF 2	

REVISIONS				
DWN	REV.	DESCRIPTION	DATE	APP. BY

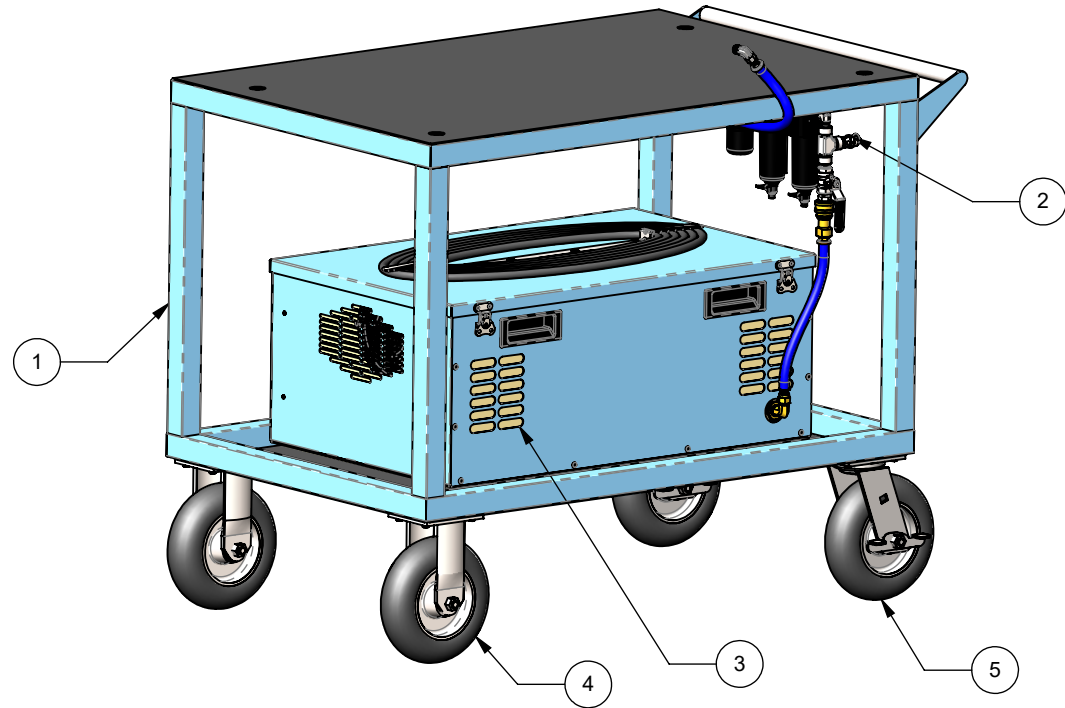
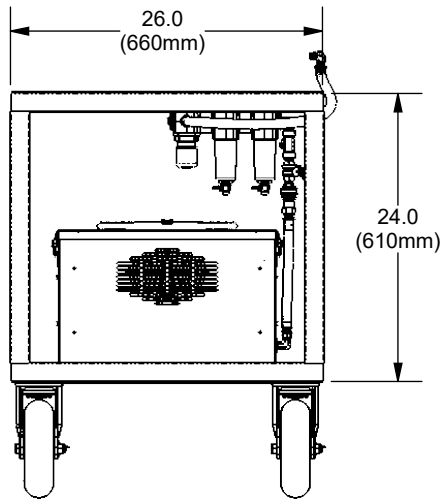
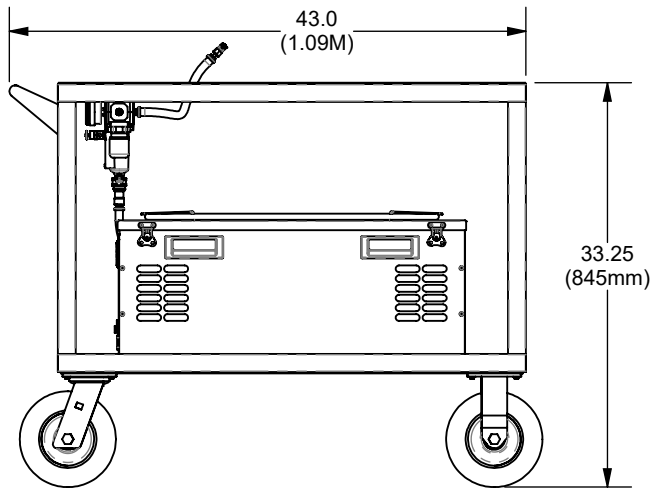

PART NUMBERS
APPLICABLE TO
THIS PAGE ONLY

ITEM NO.	TSC STOCKCODE	DESCRIPTION	MATERIAL SPEC	QTY.
5	BTCASWVL	8" SWIVEL CASTER W/ BRAKE		2
4	BTCASFX	8" FIXED CASTER		2
3	DACS2520-230	AIR BOX ASSEMBLY		1
2	D18A29035	2900 FILTER / REGULATOR ASSEMBLY		1
1	D18A29003	2900 CART ASSEMBLY		1

DO NOT SCALE FROM DRAWING		THIRD ANGLE PROJECTION	PROPRIETARY NOTICE THIS DRAWING AND INFORMATION CONTAINED WITHIN IS PROPRIETARY TO THUNDER SCIENTIFIC AND CANNOT BE COPIED OR REPRODUCED WITHOUT SPECIFIC WRITTEN PERMISSION		Thunder Scientific Corporation 623 Wyoming S.E. Albuquerque, NM 87123		
					Cart / ACS Assembly		
NEXT ASSY		TOLERANCES .XXX ±.010 .XX ±.015 < ±.50° UNLESS NOTED OTHERWISE		DRAWN FURRY 07/25/2018 APPROVED BB 8/21/2018 ISSUED DWF 8/21/2018	SIZE A	DWG. NO. 18D29910	REV -
APPLICATION					WT. 339.07	SHEET 1 OF 3	

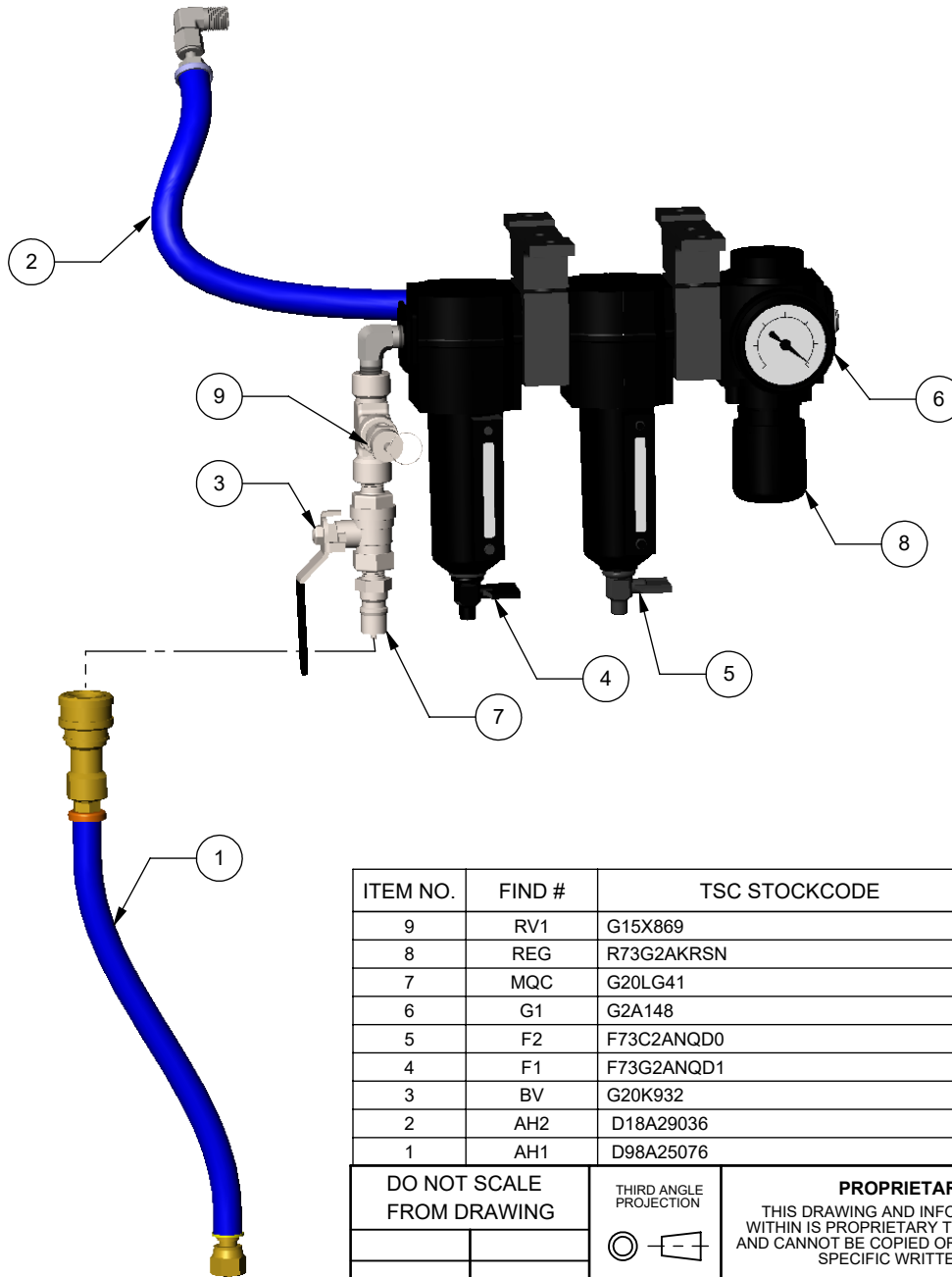

PART NUMBERS
APPLICABLE TO
THIS PAGE ONLY

ITEM NO.	FIND #	TSC STOCKCODE	DESCRIPTION	QTY.
9	RV1	G15X869	200 PSIG AIR RELIEF VALVE (1/4" NPT)	1
8	REG	R73G2AKRSN	AIR REGULATOR	1
7	MQC	G20LG41	QUICK CONNECT COUPLING PLUG	1
6	G1	G2A148	200 PSI GAUGE -1/4" NPT REAR CONNECTION	1
5	F2	F73C2ANQD0	1/4" OIL REMOVAL FILTER	1
4	F1	F73G2ANQD1	1/4" GENERAL PURPOSE FILTER	1
3	BV	G20K932	1/4" FNPT X MNPT BALL VALVE	1
2	AH2	D18A29036	REGULATOR HOSE ASSEMBLY	1
1	AH1	D98A25076	ACS - AIR TANK HOSE ASSEMBLY	1

DO NOT SCALE FROM DRAWING		THIRD ANGLE PROJECTION 	PROPRIETARY NOTICE THIS DRAWING AND INFORMATION CONTAINED WITHIN IS PROPRIETARY TO THUNDER SCIENTIFIC AND CANNOT BE COPIED OR REPRODUCED WITHOUT SPECIFIC WRITTEN PERMISSION		Thunder Scientific Corporation 623 Wyoming S.E. Albuquerque, NM 87123			
		TOLERANCES .XXX ±.010 .XX ±.015 ∠ ±.50° UNLESS NOTED OTHERWISE	DRAWN FURRY 07/25/2018 APPROVED BB 8/21/2018 ISSUED DWF 8/21/2018	Filter / Regulator Assembly		SIZE A	DWG. NO. 18D29910	REV -
NEXT ASSY	USED ON		APPLICATION	WT. 339.07		SHEET 2 OF 3		

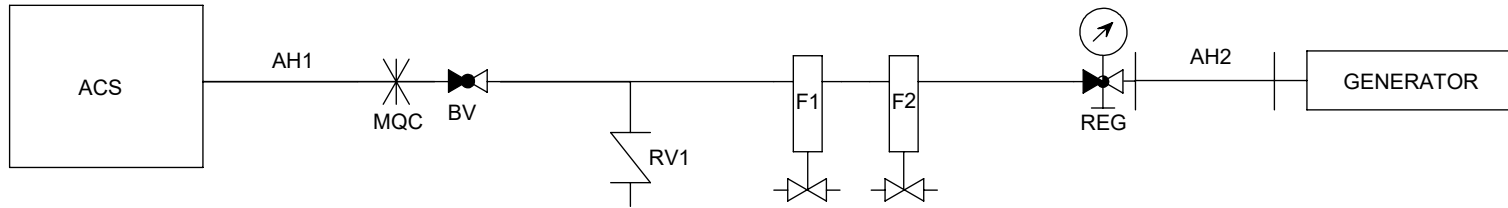

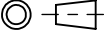
DO NOT SCALE FROM DRAWING		THIRD ANGLE PROJECTION 	PROPRIETARY NOTICE THIS DRAWING AND INFORMATION CONTAINED WITHIN IS PROPRIETARY TO THUNDER SCIENTIFIC AND CANNOT BE COPIED OR REPRODUCED WITHOUT SPECIFIC WRITTEN PERMISSION			Thunder Scientific Corporation 623 Wyoming S.E. Albuquerque, NM 87123		
						Cart Pneumatic System Schematic		
NEXT ASSY	USED ON	TOLERANCES .XXX ±.010 .XX ±.015 ∠ ±.50° UNLESS NOTED OTHERWISE	DRAWN	FURRY	07/25/2018	SIZE	DWG. NO.	REV
			APPROVED	BB	8/21/2018	A	18D29910	-
APPLICATION			ISSUED	DWF	8/21/2018			

REVISIONS				
DWN	REV.	DESCRIPTION	DATE	APP. BY
DWF	A	ADD TIMER (TR5) TO 12 VDC SIDE OF DC3	6/24/2020	BB

POWER (PEM)

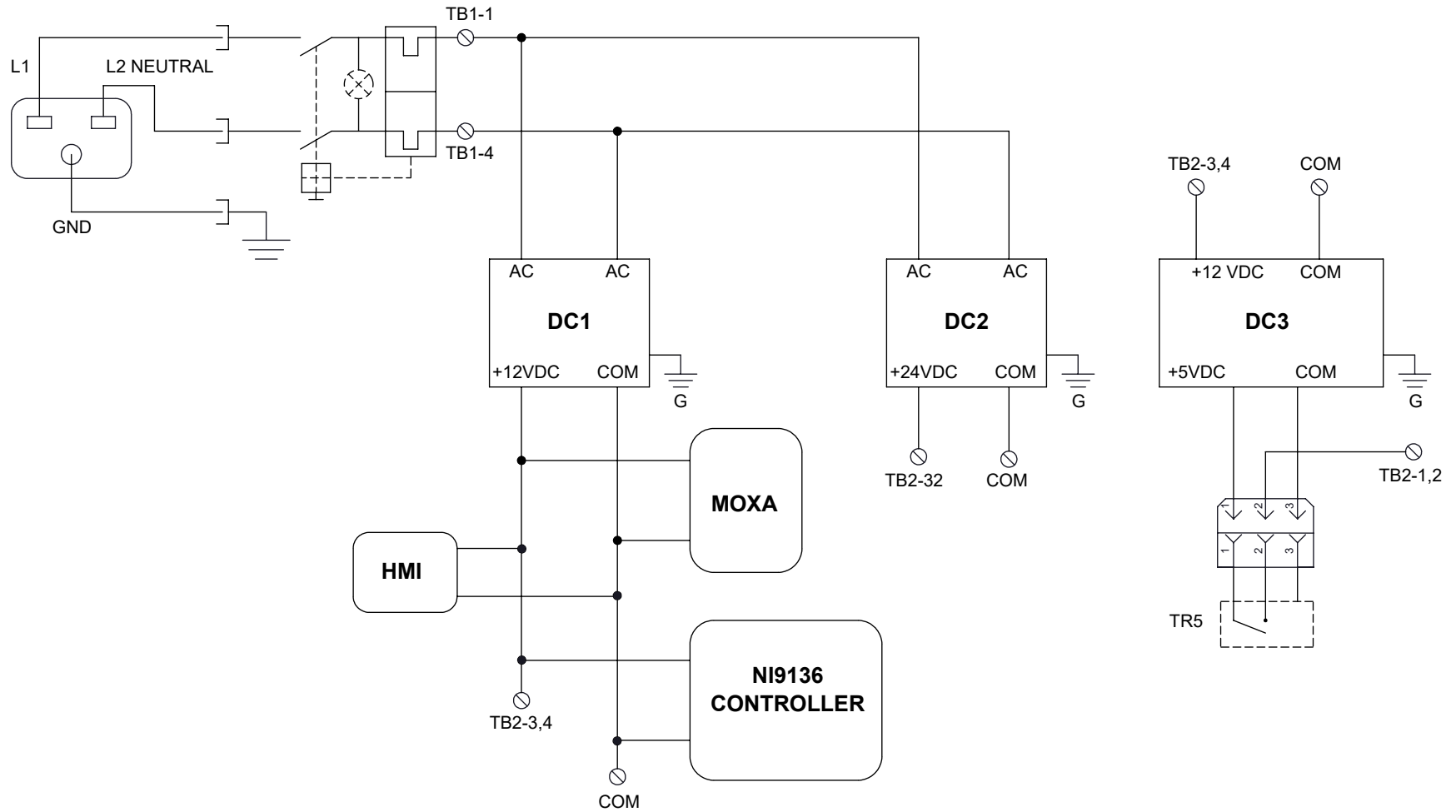

- TB1 - 7 GND
- TB1 - 1-3 L1 (208/240 VAC)
- TB1 - 4-6 L2 (NEUTRAL)
- TB2 - 1,2 +5 VDC
- TB2 - 3,4 +12 VDC
- TB2 - 32 +24 VDC
- TB2 - 5-7,24,33-35 COMMON

DO NOT SCALE FROM DRAWING		THIRD ANGLE PROJECTION	PROPRIETARY NOTICE THIS DRAWING AND INFORMATION CONTAINED WITHIN IS PROPRIETARY TO THUNDER SCIENTIFIC AND CANNOT BE COPIED OR REPRODUCED WITHOUT SPECIFIC WRITTEN PERMISSION			Thunder Scientific Corporation 623 Wyoming S.E. Albuquerque, NM 87123		
			TOLERANCES .XXX ±.010 .XX ±.015 ∠ ±.50° UNLESS NOTED OTHERWISE			AC / DC Power Distribution		
NEXT ASSY USED ON		2900	DRAWN	FURRY	7/12/2018	SIZE A	DWG. NO.	REV
APPLICATION			APPROVED	BB	08/21/2018		18S29911	A
			ISSUED	DWF	8/21/2018	WT. N / A		SHEET 1 OF 1

REVISIONS				
DWN	REV.	DESCRIPTION	DATE	APP. BY

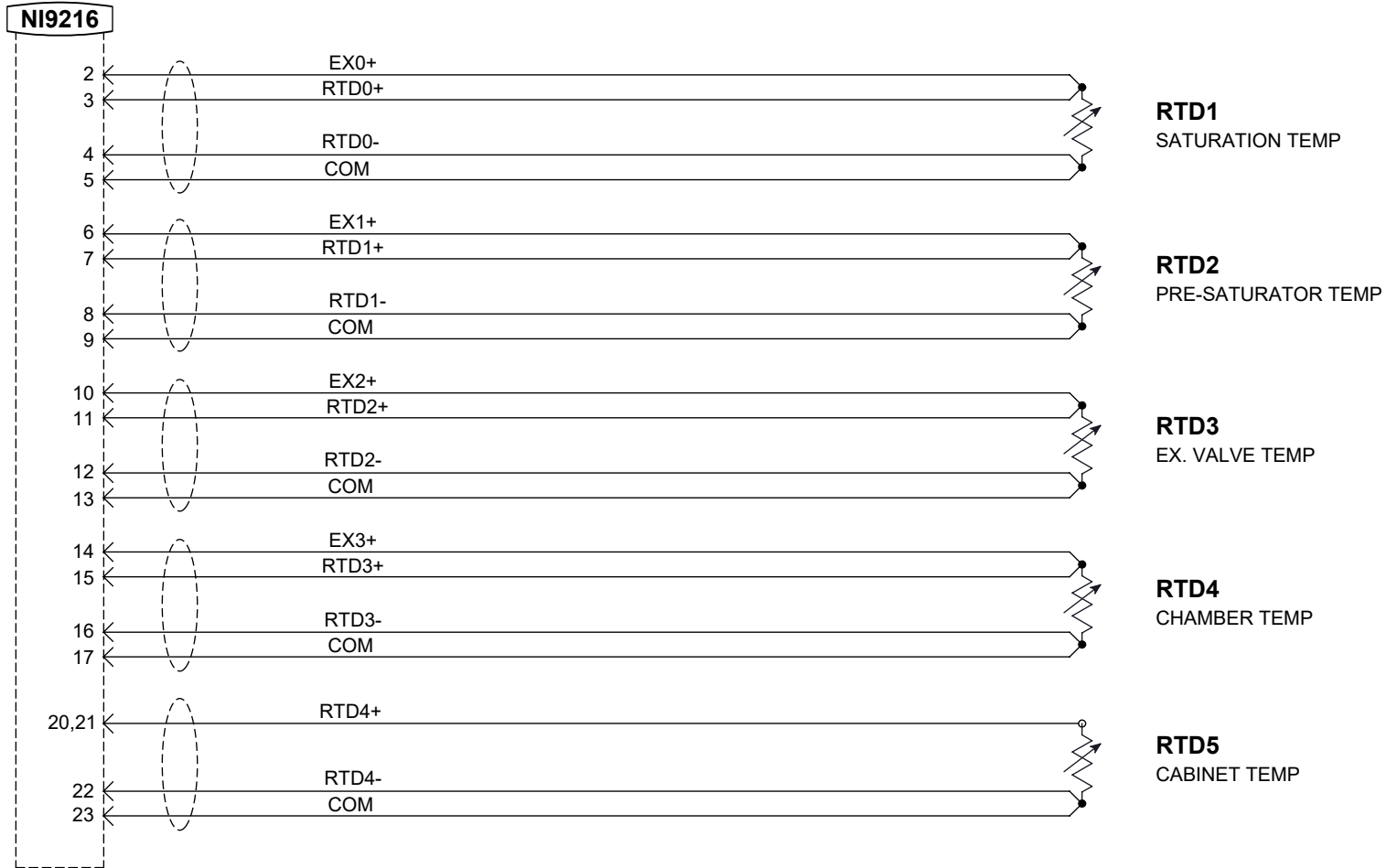

DO NOT SCALE FROM DRAWING		THIRD ANGLE PROJECTION	PROPRIETARY NOTICE THIS DRAWING AND INFORMATION CONTAINED WITHIN IS PROPRIETARY TO THUNDER SCIENTIFIC AND CANNOT BE COPIED OR REPRODUCED WITHOUT SPECIFIC WRITTEN PERMISSION			Thunder Scientific Corporation 623 Wyoming S.E. Albuquerque, NM 87123		
						Temperature Probe Schematic		
		TOLERANCES .XXX ±.010 .XX ±.015 ∠ ±.50° UNLESS NOTED OTHERWISE	DRAWN FURRY 7/12/2018 APPROVED BB 8/21/2018 ISSUED DWF 8/21/2018	SIZE A WT. N/A	DWG. NO. 18S29912	REV -	SHEET 1 OF 1	
NEXT ASSY	USED ON	APPLICATION						

REVISIONS				
DWN	REV.	DESCRIPTION	DATE	APP. BY

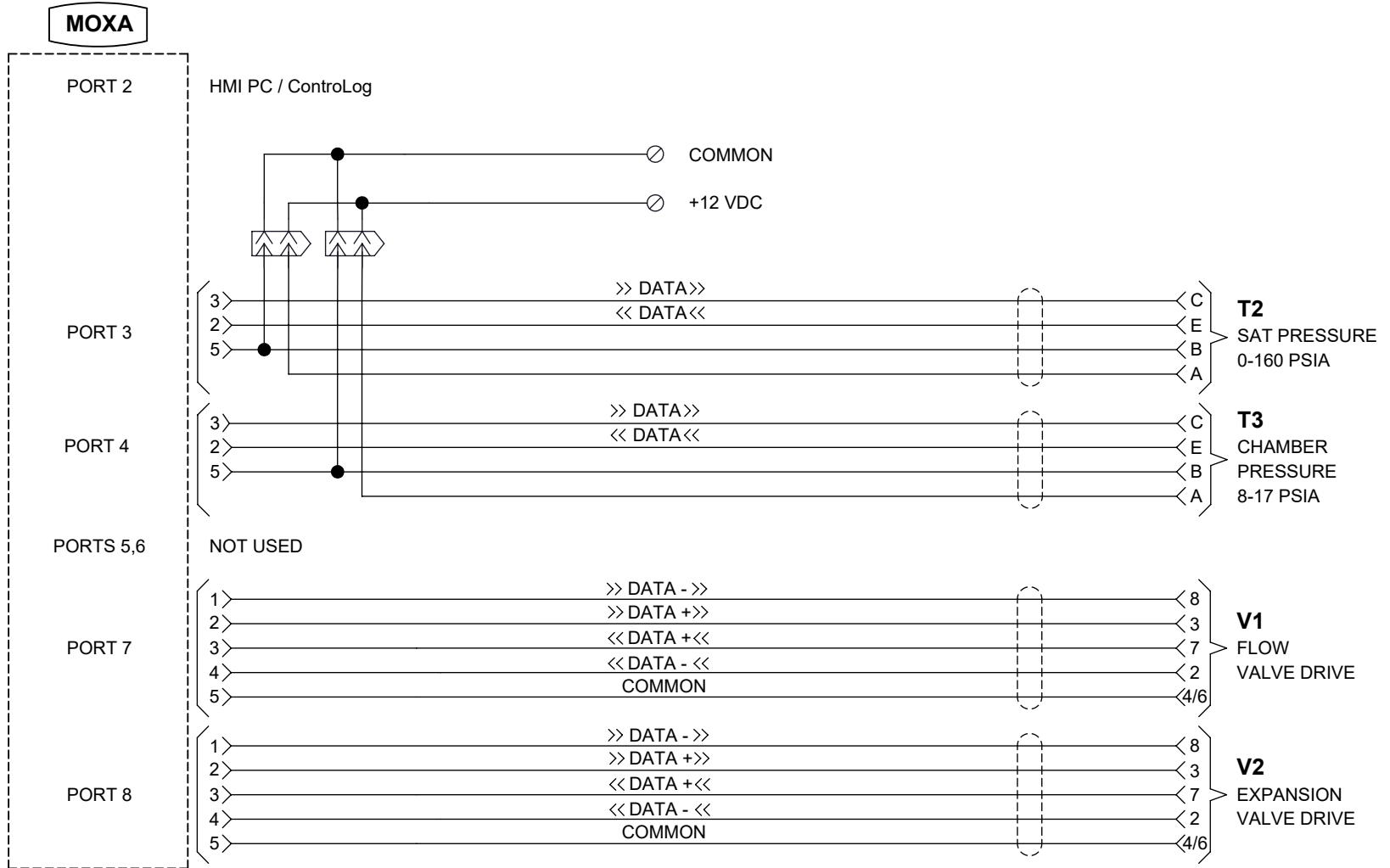

TB2 - 3,4 +12 VDC
TB2 - 5-7,24,33-35 COMMON

DO NOT SCALE FROM DRAWING		THIRD ANGLE PROJECTION	PROPRIETARY NOTICE THIS DRAWING AND INFORMATION CONTAINED WITHIN IS PROPRIETARY TO THUNDER SCIENTIFIC AND CANNOT BE COPIED OR REPRODUCED WITHOUT SPECIFIC WRITTEN PERMISSION		Thunder Scientific Corporation 623 Wyoming S.E. Albuquerque, NM 87123		
					Pres Tran/Stepper Drive Schematic		
		TOLERANCES .XXX ±.010 .XX ±.015 < ±.50° UNLESS NOTED OTHERWISE		DRAWN FURRY APPROVED BB ISSUED DWF	5/27/2016 8/21/2018 8/21/2018	SIZE A DWG. NO. 18S29913 WT. N/A	REV - SHEET 1 OF 1
NEXT ASSY	USED ON	APPLICATION					

REVISIONS				
DWN	REV.	DESCRIPTION	DATE	APP. BY

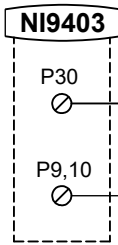

LL2
PRE SAT LEVEL

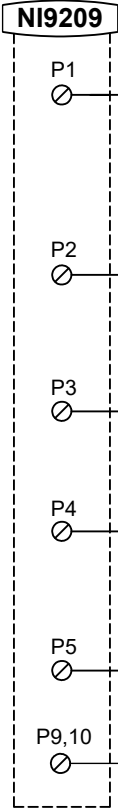

LL1
RESERVOIR LEVEL

T1
SUPPLY PRESSURE

T4
MASS FLOW

T5
REFRIG LOW-SIDE PRESSURE

T6
REFRIG HIGH-SIDE PRESSURE

P20 - P24 ARE STRAPPED TO P28

TB2 - 1,2 +5 VDC
TB2 - 3,4 +12 VDC
TB2 - 5-7,24,33-35 COMMON

DO NOT SCALE FROM DRAWING		THIRD ANGLE PROJECTION	PROPRIETARY NOTICE THIS DRAWING AND INFORMATION CONTAINED WITHIN IS PROPRIETARY TO THUNDER SCIENTIFIC AND CANNOT BE COPIED OR REPRODUCED WITHOUT SPECIFIC WRITTEN PERMISSION			Thunder Scientific Corporation 623 Wyoming S.E. Albuquerque, NM 87123			
NEXT ASSY		USED ON	TOLERANCES .XXX ±.010 .XX ±.015 ∠ ±.50° UNLESS NOTED OTHERWISE			DRAWN FURRY 5/12/2018 APPROVED BB 8/21/2018 ISSUED DWF 8/21/2018		Transducer Schematic	
APPLICATION			SIZE A DWG. NO. 18S29914 WT. N/A			REV - SHEET 1 OF 1			

REVISIONS				
DWN	REV.	DESCRIPTION	DATE	APP. BY

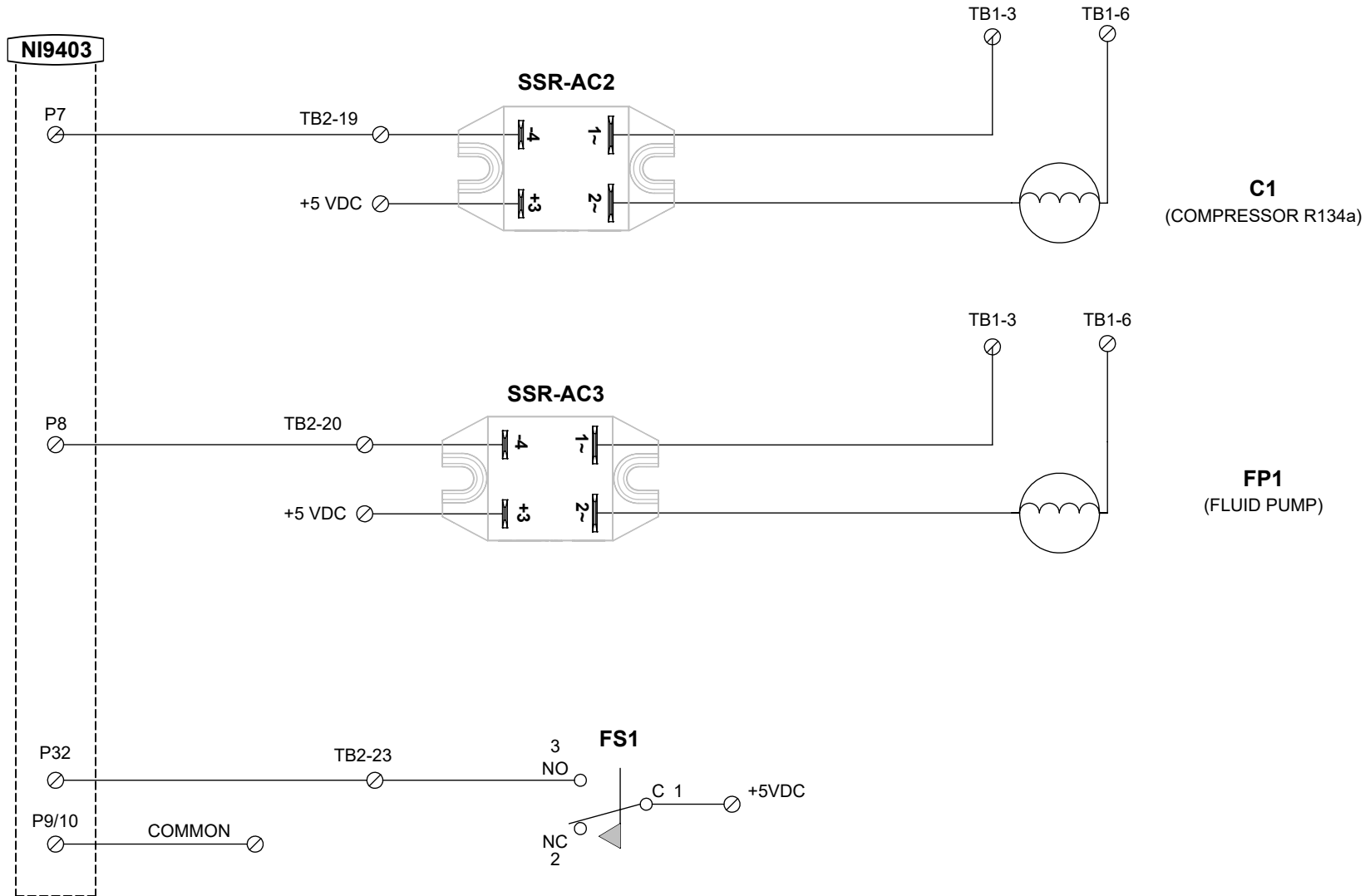

TB1 - 1-3 L1 (208/240 VAC)
 TB1 - 4-6 L2 (NEUTRAL)
 TB2 - 1,2 +5 VDC
 TB2 - 5-7,24,33-35 COMMON

DO NOT SCALE FROM DRAWING		THIRD ANGLE PROJECTION	PROPRIETARY NOTICE THIS DRAWING AND INFORMATION CONTAINED WITHIN IS PROPRIETARY TO THUNDER SCIENTIFIC AND CANNOT BE COPIED OR REPRODUCED WITHOUT SPECIFIC WRITTEN PERMISSION		Thunder Scientific Corporation 623 Wyoming S.E. Albuquerque, NM 87123	
			TOLERANCES .XXX ±.010 .XX ±.015 < ±.50° UNLESS NOTED OTHERWISE		DRAWN FURRY 7/11/2018 APPROVED BB 8/21/2018 ISSUED DWF 8/21/2018	Pump / Comp / Flow Schematic
NEXT ASSY	USED ON		SIZE A DWG. NO. 18S29915 WT. N/A	REV - SHEET 1 OF 1		

REVISIONS				
DWN	REV.	DESCRIPTION	DATE	APP. BY

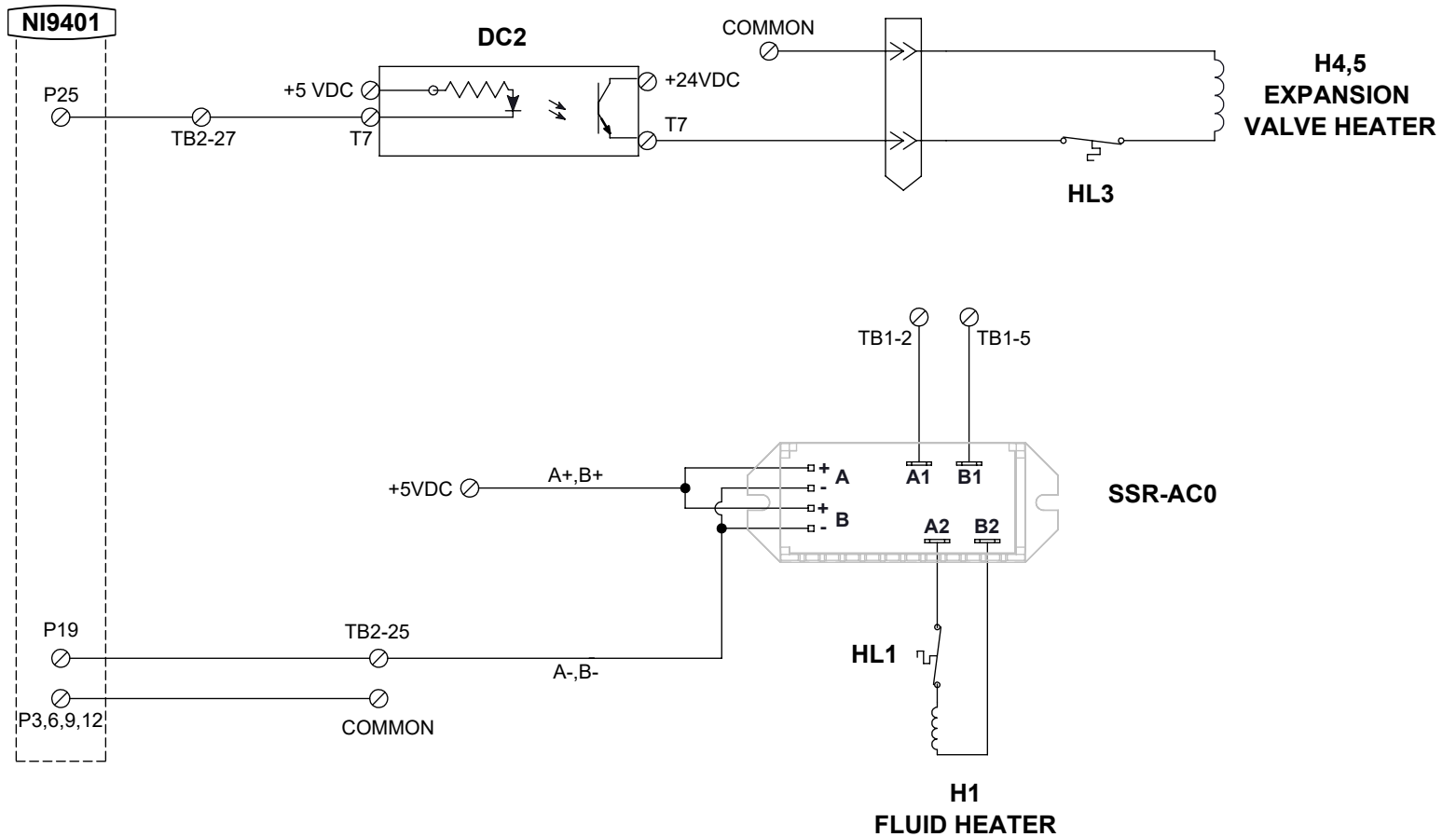

TB1 - 1-3 L1 (208/240 VAC)
 TB1 - 4-6 L2 (NEUTRAL)
 TB2 - 1,2 +5 VDC
 TB2 - 32 +24 VDC
 TB2 - 5-7,24,33-35 COMMON

DO NOT SCALE FROM DRAWING	
NEXT ASSY	USED ON
APPLICATION	

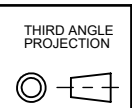

TOLERANCES
 .XXX ±.010
 .XX ±.015
 ∠ ±.50°
 UNLESS NOTED OTHERWISE

PROPRIETARY NOTICE THIS DRAWING AND INFORMATION CONTAINED WITHIN IS PROPRIETARY TO THUNDER SCIENTIFIC AND CANNOT BE COPIED OR REPRODUCED WITHOUT SPECIFIC WRITTEN PERMISSION		
DRAWN	FURRY	7/11/2018
APPROVED	BB	8/21/2018
ISSUED	DWF	8/21/2018

Thunder Scientific Corporation 623 Wyoming S.E. Albuquerque, NM 87123		
Exp. Valve / Fluid Heater Schematic		
SIZE	DWG. NO.	REV
A	18S29916	-
WT. N/A		SHEET 1 OF 1

REVISIONS				
DWN	REV.	DESCRIPTION	DATE	APP. BY

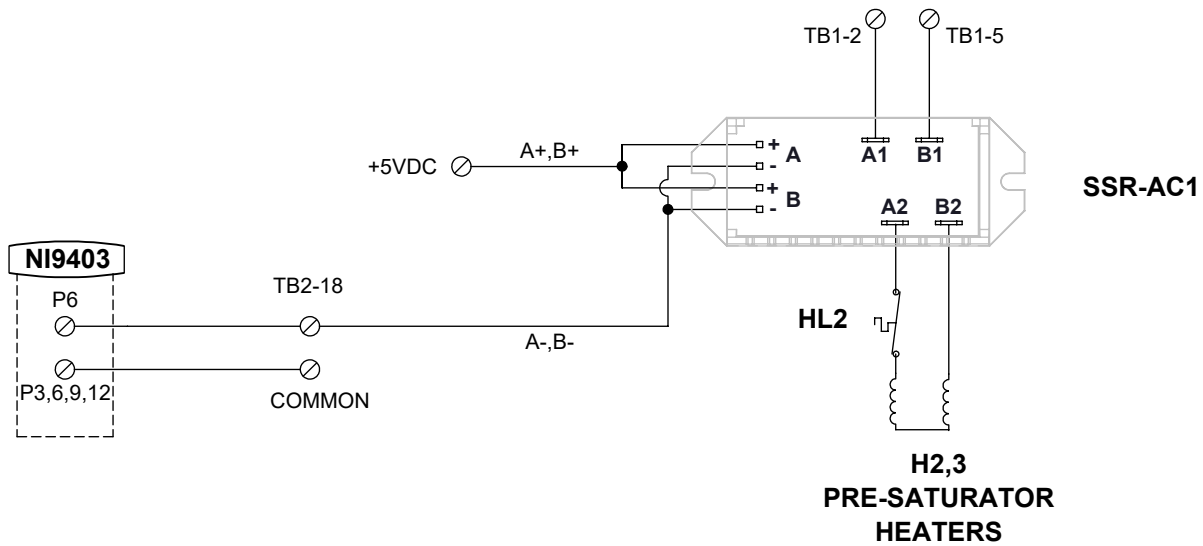

TB1 - 1-3 L1 (208/240 VAC)
 TB1 - 4-6 L2 (NEUTRAL)
 TB2 - 1,2 +5 VDC
 TB2 - 5-7,24,33-35 COMMON

DO NOT SCALE FROM DRAWING		THIRD ANGLE PROJECTION	PROPRIETARY NOTICE THIS DRAWING AND INFORMATION CONTAINED WITHIN IS PROPRIETARY TO THUNDER SCIENTIFIC AND CANNOT BE COPIED OR REPRODUCED WITHOUT SPECIFIC WRITTEN PERMISSION		Thunder Scientific Corporation 623 Wyoming S.E. Albuquerque, NM 87123			
					Pre Saturator Heater Schematic			
NEXT ASSY		USED ON	TOLERANCES .XXX ±.010 .XX ±.015 ∠ ±.50° UNLESS NOTED OTHERWISE		DRAWN FURRY APPROVED BB ISSUED DWF	7/11/2018 8/21/2018 8/21/2018	SIZE A DWG. NO. 18S29917 WT. N/A	REV - SHEET 1 OF 1
APPLICATION								

REVISIONS				
DWN	REV.	DESCRIPTION	DATE	APP. BY

NI9401

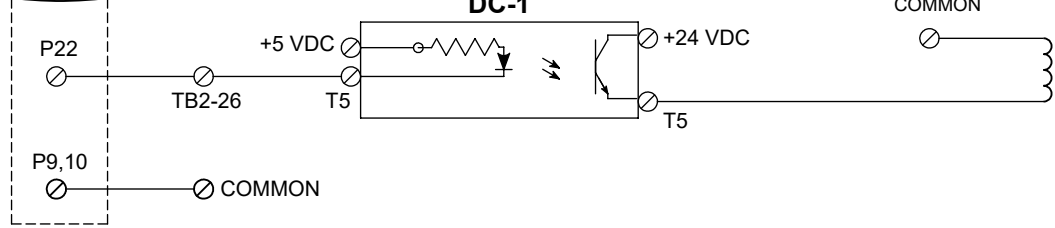

SOL2
FLUID COOL SOLENOID

NI9403

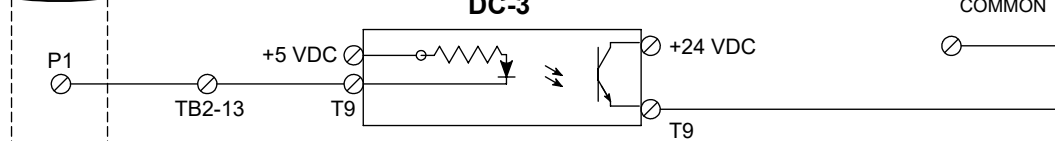

SOL4
PRE SATURATOR FILL SOLENOID

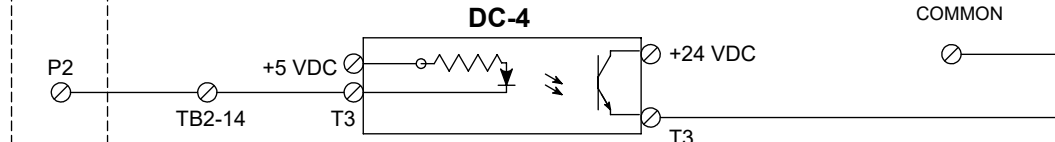

SOL3
PRESSURE VENT SOLENOID

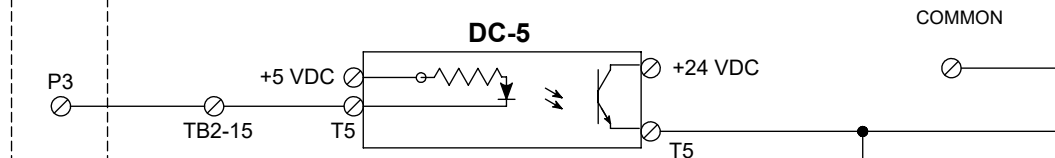

SOL1
AIR / GAS SUPPLY SOLENOID

REMOTE AIR COMPRESSOR CONTROL

TB2 - 1,2 +5 VDC
TB2 - 32 +24 VDC
TB2 - 5-7,24,33-35 COMMON

DO NOT SCALE
FROM DRAWING

THIRD ANGLE
PROJECTION

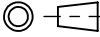

PROPRIETARY NOTICE

THIS DRAWING AND INFORMATION CONTAINED
WITHIN IS PROPRIETARY TO THUNDER SCIENTIFIC
AND CANNOT BE COPIED OR REPRODUCED WITHOUT
SPECIFIC WRITTEN PERMISSION

Thunder Scientific Corporation

623 Wyoming S.E. Albuquerque, NM 87123

Solenoid Valve Control Schematic

TOLERANCES

.XXX ±.010
.XX ±.015
∠ ±.50°

UNLESS NOTED OTHERWISE

DRAWN FURRY 7/11/2018

APPROVED BB 8/21/2018

ISSUED DWF 8/21/2018

SIZE

A

DWG. NO.

18S29918

REV

-

WT. N / A

SHEET 1 OF 1

NEXT ASSY USED ON

APPLICATION

REVISIONS				
DWN	REV.	DESCRIPTION	DATE	APPROVED

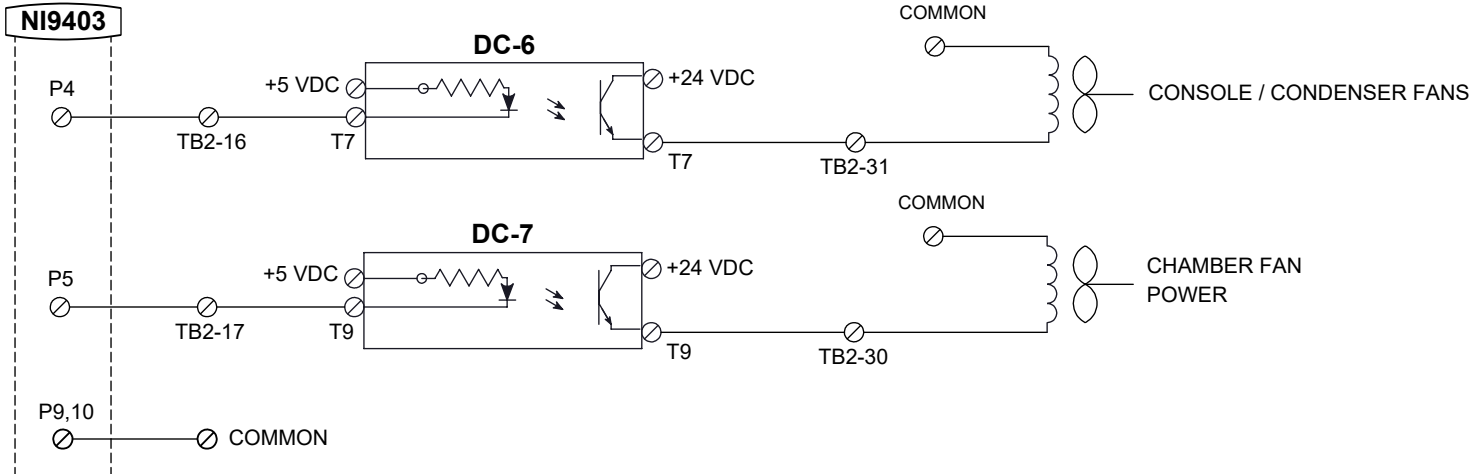
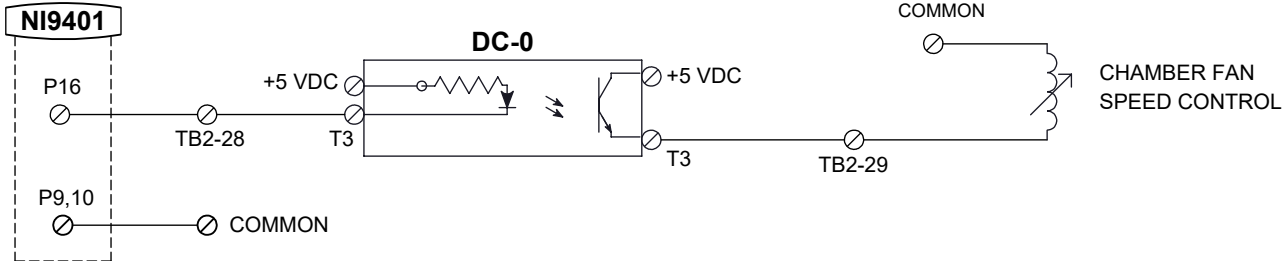

TB2 - 1,2 +5 VDC
 TB2 - 32 +24 VDC
 TB2 - 5-7,24,33-35 COMMON

DO NOT SCALE FROM DRAWING	
NEXT ASSY	USED ON
APPLICATION	

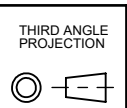

PROPRIETARY NOTICE
 THIS DRAWING AND INFORMATION CONTAINED WITHIN IS PROPRIETARY TO THUNDER SCIENTIFIC AND CANNOT BE COPIED OR REPRODUCED WITHOUT SPECIFIC WRITTEN PERMISSION

TOLERANCES
 .XXX ±.010
 .XX ±.015
 ∠ ±.50°
 UNLESS NOTED OTHERWISE

DRAWN	FURRY	7/11/2018
APPROVED	BB	8/21/2018
ISSUED	DWF	8/21/2018

Thunder Scientific Corporation
 623 Wyoming S.E. Albuquerque, NM 87123

Fan Control Schematic		
SIZE	DWG. NO.	REV
A	18S29919	-
WT. N/A		SHEET 1 OF 1