



800-404-ATEC (2832)



OptiFiber® Pro







OTDR Getting Started Guide

The OptiFiber® Pro Optical Time Domain Reflectometer (OTDR) module attaches to a Versiv™ or Versiv 2 main unit to make a rugged, hand-held tester that lets you locate, identify, and measure reflective and loss events in multimode and singlemode fibers. Typical maximum test ranges are 35 km maximum at 1300 nm for multimode fiber and 130 km maximum at 1550 nm for singlemode fiber.

Accessing the Product Manuals

This guide provides basic information to help you get started using the tester. For more detailed information, see the latest versions of the *Versiv Series Users Manual* and the *Versiv Series Technical Reference Handbook* provided on the Fluke Networks website.









Symbols

	Warning or Caution: Risk of damage or destruction to equipment or software. See explanations in the manuals.
	Warning: Risk of fire, electric shock, or personal injury.
	Warning: Class 1 or Class 2 lasers. Risk of eye damage from hazardous radiation.
	Consult the user documentation.
	Do not connect this equipment to public communications networks, such as telephone systems.
	Conforms to the Appliance Efficiency Regulation (California Code of Regulations, Title 20, Sections 1601 through 1608), for small battery charging systems.



PN 4959156, January 2018

©2018 Fluke Corporation
All product names are trademarks of their respective companies.

 Li-ion	<p>This Product contains a lithium-ion battery. Do not mix with the solid waste stream. Spent batteries should be disposed of by a qualified recycler or hazardous materials handler per local regulations. Contact your authorized Fluke Service Center for recycling information.</p>
	<p>40 year Environment Friendly Use Period (EFUP) under China Regulation - Administrative Measure on the Control of Pollution Caused by Electronic Information Products. This is the period of time before any of the identified hazardous substances are likely to leak out, causing possible harm to health and the environment.</p>
	<p>This product complies with the WEEE Directive marking requirements. The affixed label indicates that you must not discard this electrical/electronic product in domestic household waste. Product Category: With reference to the equipment types in the WEEE Directive Annex I, this product is classed as category 9 "Monitoring and Control Instrumentation" product. Do not dispose of this product as unsorted municipal waste. To return unwanted products, contact the manufacturer's web site shown on the product or your local sales office or distributor.</p>
	<p>Conformite Europeene. Conforms to the requirements of the European Union and the European Free Trade Association (EFTA).</p>
	<p>Certified by CSA Group to North American safety standards.</p>
	<p>Conforms to relevant Australian standards.</p>
	<p>Conforms to relevant Russian standards.</p>
	<p>EMC approval for Korea. Class A Equipment (Industrial Broadcasting and Communication Equipment). This product meets requirements for industrial (Class A) electromagnetic wave equipment and the seller or user should take notice of it. This equipment is intended for use in business environments and is not to be used in homes.</p>
	<p>This key turns the Product on and off.</p>

Safety Information

Warning

To prevent possible fire, electric shock, or personal injury:

- Read all safety information before you use the Product.
- Carefully read all instructions.
- Do not open the case. You cannot repair or replace parts in the case.
- Do not modify the Product.
- Use only replacement parts that are approved by Fluke Networks.
- Do not touch voltages > 30 V AC rms, 42 V AC peak, or 60 V DC.
- Do not use the Product around explosive gas, vapor, or in damp or wet environments.
- Use this Product indoors only.
- Use the Product only as specified, or the protection supplied by the Product can be compromised.
- Do not use and disable the Product if it is damaged.
- Do not use the Product if it operates incorrectly.
- Batteries contain hazardous chemicals that can cause burns or explode. If exposure to chemicals occurs, clean with water and get medical aid.
- Remove the batteries if the Product is not used for an extended period of time, or if stored in temperatures above 50 °C. If the batteries are not removed, battery leakage can damage the Product.
- Replace the rechargeable battery after 5 years of moderate use or 2 years of heavy use. Moderate use is defined as recharged twice a week. Heavy use is defined as discharged to cutoff and recharged daily.
- Disconnect the battery charger and move the Product or battery to a cool, non-flammable location if the rechargeable battery becomes hot (>50 °C, >122 °F) during the charge period.
- The battery door must be closed and locked before you operate the Product.
- Repair the Product before use if the battery leaks.
- Recharge the batteries when the low battery indicator shows to prevent incorrect measurements.

- Do not disassemble or crush battery cells and battery packs.
- Do not put battery cells and battery packs near heat or fire. Do not put in sunlight.
- Have an approved technician repair the Product.
- For Products with rechargeable batteries, use only AC adapters approved by Fluke Networks for use with the Product to supply power to the Product and charge the battery.

Warning: Class 1 and Class 2 Laser Products

To prevent eye damage and personal injury:

- Do not look directly into optical connectors. Some optical equipment emits invisible radiation that can cause permanent damage to your eyes.
- Do not look into the laser. Do not point laser directly at persons or animals or indirectly off reflective surfaces.
- When you inspect fiber endfaces, use only magnification devices that have the correct filters.
- Use the Product only as specified or hazardous laser radiation exposure can occur.

Caution

To prevent damage to the Product or cables under test and to prevent data loss, read all safety information given in all documentation supplied with the Product.

Connectors, Keys, and LEDs

See Figure 1:

- ① LCD display with touchscreen.
- ② Singlemode OTDR port with interchangeable SC adapter and protective cap. The LED in front of the port turns on when the port emits an optical signal.
- ③ Multimode OTDR port with interchangeable SC adapter and protective cap. The LED in front of the port turns on when the port emits an optical signal.
- ④ Visual fault locator port and protective cap. The LED in front of the port turns on when the port emits an optical signal.

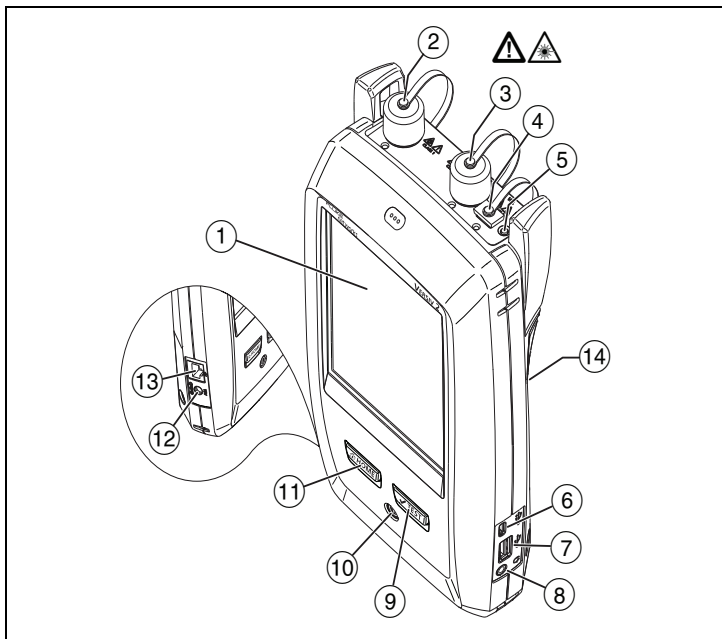

Warning

Do not look directly into optical connectors. Some sources emit invisible radiation that can cause permanent damage to your eyes.



GPU06.EPS

Figure 1. Connectors, Keys, and LEDs (Versiv 2 shown)

- ⑤ Button that controls the VFL.
- ⑥ Micro USB port: This USB port lets you connect the tester to a PC so you can upload test results to the PC and install software updates in the tester.
- ⑦ Type A USB port: This USB host port lets you save test results on a USB flash drive and connect the FI-1000 video probe to the tester. Versiv: Also lets you connect a Wi-Fi adapter for access to Fluke Networks cloud services. (Versiv 2 testers have an internal Wi-Fi radio.)
- ⑧ Headset jack.
- ⑨ : Starts a test. To start a test, you can also tap **TEST** on the display.
- ⑩ Power button. Versiv 2: The LED in the power button shows the status of the battery charging process. See the Users Manual.
- ⑪ : Press  to go to the home screen.
- ⑫ Connector for the AC adapter. Versiv: The LED is red when the battery charges, and green when the battery is fully charged. The LED is yellow if the battery will not charge.
- ⑬ RJ45 connector: Lets you connect to a network for access to Fluke Networks cloud services.

- ⑭ Decal with laser safety information:



How to Do an OTDR Test

1 Power the Tester

Charge the battery if necessary. Connect the AC adapter to AC power and to the adapter connector (⑫) shown in Figure 1. You can use the tester while the battery charges.

2 Select Settings

2-1 On the home screen, tap the test setup panel (see Figure 2, number ②).

-continued-

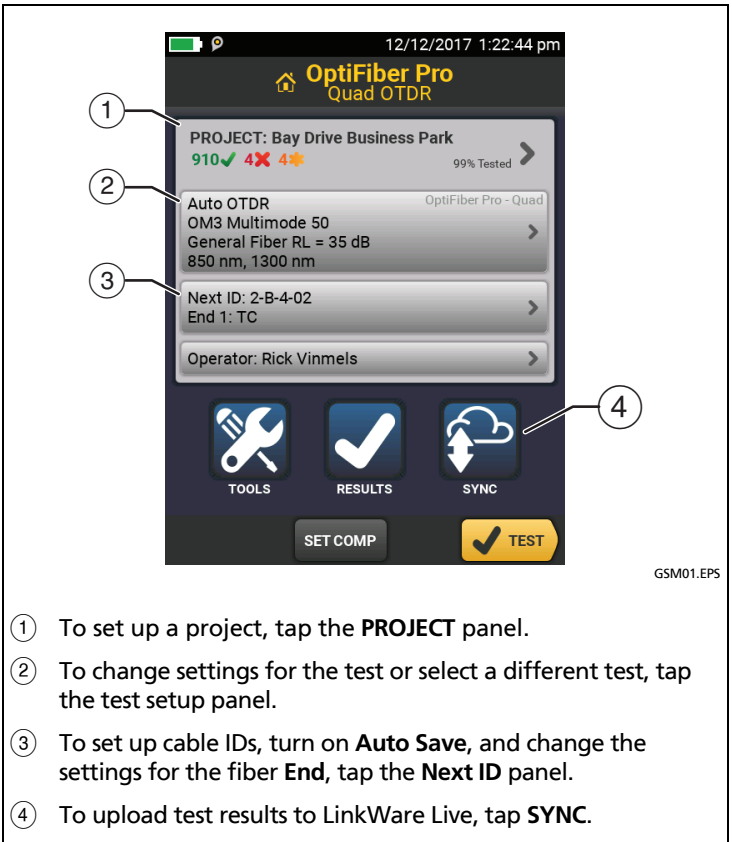

GSM01.EPS

- ① To set up a project, tap the **PROJECT** panel.
- ② To change settings for the test or select a different test, tap the test setup panel.
- ③ To set up cable IDs, turn on **Auto Save**, and change the settings for the fiber **End**, tap the **Next ID** panel.
- ④ To upload test results to LinkWare Live, tap **SYNC**.

Figure 2. Panels on the Home Screen

- 2-2 On the **CHANGE TEST** screen, tap **EDIT**.
- 2-3 On the **TEST SETUP** screen, tap the panels to change settings:
 - **Test Type:** Select **Auto OTDR**.
 - **Launch Compensation:** If you will use launch/tail cords set this to **On**.
 - **Wavelength:** Select the wavelengths for the test.
 - **Fiber Type:** On the **FIBER TYPE** screen, select a fiber type that is applicable. To see a different group of fiber types, tap **MORE**, then tap a group.
 - **Test Limit:** Select the correct test limit for the job. To see a different group of limits, tap **MORE**, then tap the name of a group.
- 2-4 To save the settings, tap **SAVE** on the **TEST SETUP** screen.

3 **Compensate for Launch and Tail Cords (recommended)**

Launch and tail cords let the tester measure the loss and reflectance of the first and last connectors in the cabling and also include them in the measurement of overall loss. Without launch and tail cords, no backscatter is available before the first connector nor after the last.

Fluke Networks recommends that you use launch and tail cords. You should also use the launch/tail cord compensation function to remove the lengths of these fibers from the OTDR measurements.

To compensate for launch and tail cords

- 3-1 Select launch and tail cords that have the same type of fiber as the fiber you will test.
- 3-2 On the home screen, tap **SET COMP**.
- 3-3 On the **SET LAUNCH METHOD** screen tap **Launch + Tail**.
- 3-4 Clean and inspect the OTDR port and the launch/tail cord connectors.
- 3-5 Make the connections shown in Figure 3.
- 3-6 Tap **SET**.
- 3-7 When the **SET LAUNCH COMP** screen shows, select the event that is the end of the launch cord and the start of the tail cord, if this event is not already selected.
- 3-8 Tap **SAVE**.

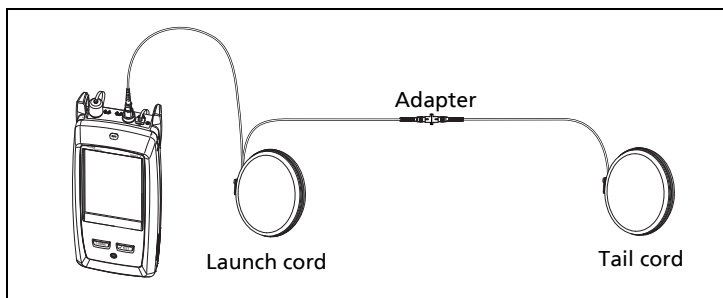

GSM03.EPS

Figure 3. Connections for Launch + Tail Compensation

4 Do the OTDR Test

- 4-1 Clean and inspect the connectors on the launch and tail cords and the fiber to be tested.
- 4-2 Connect the tester to the link as shown in Figure 4.
- 4-3 Tap **TEST** or press .

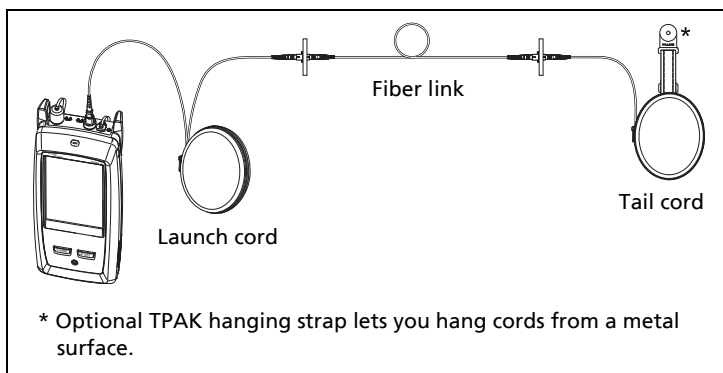

* Optional TPAK hanging strap lets you hang cords from a metal surface.

GSM02.EPS

Figure 4. Connections for an OTDR Test

5 Examine the Results

The tester shows the OTDR results in three formats (Figure 5):

- **EventMap:** Shows a diagram of the events on the fiber, the fiber length, and the overall loss of the fiber. Use this screen to quickly locate connectors and faults on the fiber. To see details for an event, tap the event in the map, then tap the information window for the event.
- **TABLE:** Shows a table of the events on the fiber. Use this screen to quickly see measurements for all events and see the types of events that are on the fiber. The table includes the distance to the event, the loss of the event, the size of the reflection from the event, and the type of the event. To see details for an event, tap the event in the table.
- **TRACE:** Shows the OTDR trace. Use this screen to see the deadzones of reflective events and examine the characteristics of unexpected events such as ghosts and gainers.

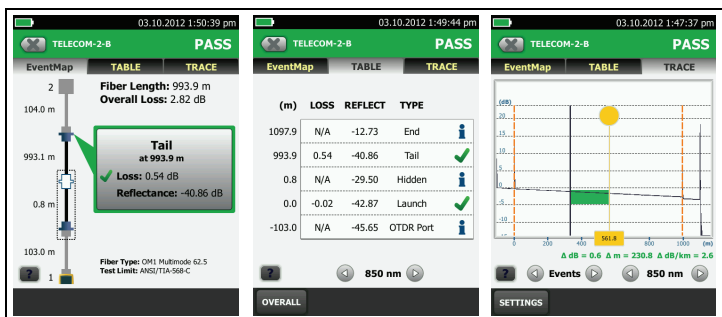

GPU26.EPS

Figure 5. Examples of OTDR Results Screens

6 Save the Results

6-1 Tap **SAVE** if the test passed or **FIX LATER** if the test failed.

6-2 If the **Cable ID** box shows the correct ID, tap **SAVE**.

To enter a cable ID, tap the **Cable ID** box on the **SAVE RESULT** screen, use the keyboard to enter a name for the results, tap **DONE**, then tap **SAVE**.

The tester saves the results in the **DEFAULT** project, unless you selected a different project.

About Projects

You can set up a project to specify the settings and tests necessary for a job, monitor the status of a job, and organize the test results.

To start a new project, tap **PROJECT** on the home screen, tap **CHANGE PROJECT**, then tap **NEW PROJECT**. See the Users Manual or Technical Reference Handbook for more information.

About Fluke Networks Cloud Services

With a Fluke Networks web account and a wired or wireless network connection, you can use the LinkWare Live web application to store and manage projects in the cloud.

Go to <https://www.linkwarelive.com/signin> or see the Users Manual or Technical Reference Handbook for more information.

Registration

Registering your product with Fluke Networks gives you access to valuable information on product updates, troubleshooting tips, and other support services.

To register, use LinkWare PC software. Download LinkWare PC from the Fluke Networks website.

Contact Fluke Networks



www.flukenetworks.com/support



info@flukenetworks.com



1-800-283-5853, +1-425-446-5500



Fluke Networks
6920 Seaway Boulevard, MS 143F
Everett WA 98203 USA

Fluke Networks operates in more than 50 countries worldwide. For more contact information, go to our website.

General Specifications

Battery Type	Lithium-ion
Power Adapter	Input: 100 to 240 VAC \pm 10%, 50/60Hz Output: 15 VDC, 2 A maximum Class II
Versiv 2 wireless radio*	Frequency ranges: 2.4 GHz band: 2412 MHz to 2484 MHz 5 GHz band: 4910 MHz to 5825 MHz Output power: <100 mW
Temperature	Operating: -10 °C to +45 °C Storage: -10 °C to +60 °C
Altitude	Operating: 4,000 m (3,200 m with AC adapter) Storage: 12,000 m
* For more information, go to www.flukenetworks.com/manuals and search for "Radio Frequency Data for Class A".	

LIMITED WARRANTY AND LIMITATION OF LIABILITY

Fluke Networks mainframe products will be free from defects in material and workmanship for one year from the date of purchase, unless stated otherwise herein. Parts, accessories, product repairs and services are warranted for 90 days, unless otherwise stated. Ni-Cad, Ni-MH and Li-Ion batteries, cables or other peripherals are all considered parts or accessories. This warranty does not cover damage from accident, neglect, misuse, alteration, contamination, or abnormal conditions of operation or handling. Resellers are not authorized to extend any other warranty on Fluke Networks' behalf. To obtain service during the warranty period, contact your nearest Fluke Networks authorized service center to obtain return authorization information, then send your defective product to that Service Center with a description of the problem.

For a list of authorized resellers, visit www.flukenetworks.com/wheretobuy.

THIS WARRANTY IS YOUR ONLY REMEDY. NO OTHER WARRANTIES, SUCH AS FITNESS FOR A PARTICULAR PURPOSE, ARE EXPRESSED OR IMPLIED. FLUKE NETWORKS IS NOT LIABLE FOR ANY SPECIAL, INDIRECT, INCIDENTAL OR CONSEQUENTIAL DAMAGES OR LOSSES, ARISING FROM ANY CAUSE OR THEORY. Since some states or countries do not allow the exclusion or limitation of an implied warranty or of incidental or consequential damages, this limitation of liability may not apply to you.

4/15

Fluke Networks
PO Box 777
Everett, WA 98206-0777
USA