



Advanced Test Equipment Rentals
www.atecorp.com 800-404-ATEC (2832)

User Manual

Tektronix

TDS 684A, TDS 744A & TDS 784A
Digitizing Oscilloscopes

070-8991-02

Copyright © Tektronix, Inc. 1994. All rights reserved. Licensed software products are owned by Tektronix or its suppliers and are protected by United States copyright laws and international treaty provisions.

Use, duplication, or disclosure by the Government is subject to restrictions as set forth in subparagraph (c)(1)(ii) of the Rights in Technical Data and Computer Software clause at DFARS 252.227-7013, or subparagraphs (c)(1) and (2) of the Commercial Computer Software – Restricted Rights clause at FAR 52.227-19, as applicable.

Tektronix products are covered by U.S. and foreign patents, issued and pending. Information in this publication supercedes that in all previously published material. Specifications and price change privileges reserved.

Printed in the U.S.A.

Tektronix, Inc., P.O. Box 1000, Wilsonville, OR 97070-1000

TEKTRONIX, TEK, FastFrame[™], FlexFormat[™], and InstaVu[™] are registered trademarks of Tektronix, Inc.

WARRANTY

Tektronix warrants that this product will be free from defects in materials and workmanship for a period of three (3) years from the date of shipment. If any such product proves defective during this warranty period, Tektronix, at its option, either will repair the defective product without charge for parts and labor, or will provide a replacement in exchange for the defective product.

In order to obtain service under this warranty, Customer must notify Tektronix of the defect before the expiration of the warranty period and make suitable arrangements for the performance of service. Customer shall be responsible for packaging and shipping the defective product to the service center designated by Tektronix, with shipping charges prepaid. Tektronix shall pay for the return of the product to Customer if the shipment is to a location within the country in which the Tektronix service center is located. Customer shall be responsible for paying all shipping charges, duties, taxes, and any other charges for products returned to any other locations.

This warranty shall not apply to any defect, failure or damage caused by improper use or improper or inadequate maintenance and care. Tektronix shall not be obligated to furnish service under this warranty a) to repair damage resulting from attempts by personnel other than Tektronix representatives to install, repair or service the product; b) to repair damage resulting from improper use or connection to incompatible equipment; or c) to service a product that has been modified or integrated with other products when the effect of such modification or integration increases the time or difficulty of servicing the product.

THIS WARRANTY IS GIVEN BY TEKTRONIX WITH RESPECT TO THIS PRODUCT IN LIEU OF ANY OTHER WARRANTIES, EXPRESSED OR IMPLIED. TEKTRONIX AND ITS VENDORS DISCLAIM ANY IMPLIED WARRANTIES OF MERCHANTABILITY OR FITNESS FOR A PARTICULAR PURPOSE. TEKTRONIX' RESPONSIBILITY TO REPAIR OR REPLACE DEFECTIVE PRODUCTS IS THE SOLE AND EXCLUSIVE REMEDY PROVIDED TO THE CUSTOMER FOR BREACH OF THIS WARRANTY. TEKTRONIX AND ITS VENDORS WILL NOT BE LIABLE FOR ANY INDIRECT, SPECIAL, INCIDENTAL, OR CONSEQUENTIAL DAMAGES IRRESPECTIVE OF WHETHER TEKTRONIX OR THE VENDOR HAS ADVANCE NOTICE OF THE POSSIBILITY OF SUCH DAMAGES.

German Postal Information

Certificate of the Manufacturer/Importer

We hereby certify that the TDS 684A, TDS 744A, and TDS 784A Digitizing Oscilloscopes and all factory-installed options comply with the RF Interference Suppression requirements of Postal Regulation Vfg. 243/1991, amended per Vfg. 46/1992.

The German Postal Service was notified that the equipment is being marketed.

The German Postal Service has the right to re-test the series and to verify that it complies.

TEKTRONIX

Bescheinigung des Herstellers/Importeurs

Hiermit wird bescheinigt, daß das TDS 684A, TDS 744A, and TDS 784A Digitizing Oscilloscopes und alle fabrikinstallierten Optionen in Übereinstimmung mit den Bestimmungen der Amtsblatt-Verfügung Vfg. 243/1991 und Zusatzverfügung 46/1992 funkentstört sind.

Der Deutschen Bundespost wurde das Inverkehrbringen dieses Gerätes angezeigt und die Berechtigung zur Überprüfung der Serie auf Einhalten der Bestimmungen eingeräumt.

TEKTRONIX

NOTICE to the user/operator:

The German Postal Service requires that systems assembled by the operator/user of this instrument must also comply with Postal Regulation, Vfg. 243/1991, Par. 2, Sect. 1.

HINWEIS für den Benutzer/Betreiber:

Die vom Betreiber zusammengestellte Anlage, innerhalb derer dieses Gerät eingesetzt wird, muß ebenfalls den Voraussetzungen nach Par. 2, Ziff. 1 der Vfg. 243/1991, genügen.

NOTICE to the user/operator:

The German Postal Service requires that this equipment, when used in a test setup, may only be operated if the requirements of Postal Regulation, Vfg. 243/1991, Par. 2, Sect. 1.8.1 are complied with.

HINWEIS für den Benutzer/Betreiber:

Dieses Gerät darf in Meßaufbauten nur betrieben werden, wenn die Voraussetzungen des Par. 2, Ziff. 1.8.1 der Vfg. 243/1991 eingehalten werden.



EC Declaration of Conformity

We

Tektronix Holland N.V.
Marktweg 73A
8444 AB Heerenveen
The Netherlands

declare under sole responsibility that the

TDS 684A, TDS 744A, and TDS 784A Digitizing Oscilloscopes

meet the intent of Directive 89/336/EEC for Electromagnetic Compatibility. Compliance was demonstrated to the following specifications as listed in the official Journal of the European Communities:

EN 50081-1 Emissions:

EN 55022	Radiated, Class B
EN 55022	Radiated, Class B
EN 60555-2	Power Harmonics

EN 50082-1 Immunity:

IEC 801-2	Electrostatic Discharge
IEC 801-3	RF Radiated
IEC 801-4	Fast Transients
IEC 801-5	Surge

Table of Contents

	General Safety Summary	ix
	Preface	xiii
	Related Manuals	xiii
	Conventions	xiv
	Default Model	xiv
Getting Started		
	Product Description	1-1
	Product Specification	1-2
	Start Up	1-3
	Preparation	1-3
	Putting into Service	1-4
Operating Basics		
	Overview	2-1
	Operating Interface Maps	2-3
	Tutorial	2-9
	Setting Up for the Examples	2-9
	Example 1: Displaying a Waveform	2-13
	Example 2: Displaying Multiple Waveforms	2-15
	Example 3: Taking Automated Measurements	2-19
	Example 4: Saving Setups	2-24
Reference		
	Overview	3-1
	Acquiring and Displaying Waveforms	3-3
	Coupling Waveforms to the Oscilloscope	3-3
	Setting up Automatically: Autoset and Reset	3-5
	Selecting Channels	3-7
	Scaling and Positioning Waveforms	3-9
	Choosing an Acquisition Mode	3-16
	Customizing the Display	3-27
	Customizing the Display Color	3-33
	Zooming on Waveforms	3-37
	Using InstaVu Acquisition Mode (TDS 700A Models Only)	3-43
	Using FastFrame (TDS 700A Models Only)	3-46
	Triggering on Waveforms	3-49
	Triggering Concepts	3-49
	Triggering from the Front Panel	3-53
	Triggering on a Waveform Edge	3-57
	Triggering Based on Logic	3-60
	Triggering on Pulses	3-70

Delayed Triggering	3-80
Measuring Waveforms	3-87
Taking Automated Measurements	3-87
Taking Cursor Measurements	3-97
Taking Graticule Measurements	3-101
Optimizing Measurement Accuracy: SPC and Probe Cal	3-102
Saving Waveforms and Setups	3-111
Saving and Recalling Setups	3-111
Saving and Recalling Waveforms	3-114
Managing the File System	3-117
Printing a Hardcopy	3-120
Communicating with Remote Instruments	3-128
Determining Status and Accessing Help	3-133
Displaying Status	3-133
Displaying Help	3-135
Using Features for Advanced Applications	3-137
Limit Testing	3-137
Waveform Math	3-142
Fast Fourier Transforms	3-144
Waveform Differentiation	3-161
Waveform Integration	3-165

Appendices

Appendix A: Options and Accessories	A-1
Appendix B: Algorithms	B-1
Appendix C: Packaging for Shipment	C-1
Appendix D: Factory Initialization Settings	D-1
Appendix E: Probe Selection	E-1

Glossary

Index

List of Figures

Figure 1–1: Rear Panel Controls Used in Start Up	1–4
Figure 1–2: ON/STBY Button	1–5
Figure 2–1: Connecting a Probe for the Examples (P6245 shown) ..	2–9
Figure 2–2: SETUP Button Location	2–10
Figure 2–3: The Setup Menu	2–10
Figure 2–4: Trigger Controls	2–11
Figure 2–5: The Display After Factory Initialization	2–12
Figure 2–6: The VERTICAL and HORIZONTAL Controls	2–13
Figure 2–7: TRIGGER Controls	2–14
Figure 2–8: AUTOSET Button Location	2–14
Figure 2–9: The Display After Pressing Autoset	2–15
Figure 2–10: Display Signals Requiring Probe Compensation	2–15
Figure 2–11: The Channel Buttons and Lights	2–16
Figure 2–12: The Vertical Main Menu and Coupling Side Menu	2–17
Figure 2–13: The Menus After Changing Channels	2–18
Figure 2–14: Measure Main Menu and Select Measurement Side Menu	2–20
Figure 2–15: Four Simultaneous Measurement Readouts	2–21
Figure 2–16: General Purpose Knob Indicators	2–22
Figure 2–17: Snapshot of Channel 1	2–23
Figure 2–18: Save/Recall Setup Menu	2–25
Figure 3–1: How Probe Compensation Affects Signals	3–4
Figure 3–2: P6139A Probe Adjustment	3–4
Figure 3–3: The Channel Readout	3–8
Figure 3–4: Waveform Selection Priority	3–9
Figure 3–5: Scaling and Positioning	3–10
Figure 3–6: Vertical Readouts and Channel Menu	3–11
Figure 3–7: Record View and Time Base Readouts	3–13
Figure 3–8: Horizontal Controls	3–14
Figure 3–9: Acquisition: Input Analog Signal, Sample, and Digitize	3–17
Figure 3–10: Several Points May be Acquired for Each Point Used	3–17

Figure 3–11: Real-Time Sampling	3–17
Figure 3–12: Equivalent-Time Sampling	3–18
Figure 3–13: How the Acquisition Modes Work	3–21
Figure 3–14: Acquisition Menu and Readout	3–23
Figure 3–15: Acquire Menu — Stop After	3–25
Figure 3–16: Aliasing	3–27
Figure 3–17: Display Menu — Style	3–29
Figure 3–18: Trigger Point and Level Indicators	3–30
Figure 3–19: Display Menu — Setting	3–33
Figure 3–20: Display Menu — Palette Colors	3–35
Figure 3–21: Display Menu — Map Reference Colors	3–36
Figure 3–22: Display Menu — Restore Colors	3–37
Figure 3–23: Zoom Mode with Horizontal Lock Set to None	3–39
Figure 3–24: Dual Window (Preview) Mode	3–41
Figure 3–25: Dual Zoom — Shown in Dual Window (Preview) Mode	3–42
Figure 3–26: Normal DSO Acquisition and Display Mode Versus InstaVu Mode	3–44
Figure 3–27: InstaVu Display	3–45
Figure 3–28: Fast Frame	3–46
Figure 3–29: Horizontal Menu — FastFrame Setup	3–47
Figure 3–30: Triggered Versus Untriggered Displays	3–49
Figure 3–31: Trigger Holdoff Time Ensures Valid Triggering	3–52
Figure 3–32: Slope and Level Controls Help Define the Trigger	3–53
Figure 3–33: TRIGGER Controls and Status Lights	3–54
Figure 3–34: Example Trigger Readouts — Edge Trigger Selected	3–56
Figure 3–35: Record View, Trigger Position, and Trigger Level Bar Readouts	3–56
Figure 3–36: Edge Trigger Readouts	3–57
Figure 3–37: Main Trigger Menu — Edge Type	3–58
Figure 3–38: Violation Zones for Setup/Hold Triggering	3–63
Figure 3–39: Logic Trigger Readouts — State Class Selected	3–64
Figure 3–40: Logic Trigger Menu	3–65
Figure 3–41: Logic Trigger Menu — Time Qualified TRUE	3–67
Figure 3–42: Triggering on a Setup/Hold Time Violation	3–70
Figure 3–43: Pulse Trigger Readouts	3–71
Figure 3–44: Main Trigger Menu — Glitch Class	3–73
Figure 3–45: Main Trigger Menu — Runt Class	3–75

Figure 3-46: Main Trigger Menu — Slew Rate Class	3-79
Figure 3-47: Delayed Runs After Main	3-81
Figure 3-48: Delayed Triggerable	3-81
Figure 3-49: How the Delayed Triggers Work	3-82
Figure 3-50: Delayed Trigger Menu	3-84
Figure 3-51: Graticule, Cursor and Automated Measurements	3-87
Figure 3-52: Measurement Readouts	3-90
Figure 3-53: Measure Menu	3-91
Figure 3-54: Measure Menu — Gating	3-92
Figure 3-55: Measure Menu — Reference Levels	3-93
Figure 3-56: Measure Delay Menu — Delay To	3-94
Figure 3-57: Snapshot Menu and Readout	3-96
Figure 3-58: Cursor Types	3-97
Figure 3-59: Cursor Modes	3-98
Figure 3-60: H Bars Cursor Menu and Readouts	3-99
Figure 3-61: Paired Cursor Menu and Readouts	3-100
Figure 3-62: Performing a Signal Path Compensation	3-104
Figure 3-63: Probe Cal Menu and Gain Compensation Display	3-106
Figure 3-64: Re-use Probe Calibration Data Menu	3-108
Figure 3-65: Save/Recall Setup Menu	3-112
Figure 3-66: Save Waveform Menu	3-115
Figure 3-67: More Menu	3-116
Figure 3-68: File Utilities	3-118
Figure 3-69: File System — Labeling Menu	3-119
Figure 3-70: Utility Menu — System I/O	3-122
Figure 3-71: Hardcopy Formats	3-123
Figure 3-72: Date and Time Display	3-124
Figure 3-73: Connecting the Oscilloscope Directly to the Hardcopy Device	3-125
Figure 3-74: Connecting the Oscilloscope and Hardcopy Device Via a PC	3-127
Figure 3-75: Typical GPIB Network Configuration	3-129
Figure 3-76: Stacking GPIB Connectors	3-130
Figure 3-77: Connecting the Oscilloscope to a Controller	3-131
Figure 3-78: Utility Menu	3-132
Figure 3-79: Status Menu — System	3-134
Figure 3-80: Banner Display	3-134
Figure 3-81: Initial Help Screen	3-135
Figure 3-82: Comparing a Waveform to a Limit Template	3-137

Figure 3–83: Acquire Menu — Create Limit Test Template	3–139
Figure 3–84: More Menu	3–142
Figure 3–85: Dual Waveform Math Main and Side Menus	3–143
Figure 3–86: System Response to an Impulse	3–146
Figure 3–87: Define FFT Waveform Menu	3–147
Figure 3–88: FFT Math Waveform in Math1	3–148
Figure 3–89: Cursor Measurement of an FFT Waveform	3–150
Figure 3–90: Waveform Record vs. FFT Time Domain Record	3–151
Figure 3–91: FFT Time Domain Record vs. FFT Frequency Domain Record	3–152
Figure 3–92: How Aliased Frequencies Appear in an FFT	3–156
Figure 3–93: Windowing the FFT Time Domain Record	3–159
Figure 3–94: FFT Windows and Bandpass Characteristics	3–161
Figure 3–95: Derivative Math Waveform	3–163
Figure 3–96: Peak-Peak Amplitude Measurement of a Derivative Waveform	3–164
Figure 3–97: Integral Math Waveform	3–167
Figure 3–98: H Bars Cursors Measure an Integral Math Waveform	3–168
Figure B–1: MCross Calculations	B–4
Figure B–2: Fall Time	B–7
Figure B–3: Rise Time	B–11
Figure B–4: Choosing Minima or Maxima to Use for Envelope Measurements	B–13
Figure E–1: Typical High Voltage Probes	E–2
Figure E–2: A6303 Current Probe Used in the AM 503S Opt. 03 ...	E–4

List of Tables

Table 1–1: Key Features of the TDS Oscilloscopes	1–1
Table 1–2: Fuse and Fuse Cap Part Numbers	1–5
Table 3–1: Autoset Defaults	3–6
Table 3–2: How Interleaving Affects Sample Rate	3–19
Table 3–3: Additional Resolution Bits	3–22
Table 3–4: TDS 744A Sampling Mode Selection (When Fit to Screen is Off)	3–24
Table 3–5: TDS 784A Sampling Mode Selection (When Fit to Screen is Off)	3–25
Table 3–6: XY Format Pairs	3–32
Table 3–7: Pattern and State Logic	3–62
Table 3–8: Pulse Trigger Definitions	3–71
Table 3–9: Measurement Definitions	3–88
Table 3–10: Probe Cal Status	3–109
Table A–1: Options	A–1
Table A–2: Standard Accessories	A–3
Table A–3: Optional Accessories	A–4
Table A–4: Accessory Software	A–5
Table D–1: Factory Initialization Defaults	D–1

General Safety Summary

Review the following safety precautions to avoid injury and prevent damage to this product or any products connected to it.

Only qualified personnel should perform service procedures.

Injury Precautions

- | | |
|---|--|
| Use Proper Power Cord | To avoid fire hazard, use only the power cord specified for this product. |
| Avoid Electric Overload | To avoid electric shock or fire hazard, do not apply a voltage to a terminal that is outside the range specified for that terminal. |
| Ground the Product | This product is grounded through the grounding conductor of the power cord. To avoid electric shock, the grounding conductor must be connected to earth ground. Before making connections to the input or output terminals of the product, ensure that the product is properly grounded. |
| Do Not Operate Without Covers | To avoid electric shock or fire hazard, do not operate this product with covers or panels removed. |
| Use Proper Fuse | To avoid fire hazard, use only the fuse type and rating specified for this product. |
| Do Not Operate in Wet/Damp Conditions | To avoid electric shock, do not operate this product in wet or damp conditions. |
| Do Not Operate in Explosive Atmosphere | To avoid injury or fire hazard, do not operate this product in an explosive atmosphere. |
| Keep Probe Surface Clean | To avoid electric shock and erroneous readings, keep probe surface clean. |

Product Damage Precautions

- | | |
|--------------------------------|---|
| Use Proper Power Source | Do not operate this product from a power source that applies more than the voltage specified. |
|--------------------------------|---|

- Provide Proper Ventilation** To prevent product overheating, provide proper ventilation.
- Do Not Operate With Suspected Failures** If you suspect there is damage to this product, have it inspected by qualified service personnel.
- Do Not Immerse in Liquids** Clean the probe using only a damp cloth. Refer to cleaning instructions.

Safety Terms and Symbols

Terms in This Manual These terms may appear in this manual:



WARNING. *Warning statements identify conditions or practices that could result in injury or loss of life.*



CAUTION. *Caution statements identify conditions or practices that could result in damage to this product or other property.*

Terms on the Product These terms may appear on the product:

DANGER indicates an injury hazard immediately accessible as you read the marking.

WARNING indicates an injury hazard not immediately accessible as you read the marking.

CAUTION indicates a hazard to property including the product.

Symbols on the Product The following symbols may appear on the product:



DANGER
High Voltage



Protective Ground
(Earth) Terminal



ATTENTION
Refer to
Manual



Double
Insulated

Certifications and Compliances

CSA Certified Power Cords

CSA Certification includes the products and power cords appropriate for use in the North America power network. All other power cords supplied are approved for the country of use.

Preface

This is the User Manual for the TDS 684A, TDS 744A, and TDS 784A Digitizing Oscilloscopes.

The chapter *Getting Started* briefly describes the TDS Oscilloscope, prepares you to install it, and tells you how to put it into service.

The chapter *Operating Basics* covers basic principles of the operation of the oscilloscope. The operating interface illustrations and the tutorial examples rapidly help you understand how your oscilloscope operates.

The chapter *Reference* teaches you how to perform specific tasks. See page 3–1 for a complete list of operating tasks covered in that chapter.

The *Appendices* provide an options listing, an accessories listing, and other useful information.

Related Manuals

The following documents are related to the use or service of the oscilloscope.

- The *TDS Family Digitizing Oscilloscopes Programmer Manual* (Tektronix part number 070-8709-xx) describes using a computer to control the oscilloscope through the GPIB interface.
- The *TDS 684A, TDS 744A, & TDS 784A Reference* (Tektronix part number 070-8999-xx) gives you a quick overview of how to operate the oscilloscope.
- The *TDS 684A, TDS 744A, & TDS 784A Performance Verification and Specifications* (Tektronix part number 070-8990-xx) tells how to verify the performance of the oscilloscope and lists its specifications.
- The *TDS Family Option 05 Video Trigger Instruction Manual* (Tektronix part number 070-8748-xx) describes use of the video trigger option (for TDS oscilloscopes equipped with that option only).
- The *TDS 684A, TDS 744A, & TDS 784A Service Manual* (Tektronix part number 070-8992-xx) provides information for maintaining and servicing the oscilloscope to the module level.

Conventions

In this manual, you will find various procedures which contain steps of instructions for you to perform. To keep those instructions clear and consistent, this manual uses the following conventions:

- In procedures, names of front panel controls and menu labels appear in boldface print.
- Names also appear in the same case (initial capitals or all uppercase) in the manual as is used on the oscilloscope front panel and menus. Front panel names are all upper case letters, for example, **VERTICAL MENU** and **CH 1**.
- Instruction steps are numbered. The number is omitted if there is only one step.
- When steps require that you make a sequence of selections using front panel controls and menu buttons, an arrow (→) marks each transition between a front panel button and a menu, or between menus. Also, whether a name is a main menu or side menu item is clearly indicated: Press **VERTICAL MENU** → **Coupling** (main) → **DC** (side) → **Bandwidth** (main) → **250 MHz** (side).

Using the convention just described results in instructions that are graphically intuitive and simplifies procedures. For example, the instruction just given replaces these five steps:

1. Press the front panel button **VERTICAL MENU**.
2. Press the main-menu button **Coupling**.
3. Press the side-menu button **DC**.
4. Press the main-menu button **Bandwidth**.
5. Press the side-menu button **250 MHz**.

Sometimes you may have to make a selection from a pop-up menu: Press **TRIGGER MENU** → **Type** (main) → **Edge** (pop-up). In this example, you repeatedly press the main menu button **Type** until **Edge** is highlighted in the pop-up menu.

Default Model

This manual documents the TDS 684A, TDS 744A, and TDS 784A Digitizing Oscilloscopes. However, the TDS 684A display screen appears as the default screen wherever a display screen is illustrated in this manual. Also, this manual uses the name “TDS 700A” when providing information common to both the TDS 744A and TDS 784A model oscilloscopes.

Product Description

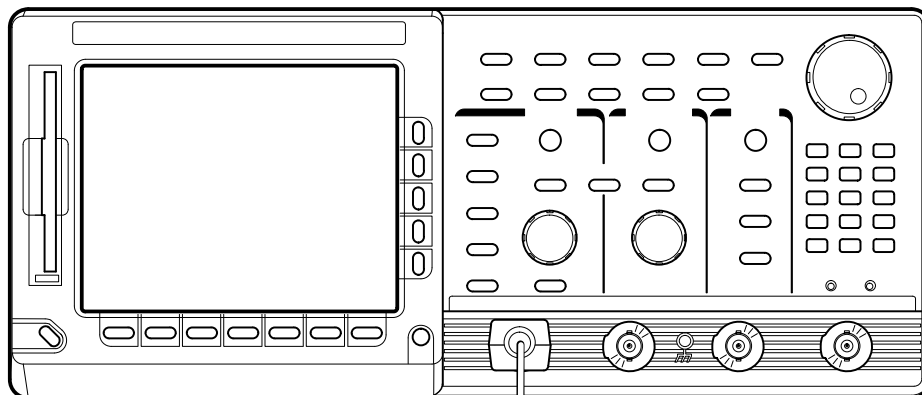

The Tektronix TDS Oscilloscope is a superb tool for acquiring, displaying, and measuring waveforms. Its performance addresses the needs of both benchtop lab and portable applications with the following features:

Table 1-1: Key Features of the TDS Oscilloscopes

Feature	TDS 684A	TDS 744A	TDS 784A
Digitizing rate, maximum	5 GS/s on each channel simultaneously	2 GS/s	4 GS/s
Analog bandwidth	1 GHz	500 MHz	1 GHz
Channels	Four, each with 8-bit resolution		
Record lengths, maximum	15 K samples per channel	Up to 50 K standard, up to 250 K (2 channels) and 500 K (1 channel) with Option 1M	
Acquisition modes	Sample, envelope, and average	Sample, envelope, average, high-resolution, and peak-detect <i>InstaVu™</i> mode, which updates the display at rates rivaling the fastest analog oscilloscopes	
Display	<i>Color</i> <i>Zoom</i> , which allows you to magnify a waveform	<i>Color</i> <i>Dual Window Zoom</i> , which shows a waveform magnified and unmagnified on the same display	

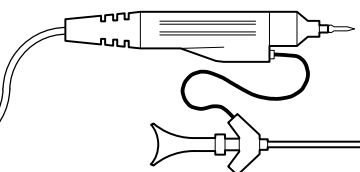

Table 1-1: Key Features of the TDS Oscilloscopes (Cont.)

Feature	TDS 684A	TDS 744A	TDS 784A
Trigger modes	Include: edge, logic, and pulse. Video trigger, with option 05, modes include: NTSC, SECAM, PAL, HDTV, and FlexFormat™.		
Storage	1.44 Mbyte, 3.5 inch, DOS 3.3-or-later floppy disk. NVRAM storage for saving waveforms, hardcopies, and setups		
I/O	Full GPIB programmability. Hardcopy output using GPIB, RS-232, or Centronics ports		

Product Specification

The product specification is found in the technical reference *TDS 684A, TDS 744A, & TDS 784A Performance Verification and Specifications* that is shipped as a standard accessory with the TDS Oscilloscope.

Start Up

Before you use the TDS Oscilloscope, ensure that it is properly installed and powered on.

Preparation

To ensure maximum accuracy for your most critical measurements, you should know about signal path compensation and the proper use of the probe you choose to use with your oscilloscope.

Signal Path Compensation

Be sure you compensate your oscilloscope for the surrounding temperature. This action, called *Signal Path Compensation (SPC)*, ensures maximum possible accuracy for your most critical measurements. See *Signal Path Compensation* on page 3–102 for a description of and operating information on this feature.

Recommended Probes

The TDS 744A Oscilloscope ships with four general-purpose, P6139A 500 MHz passive probes. The TDS 684A and TDS 784A Oscilloscopes ship without probes. To take advantage of the higher bandwidth of the TDS 684A and TDS 784A Oscilloscopes, order the P6245 Active Probe. See *Appendix A: Options and Accessories* in this manual for more information on optional-accessory probes for all three oscilloscope models.

Probe Usage

Be sure you use the appropriate probe for the measurement. For instance, do not use the P6245 Active Probe to measure signals greater than ± 8 volts or with more than ± 10 volts of offset since errors in signal measurement will result. (See the User manual for the probe for more information.) Instead, use a passive probe, such as P6139A passive probe, that allows higher voltage measurements. The P6139A probe is for measurements up to ± 500 volts.



CAUTION. Using the P6245 Active Probe to measure signals greater than ± 40 volts may damage the probe.

Input Coupling

Be sure to choose the proper input coupling and impedance for the probe or other cabling you use to couple signals to your oscilloscope. You should read *Input Impedance Considerations* on page 3–5 for information needed to ensure proper coupling of your input signals.

Putting into Service

To learn how to install, access the front panel, power on, do a self test, and power off the oscilloscope, do the following procedures:

Installation To properly install and power on the oscilloscope, do the following steps:

1. Be sure you have the appropriate operating environment. Specifications for temperature, relative humidity, altitude, vibrations, and emissions are included in the *TDS 684A, TDS 744A, & TDS 784A Performance Verification and Specifications* manual (Tektronix part number 070-8990-xx).
2. Leave space for cooling. Do this by verifying that the air intake and exhaust holes on the sides of the cabinet (where the fan operates) are free of any airflow obstructions. Leave at least 5.1 cm (2 inches) free on each side.



WARNING. To avoid electrical shock, be sure that the power cord is disconnected before checking the fuse.

3. Check the fuse to be sure it is the proper type and rating (see Figure 1–1). You can use either of two fuses. Each fuse requires its own cap (see Table 1–2). The oscilloscope is shipped with the UL approved fuse installed.
4. Check that you have the proper electrical connections. The oscilloscope requires 90 to 250 VAC_{RMS}, continuous range, 45 Hz to 440 Hz, and may require up to 300 W.
5. Connect the proper power cord from the rear-panel power connector (see Figure 1–1) to the power system.

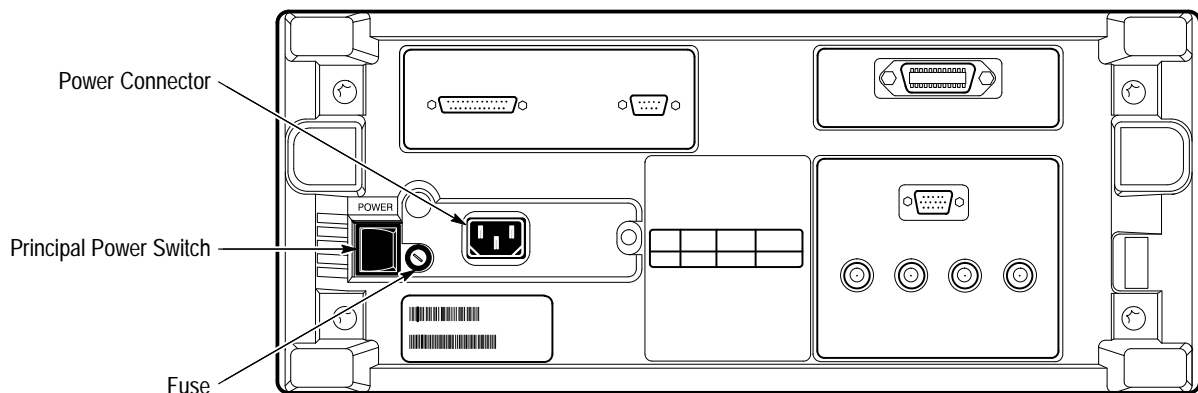

Figure 1–1: Rear Panel Controls Used in Start Up

Table 1-2: Fuse and Fuse Cap Part Numbers

Fuse	Fuse Part Number	Fuse Cap Part Number
0.25 inch × 1.25 inch (UL 198.6, 3AG): 6 A FAST, 250 V.	159-0013-00	200-2264-00
5 mm × 20 mm (IEC 127): 5 A (T), 250 V.	159-0210-00	200-2265-00

Front Cover Removal

To remove the front cover, grasp its left and right edges and snap it off of the front subpanel. (To reinstall it, align it to the front subpanel and snap it back on.)

Power On

To power on the oscilloscope, do the following steps:

1. Check that the rear-panel principal power switch is on (see Figure 1-1). The principal power switch controls all AC power to the instrument.
2. If the oscilloscope is not powered on (the screen is blank), push the front-panel **ON/STBY** button to toggle it on (see Figure 1-2).

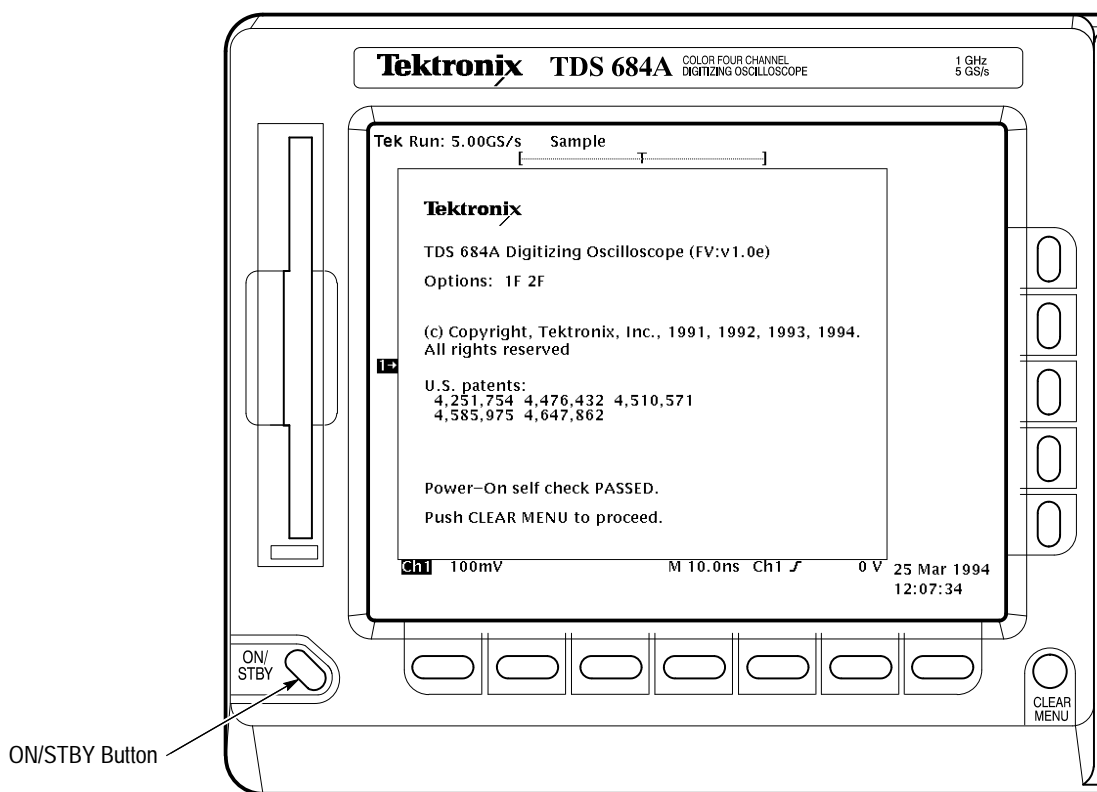

Figure 1-2: ON/STBY Button

The ON/STBY button controls power to most of the instrument circuits. Power continues to go to certain parts even when this switch is set to STBY.

Once the oscilloscope is installed, it is typical to leave the principal power switch on and use the ON/STBY button instead of the power switch.

Self Test The oscilloscope automatically performs power-up tests each time it is turned on. It will come up with a display screen that states whether or not it passed the self test. To determine the self test results, check the screen. (If the self test passed, the status display screen will be removed after a few seconds.)

If the self test fails, call your local Tektronix Service Center. Depending on the type of failure, you may still be able to use the oscilloscope before it is serviced.

Power Off To power off the oscilloscope, toggle the **ON/STBY** switch.

Overview

This chapter describes the basic concepts of operating the TDS Oscilloscope. Understanding the basic concepts of your oscilloscope will help you use it much more effectively.

The first section, *Operating Interface Maps*, quickly shows you how the oscilloscope controls are organized and where you can read about them. It also illustrates the general procedures for operating the menu system. This section includes the titles:

- *Front Panel Map*
- *Rear Panel Map*
- *Display Map*
- *To Operate a Menu*
- *To Operate a Pop-Up Menu*

The second section, *Tutorial*, contains example procedures that lead you through the fundamental tasks needed to display a waveform measurement. It also includes an example procedure that teaches you how to store a setup of the oscilloscope controls for later use. This section includes the following tutorial examples:

- *Setting Up for the Examples*
- *Example 1: Displaying a Waveform*
- *Example 2: Displaying Multiple Waveforms*
- *Example 3: Taking Automated Measurements*
- *Example 4: Saving Setups*

To explore these topics in more depth and to read about topics not covered in this section, see *Reference*. A list of the topics covered begins on Page 3–1.

Operating Interface Maps

This section contains illustrations, or maps, of the display, the front and rear panels, and the menu system of the TDS Oscilloscope. These maps will help you understand and operate the oscilloscope. This section also contains a visual guide to using the menu system.

Front Panel Map — Left Side

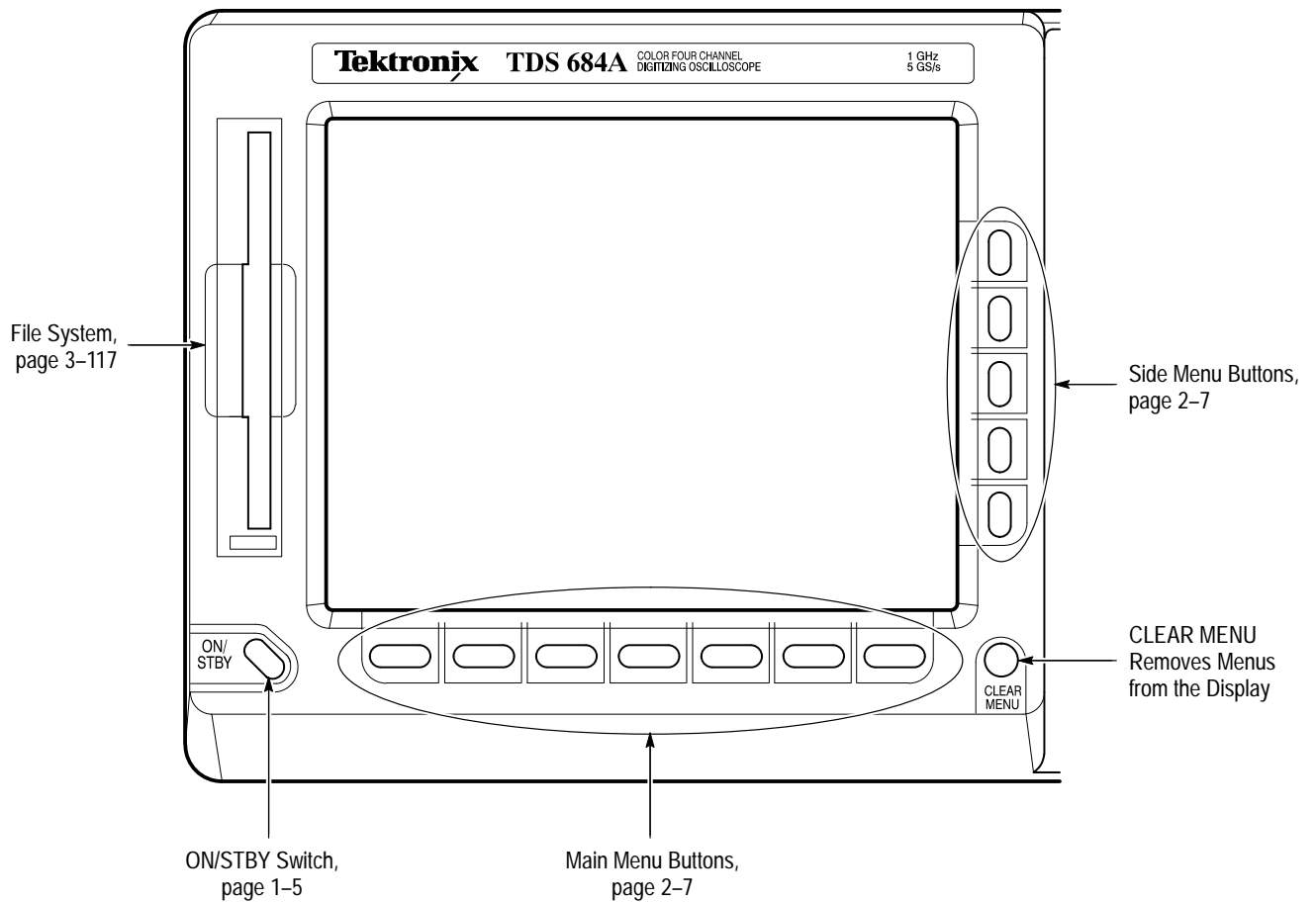

Front Panel Map — Right Side

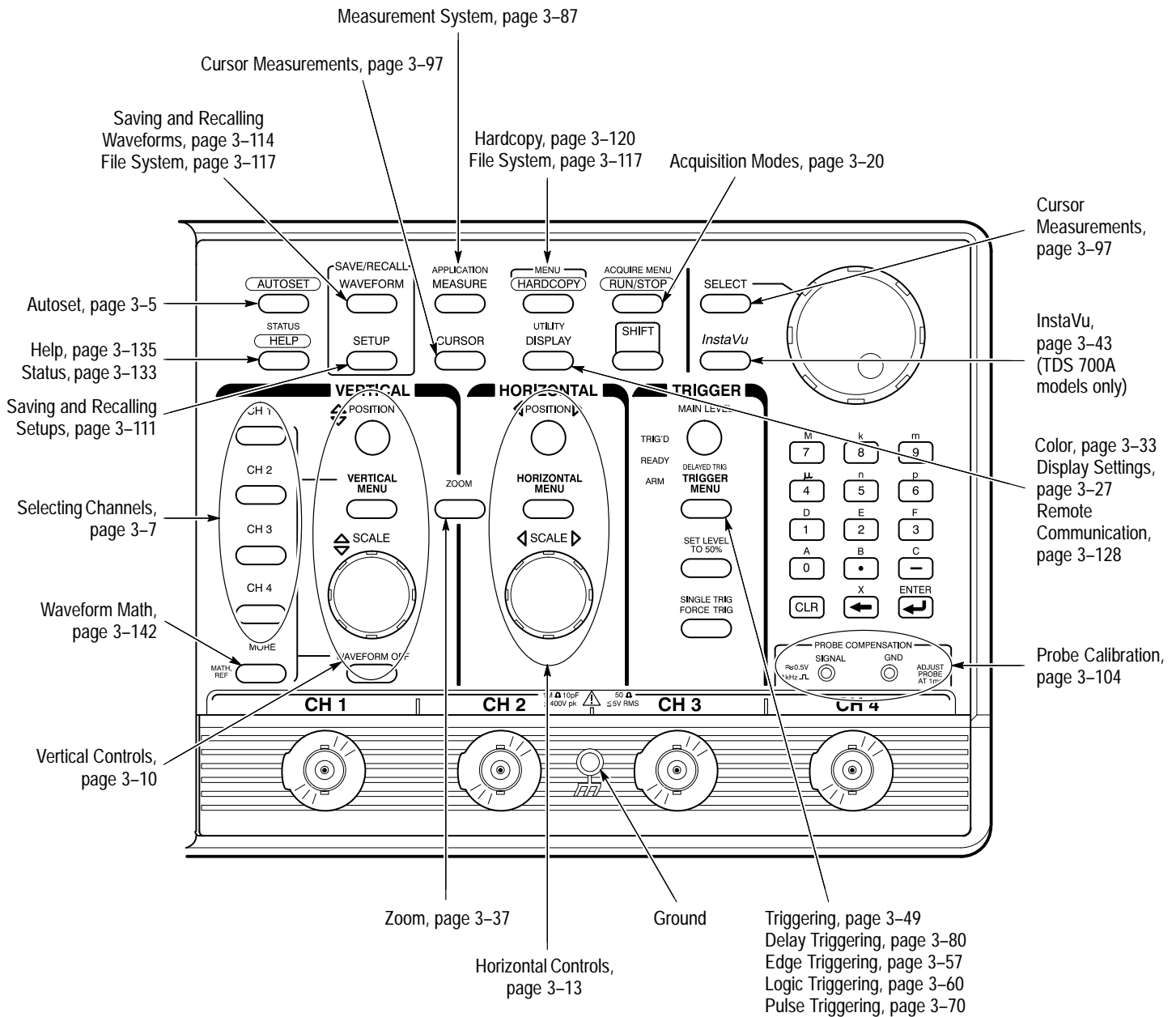

Rear Panel Map

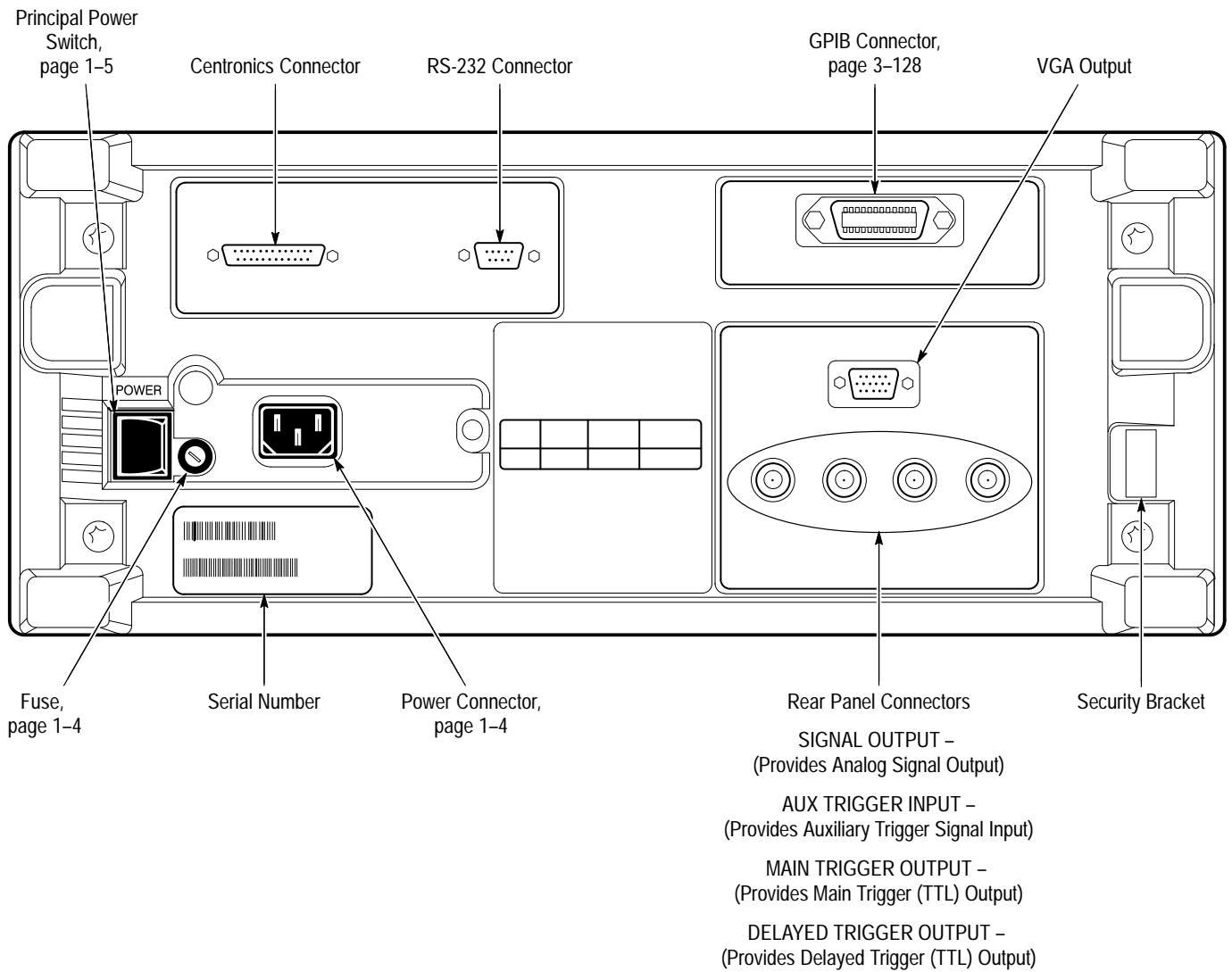

Display Map

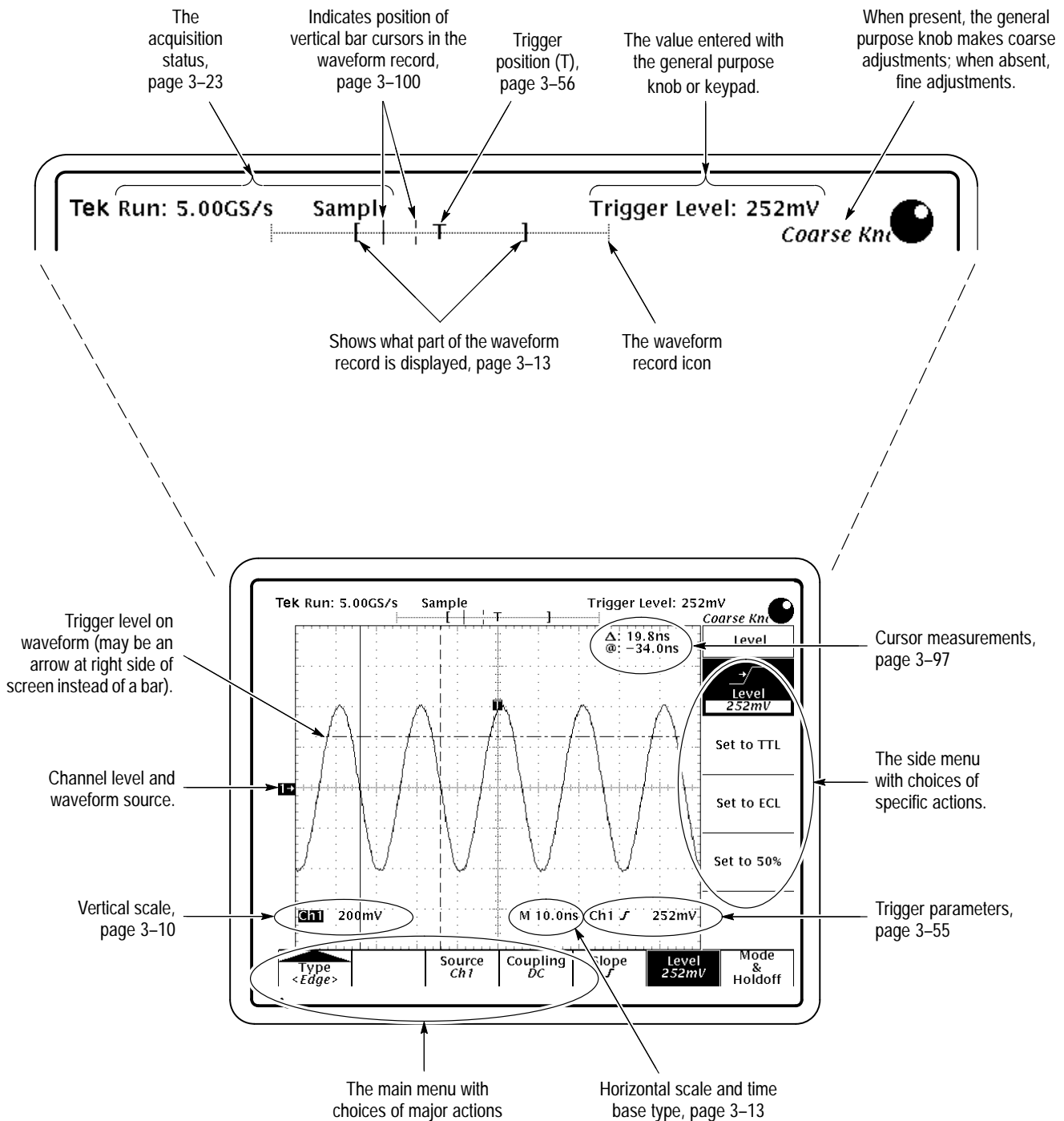

To Operate a Menu

- 1 Press front-panel menu button. (Press **SHIFT** first if button label is blue.)

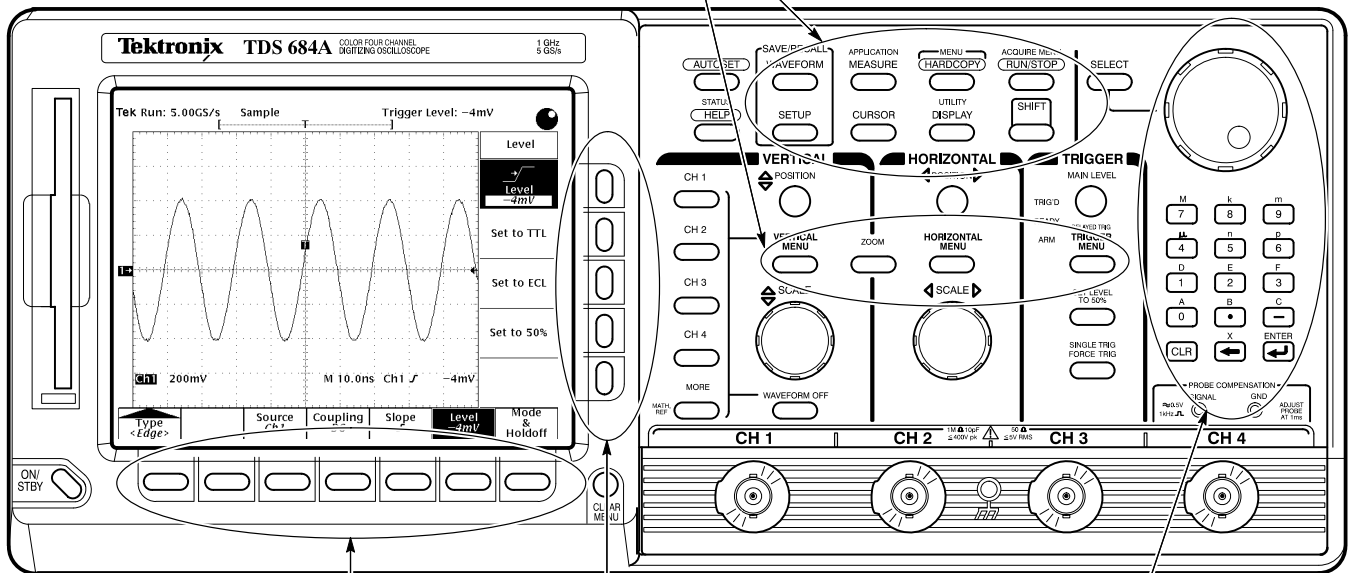

- 2 Press one of these buttons to select from main menu.
- 3 Press one of these buttons to select from side menu (if displayed).
- 4 If side menu item has an adjustable value (shown in reverse video), adjust it with the general purpose knob or keypad.

To Operate a Pop-Up Menu

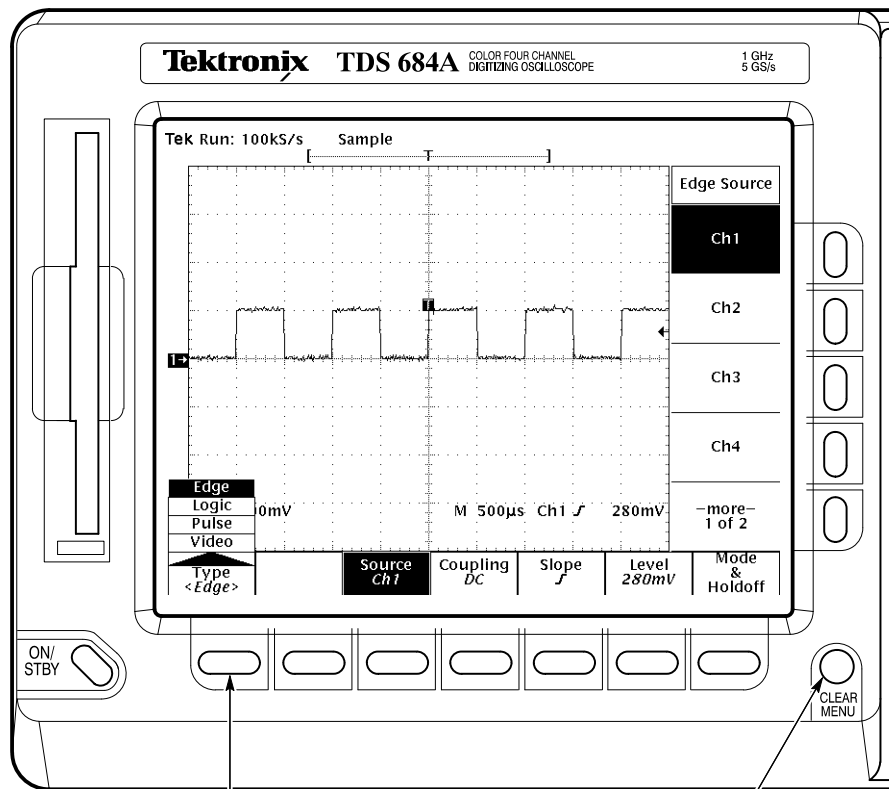

Press to display pop-up menus.

Press it again
to make selection.

Press here to
remove menus from
screen.

Alternatively, press SHIFT first to make
selection in the opposite direction.

A pop-up selection changes the other
main menu titles.

Tutorial

This section quickly makes you acquainted with some of the fundamental operations required to use the TDS Oscilloscope to take measurements. Start this tutorial by doing *Setting Up for the Examples* on this page.

Setting Up for the Examples

Perform the following tasks to connect input signals to the TDS Oscilloscope, to reset it, and to become acquainted with its display screen. Once completed, these tasks ready the oscilloscope for use in the examples that follow.

Connect the Input Signal

Remove all probes and signal inputs from the input BNC connectors along the lower right of the front panel. Then, using an appropriate probe (such as the P6245), connect from the **CH 1** connector of the oscilloscope to the **PROBE COMPENSATION** connectors. (See Figure 2–1.)

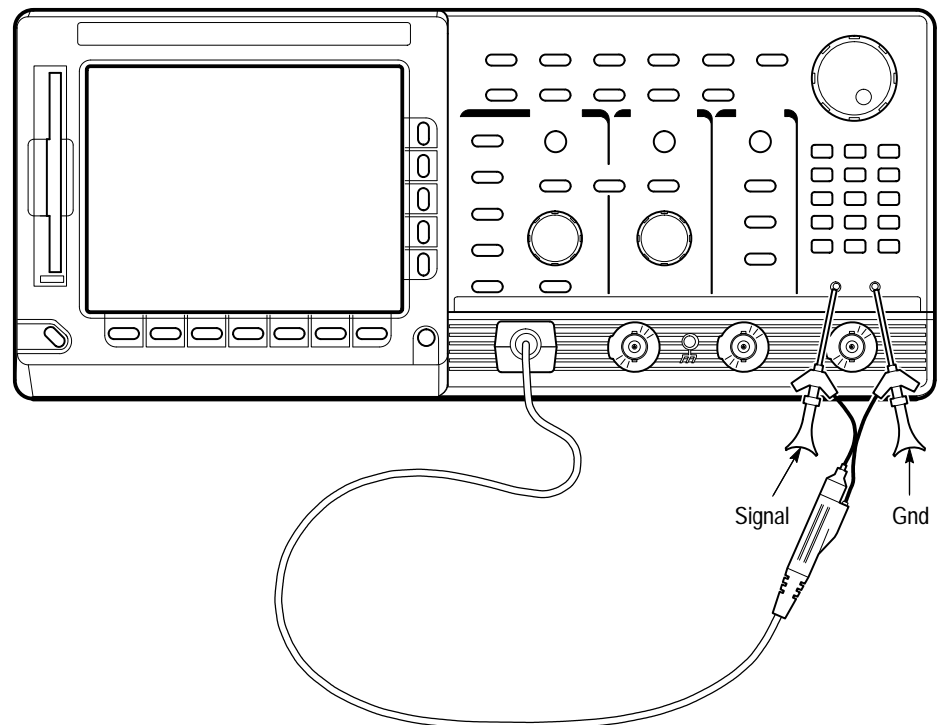

Figure 2–1: Connecting a Probe for the Examples (P6245 shown)

NOTE. See Appendix A: Options and Accessories for optional probes you can order and use with this product.

Reset the Oscilloscope

Do the following steps to reset the oscilloscope to a known factory default state before doing the examples. (You can reset the oscilloscope anytime you begin a new task and need to “start fresh” with known default settings.)

1. Press the save/recall **SETUP** button to display the Setup menu. (See Figure 2–2.)

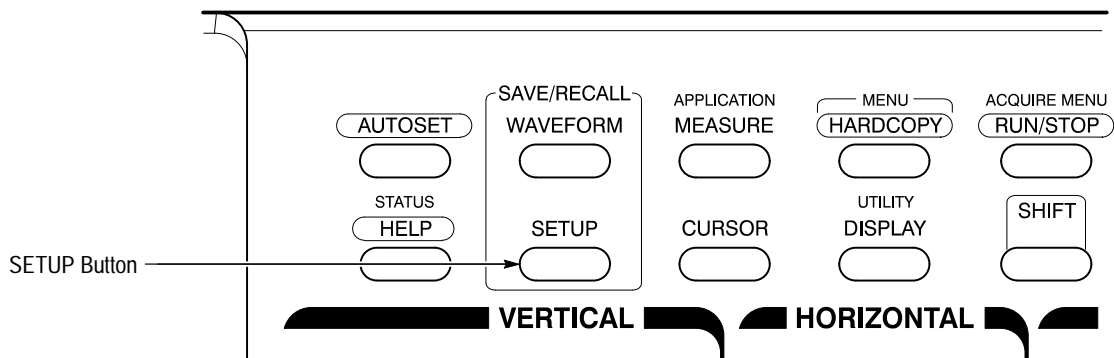

Figure 2–2: SETUP Button Location

The oscilloscope displays *main menus* along the bottom of the screen. Figure 2–3 shows the Setup main menu.

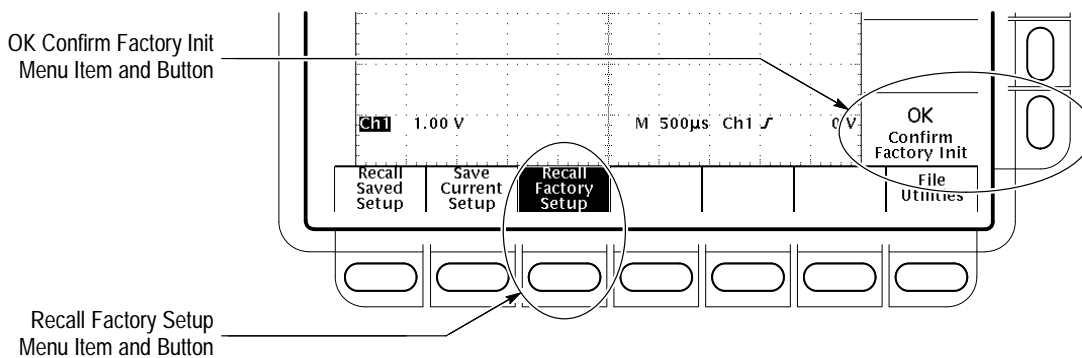

Figure 2–3: The Setup Menu

2. Press the button directly below the **Recall Factory Setup** menu item.

The display shows *side menus* along the right side of the screen. The buttons to select these side menu items are to the right of the side menu.

Because an accidental instrument reset could destroy a setup that took a long time to create, the oscilloscope asks you to verify the Recall Factory Setup selection. (See Figure 2–3.)

3. Press the button to the right of the **OK Confirm Factory Init** side menu item.

NOTE. This manual uses the following notation to represent the sequence of selections you made in steps 1, 2 and 3: Press save/recall **SETUP → Recall Factory Setup** (main) → **OK Confirm Factory Init** (side).



Note that a clock icon appears on screen. The oscilloscope displays this icon when performing operations that take longer than several seconds.

4. Press **SET LEVEL TO 50%** (see Figure 2–4) to be sure the oscilloscope triggers on the input signal.

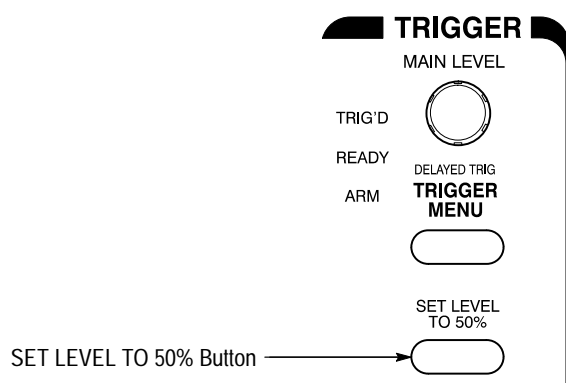

Figure 2–4: Trigger Controls

Examine the Display Elements

Read the following information to become familiar with the oscilloscope display before doing the examples.

Figure 2–5 shows the display that results from the oscilloscope reset. There are several important points to observe:

- The *trigger level bar* shows that the waveform is triggered at a level near 50% of its amplitude (from step 4).
- The *trigger position indicator* shows that the trigger position of the waveform is located at the horizontal center of the graticule.

- The *channel reference indicator* shows the vertical position of channel 1 with no input signal. This indicator points to the ground level for the channel when its vertical offset is set to 0 V in the vertical menu; when vertical offset is *not* set to 0 V, it points to the vertical offset level.
- The *trigger readout* shows that the oscilloscope is triggering on channel 1 (Ch1) on a rising edge, and that the trigger level is about 200–300 mV.
- The *time base readout* shows that the main time base is set to a horizontal scale of 500 $\mu\text{s}/\text{div}$.
- The *channel readout* indicates that channel 1 (Ch1) is displayed with DC coupling. (In AC coupling, ~ appears after the volts/div readout.) The oscilloscope always displays channel 1 at reset.

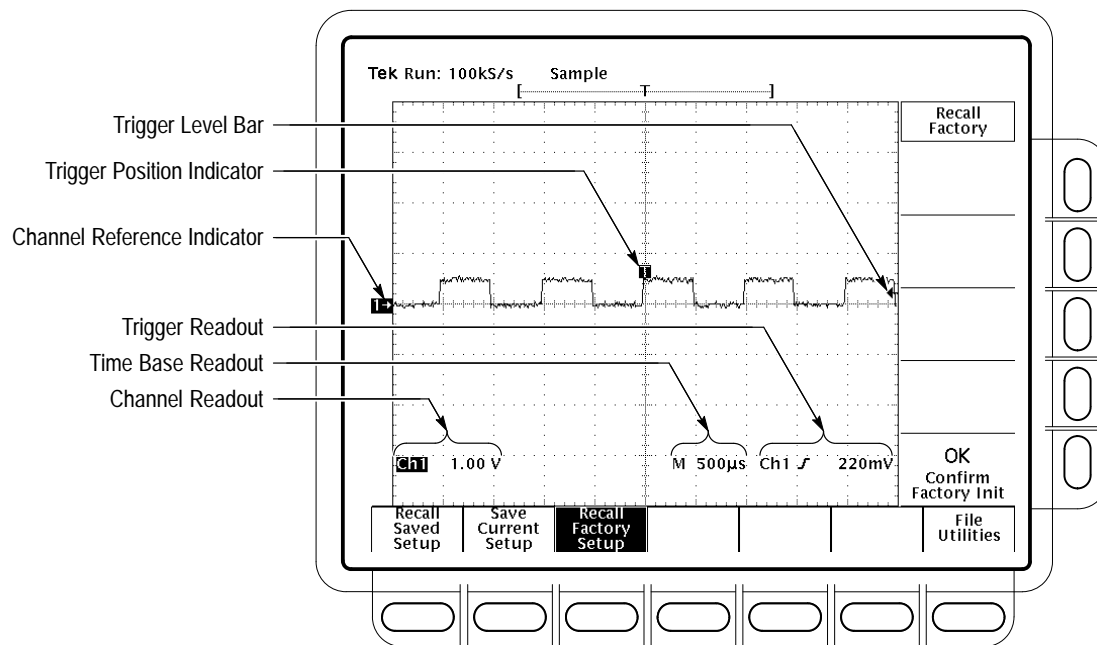

Figure 2-5: The Display After Factory Initialization

Right now, the channel, time base, and trigger readouts appear in the graticule area because a menu is displayed. You can press the CLEAR MENU button at any time to remove any menus and to move the readouts below the graticule.

Example 1: Displaying a Waveform

The TDS Oscilloscope provides front panel knobs for you to adjust a waveform, or it can automatically set up its controls to display a waveform. Do the following tasks to learn how to adjust a waveform and how to autoset the TDS Oscilloscope.

Adjust the Waveform Display

The display shows the probe compensation signal. It is a 1 kHz square wave of approximately 0.5 V amplitude.

Figure 2–6 shows the main VERTICAL and HORIZONTAL sections of the front panel. Each has SCALE and POSITION knobs. Do the following steps to adjust the size and placement of the waveform using the front-panel knobs:

1. Turn the vertical **SCALE** knob clockwise. Observe the change in the displayed waveform and the channel readout at the bottom of the display.

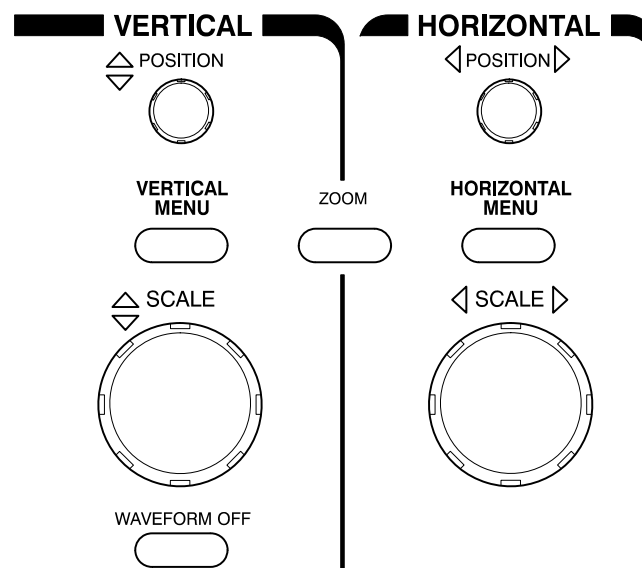

Figure 2–6: The VERTICAL and HORIZONTAL Controls

2. Turn the vertical **POSITION** knob first one direction, and then the other. Observe the change in the displayed waveform. Then return the waveform to the center of the graticule.
3. Turn the horizontal **SCALE** knob one click clockwise. Observe the time base readout at the bottom of the display. The time base should be set to 200 $\mu\text{s}/\text{div}$ now, and you should see two complete waveform cycles on the display.

Autoset the Oscilloscope

When you first connect a signal to a channel and display it, the signal displayed may not be scaled and triggered correctly. Use the autoset function and you should quickly get a meaningful display.

You should have a stable display of the probe compensation waveform from the last step. Do the following steps to first create an unstable display and then to autoset the display:

1. To create an unstable display, slowly turn the trigger **MAIN LEVEL** knob (see Figure 2–7) first one direction, and then the other. Observe what happens when you move the trigger level above the highest part of the waveform. Leave the trigger level in that untriggered state.

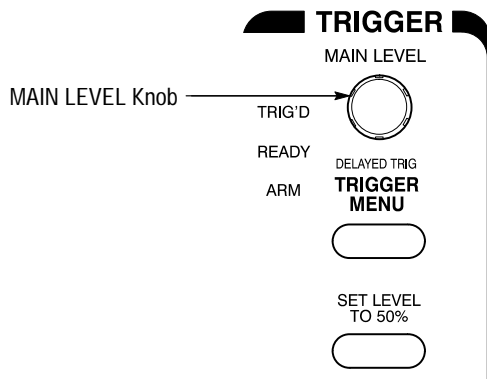

Figure 2–7: TRIGGER Controls

2. Press **AUTOSET** (see Figure 2–8) and observe the stable waveform display.

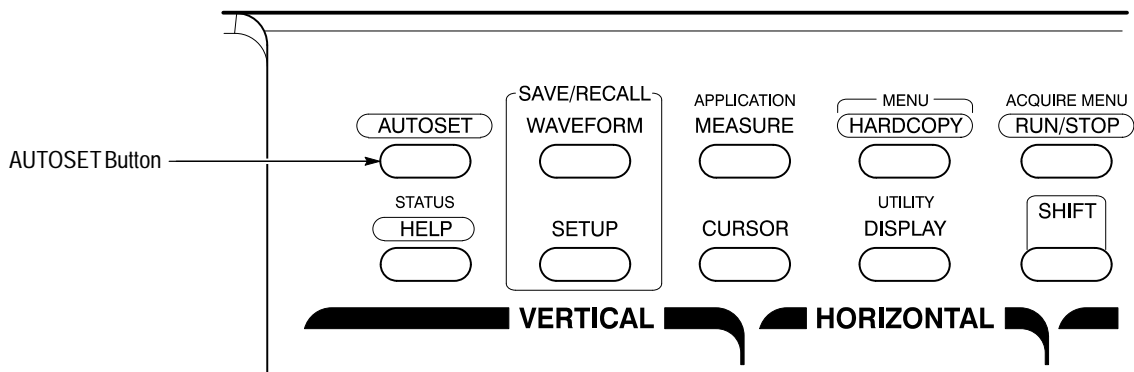

Figure 2–8: AUTOSET Button Location

Figure 2–9 shows the display after pressing AUTOSSET. If necessary, you can adjust the waveform now by using the knobs discussed earlier in this example.

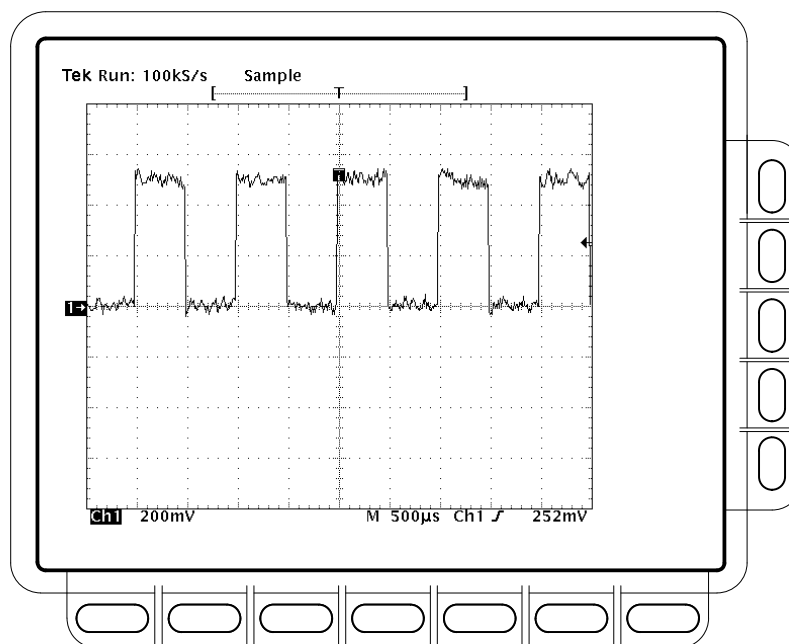

Figure 2–9: The Display After Pressing Autoset

NOTE. If you are using a passive probe, such as the P6139A probe, the corners on your displayed signal may look rounded or pointed. (See Figure 2–10.) If so, then you may need to compensate your probe. See To Compensate Passive Probes on page 3–3.



Figure 2–10: Display Signals Requiring Probe Compensation

Example 2: Displaying Multiple Waveforms

The TDS Oscilloscope can display up to four channels, three math waveforms, and four reference waveforms at one time. Do the following tasks to learn how to display and control more than one waveform at a time.

Add a Waveform

The VERTICAL section of the front panel contains the channel selection buttons. These buttons are CH 1, CH 2, CH 3, CH 4, and MORE. (See Figure 2–11.)

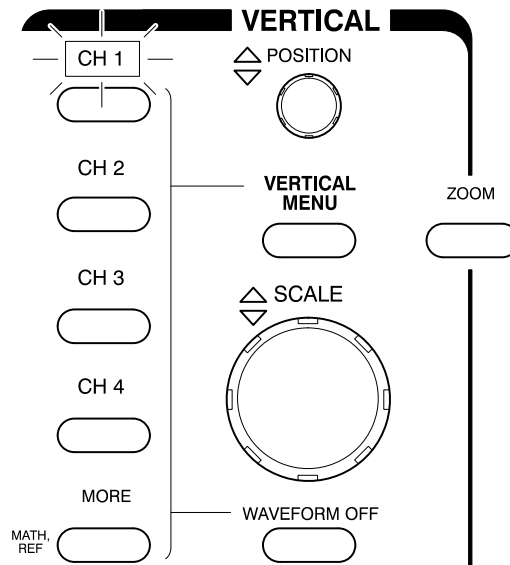

Figure 2–11: The Channel Buttons and Lights

Each of the channel (CH) buttons has a light behind its label. Right now, the CH 1 light is on. That light indicates that the vertical controls are set to adjust channel 1. Do the following steps to add a waveform to the display:

1. If you are not continuing from the previous example, follow the instructions on page 2–9 under the heading *Setting Up for the Examples*.
2. Press **SETUP** → **Recall Factory Setup** (main) → **OK Confirm Factory Init** (side).
3. Press **AUTOSET**.
4. Press **CH 2**.

The display shows a second waveform, which represents the signal on channel 2. Since there is nothing connected to the CH 2 input connector, this waveform is a flat line. There are several other important things to observe:

- The channel readout on the display now shows the settings for both Ch1 and Ch2.
- There are two channel indicators at the left edge of the graticule. Right now, they overlap.

- The light above the CH 2 button is now on, and the CH 1 light is off. Because the knobs control only one channel at a time, the vertical controls are now set to adjust channel 2.
 - The trigger readout still indicates that the trigger is detecting trigger events on Ch1. The trigger source is not changed simply by adding a channel. (You can change the trigger source by using the TRIGGER MENU button to display the trigger menu.)
5. Turn the vertical **POSITION** knob clockwise to move the channel 2 waveform up on the graticule. You will notice that the channel reference indicator for channel 2 moves with the waveform.
 6. Press **VERTICAL MENU** → **Coupling** (main).

The VERTICAL MENU button displays a menu that gives you control over many vertical channel parameters. (See Figure 2–12.) Although there can be more than one channel displayed, the vertical menu and buttons only adjust the selected channel.

Each menu item in the Vertical menu displays a side menu. Right now, the Coupling item in the main menu is highlighted, which means that the side menu shows the coupling choices. At the top of the side menu, the menu title shows the channel affected by the menu choices. That channel always matches the lighted channel button.

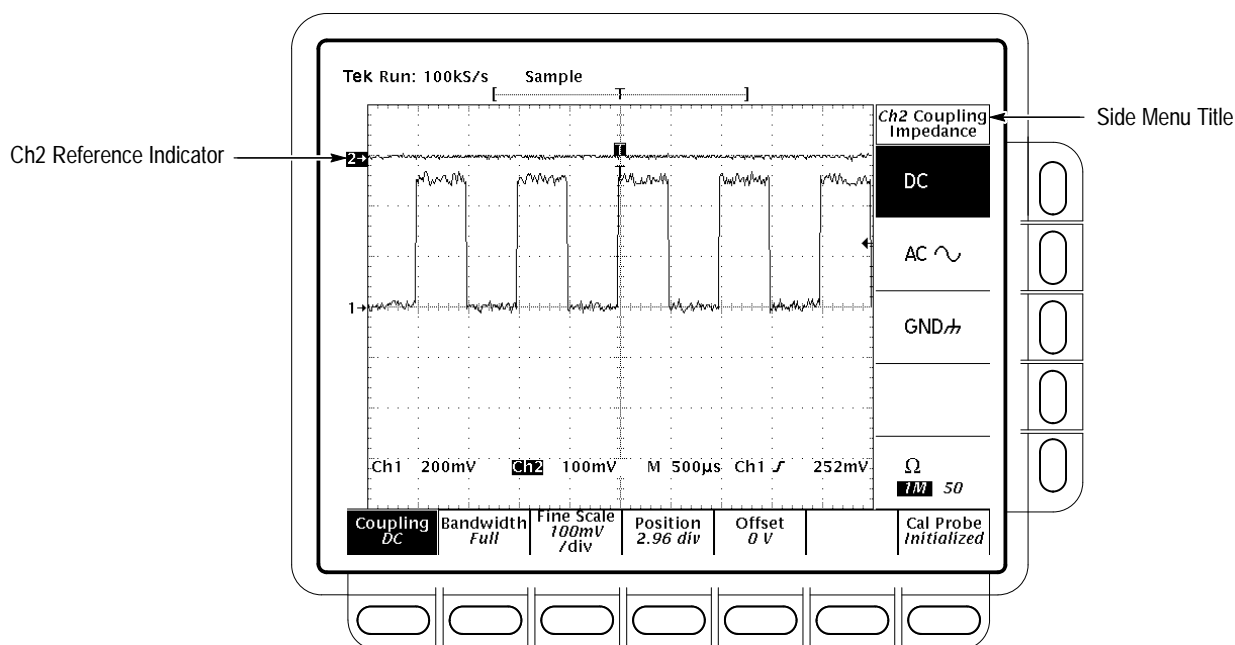

Figure 2–12: The Vertical Main Menu and Coupling Side Menu

- Press Ω (side) to toggle the selection to **50 Ω** . That changes the input coupling of channel 2 from 1 M Ω to 50 Ω . The channel readout for channel 2 (near the bottom of the graticule) now shows an Ω indicator.

Assign Controls to Another Channel

Pressing a channel (CH) button sets the vertical controls to that channel. It also adds the channel to the display if that waveform is not already displayed. To explore assigning controls to different channels, do the following steps:

- Press **CH 1**.

Observe that now the side menu title shows Ch1. (See Figure 2–13), and that the light above CH 1 is lit. The highlighted menu item in the side menu has changed from the 50 Ω channel 2 setting to the 1 M Ω impedance setting of channel 1.

- Press **CH 2** \rightarrow Ω (side) to toggle the selection to **1 M Ω** . That returns the coupling impedance of channel 2 to its initial state.

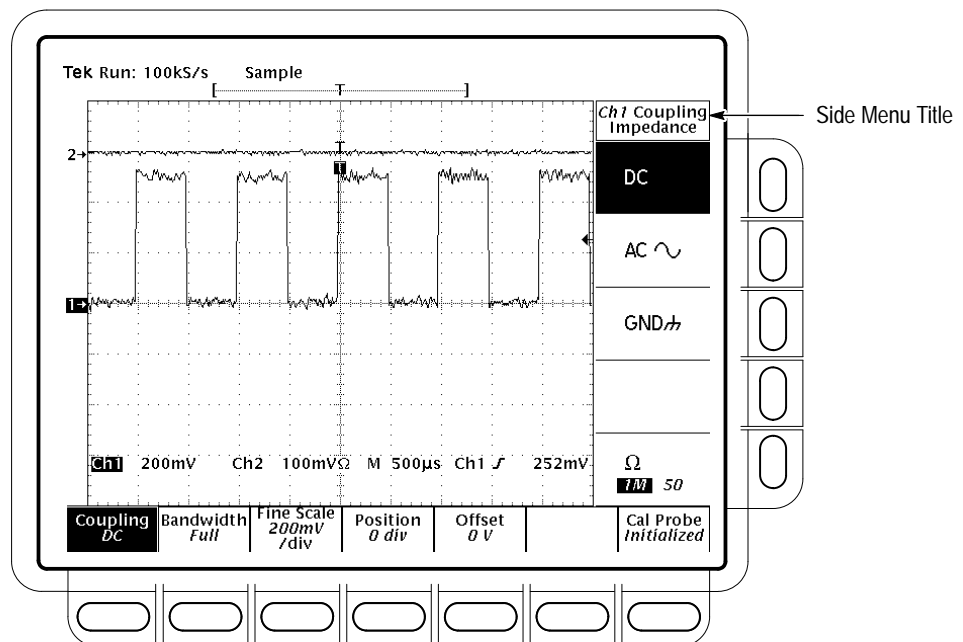

Figure 2–13: The Menus After Changing Channels

Remove a Waveform

Pressing the WAVEFORM OFF button removes the waveform for the currently selected channel. If the waveform you want to remove is not already selected, select that channel using the channel (CH) button.

- Press **WAVEFORM OFF** (under the vertical **SCALE** knob).

Since the CH 2 light was on when you pressed the WAVEFORM OFF button, the channel 2 waveform was removed.

The channel (CH) lights now indicate channel 1. Channel 1 has become the selected channel. When you remove the last waveform, all the CH lights are turned off.

2. Press **WAVEFORM OFF** again to remove the channel 1 waveform.

Example 3: Taking Automated Measurements

The TDS Oscilloscope can measure many waveform parameters automatically and read out the results on screen. Do the following tasks to discover how to set up the oscilloscope to measure waveforms automatically.

Display Measurements Automatically

To use the automated measurement system, you must have a stable display of your signal. Also, the waveform must have all the segments necessary for the measurement you want. For example, a rise time measurement requires at least one rising edge, and a frequency measurement needs at least one complete cycle. To take automated measurements, do the following steps:

1. If you are not continuing from the previous example, follow the instructions on page 2–9 under the heading *Setting Up for the Examples*.
2. Press **SETUP** → **Recall Factory Setup** (main) → **OK Confirm Factory Init** (side).
3. Press **AUTOSET**.
4. Press **MEASURE** to display the Measure main menu. (See Figure 2–14.)
5. If it is not already selected, press **Select Measrmnt** (main). The readout for that menu item indicates which channel the measurement will be taken from. All automated measurements are made on the selected channel.

The Select Measurement side menu lists some of the measurements that can be taken on waveforms. There are many different measurements available; up to four can be taken and displayed at any one time. Pressing the button next to the **–more–** menu item brings up the other measurement selections.



6. Press **Frequency** (side). If the **Frequency** menu item is not visible, press **–more–** (side) repeatedly until the **Frequency** item appears. Then press **Frequency** (side).

Observe that the frequency measurement appears within the right side of the graticule area. The measurement readout includes the notation **Ch1**, meaning that the measurement is taken on the channel 1 waveform. (To take a

measurement on another channel, select that channel, and then select the measurement.)

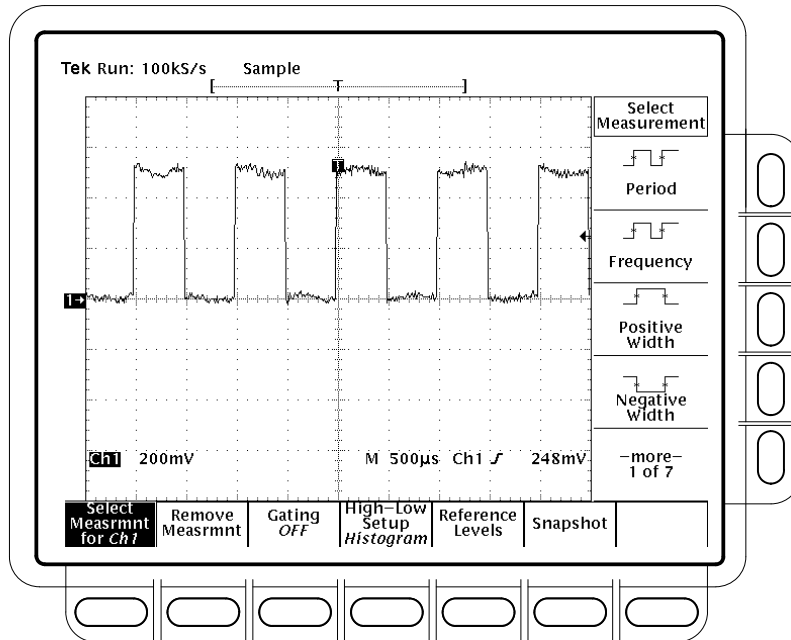
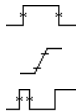

Figure 2-14: Measure Main Menu and Select Measurement Side Menu



7. Press **Positive Width** (side) → **–more–** (side) → **Rise Time** (side) → **Positive Duty Cycle** (side).

All four measurements are displayed. Right now, they cover a part of the graticule area, including the displayed waveforms.

8. To move the measurement readouts outside the graticule area, press **CLEAR MENU**. (See Figure 2-15.)

Remove Measurement Readouts

Use the Measure menu to remove waveforms you no longer want. To remove a measurement individually (you can also remove them, as a group), do the following step:

1. Press **MEASURE** → **Remove Measrmt** (main) → **Measurement 1**, **Measurement 2**, and **Measurement 4** (side) to remove those measurements. Leave the rise time measurement displayed.

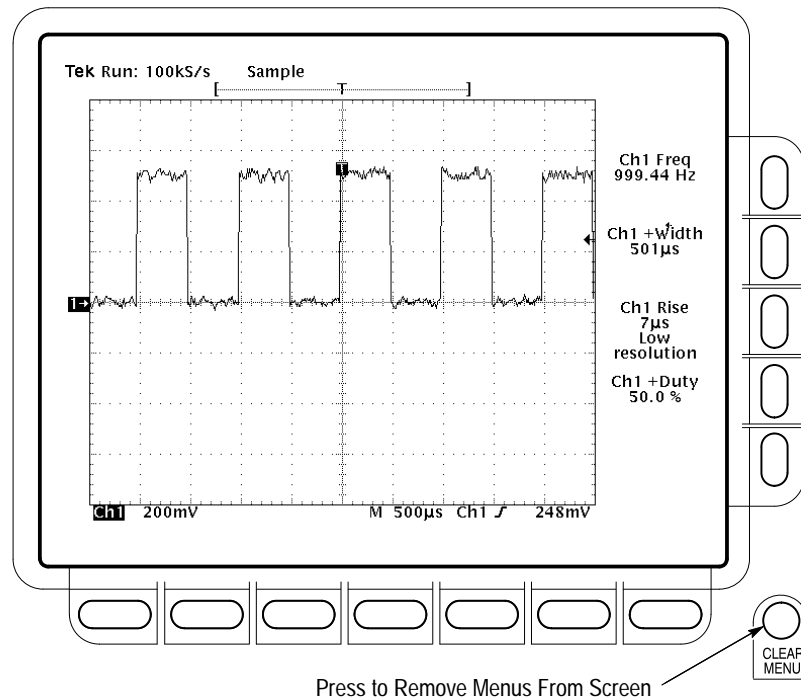

Figure 2-15: Four Simultaneous Measurement Readouts

Change the Measurement Reference Levels



By default, the measurement system will use the 10% and 90% levels of the waveform for taking the rise time measurement. You can change these values to other percentages or change them to absolute voltage levels.

To examine the current values, press **Reference Levels** (main) → **High Ref** (side).

The General Purpose Knob. The general purpose knob, the large knob, is now set to adjust the high reference level (Figure 2-16.)

There are several important things to observe on the screen:

- The knob icon appears at the top of the screen. The knob icon indicates that the general purpose knob has just been set to adjust a parameter.
- The upper right corner of the screen shows the readout High Ref: 90%.
- The High Ref side menu item is highlighted, and a box appears around the 90% readout in the High Ref menu item. The box indicates that the general purpose knob is currently set to adjust that parameter.

Turn the general purpose knob left and right, and then use it to adjust the high level to 80%. That sets the high measurement reference to 80%.

Hint: To make large changes quickly with the general purpose knob, press the **SHIFT** button before turning the knob. When the light above the **SHIFT** button is on and the display says *Coarse Knobs* in the upper-right corner, the general purpose knob speeds up significantly.

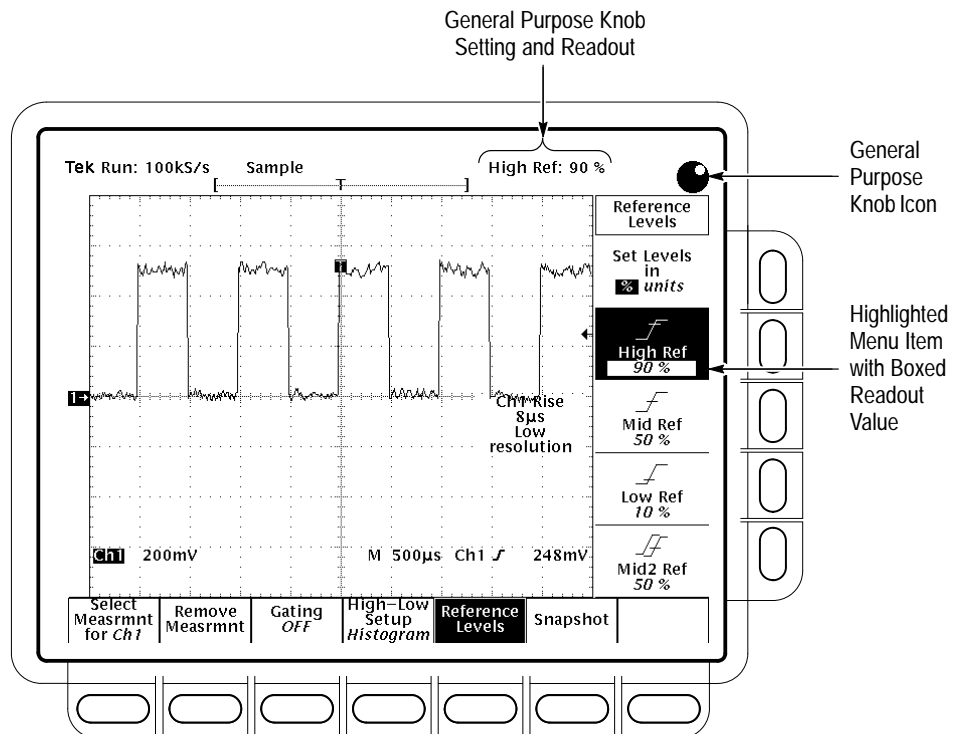

Figure 2-16: General Purpose Knob Indicators

The Numeric Keypad. Any time the general purpose knob is set to adjust a numeric parameter, you can enter the value as a number using the keypad instead of using the knob. Always end the entry of a number by pressing ENTER (↵).

The numeric keypad also provides multipliers for engineering exponents, such as m for milli, M for mega, and μ for micro. To enter these multiplier values, press the SHIFT button, and then press the multiplier.



1. Press **Low Ref** (side).
2. On the numeric keypad, press the **2**, the **0**, and the **ENTER** (↵) buttons, which sets the low measurement reference to 20%. Observe that the rise-time value has changed.
3. Press **Remove Measrmt** (main) → **All Measurements** (side). That returns the display to its original state.

Displaying a Snapshot of Automated Measurements

You have seen how to display up to four individual automated measurements on screen. You can also pop up a display of almost all of the automated measurements available in the Select Measrmnts side menu. This snapshot of measurements is taken on the waveform currently selected using the channel selection buttons.

As when displaying individual measurements, you must have a stable display of your signal, and that signal must have all the segments necessary for the measurement you want.

1. Press **Snapshot** (main) to pop up a snapshot of all available single waveform measurements. (See Figure 2–17.)

The snapshot display includes the label Ch 1, meaning that the measurements displayed are taken on the channel 1 waveform. You take a snapshot of a waveform in another channel by first selecting that channel using the channel selection buttons.

The snapshot measurements do not continuously update. Snapshot executes a one-time capture of all measurements and does not update those measurements unless it is performed again.

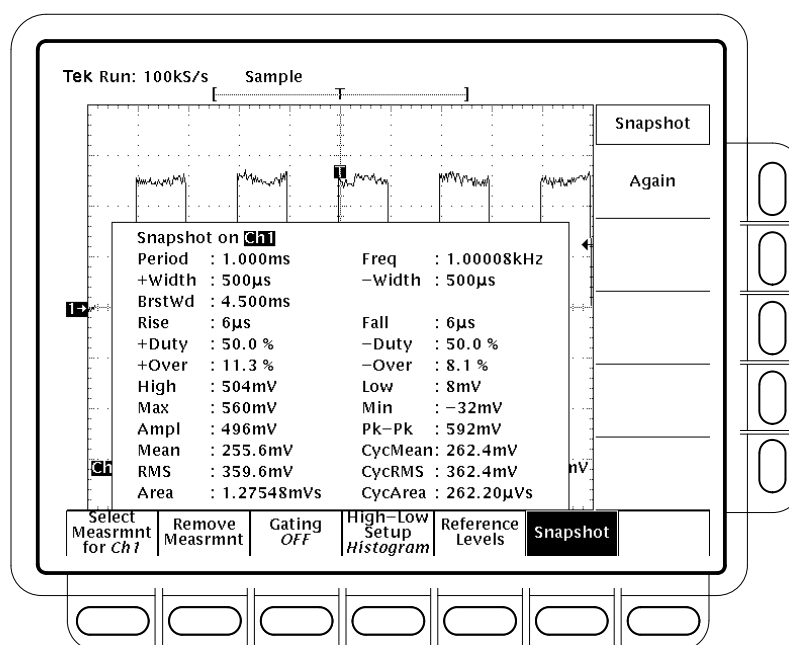

Figure 2–17: Snapshot of Channel 1

2. Press **Again** (side) to do another snapshot and update the snapshot measurements.

3. Press **Remove Measrmt** (main) to remove the snapshot display. (You can also press **CLEAR MENU**, but a new snapshot will be executed the next time you display the Measure menu.)

Example 4: Saving Setups

The TDS Oscilloscope can save its controls settings and recall them later to quickly re-establish a setup. It provides ten storage locations to store up to ten setups. It also provides a file system, so that you can also save setups to a floppy disk. Do the following procedures to learn how to save, and then recall, a setup.

NOTE. Besides being able to save several complete setups, the oscilloscope remembers all the parameter settings when you power it off. That feature lets you power on and continue where you left off without having to reconstruct the setup in effect when you powered off the oscilloscope.

Save a Setup

First, you need to create an instrument setup you want to save. Perform the following steps to create and save a setup that is complex enough that you might prefer not to go through all these steps each time you want that display:

1. If you are not continuing from the previous example, follow the instructions on page 2–9 under the heading *Setting Up for the Examples*.
2. Press **SETUP** → **Recall Factory Setup** (main) → **OK Confirm Factory Init** (side).
3. Press → **AUTOSET**.
4. Press **MEASURE** → **Select Measrmt** (main) → **Frequency** (side). (Press the **–more–** side menu item if the **Frequency** selection does not appear in the side menu.)
5. Press **CH 2** → **CLEAR MENU**.
6. Press **SAVE/RECALL SETUP** → **Save Current Setup** (main) to display the Setup main menu. (See Figure 2–18.)



CAUTION. Setup locations in the side menu appear with the label *user* if they contain a stored setup or with the label *factory* if they do not. To avoid overwriting (and losing forever) a saved setup, choose a setup location labeled *factory*. (Setup locations labeled *factory* have the factory setup stored as a default and can be used to store current setups without disturbing previously stored setups.)

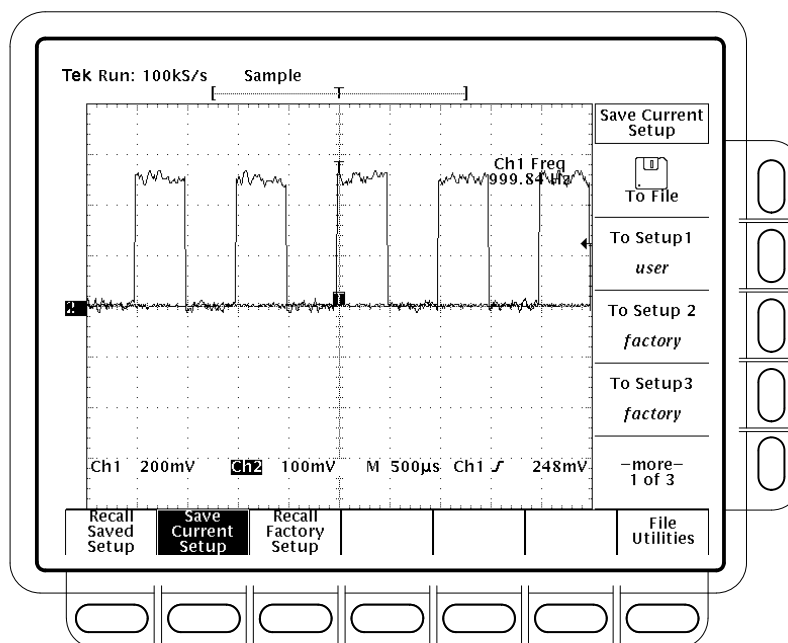

Figure 2-18: Save/Recall Setup Menu

7. Press one of the **To Setup** side menu buttons to store the current instrument settings into that setup location. Remember which setup location you selected for use later.

There are more setup locations than can be listed at one time in the side menu. The **-more-** side menu item gives you access to all the setup locations.

Once you have saved a particular setup, you can change the settings as you wish, knowing that you can come back to that setup at any time.



8. Press **MEASURE** → **Positive Width** (side) to add that measurement to the display.

Recall a Setup

To recall the setup, press **SAVE/RECALL SETUP** → **Recall Saved Setup** (main) → **Recall Setup** (side) for the setup location you used in the last exercise. The positive width measurement is now removed from the display because you selected it after you saved the setup.

The step just performed completes the examples. You can restore the default settings by pressing **SETUP** → **Recall Factory Setup** (main) → **OK Confirm Factory Init** (side).

Overview

This chapter describes in detail how to perform the operating tasks you must do to measure, test, process, or save and document your waveforms. It leads with three sections on the fundamental tasks of acquiring, stably displaying, and taking measurements on waveforms:

- *Acquiring and Displaying Waveforms*
- *Triggering on Waveforms*
- *Measuring Waveforms*

Once you have acquired and measured waveforms, you may want to save and restore them or the control setups used to acquire and measure them. Or you may want to save the display screen, complete with waveform and setup information, to include them with the documents you produce with your desk top publishing system. You may even want to digitally process them (add, multiply, or divide them; integrate, differentiate or take an FFT of them). The following two topics cover these tasks:

- *Saving Waveforms and Setups*
- *Using Features for Advanced Applications*

When performing any operation task, you might want to display a comprehensive listing of its current control settings on screen. Or you may find it handy to display operating information about front panel controls and menus instead of looking them up in this manual. The following topic tells you how to do both:

- *Determining Status and Accessing Help*

The topics just listed contain steps that you perform to accomplish the task that the topic defines. You should read *Conventions* on page xiv of *Preface* before reading about these tasks.

Each topic just listed comprises more basic operation tasks and topics. A list of these tasks follows.

Acquiring and Displaying Waveforms	Coupling Waveforms to the Oscilloscope	3–3
	Setting up Automatically: Autoset and Reset	3–5
	Selecting Channels	3–7
	Scaling and Positioning Waveforms	3–9
	Choosing an Acquisition Mode	3–16
	Customizing the Display	3–27
	Customizing the Display Color	3–33

	Zooming on Waveforms	3-37
	Using InstaVu™ Acquisition Mode (TDS 700A Models Only)	3-43
	Using FastFrame™ (TDS 700A Models Only)	3-46
Triggering on Waveforms	Triggering Concepts	3-49
	Triggering from the Front Panel	3-53
	Triggering on a Waveform Edge	3-57
	Triggering Based on Logic	3-60
	Triggering on Pulses	3-70
	Delayed Triggering	3-80
Measuring Waveforms	Taking Automated Measurements	3-87
	Taking Cursor Measurements	3-97
	Taking Graticule Measurements	3-101
	Optimizing Measurement Accuracy: SPC and Probe Cal	3-102
Saving Waveforms and Setups	Saving and Recalling Setups	3-111
	Saving and Recalling Waveforms	3-114
	Managing the File System	3-117
	Printing a Hardcopy	3-120
	Communicating with Remote Instruments	3-128
Determining Status and Accessing Help	Displaying Status	3-133
	Displaying Help	3-135
Using Features for Advanced Applications	Limit Testing	3-137
	Waveform Math	3-142
	Fast Fourier Transforms	3-144
	Waveform Differentiation	3-161
	Waveform Integration	3-165

Acquiring and Displaying Waveforms

To use the TDS Oscilloscope to measure or monitor waveforms, you need to know how to acquire, select, and display those waveforms properly. To help you do so, this section describes how to do the following tasks:

- How to couple waveforms to the oscilloscope channels
- How to select channels to turn on and off their display
- How to size and position the selected channel on screen
- How to use the menus to set vertical (coupling, offset, and bandwidth) and horizontal (time base, record length, and so on) parameters

This section also describes how to choose the appropriate acquisition mode for acquiring your waveform, how to customize the display (including selecting the color of the display elements), and how to use the *Zoom*, *FastFrame*, and *InstaVu* features.

Coupling Waveforms to the Oscilloscope

Tektronix produces a variety of probes and cables suitable for connecting various types of signals to the input channels of this product. This subsection covers two topics important to coupling: *Probe Compensation* and *Input Impedance Considerations*.

Tektronix ships the P6139A passive probe with the TDS 744A Oscilloscope as a standard accessory. The TDS 684A and TDS 784A Oscilloscopes ship without standard probes but Tektronix recommends you order the P6245 active probe to take advantage of the 1 GHz bandwidth of these two oscilloscopes.

Tektronix also offers a variety of BNC cabling and connectors to couple a variety of signal sources to its input channels. See your Tektronix Sales representative for the specific items offered for signal coupling.

To Compensate Passive Probes

When using a *passive* probe with any product, compensate it to ensure maximum distortion-free input to the oscilloscope and to avoid high frequency amplitude errors (see Figure 3–1). To compensate your probe, do the following steps:

1. Connect the probe to the probe compensation signal on the front panel.
2. Press **AUTOSET**.
3. Press **VERTICAL MENU** → **Bandwidth** (main) → **20 MHz** (side).

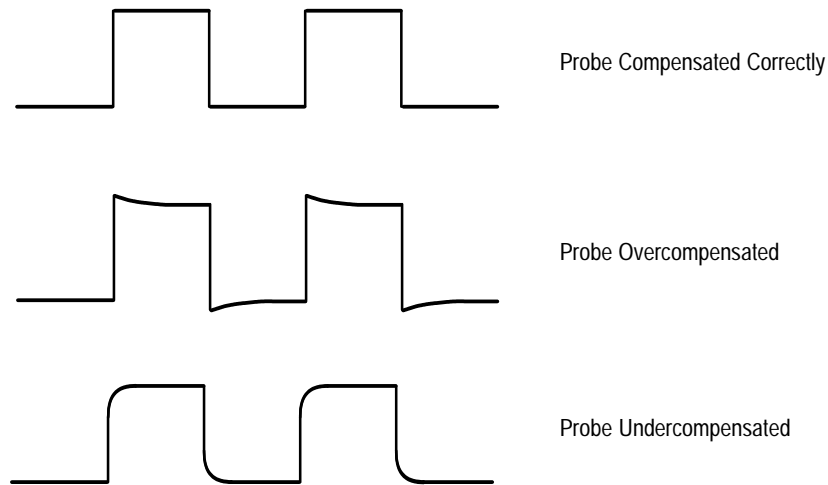

Figure 3-1: How Probe Compensation Affects Signals

4. If you need to change the input impedance, press **Coupling** (main). Then toggle the side menu selection Ω to get the correct impedance.
5. TDS 700A models only: Press **SHIFT ACQUIRE MENU** \rightarrow **Mode** (main) \rightarrow **Hi Res** (side).
6. TDS 684A only: Press **SHIFT ACQUIRE MENU** \rightarrow **Mode** (main) \rightarrow **Average** (side). Use the keypad to set Averages to 5.
7. Adjust the probe until you see a square wave with a perfectly flat top on the display. Figure 3-2 shows where the adjustment is located.

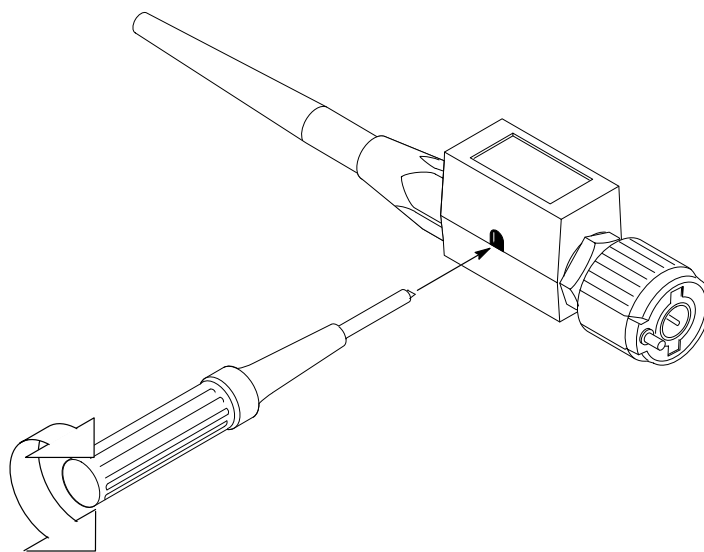

Figure 3-2: P6139A Probe Adjustment

Input Impedance Considerations

To ensure proper coupling of your input signals to the oscilloscope, consider the following points when you use 50 Ω coupling with any channel:

- The oscilloscope does not accurately display frequencies under 200 kHz if AC coupling is selected.
- The oscilloscope reduces the maximum volts/division setting for the channel to 1 V from 10 V (to 10 V from 100 V with a X10 probe attached), since input amplitudes appropriate for the higher settings would overload the 50 Ω input.
- The oscilloscope switches to 50 Ω and disables AC coupling (and switches coupling to DC if AC is selected) if you connect an active probe, such as the P6245 probe. Such probes also reduce the maximum volts/div to 10 V as just described. This behavior results in 50 Ω , nonAC coupling, which is appropriate for such probes.

NOTE. *If you remove an active probe, the oscilloscope does not switch coupling back to 1 M Ω (nor AC if it was previously selected). Nor does it restore a volts/division setting limited due to 50 Ω selection when you restore 1 M Ω coupling. In general, you must set channel scale, input coupling, and impedance appropriate for your input coupling scheme. Be sure to switch to 1 M Ω for any input signal not from a 50 Ω system.*

To Find More Information

To find a procedure for changing the coupling and input impedance settings, see *To Change Vertical Parameters* on page 3–12.

To find a list of available probes, see *Accessory Probes*, on page A–4.

To find a guide for selecting probes for a variety of applications, see *Appendix E: Probe Selection*, on page E-1.

Setting up Automatically: Autoset and Reset

The TDS Oscilloscope can automatically obtain and display a stable waveform of usable size. It can also be reset to its factory default settings. This subsection describes how to execute Autoset and reset, and lists the default settings in effect after an Autoset.

Autoset automatically sets up the front panel controls based on the characteristics of the input signal. It is much faster and easier than a manual control-by-control setup. Autoset adjusts controls in these categories: *Acquisition, Display, Horizontal, Trigger, and Vertical*.

To Autoset the Oscilloscope

Do the following steps to automatically set up the oscilloscope:

1. Press the channel selection button (such as **CH 1**) corresponding to your input channel to make it active.
2. Press **AUTOSET**.

If you use Autoset when one or more channels are displayed, the oscilloscope selects the lowest numbered channel for horizontal scaling and triggering. Vertically, all channels in use are individually scaled. If you use Autoset when no channels are displayed, the oscilloscope will turn on channel one (CH 1) and scale it.

***NOTE.** Autoset may change vertical position in order to position the waveform appropriately. It always sets vertical offset to 0 V.*

List of Autoset Defaults

Table 3–1 lists the autoset defaults.

Table 3–1: Autoset Defaults

Control	Changed by Autoset to
Selected channel	Numerically lowest of the displayed channels
Acquire Mode	Sample
Acquire Repetitive Signal (TDS 700A Models Only)	On
Acquire Stop After	RUN/STOP button only
Display Style	Vectors
Display Intensity — Overall	If less than 50%, set to 75%
Display Format	YT
FastFrame (TDS 700A Models Only)	Off
Horizontal Position	Centered within the graticule window
Horizontal Scale	As determined by the signal frequency
Horizontal Time Base	Main Only
Horizontal Record Length	Unchanged
Horizontal Lock	Unchanged
InstaVu Acquisitions (TDS 700A Models Only)	Unchanged
Limit Test	Off

Table 3–1: Autoset Defaults (Cont.)

Control	Changed by Autoset to
Trigger Position	Unchanged
Trigger Type	Edge
Trigger Source	Numerically lowest of the displayed channels (the selected channel)
Trigger Level	Midpoint of data for the trigger source
Trigger Slope	Positive
Trigger Coupling	DC
Trigger Holdoff	Default Holdoff: Set equal to 5 horizontal divisions Adjustable Holdoff: 250 ns Selection in Mode and Holdoff menu determines whether the default holdoff value or the adjustable hold value is used.
Vertical Scale	As determined by the signal level
Vertical Coupling	DC unless AC was previously set. AC remains unchanged.
Vertical Bandwidth	Full
Vertical Offset	0 volts
Zoom	Off

To Reset the Oscilloscope

Do the following steps to reset the oscilloscope to its factory default settings:

1. Press the Save/Recall **SETUP** button to display the Setup menu (see Figure 3–3). Press the button directly below the **Recall Factory Setup** menu item.
2. Press the button to the right of the **OK Confirm Factory Init** side menu item.
3. Press the **SET LEVEL TO 50%** button (front panel) to be sure the oscilloscope triggers on the input signal.

Selecting Channels

The TDS Oscilloscope applies all actions based on a *specific* waveform, such as taking measurements or applying any changes it receives to the vertical control settings, to the *selected* waveform. You can select a *channel waveform*, a *math waveform*, or a *reference waveform*. This subsection describes how to select a waveform and how you can turn the display of a waveform off.

To Identify the Selected Channel

To determine which channel is currently selected, check the *channel readout*. It shows the selected channel in inverse video in the lower left corner of the display. The *channel reference indicator* for the selected channel also appears in reverse video along the left side of the display. (See Figure 3–3.)

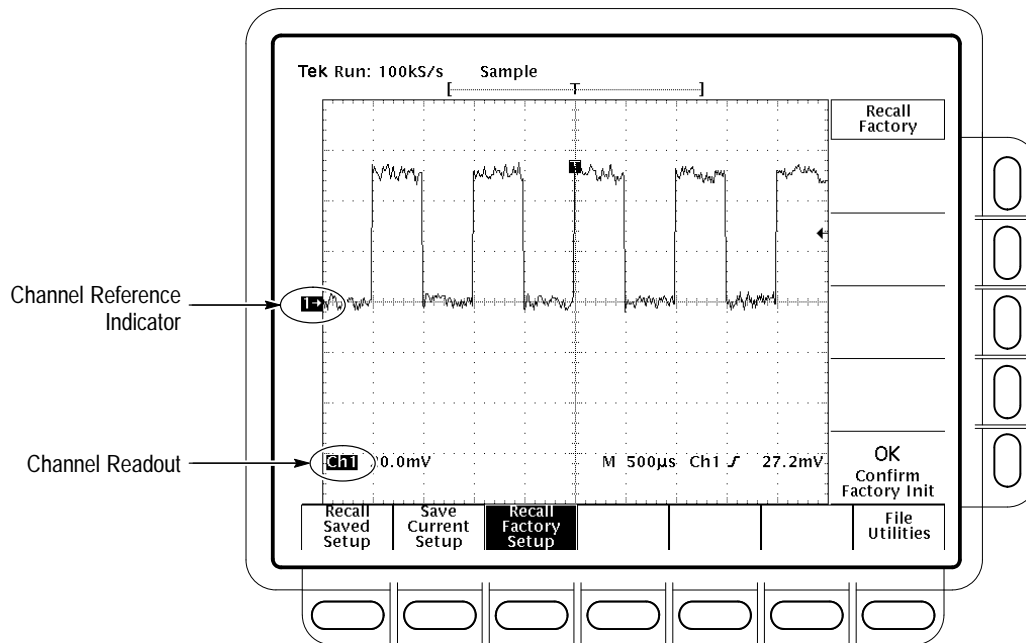

Figure 3–3: The Channel Readout

To Select and Remove Waveforms

To select a channel, use the *channel selection* buttons on the right of the display. These buttons labeled **CH 1**, **CH 2**, **CH 3**, **CH 4**, and **MORE** select a channel and display it if its off. (The **MORE** button allows you to select internally stored *Math* and *Ref* waveforms for display and manipulation.) The selected channel is indicated by the lighting the LED above the button of the selected channel.

Do the following steps to first display and then remove waveforms from the display:

1. Press **CH 1**, **CH 2**, **CH 3**, or **CH 4** to turn on as many of these channels as desired. The one you select last (or first if you only select one) becomes the selected channel. Selecting a channel turns it on if it is not already on.

You do not use the channel selection buttons to select the trigger source. Instead you select the trigger source in the Main Trigger menu or Delayed Trigger menu.

2. Press **WAVEFORM OFF** to turn OFF the display of the selected channel waveform. It will also remove from the display any automated measurements being made on that waveform.

3. To select a math waveform you have created or a reference waveform you have stored, press **MORE** and select the waveform from the More menu. Press **WAVEFORM OFF** while the MORE button is lit to remove the display of the waveform selected in the More menu.

Waveform Priority

When you turn off a waveform, the oscilloscope automatically selects the next highest priority waveform. Figure 3–4 shows the order of priority.

- | | |
|--------|----------|
| 1. CH1 | 1. MATH1 |
| 2. CH2 | 2. MATH2 |
| 3. CH3 | 3. MATH3 |
| 4. CH4 | 4. REF1 |
| | 5. REF2 |
| | 6. REF3 |
| | 7. REF4 |

Figure 3–4: Waveform Selection Priority

Note Figure 3–4 shows two orders of priority due to the following rules: If you are turning off more than one waveform and you start by turning off a channel waveform, all channels will be turned off before going to the MORE waveforms. If you start by turning off the MORE waveforms, all the MORE waveforms will be turned off before going to the channel waveforms.

If you turn off a channel that is a trigger source, it continues to be the trigger source even though the waveform is not displayed.

To Find More Information

To read about selecting reference waveforms, see *Saving and Recalling Waveforms* on page 3–114.

To read about selecting (and creating) math waveforms, see *Waveform Math* on page 3–142.

Scaling and Positioning Waveforms

The TDS Oscilloscope allows you to scale (change the vertical or horizontal size) and position (move up, down, left, or right) waveforms on screen for best display. (Figure 3–5 shows the results of both vertical and horizontal scaling and positioning.) This subsection first tells you how to quickly check and set vertical and horizontal scales, positions, and other parameters, such as vertical bandwidth and horizontal record length.

To Check Position

To quickly see the position of the waveform in the display, check the *Channel Reference* and the *Record View* icons. (See Figure 3–5.)

The Channel Reference icon, at the left side of the display, points to ground on the waveform record when offset is set to 0 V. The oscilloscope contracts or expands the selected waveform around this point when you change the vertical scale.

The Record View, at the top of the display, indicates where the trigger occurs and what part of the waveform record is displayed.

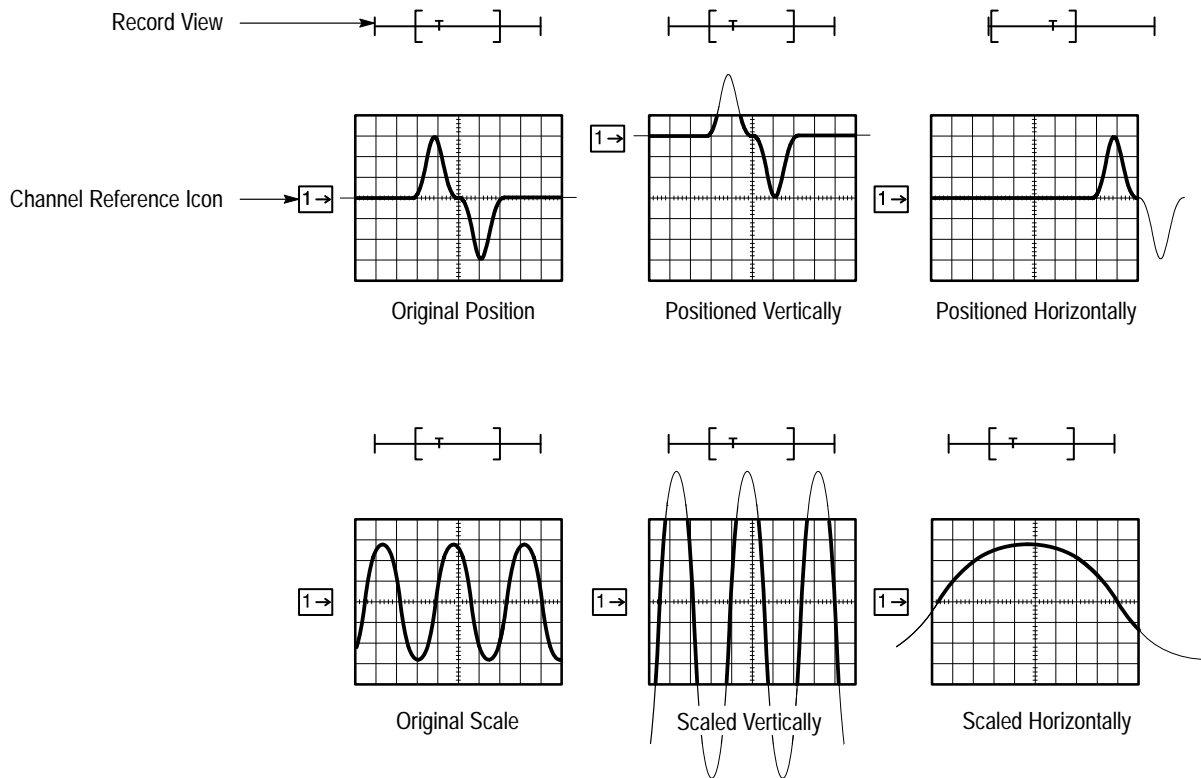

Figure 3-5: Scaling and Positioning

To Check the Vertical Scale

Check the *Vertical Readout* at the bottom-left part of the display to read the volts/division setting for each displayed channel (the selected channel is in inverse video). (See Figure 3-6.)

To Change Vertical Scale and Position

The TDS Oscilloscope permits you to change vertical scale and position quickly from the front panel using dedicated control knobs. To change the vertical scale and position:

1. Turn the vertical **SCALE** knob. Note only the scale of the selected waveform changes.

As you turn the vertical **SCALE** knob clockwise, the value decreases resulting in higher resolution because you see a smaller part of the waveform. As you turn it counterclockwise the scale increases allowing you to see more of the waveform but with lower resolution.

2. Turn the vertical **POSITION** knob. Again, note that only the selected waveform changes position.
3. To make positioning faster, press the **SHIFT** button. When the light above the **SHIFT** button is on and the display says **Coarse Knobs** in the upper right corner, the **POSITION** knob positions waveforms more quickly.

The **POSITION** knob simply adds screen divisions to the reference point of the selected waveform. Adding divisions moves the waveform up and subtracting them moves the waveform down. You also can adjust the waveform position using the offset option in the Vertical menu (discussed later in this section).

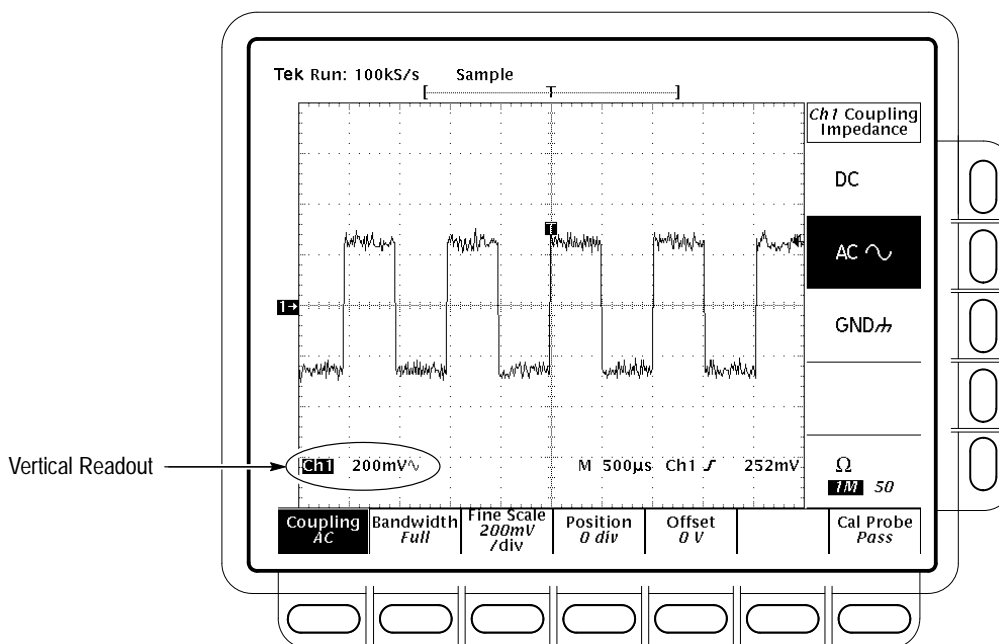

Figure 3-6: Vertical Readouts and Channel Menu



By changing the vertical scale, you can focus on a particular portion of a waveform. By adjusting the vertical position, you can move the waveform up or down on the display. Adjustment of vertical position is particularly useful when you are comparing two or more waveforms.

To Change Vertical Parameters

To select the coupling, bandwidth, and offset for the selected waveform, use the *Vertical menu* (Figure 3–6). This menu also lets you numerically change the position or scale instead of using the vertical knobs. To make such changes, do the following procedures:

Coupling. To choose the type of coupling for attaching the input signal to the vertical attenuator for the selected channel and to set its input impedance:

Press **VERTICAL MENU** → **Coupling** (main) → **DC**, **AC**, **GND**, or Ω (side).

- | | |
|---|--|
| DC | ■ DC coupling shows both the AC and DC components of an input signal. |
| AC  | ■ AC coupling shows only the alternating components of an input signal. |
| GND  | ■ Ground (GND) coupling disconnects the input signal from the acquisition. |
| Ω | ■ Input impedance lets you select either 1 M Ω or 50 Ω impedance. |

NOTE. If you select 50 Ω impedance with AC coupling, the digitizing oscilloscope will not accurately display frequencies under 200 kHz.

Also, when you connect an active probe to the oscilloscope (such as the P6245), the input impedance of the oscilloscope automatically becomes 50 Ω . If you then connect a passive probe (like the P6139A), you need to set the input impedance back to 1 M Ω .

The maximum volts/div setting is reduced from 10 V to 1 V when you select 50 Ω impedance. See the discussion *Input Impedance Considerations on page 3–5*.

Bandwidth. *Bandwidth* refers to the range of frequencies that an oscilloscope can acquire and display accurately (that is, with less than 3 dB attenuation). To select the upper limit for the higher frequency components, change the bandwidth of the selected channel:

Press **VERTICAL MENU** → **Bandwidth** (main) → **Full**, **250 MHz**, or **20 MHz** (side).

Fine Scale. To make fine adjustments to the vertical scale, press **VERTICAL MENU** → **Fine Scale** (main) and use the general purpose knob or the keypad.

Position. To adjust the vertical position to a specific number of divisions, press **VERTICAL MENU** → **Position** (main) and use the general purpose knob or the keypad to set the offset value. Press **Set to 0 divs** (side) if you want to reset the reference point of the selected waveform to the center of the display.

Offset. Use offset to subtract DC bias before examining a waveform. For example, you might want to display a small ripple (for example, 100 mV of ripple) on a power supply output (for example, a +15 V output). Adjust offset to keep the ripple on screen while setting the vertical scale sensitive enough to best display the ripple.

To adjust offset, press **VERTICAL MENU** → **Offset** (main). Then use the general purpose knob or keypad to set the vertical offset. Press **Set to 0 V** (side) if you want to reset the offset to zero.

To Check the Horizontal Status

Check the *Record View* to determine the size and location of the waveform record and the location of the trigger relative to the display. (See Figure 3–7.)

Check the *Time Base readout* at the lower right of the display to see the time/division settings and the time base (main or delayed) being referred to. (See Figure 3–7. Also see Figure 3–5 on page 3–10.) Since all live waveforms use the same time base, the oscilloscope only displays one time base and time/division setting for all the active channels.

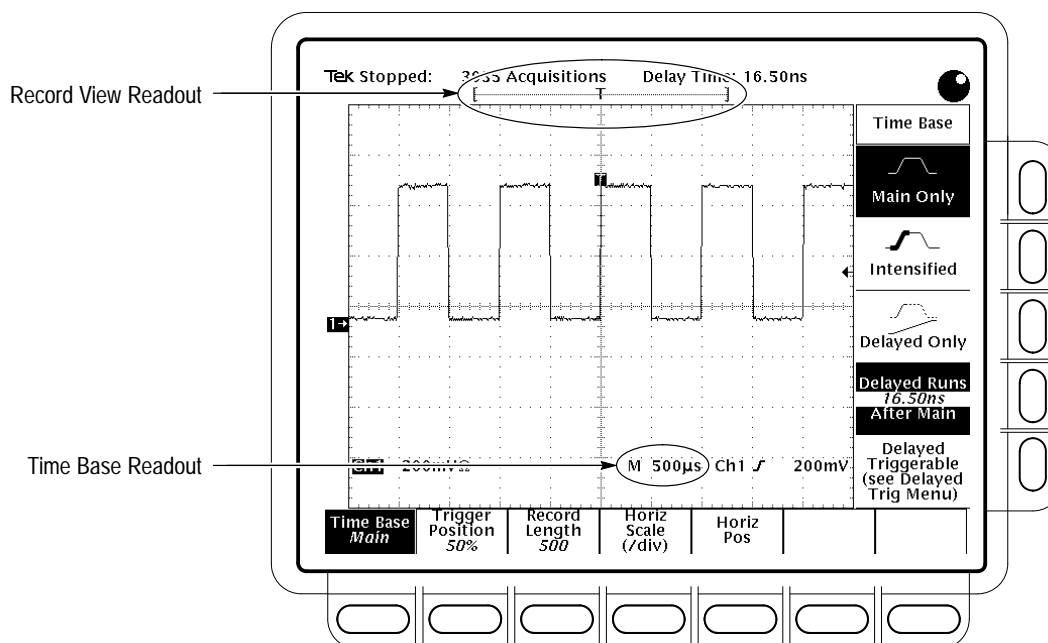

Figure 3–7: Record View and Time Base Readouts

To Change Horizontal Scale and Position

The TDS Oscilloscope provides control of horizontal position and scale using either the horizontal front panel knobs.

By changing the horizontal scale, you can move the waveform right or left to see different portions of the waveform. That is particularly useful when you are using larger record sizes and cannot view the entire waveform on one screen.

To change the horizontal scale and position:

1. Turn the horizontal **POSITION** and horizontal **SCALE** knobs. (See Figure 3–8.)
2. If you want the **POSITION** knob to move faster, press the **SHIFT** button. When the light above the shift button is on and the display says **Coarse Knobs** in the upper right corner, the **POSITION** knob positions waveforms more quickly.

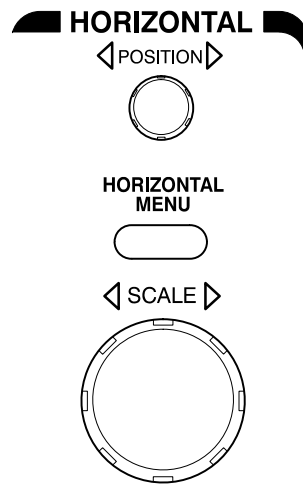

Figure 3–8: Horizontal Controls

When you select a channel, the horizontal **SCALE** knob scales all channel waveforms displayed at the same time. If you select a math or reference waveform, the knob scales only the selected waveform.

When you select a channel, the horizontal **POSITION** knob positions all channel, reference, and math waveforms displayed at the same time *when* Horizontal Lock is set to Lock in the Zoom menu. See *Zoom a Waveform* on page 3–38.

To Change Horizontal Parameters

To select the waveform record length and the trigger position, use the *Horizontal menu*. You can also use this menu to change the horizontal position or scale instead of using the horizontal knobs. You can select the delayed time base (see *Delayed Triggering* on page 3–80) or choose the *frames* on the waveform that you want to see (see *Using FastFrame* on page 3–46).

Trigger Position. The trigger point marks time zero in a waveform record. All record points before the trigger event make up the pretrigger portion of the waveform record. Every record point after the trigger event is part of the

posttrigger portion. All timing measurements in the waveform record are made relative to the trigger event. To define the trigger point position:

Press **HORIZONTAL MENU** → **Trigger Position** (main) → **Set to 10%**, **Set to 50%**, or **Set to 90%** (side), or use the general purpose knob or the keypad to change the value.

Record Length. The number of points that make up the waveform record is defined by the record length. To set the waveform record length:

1. Press **HORIZONTAL MENU** → **Record Length** (main). Select the record length desired from the side menu. Press **–more–** to see additional choices. The available record lengths are as follows:
 - The TDS 684A Oscilloscope provides record lengths of 500, 1000, 2500, 5000, and 15000 points.
 - The TDS 700A Oscilloscopes provide record lengths of 500, 1,000, 2,500, 5,000, 15,000, and 50,000 plus, with option 1M, 75,000, 100,000, 130,000, 250,000, and 500,000. Option 1M is available only at the time of original purchase and is not available for the TDS 684A.

***NOTE.** TDS 700A Models: Hi Res acquisition mode requires twice the acquisition memory of other acquisition modes, therefore, the maximum record length available is 15,000 points for TDS 700A Oscilloscopes without option 1M and 50,000 points with option 1M. Turning Hi Res on switches the setting for record length accordingly, thereby keeping the oscilloscope from running out of memory.*

2. To fit an acquired waveform to the visible screen, regardless of record length, press **HORIZONTAL MENU** → **Record Length** (main). Then toggle **Fit to Screen** to **ON** from the side menu. This feature fits the waveform automatically much like you could do manually — by turning zoom mode on and changing the time/division until the waveform fits the screen. To turn off this feature, toggle **Fit to Screen** to **OFF**.

Horizontal Scale. To change the horizontal scale (time per division) numerically in the menu instead of using the Horizontal **SCALE** knob:

Press **HORIZONTAL MENU** → **Horiz Scale** (main) → **Main Scale** or **Delayed Scale** (side), and use the keypad or the general purpose knob to change the scale values.

Horizontal Position. To set the horizontal position to specific values in the menu instead of using the Horizontal **POSITION** knob:

Press **HORIZONTAL MENU** → **Horiz Pos** (main) → **Set to 10%**, **Set to 50%**, or **Set to 90%** (side) to choose how much of the waveform will be displayed to the left of the display center.

You can also control whether changing the horizontal position setting affects all displayed waveforms, just the live waveforms, or only the selected waveform. See *Zoom a Waveform*, on page 3–38 for the steps to set the horizontal lock feature.

To Select the Delayed Time Base

You also can select Delayed Runs After Main or Delayed Triggerable. Use the main time base for most applications. Use the delayed time base when you want to delay an acquisition so it captures and displays events that follow other events. See *To Find More Information* below.

To Find More Information

To perform tutorials that teach selecting, scaling, and positioning of waveforms, see *Example 1: Displaying a Waveform* on page 2–13 and *Example 2: Displaying Multiple Waveforms* on page 2–15.

To learn how to use delay with waveforms, see *Delayed Triggering* on page 3–80. To learn how to magnify waveforms, see *Zooming on Waveforms*, on page 3–37.

Choosing an Acquisition Mode

The TDS Oscilloscopes are digital products that can acquire and process your input signal in a variety of modes. To help you choose the best mode to use for your signal measurement task, this subsection first describes:

- How the oscilloscope samples and digitizes an input signal
- How the different acquisition modes (such as *interpolation*) affect this process
- How to select among these modes

Following these descriptions are procedures for selecting the sampling and acquisition modes, beginning with *Checking the Acquisition Readout* on page 3–23.

Sampling and Digitizing

Acquisition is the process of sampling the analog input signal, digitizing it to convert it into digital data, and assembling it into a waveform record. (See Figure 3–9.) The oscilloscope creates a digital representation of the input signal by sampling the voltage level of the signal at regular time intervals. The sampled and digitized points are stored in memory along with corresponding timing information. You can use this digital representation of the signal for display, measurements, or further processing.

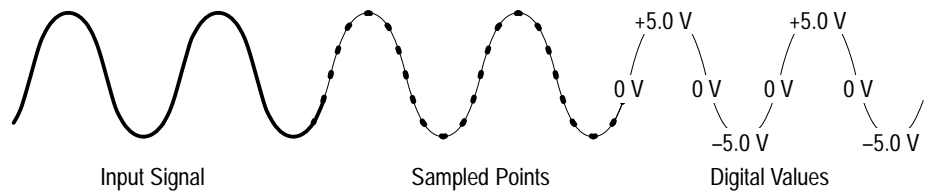

Figure 3-9: Acquisition: Input Analog Signal, Sample, and Digitize

The oscilloscope uses the samples it takes (see Figure 3-11) to create a waveform record containing a user-specified number of data or record points. Each record point represents a certain voltage level that occurs a determined amount of time from the trigger event.

The oscilloscope may take more samples than the number of points in your waveform record. In fact, the oscilloscope may take several samples for each record point (see Figure 3-10). The digitizer can use any extra samples to perform additional processing, such as averaging or looking for minimum and maximum values. The methods of sampling and acquisition modes you choose determine how the oscilloscope assembles the sample points it acquires into the waveform record.

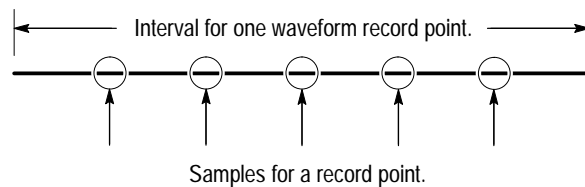

Figure 3-10: Several Points May be Acquired for Each Point Used

Real-time Sampling

The two general methods of sampling are *real-time* and *equivalent-time*. The TDS 684A Oscilloscope uses only real-time sampling; the TDS 700A Oscilloscopes use both real- and equivalent-time sampling.

In real-time sampling, the oscilloscope digitizes all the points it acquires after *one* trigger event (see Figure 3-11). Always use real-time sampling to capture single-shot or transient events.

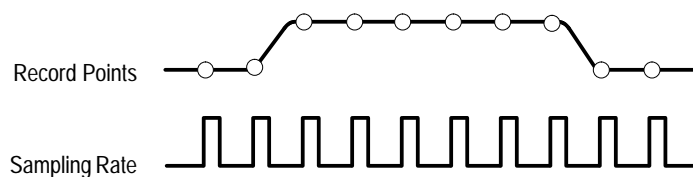

Figure 3-11: Real-Time Sampling

Equivalent-Time Sampling

A TDS 700A model oscilloscope (the TDS 684A uses only real time sampling) uses equivalent time sampling to extend its sample rate over its real-time maximum sampling rate, but only under two conditions:

- You must have turned equivalent-time on in the Acquisition menu.
- You must have set the oscilloscope to a sampling rate that is too fast to allow it to get enough samples with which to create a waveform record using real-time sampling.

If both conditions are the case, the oscilloscope takes a few samples with each trigger event and eventually obtains enough samples to construct a waveform record. In short, the oscilloscope makes *multiple* acquisitions of a *repetitive* waveform to obtain the sample density required for a waveform record. (See Figure 3–12.) By doing so, the oscilloscope lets you accurately acquire signals with frequencies much higher than its maximum real-time bandwidth would allow. Equivalent-time sampling should only be used on repetitive signals.

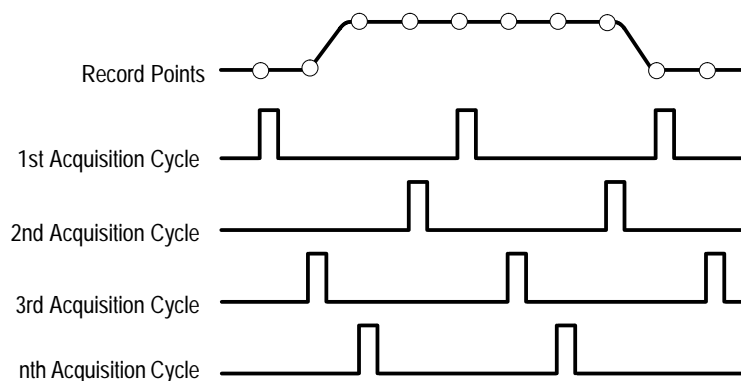

Figure 3–12: Equivalent-Time Sampling

The type of equivalent-time sampling the oscilloscope uses is called *random equivalent-time sampling*. Although it takes the samples sequentially in time, it takes them randomly with respect to the trigger. Random sampling occurs because the oscilloscope sample clock runs asynchronously with respect to the input signal and the signal trigger. The oscilloscope takes samples independently of the trigger position and displays them based on the time difference between the sample and the trigger.

Interpolation

Your oscilloscope can interpolate between the samples it acquires. Like for equivalent time sampling, it does so only when it cannot obtain all the *real* samples it needs to fill up its waveform record. For instance, setting the horizontal SCALE to progressively faster acquisition rates leaves progressively shorter time periods for the waveform record. Therefore, the oscilloscope must sample faster to acquire the samples (record points) needed to fill up the record.

Eventually the time period established by scale setting does not allow enough time to get all the real samples needed to fill the record.

The situation just described occurs if you set the Horizontal SCALE knob to a time base setting that is faster than 10 ns (TDS 684A). (The setting varies with the number of channels for TDS 700A models; see Tables 3–4 and 3–5 beginning on page 3–24.) The oscilloscope then interpolates to create the intervening points in the waveform record. There are two options for interpolation: linear or $\sin(x)/x$. (TDS 700A models can also equivalent time sample to acquire more samples; see *Equivalent-Time Sampling* on page 3–18.)

Linear interpolation computes record points between actual acquired samples by using a straight line fit. It assumes all the interpolated points fall in their appropriate point in time on that straight line. Linear interpolation is useful for many waveforms such as pulse trains.

Sin(x)/x interpolation computes record points using a curve fit between the actual values acquired. It assumes all the interpolated points fall along that curve. That is particularly useful when acquiring more rounded waveforms such as sine waves. Actually, it is appropriate for general use, although it may introduce some overshoot or undershoot in signals with fast rise times.

NOTE. When using either type of interpolation, you may want to set the display style so that the real samples are displayed intensified relative to the interpolated samples. The instructions under Select the Display Style on page 3–28 explain how to turn on intensified samples.

Interleaving

A TDS 700A Oscilloscope can interleave its channels to attain higher digitizing rates without equivalent time sampling or interpolating. The oscilloscope applies the digitizing resources of unused channels (that is, channels that are turned off) to sample those that are in use (turned on). Table 3–2 lists how interleaving more than one digitizer to sample a channel extends the maximum digitizing rate.

Table 3–2: How Interleaving Affects Sample Rate

No. of Channels Turned On	Digitizers Used Per Channel	Maximum Digitizing Rate ¹	
		TDS 744A	TDS 784A
One	Four	2 Gs/second	4 Gs/second
Two	Two	1 Gs/second	2 Gs/second
Three or Four	One	500 Ms/second	1 Gs/second

¹ When real-time sampling. (Gs = Gigasamples; Ms = Megasamples.)

Once you set horizontal scale to exceed the maximum digitizing rate for the number of channels in use (see Table 3–2), the oscilloscope will not be able to get enough samples to create a waveform record. At that point, the oscilloscope will either *interpolate* to calculate additional samples or it will switch from real to equivalent time sampling to obtain additional samples. (See *Interpolation* on page 3–18 and *Equivalent-Time Sampling* on page 3–18.)

The Acquisition Modes

All three TDS Oscilloscopes support the following three acquisition modes: *Sample*, *Envelope*, and *Average*. TDS 700A Oscilloscopes support two additional acquisition modes: *Peak Detect* and *Hi Res*. Keep in mind which modes apply to your model oscilloscope as you read the following descriptions.

Sample (the mode most commonly used), Peak Detect, and Hi Res modes operate in real time on a single trigger event, provided that the oscilloscope can acquire enough samples for each trigger event. Envelope and Average modes operate on multiple acquisitions; the oscilloscope averages or envelopes several waveforms on a point-by-point basis. (For TDS 700A models only, Hi Res, Envelope, and Average modes are not available when in InstaVu mode; see *Incompatible Modes* on page 3–45.)

Figure 3–13 illustrates the different modes and lists the benefits of each. It will help you select the appropriate mode for your application. Refer to it as you read the following descriptions of each mode.



Sample Mode. In Sample mode, the oscilloscope creates a record point by saving the first sample (of perhaps many) during each acquisition interval. (An acquisition interval is the time covered by the waveform record divided by the record length.) Sample mode is the default mode.



Envelope Mode. Envelope mode lets you acquire and display a waveform record that shows the extremes in variation over several acquisitions. You specify the number of acquisitions over which to accumulate the data. The oscilloscope saves the highest and lowest values in two adjacent intervals similar to the Peak Detect mode. But Envelope mode, unlike Peak Detect, gathers peaks over many trigger events.

After each trigger event, the oscilloscope acquires data and then compares the min/max values from the current acquisition with those stored from previous acquisitions. The final display shows the most extreme values for all the acquisitions for each point in the waveform record.



Average Mode. Average mode lets you acquire and display a waveform record that is the averaged result of several acquisitions. This mode reduces random noise. The oscilloscope acquires data after each trigger event using Sample mode. It then averages the record point from the current acquisition with those stored from previous acquisitions.

Single Waveform Acquisition

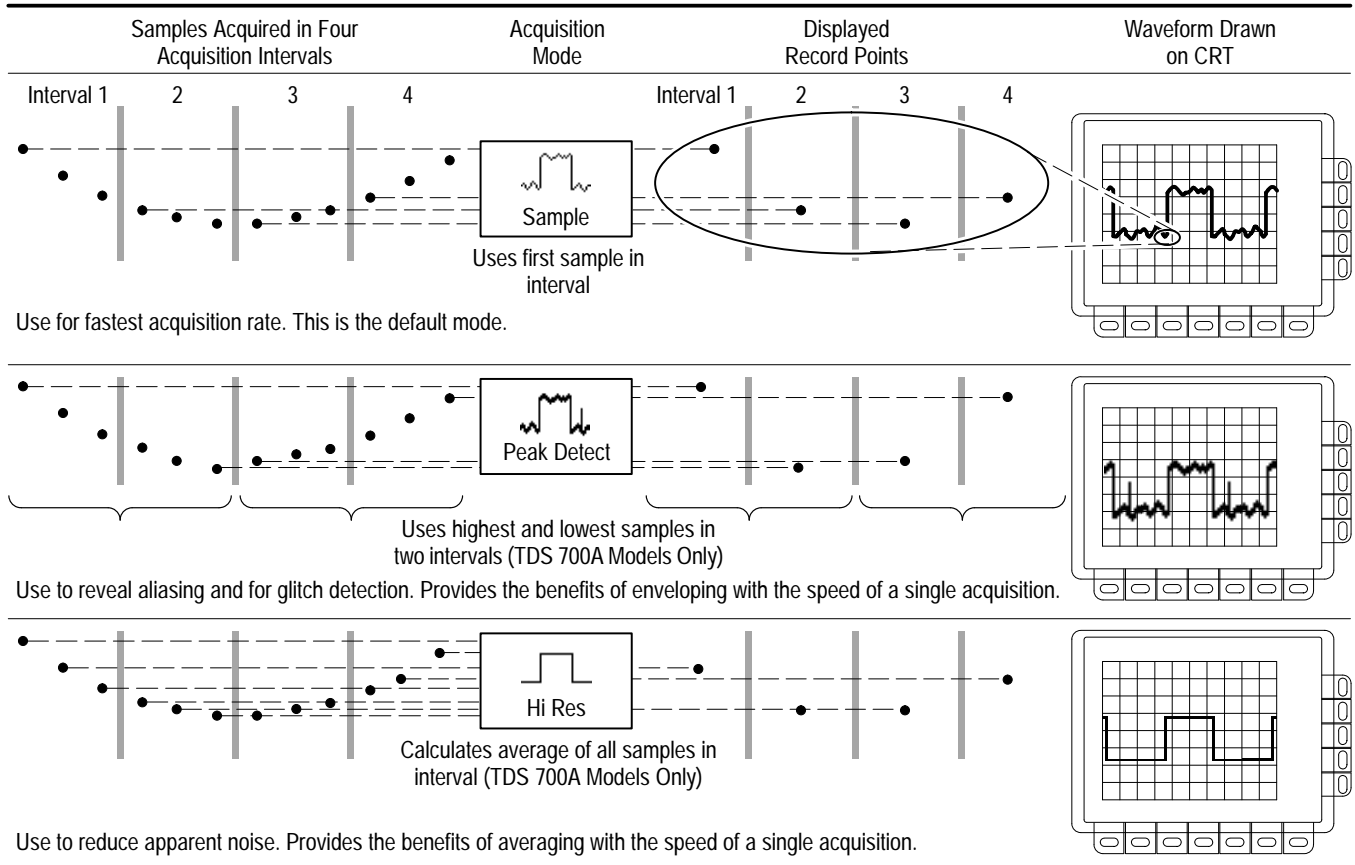

Multiple Waveform Acquisitions

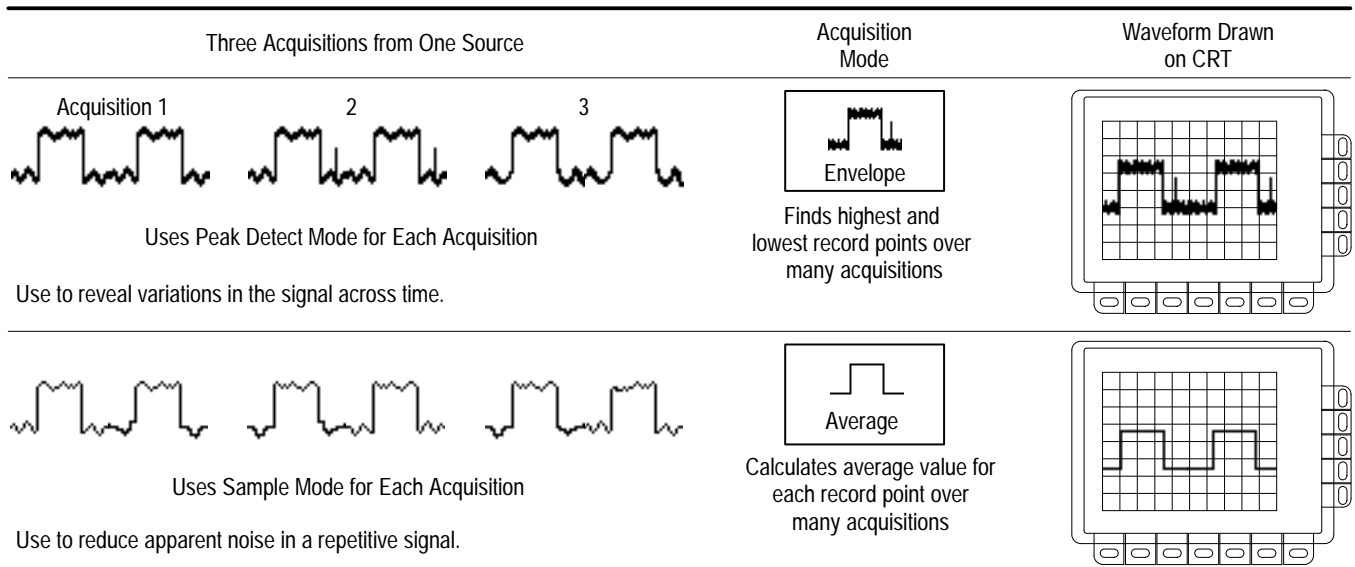

Figure 3-13: How the Acquisition Modes Work



Peak Detect Mode. TDS 700A models only: Peak Detect mode alternates between saving the highest sample in one acquisition interval and lowest sample in the next acquisition interval. Peak Detect mode only works with real-time, noninterpolated sampling.

If you set the time base so fast that it requires real-time interpolation or equivalent-time sampling, the mode automatically changes from Peak Detect to Sample, although the menu selection will not change.



Hi Res Mode. TDS 700A models only: Hi Res mode averages all samples taken during an acquisition interval to create a record point. The average results in a higher-resolution, lower-bandwidth waveform.

A key advantage of Hi Res is its potential for increasing resolution regardless of the input signal. Table 3–3 and the equations shown below illustrate how you can obtain up to 15 significant bits with Hi res mode. Note that the resolution improvements are limited to speeds slower than 100 ns/div. Also, resolutions above 15 bits are not allowed by internal hardware and computation limitations.

$$S_i = \text{Sampling Interval for TDS 744A} = 1 \text{ ns}$$

$$\Delta t = \text{Sample Interval} = \frac{\text{Time/Div}}{\text{Number Of Points/Div}} = \frac{5 \mu\text{s/Div}}{50 \text{ Points/Div}} = 100 \text{ ns}$$

$$N_d = \text{Number of points per decimation interval} = \frac{\Delta t}{S_i} = 100$$

$$\text{Resolution Enhancement (bits)} = 0.5 \times \text{LOG}_2(N_d) \approx 3 \text{ extra bits}$$

$$\text{Bits of Resolution} = \text{Resolution Enhancement (3 bits)} + 8 \text{ bits} \approx 11 \text{ bits}$$

Hi Res mode only works with real-time, noninterpolated sampling. If you set the time base so fast that it requires real-time interpolation or equivalent-time sampling, the mode automatically becomes Sample even though the menu selection will not change.

Table 3–3: Additional Resolution Bits

Time Base Speed	Bits of Resolution
100 ns and faster	8 bits
200 ns to 500 ns	9 bits
1 μs to 2 μs	10 bits
5 μs to 10 μs	11 bits
20 μs to 50 μs	12 bits
100 μs to 200 μs	13 bits
500 μs	14 bits
1 ms and slower	15 bits

Checking the Acquisition Readout

To determine the acquisition sampling rate, the acquisition state (running or stopped), and the acquisition mode, check the Acquisition readout at the top of the display. (See Figure 3–14.) The state “Run:” shows the sample rate and acquisition mode. The state “Stop:” shows the number of acquisitions acquired since the last stop or major change.

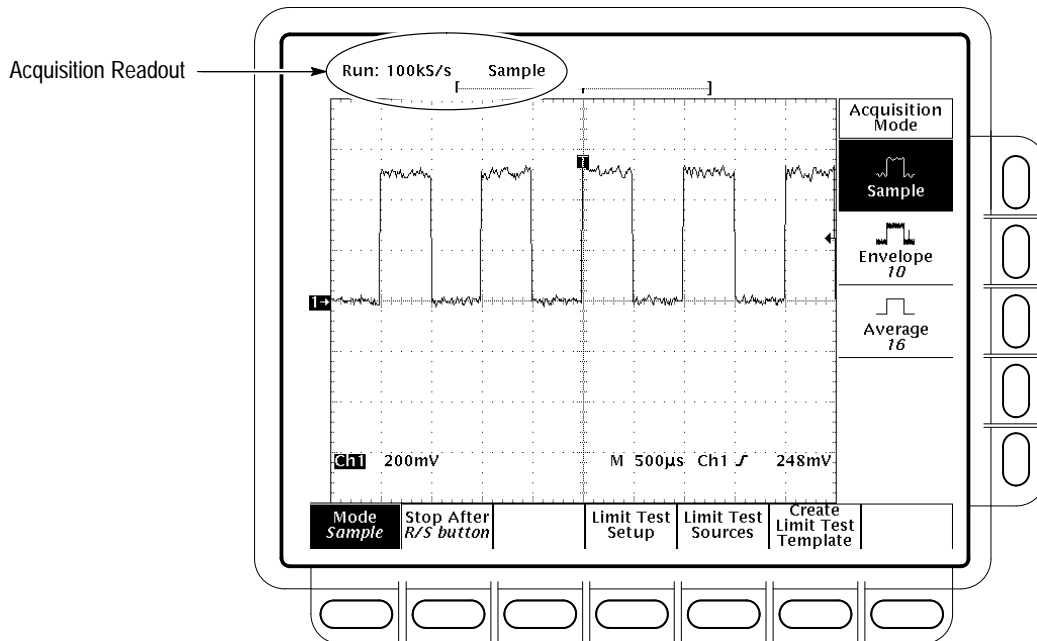

Figure 3–14: Acquisition Menu and Readout

Selecting an Acquisition Mode

The oscilloscope provides several modes (see *The Acquisition Modes* on page 3–20) for acquiring and converting analog data into digital form. To choose how the oscilloscope will create points in the waveform record:

1. Press **SHIFT ACQUIRE MENU** → **Mode** (main). (See Figure 3–14.)
2. TDS 684A: Press **Sample**, **Envelope**, or **Average** (side) or ...

TDS 700A Models: Press **Sample**, **Peak Detect**, **Hi Res**, **Envelope**, or **Average** (side). (InstaVu mode must be off to use Hi Res, Envelope, or Average modes.)

3. If you selected Envelope or Average, enter the number of waveform records to be enveloped or averaged using the keypad or the general purpose knob.

NOTE. TDS 700A models only: Selecting Hi Res mode in the Acquire menu will automatically reduce the record length to a value that prevents overflow of acquisition memory. Because Hi Res mode uses twice the acquisition memory that the other acquisition modes use, allowing selection of the longer horizontal record lengths with Hi Res mode would cause the oscilloscope to run out of memory.

Selecting Repetitive Sampling

TDS 700A models only: To limit the oscilloscope to real-time sampling or let it choose between real-time or equivalent-time sampling:

Press **SHIFT ACQUIRE MENU** → **Repetitive Signal** (main) → **ON** or **OFF** (side).

- **ON (Enable ET)** uses both the real-time and the equivalent-time sampling as appropriate.
- **OFF (Real Time Only)** limits the oscilloscope to real-time sampling. If the oscilloscope cannot accurately get enough samples for a complete waveform, it will interpolate.

The sampling speeds and the number of channels you choose affect the mode the oscilloscope uses to sample waveforms. If the time base is set slow enough, the oscilloscope always uses real-time sampling; if set fast enough, it always uses equivalent-time sampling or interpolation. For speeds in between, the oscilloscope creates waveform records differently depending on the number of input channels turned on. See Table 3–4 for the TDS 744A or Table 3–5 for the TDS 784A.

Table 3–4: TDS 744A Sampling Mode Selection (When Fit to Screen is Off)

Time Base ¹	One Channel	Two Channels	Three or Four Channels
> 50 ns	Real-time	Real-time	Real-time
50 ns	Real-time	Real-time	Equiv.-time or interpolate
25 ns	Real-time	Equiv.-time or interpolate	Equiv.-time or interpolate
< 25 ns	Equiv.-time or Interpolate	Equiv.-time or Interpolate	Equiv.-time or Interpolate

¹ ">" means "slower than"; "<" means "faster than."

Table 3-5: TDS 784A Sampling Mode Selection (When Fit to Screen is Off)

Time Base ¹	One Channel	Two Channels	Three or Four Channels
> 25 ns	Real-time	Real-time	Real-time
25 ns	Real-time	Real-time	Equiv.-time or interpolate
12.5 ns	Real-time	Equiv.-time or interpolate	Equiv.-time or interpolate
< 12.5 ns	Equiv.-time or Interpolate	Equiv.-time or Interpolate	Equiv.-time or Interpolate

¹ ">" means "slower than"; "<" means "faster than."

NOTE. The oscilloscope will use the interpolation method selected in the display menu to fill in the missing record points — either linear or $\sin(x)/x$ interpolation. See Interpolation on page 3-18 for a discussion of interpolation.

Stop After To choose the event that signals the oscilloscope to stop acquiring waveforms, do the following step:

Press **SHIFT ACQUIRE MENU** → **Stop After** (main) → **RUN/STOP button only**, **Single Acquisition Sequence**, or **Limit Test Condition Met** (side). (See Figure 3-15.) (TDS 700A models only: single acquisition and limit testing are ignored in InstaVu mode; see *Incompatible Modes* on page 3-45.)

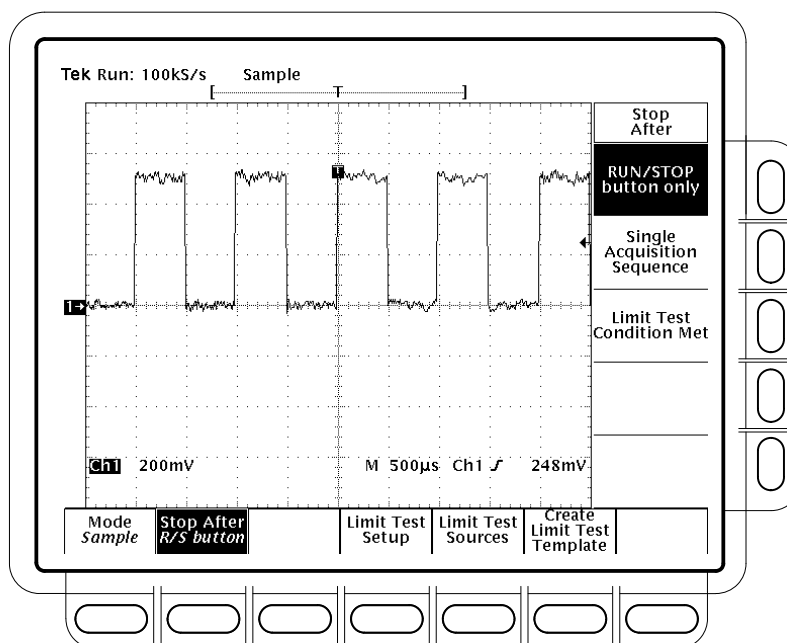

Figure 3-15: Acquire Menu — Stop After

- Press **RUN/STOP button only** (side) to use the **RUN/STOP** button to start or stop acquiring. Pressing the RUN/STOP button once will stop the acquisitions. The upper left hand corner in the display will say “Stop” and show the number of acquisitions. If you press the button again, the oscilloscope will resume taking acquisitions.
- Press **Single Acquisition Sequence** (side). That selection lets you run a single sequence of acquisitions by pressing the **RUN/STOP** button. In Sample, Peak Detect, or Hi Res mode, the oscilloscope will acquire a waveform record with the first valid trigger event and stop. (Peak Detect and Hi Res are only available on TDS 700A models.)

In Envelope or Average mode, the oscilloscope will make the specified number of acquisitions to complete the averaging or enveloping task.

TDS 700A models only: If the oscilloscope is in equivalent-time mode and you press **Single Acquisition Sequence** (side), it will continue to recognize trigger events and acquire samples until the waveform record is filled.

***NOTE.** To quickly select Single Acquisition Sequence without displaying the Acquire and Stop After menus, press SHIFT FORCE TRIG. Now the RUN/STOP button operates as just described. (You still must display the Acquire menu and then the Stop After menu to leave Single Acquisition Sequence operation.)*

- Press **Limit Test Condition Met** (side) to acquire waveforms until waveform data exceeds the limits specified in the limit test. Then acquisition stops. At that point, you can also specify other actions for the oscilloscope to take, using the selections available in the Limit Test Setup main menu.

***NOTE.** In order for the oscilloscope to stop an acquisition when limit test conditions have been met, limit testing must be turned ON using the Limit Test Setup main menu.*

Setting up limit testing requires several more steps. See *Limit Testing*, on page 3–137.

Preventing Aliasing

Under certain conditions, a waveform may be aliased on screen. Read the following description about aliasing and the suggestions for preventing it.

About Aliasing. When a waveform aliases, it appears on screen with a frequency lower than the actual waveform being input or it appears unstable even though the light next to **TRIG'D** is lighted. Aliasing occurs because the oscilloscope cannot sample the signal fast enough to construct an accurate waveform record. (See Figure 3–16.)

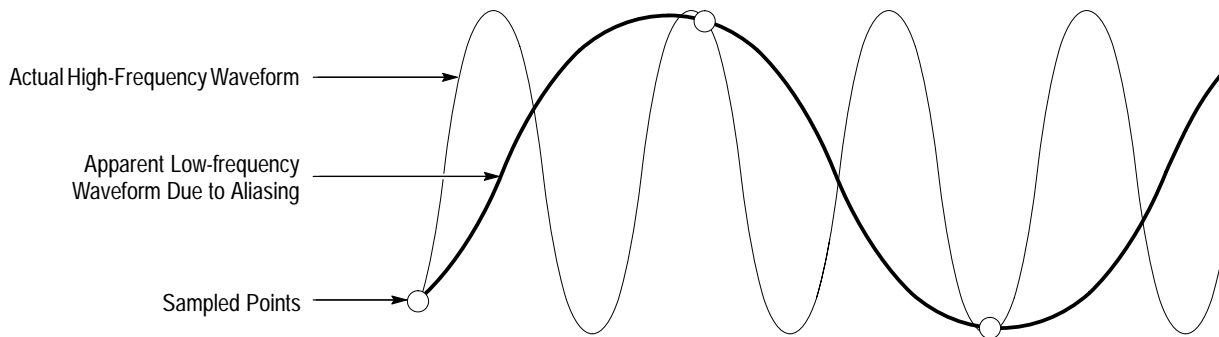

Figure 3–16: Aliasing

Methods to Check and Eliminate. To quickly check for aliasing, slowly increase the horizontal scale (time per division setting). If the shape of the displayed waveform changes drastically or becomes stable at a faster time base setting, your waveform was probably aliased.

To avoid aliasing, be sure to sample the input signal at a rate more than twice as fast as the highest frequency component. For example, a signal with frequency components of 500 MHz would need to be sampled at a rate faster than 1 Gigasamples/second to represent it accurately and avoid to aliasing. The following tips may help you eliminate aliasing on a signal:

- Try adjusting the horizontal scale.
- Try pressing the **AUTOSET** button.
- Try switching the acquisition mode (in the acquisition menu) to Envelope (all three TDS models) or Peak Detect (TDS 700A models only). Envelope searches for samples with the highest and lowest values over multiple acquisitions; Peak Detect mode does the same but in a single acquisition. Either can detect faster signal components over time.
- Try pressing the **InstaVu** acquisition button. (TDS 700A models only). InstaVu mode results in waveform displays similar to those obtained using analog oscilloscope, due to its fast waveform capture rate.

Customizing the Display

The TDS Oscilloscope can display waveform records and other display elements in different ways. This subsection describes how to adjust the oscilloscope display style, intensity level, graticule, and format.

NOTE. TDS 700A models only: This subsection assumes you are using Normal acquisitions mode and gives display settings for this mode. If you select InstaVu acquisitions, procedures for making Style, Format, and Readout display settings differ and some selections are not permitted. See Using InstaVu[™] Acquisition Mode, on page 3–43, for setup differences and Incompatible Modes on page 3–45.

Change Display Settings

To bring up the Display menu:

Press **DISPLAY** → **Settings** (main) → **Display** (pop-up).

The **Display** menu allows you to adjust the style, intensity level, graticule, and format features described below. The **Color** menu allows you to alter color settings for various display components such as waveforms and text. To find more information on color, see *Customizing the Display Color* on page 3–33.

Select the Display Style

TDS 684A only: Press **DISPLAY** → **Style** (main) → **Vectors, Intensified Samples, Dots, Infinite Persistence**, or **Variable Persistence** (side) (See Figure 3–17.)

TDS 700A models only: Press **DISPLAY** → **Mode** (main) → **Normal** (pop-up) → **Style** (main) → **Vectors, Intensified Samples, Dots, Infinite Persistence**, or **Variable Persistence** (side)

Vectors style displays vectors (lines) between the record points.

Dots style displays waveform record points as dots.

Intensified Samples style also displays waveform record points as dots. However, the points actually sampled are displayed in the color labeled “Zone” in the Display Colors menus.

In addition to choosing Intensified Samples in the side menu, the oscilloscope must be interpolating (equivalent time must be off for TDS 700A models) or Zoom must be on with its horizontal expansion greater than 1X. See *Interpolation* on page 3–18; see *Zooming on Waveforms* on page 3–37.

Variable Persistence style accumulates the record points on screen and displays them only for a specific time interval. In that mode, the display behaves like that of an analog oscilloscope. You enter the time for that option with the keypad or the general purpose knob. Record points are also displayed with colors that vary depending on the persistence of the point. See *Choose a Palette* on page 3–33.

Infinite Persistence style accumulates the record points until you change some control (such as scale factor) causing the display to be erased.

NOTE. TDS 700A models only: See Using InstaVu™ Acquisition Mode, on page 3–43, for differences in how Style setup differs for InstaVu mode.

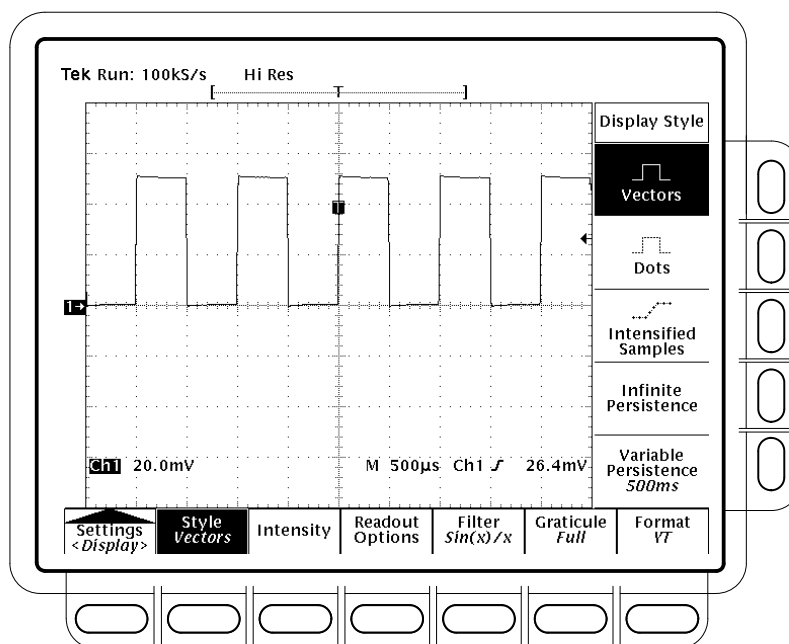

Figure 3–17: Display Menu — Style

Adjust Intensity

Intensity lets you set text/graticule and waveform intensity (brightness) levels. To set the intensity:

Press **DISPLAY** → **Intensity** (main) → **Text/Grat** or **Waveform** (side). Enter the intensity percentage values with the keypad or the general purpose knob.

All intensity adjustments operate over a range from 20% (close to fully off) to 100% (fully bright).

Set Display Readout Options

Readout options control whether the trigger indicator, trigger level bar, and current date and time appear on the display. The options also control what style trigger level bar, long or short, is displayed.

1. TDS 684A: Press **DISPLAY** → **Readout Options** (main).

TDS 700A Models: Press **DISPLAY** → **Mode** (main) → **Normal** (pop-up) → **Format/RO** (main).

2. Toggle **Display 'T' @ Trigger Point** (side) to select whether or not to display 'T' indicating the trigger point. You can select **ON** or **OFF**. (The trigger point indicates the position of the trigger in the waveform record.)
3. Press **Trigger Bar Style** (side) to select either the short or the long trigger bar or to turn the trigger bar off. (See Figure 3–18. Note that both styles are shown for illustrating purposes, but you can only display one style at a time.)

The trigger bar is only displayed if the trigger source is an active, displayed waveform. Also, two trigger bars are displayed when delay triggerable acquisitions are displayed — one for the main and one for the delayed timebase. The trigger bar is a visual indicator of the trigger level.

Sometimes, especially when using the hardcopy feature, you may want to display the current date and time on screen. (To find more information displaying and setting date and time, see *Date/Time Stamp the Hardcopy* on page 3–123.)

4. Press **Display Date/Time** (side) to turn it on or off. Push **Clear Menu** to see the current date and time.

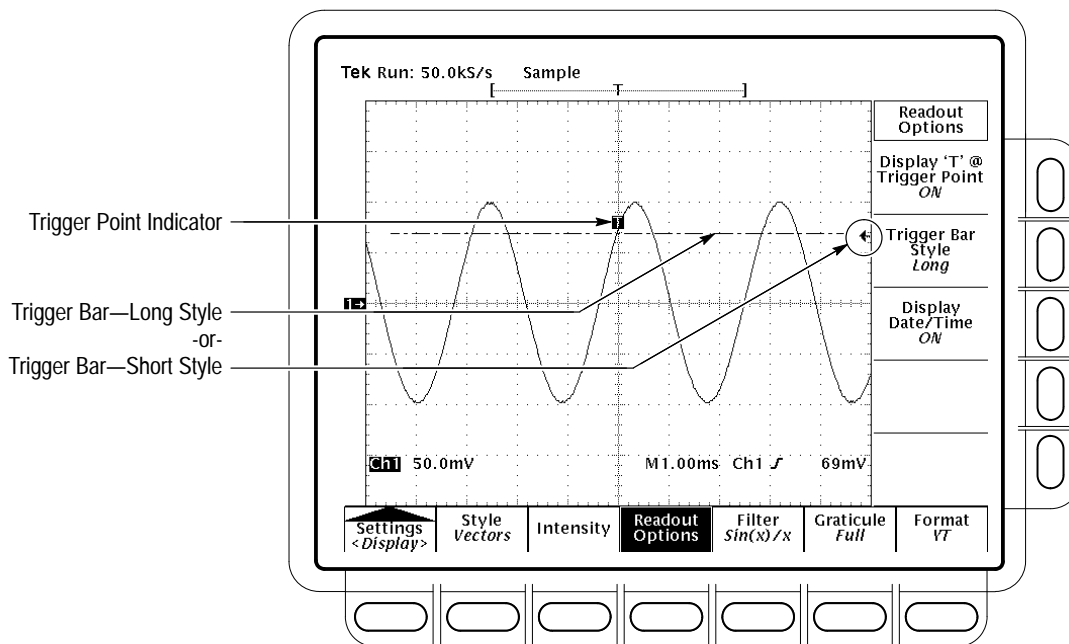

Figure 3–18: Trigger Point and Level Indicators

Select Interpolation Filter

The display filter types are $\sin(x)/x$ interpolation and linear interpolation. To switch between interpolation filters:

Press **DISPLAY** → **Filter** (main) → **Sin(x)/x Interpolation** or **Linear Interpolation** (side).

NOTE. When the horizontal scale is set to the faster rates (10 ns/div for the TDS 684A; see Tables 3–4 and 3–5 beginning on page 3–24 for rates specific to the two TDS 700A models) or when using the ZOOM feature to expand waveforms horizontally, interpolation occurs. (The filter type, linear or $\sin(x)/x$, depends on which is set in the Display menu.) Otherwise, interpolation is not used. See Interpolation on page 3–18 for a discussion of interpolation.

Select the Graticule Type

To change the graticule:

Press **DISPLAY** → **Graticule** (main) → **Full, Grid, Cross Hair, Frame, NTSC** or **PAL** (side).



Full provides a grid, cross hairs and a frame.



Grid displays a frame and a grid.



Cross Hair provides cross hairs, and a frame.



Frame displays just a frame.

NTSC provides a grid useful for measuring NTSC-class waveforms.

PAL provides a grid useful for measuring PAL-class waveforms.

NOTE. Selecting either *NTSC* or *PAL* graticules automatically changes the vertical scale, position settings, coupling, and sets to zero any vertical offset of any channel displayed. These settings are not restored after switching to other graticule types. Therefore, you might want to recall the factory setup or other stored setup after selecting a different graticule.

Select the Format

The oscilloscope displays waveforms in either of two formats: YT and XY. To set the display axis format:

TDS 684A: Press **DISPLAY** → **Format** (main) → **XY** or **YT** (side).

TDS 700A models: Press **DISPLAY** → **Mode** (main) → **Normal** (pop-up) → **Format/RO** (main) → **XY** or **YT** (side).



YT is the conventional oscilloscope display format. It shows a signal voltage (the vertical axis) as it varies over time (the horizontal axis).



XY format compares the voltage levels of two waveform records point by point. That is, the oscilloscope displays a graph of the voltage of one waveform record against the voltage of another waveform record. This mode is particularly useful for studying phase relationships.

When you choose the *XY* format, any channel or reference displayed is assigned to the axis indicated in Table 3–6 and displayed as part of an *XY* pair. If only one source in an *XY* pair is displayed, the oscilloscope automatically turns on the other source to complete the *XY* pair when you select *XY*. Moreover, once *XY* is on, selecting either source in a pair turns the pair on; pressing **WAVEFORM OFF** for either source in the pair removes both sources from the display.

Table 3–6: *XY* Format Pairs

XY Pair	X-Axis Source	Y-Axis Source
Ch 1 and Ch 2	Ch 1	Ch 2
Ch 3 and Ch 4	Ch 3	Ch 4
Ref 1 and Ref 2	Ref 1	Ref 2
Ref 3 and Ref 4	Ref 3	Ref 4

Since selecting *YT* or *XY* affects only the display, the horizontal and vertical scale and position knobs and menus control the same parameters regardless of the mode selected. Specifically, in *XY* mode, the horizontal scale will continue to control the time base and the horizontal position will continue to control which portion of the waveforms are displayed.

XY format is a dot-only display, although it can have persistence. The Vector style selection has no effect when you select *XY* format.

You cannot display Math waveforms in *XY* format. They will disappear from the display when you select *XY*.

NOTE. Use of *XY* at higher room temperatures or with higher intensity display formats, such as the white fields in the Hardcopy palette, can temporarily degrade display quality.

Customizing the Display Color

The TDS Oscilloscope can display information in different colors. This subsection describes how to use the Color menu to choose the colors in which the various display objects appear.

Change the Display Color

To bring up the Color menu:

1. Press **DISPLAY** to show the Display menu.
2. Press **Settings** in the main menu until you select **Color** from the pop-up menu. (See Figure 3–19.)

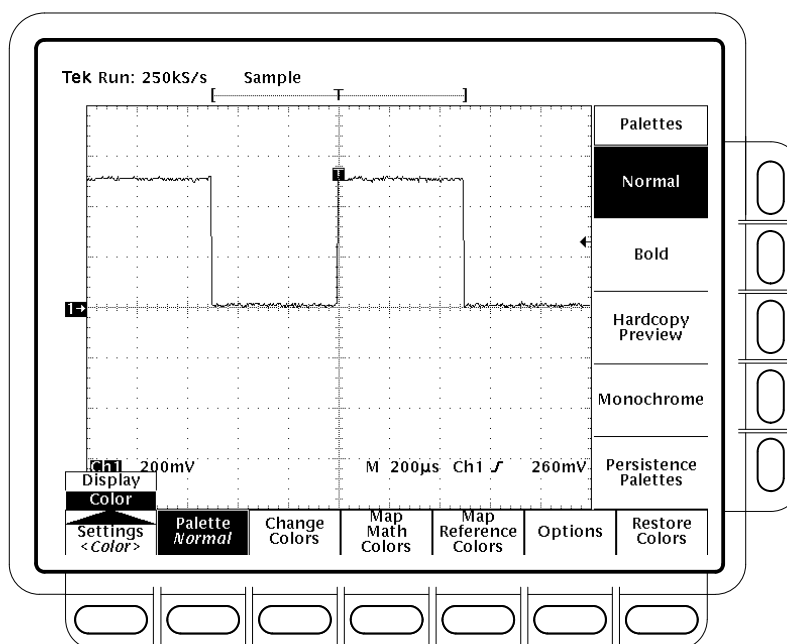

Figure 3–19: Display Menu — Setting

The Color menu allows you to alter color settings for various display components such as waveforms and text. The Display menu allows you to adjust the style, intensity level, graticule, and format features. To find more information on display, see *Change the Display Settings* on page 3–28.

Choose a Palette

To choose a palette of 13 colors from a menu of preset palettes:

1. Choose the starting palette by selecting **Palette** from the main menu.

2. Select one of the available palettes in the side menu. Choose from **Normal**, **Bold**, **Hardcopy Preview** or **Monochrome**.
3. If you are using a persistence display and want to vary the color of each point depending on its persistence, choose **Persistence Palettes**. Then choose **Temperature**, **Spectral**, or **Gray Scale** from the resulting side menu. Choose **View Palette** to preview your selection on the display. Press **Persistence Palette** to quit preview mode. Press **Clear Menu** to return to the Palette menu.

***NOTE.** Use at higher room temperatures or with higher intensity display formats, such as the white fields in the Hardcopy Preview palette, can temporarily degrade display quality.*

You can select the Hardcopy Preview palette when using certain color hardcopy formats. The default colors in the this palette comprise a white background and fully saturated primary colors which generally produce the best result.

Change the Palette Colors

To change the color of the current palette, select a color and vary these attributes:

Hue, which is the wavelength of light reflected from the surface. It varies continuously along the color spectrum as produced by a rainbow.

Lightness, which is the amount of light reflected from the surface. It varies from black, to the nominal color, to white.

Saturation, which is the intensity of color. Completely desaturated color is gray. Completely saturated color of any hue is that color at its most intense level.

1. Select the main menu **Change Colors** item. (See Figure 3–20.)
2. Select one of the 13 colors by pressing (repeatedly) **Color** in the side menu.
3. If you want to use the factory default for this color, press the side menu **Reset to Factory Color**.
4. Choose **Hue** from the side menu and use the general purpose knob or keypad to select the desired hue. Values range from 0 to 359. Sample values are: 0 = blue, 60 = magenta, 120 = red, 180 = yellow, 240 = green, and 300 = cyan.
5. Choose **Lightness** from the side menu and use the general purpose knob or keypad to select the lightness you desire. A value of 0 results in black. A value of 50 provides the nominal color. A value of 100 results in white.

- Choose **Saturation** from the side menu and use the general purpose knob or keypad to select the saturation you desire. A value of 100 provides a pure color. A value of 0 provides gray.

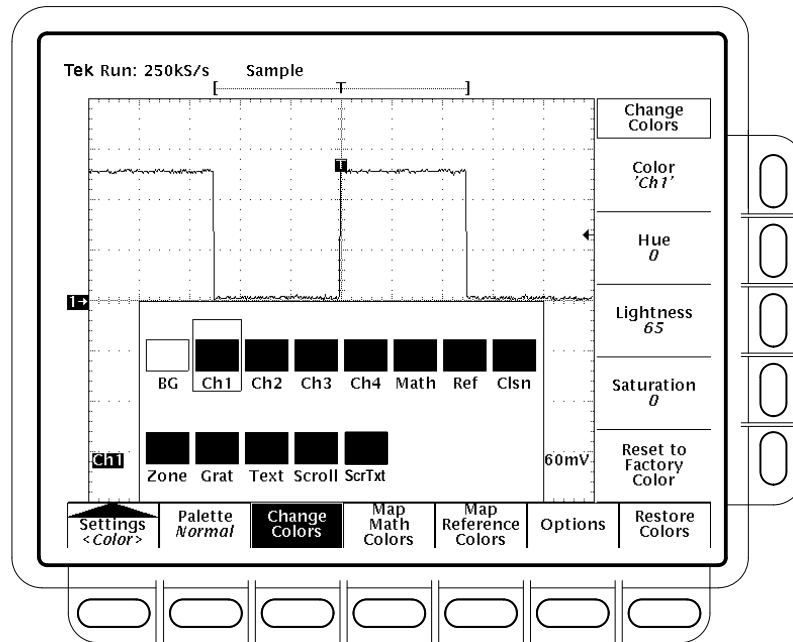

Figure 3-20: Display Menu — Palette Colors

Set Math Waveform Color

To define math waveform colors:

- Choose to define math waveform colors by selecting the main menu **Map Math** item.
- Select one of the three math waveforms by pressing **Math** in the side menu.
- If you want to assign the selected math waveform to a specific color, press **Color** and cycle through the choices.
- If you want the selected math waveform to be the same color as the waveform it is based on, select **Color Matches Contents**. If the math waveform is based on dual waveforms, the math waveform will use the color of the first constituent waveform.

To return to the factory defaults, select **Reset to Factory Color**.

Set Reference Waveform Color

To define reference waveform colors:

- Press **Map Reference** in the main menu. (See Figure 3-21.)

2. Select one of the four reference waveforms by pressing **Ref** in the side menu.
3. To assign the selected reference waveform to a specific color, press (repeatedly) **Color** and choose the value.
4. To make the selected reference waveform the same color as the waveform it is based on, select **Color Matches Contents**.

To return to the factory defaults, select **Reset to Factory Color**.

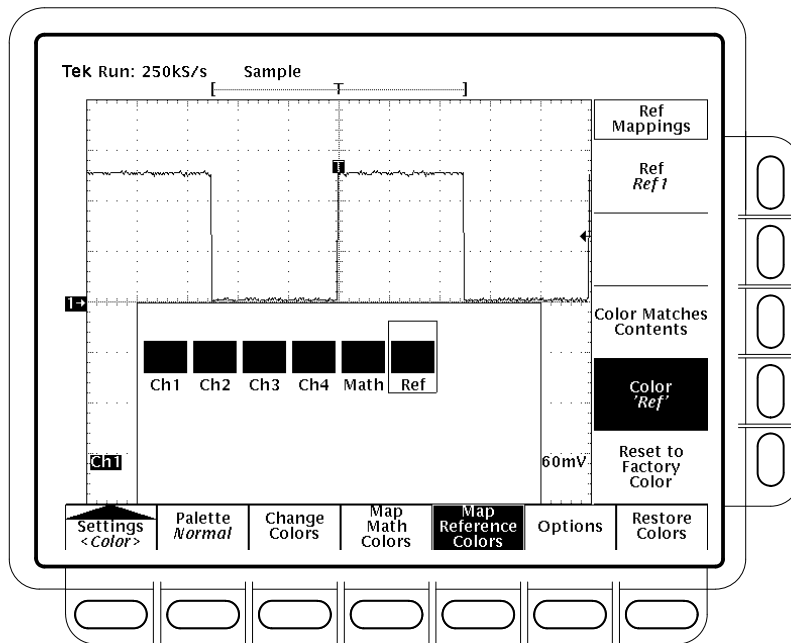

Figure 3-21: Display Menu — Map Reference Colors

Select Options

To define what color to show where a waveform crosses another waveform:

1. Press the **Options** main menu item.
2. Toggle **Collision Contrast** to **ON** in the side menu to mark collision zones with a special color.

Restore Colors

To restore colors to their factory default settings:

1. Press the main menu **Restore Colors** item. (See Figure 3-22.)
2. Select the object(s) you want to restore by pressing **Reset Current Palette To Factory**, **Reset All Palettes To Factory** or **Reset All Mappings To Factory** in the side menu.

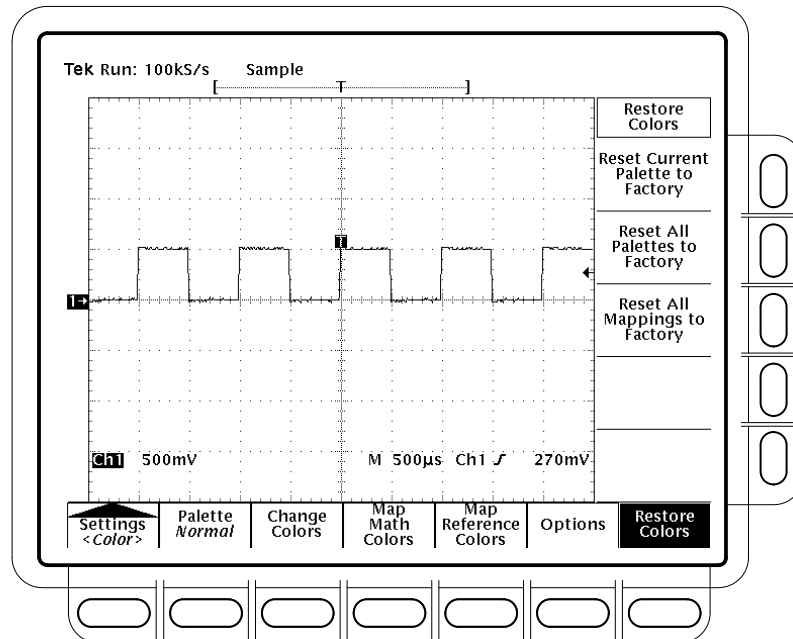

Figure 3-22: Display Menu — Restore Colors

Zooming on Waveforms

The TDS Oscilloscope can expand or compress (zoom in or out) on a waveform without changing the acquisition parameters (sample rate, record length, and so on). This subsection describes how to use Zoom and how it interacts with the selected waveform. It also describes how interpolation can affect Zoom.

Use Zoom (press the ZOOM button) when you want to temporarily expand a waveform to inspect small feature(s) on that waveform. For example, to temporarily expand the front corner of a pulse to inspect its aberrations, use Zoom to expand it horizontally and vertically. After you are finished, you can return to your original horizontal scale setting by pressing one menu button. (Zoom is also handy if you have acquired a waveform at the fastest time per division and want to further expand the waveform horizontally.)

Using with Waveforms

To help you use zoom effectively, consider how it operates on waveforms. When zooming vertically, the oscilloscope expands or contracts the *selected* waveform only. Also, the oscilloscope only positions the selected waveform when in Zoom.

When zooming horizontally, Zoom expands either the selected waveform, all live waveforms, or all live and reference waveforms, depending on the setting for Horizontal Lock in the Zoom menu.

When zooming horizontally or vertically, Zoom expands or contracts the waveform by the zoom factor in 1X, 2X, and 5X steps.

Interpolation and Zoom

To help you use Zoom effectively, consider how it is affected by interpolation. When you zoom on a waveform, you expand a portion of it. If the expansion requires the oscilloscope to show more points for that portion than it has acquired, it interpolates.

The method the oscilloscope uses to interpolate, linear or $\sin(x)/x$, can affect the way Zoom displays your waveform. If you selected $\sin(x)/x$ (the default), it may introduce some overshoot or undershoot to the waveform edges. If such is the case, change the interpolation method to linear, following the instructions on page 3–40.

To read about the two interpolation methods, see *Interpolation* on page 3–18. To differentiate between the real and interpolated samples, set the display style to **Intensified Samples**. (See *Select the Display Style* on page 3–28.)

Checking the Zoom Factor

To quickly determine the zoom factor of a zoomed waveform, select it and check the Zoom readout. It shows the selected waveform by number, along with the horizontal and vertical expansion factors.

The Zoom readout appears at the top of the display when zoom is on. (See Figure 3–23 on page 3–39.) The TDS 700A models do not display the Zoom readout when in dual-window (preview) mode.

Zoom a Waveform

To use Zoom, select a waveform, turn Zoom on, and magnify that waveform using the vertical and horizontal scale knobs:

1. Press any of waveform selection buttons **CH 1** through **CH 4** on the right side of the display. Or press **MORE** and select a math or reference waveform from the More menu.
2. Press **ZOOM**.
3. TDS 684A only: Press **ON** (side) in the Zoom menu. The **ZOOM** front-panel button should light up.

TDS 700A models only: Press **ZOOM** → **Mode** (main) → **ON** (side). The **ZOOM** front-panel button should light up. Toggle **Dual Zoom** to **OFF** in the side menu.

4. Adjust the vertical zoom factor for the selected waveform using the vertical **SCALE** knob. Adjust the vertical position of the zoomed waveform using the vertical **POSITION** knob.

- Adjust the horizontal zoom factor using the horizontal **SCALE** knob. Adjust the horizontal position of the zoomed waveform using the horizontal **POSITION** knob.

Depending on the selection for Horizontal Lock in the side menu, Zoom affects the displayed waveforms as follows:

None — only the waveform currently selected can be magnified and positioned horizontally (Figure 3–23).

Live — all “live” (as opposed to reference) waveforms can be magnified and positioned horizontally at the same time. If a *reference* or *math* waveform is selected and Horizontal Lock set to Live, only the selected reference or math waveform is magnified and positioned.

All — all waveforms displayed (live, math, and reference) can be magnified and positioned horizontally at the same time.

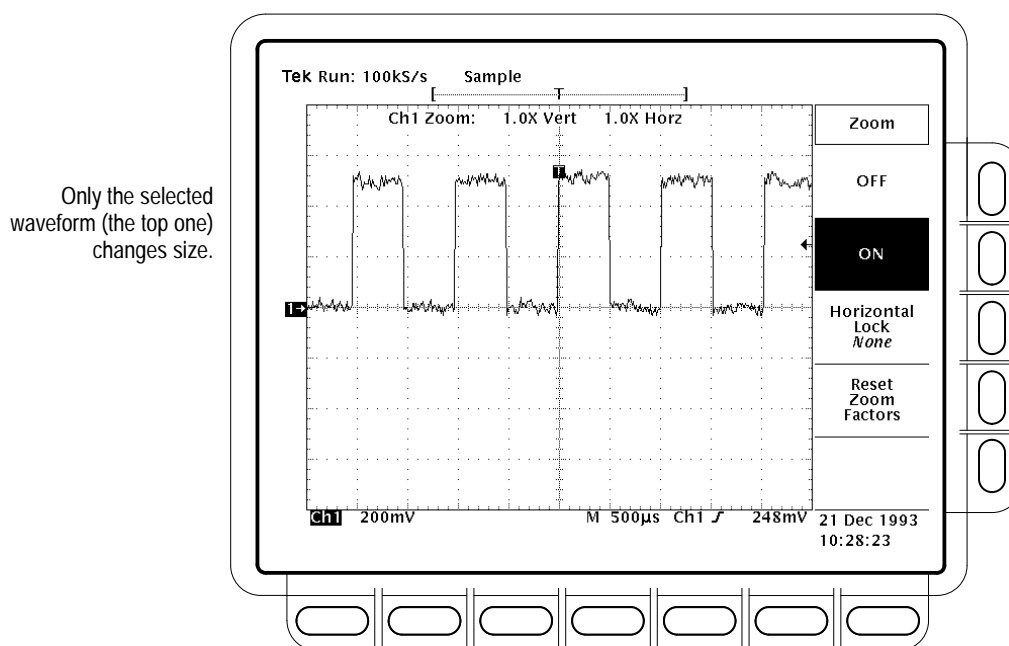

Figure 3–23: Zoom Mode with Horizontal Lock Set to None

- TDS 684A only: Press **Horizontal Lock** (side) to choose which waveforms to zoom horizontally. Repeatedly press **Horizontal Lock** (side) to cycle through the three choices.

TDS 700A models only: Press **ZOOM** → **Lock** (main) → **All**, **Live**, or **None** (side).

NOTE. Although Zoom must be turned on to control which waveforms Zoom affects, the setting for Horizontal Lock affects which waveforms the horizontal control positions whether Zoom is on or off. The rules for the three settings are listed in step 5 on page 3–39.

Set Interpolation To change the interpolation method used, press **DISPLAY** → **Settings** (main) → **Display** (pop-up) → **Filter** (main) → **Sin(x)/x Interpolation** or **Linear Interpolation** (side).

Reset Zoom To reset all zoom factors to their defaults, do the following step:

TDS 684A only: Press **ZOOM** → **Reset Zoom Factors** (side). Press **ZOOM** → **Off** (side) to return to normal oscilloscope (not zoom) operation.

TDS 700A models only: Press **ZOOM** → **Reset** (main) → **Reset Live Factors** or **Reset All Factors** (side). Reset Live Factors resets only for live waveforms, as opposed to reference waveforms; Reset All Factors resets for all waveforms.

Using Dual Window Mode (TDS 700A Models Only) A TDS 700A Series oscilloscope can display and control a waveform that is both zoomed and unzoomed (magnified and unmagnified). To do so, it creates two 1/2 height graticules, or windows, and displays the magnified waveform in the upper, and the unmagnified waveform in the lower graticule. To use Dual Window Zoom (also called zoom preview mode), do the following steps:

1. Press **Zoom** → **Mode** (main) → **Preview** (side). Note that the oscilloscope displays the box-enclosed area on the waveform as magnified in the top graticule. (See Figure 3–24.)
2. To scale or position the *unmagnified* waveform, press **Selected Graticule** (main) → **Lower** (side). Use the vertical and horizontal knobs to scale and position the unmagnified waveform in the box.

Note that as you scale or move the unmagnified waveform relative to the box, the oscilloscope alters the magnified display accordingly to include only the waveform portion within the box.

3. To scale or position the *magnified* waveform, press **Selected Graticule** (main) → **Upper** (side). Use the vertical and horizontal knobs to scale and position the magnified waveform.

Note that as you scale or move the magnified waveform, the oscilloscope scales or moves the box relative to the unmagnified waveform, so the box encloses only the waveform portion magnified in the upper graticule.

In Dual Window Zoom mode, the oscilloscope does not display the zoom magnification factors; however, it does display the scale factors (volts/division and time/division) for the zoomed waveform.

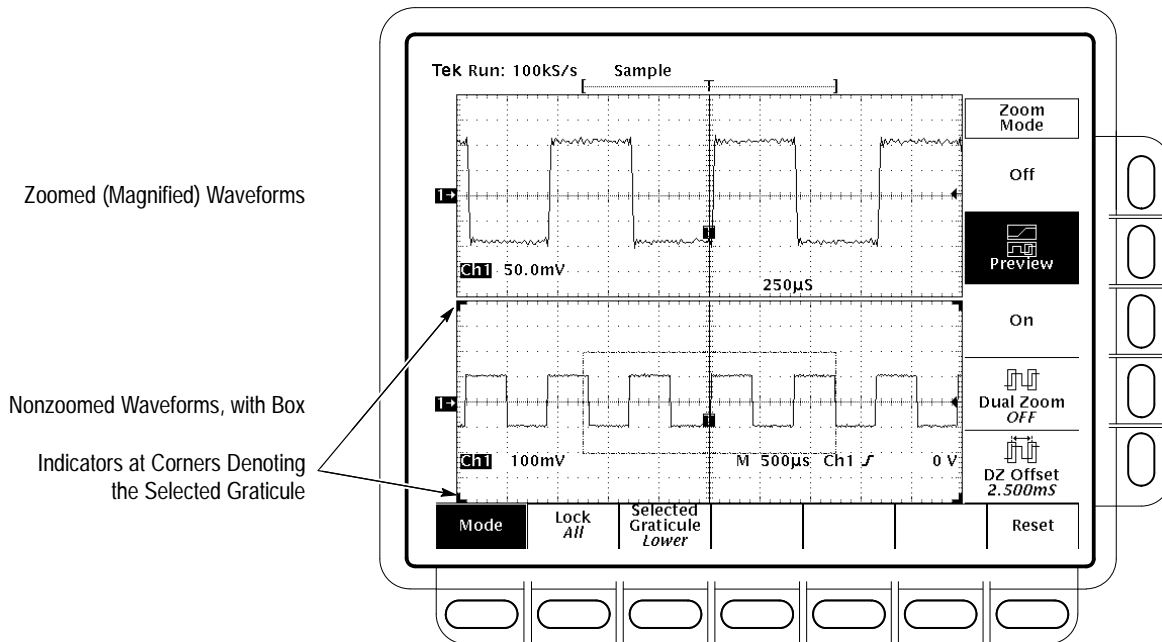

Figure 3-24: Dual Window (Preview) Mode

Dual Zoom a Waveform (TDS 700A Models Only)

To select Dual Zoom, press **ZOOM** → **Mode** (main) → **Dual Zoom** (side) to toggle it to **ON**. (See Figure 3-25.)

Dual zoom displays a second zoomed view of the selected unzoomed waveform. The second zoomed view is offset in time from the first zoomed view. Also, zoom must be enabled (side menu set to On or Preview) to see the Dual Zoom displays.

To Set Dual Zoom Offset

To set the offset in time of the second zoomed waveform from the first, press **ZOOM** → **Mode** (main) → **Dual Zoom Offset** (side). Then turn the general purpose knob or use the keypad to set the offset.

Dual Zoom offset is always positive. The oscilloscope sets the offset as close to the requested value as possible. An offset request of 0.0 insures that the zoom boxes are butted up against each other, regardless of the zoom factor.

The horizontal zoom and scale factors determine the minimum offset time available. Both zoom boxes always enclose equal amounts of time with the second box always offset from the first by a time equal to one box. Doubling the

zoom factor halves the time enclosed by either box and, therefore, halves the minimum offset time.

The oscilloscope retains any value input that is less than the minimum time available as a “request” if you enter that value using the keypad. Increasing the zoom factor or decreasing the horizontal scale to a setting that allows the requested value sets offset time to that value. You cannot set offset to less than the minimum offset time available when using the general purpose knob.

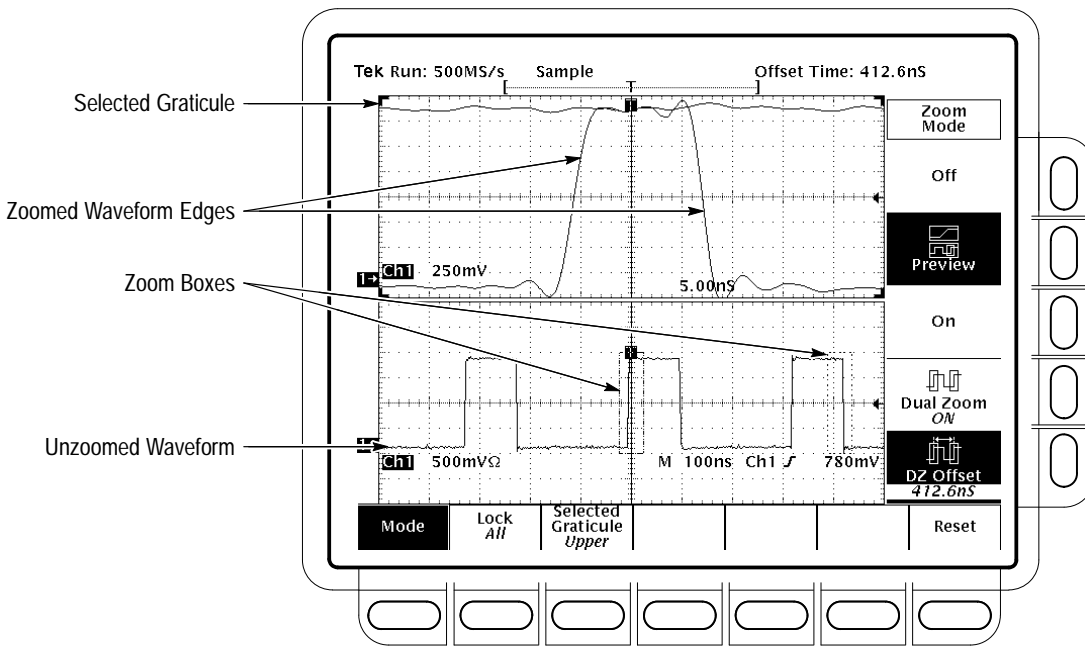

Figure 3–25: Dual Zoom — Shown Dual Window (Preview) Mode

NOTE. To make setting up Dual Zoom easier, turn on Preview in the side menu. In this dual-window mode, the zoomed display appears in the top graticule, while the lower graticule shows the two zoomed portions enclosed in two boxes on the unzoomed waveform. Adjusting offset moves the right box relative to the left box, which remains stationary. The associated zoomed waveform in the upper graticule moves to track the offset changes. You can also adjust the waveform relative to the zoom boxes by selecting the lower graticule and adjusting the vertical and horizontal control knobs. See Using Dual Window Mode on page 3–40.

Using InstaVu™ Acquisition Mode (TDS 700A Models Only)

The TDS 744A and TDS 784A Oscilloscopes can use InstaVu acquisition mode to reduce the dead time between waveform updates that normally occur when digitizing storage oscilloscopes (DSOs) acquire waveforms. InstaVu mode can capture and display transient deviations, such as glitches or runt pulses, often missed during longer dead times that accompany normal DSO display. This subsection describes how to use InstaVu mode and how it differs from normal acquisition mode.

Waveform Capture Rate

Figure 3–26 illustrates how InstaVu acquisition mode differs from the normal acquisition mode used by digital storage oscilloscopes. Note that normal mode follows a “capture waveform–digitize waveform–update waveform memory–display waveform” cycle. Normal mode misses short term deviations occurring during the long dead times. Typical waveform capture rates are 50 waveforms per second.

InstaVu mode increases the waveform capture rate to up to 400,000 waveforms per second, updating the waveform array many times between displays. This very fast frame rate greatly increases the probability that runts, glitches, and other short term changes will accumulate in waveform memory. The oscilloscope then displays the waveform at the normal display rate using variable or infinite persistence. You can control how long the waveform persists on screen by selecting variable persistence and setting a decay constant.

To Use InstaVu Mode

To turn on InstaVu mode, do *either* of the two following steps:

1. Press the front-panel button **InstaVu**. (See Figure 3–27.)
2. Press **DISPLAY → Mode** (main). Push **Mode** again to toggle to InstaVu mode. (See Figure 3–27.)

To turn InstaVu off, press **InstaVu**. Alternatively, press **DISPLAY → Mode** (main), and then press **Mode** again to toggle to Normal mode.

Normal DSO Mode

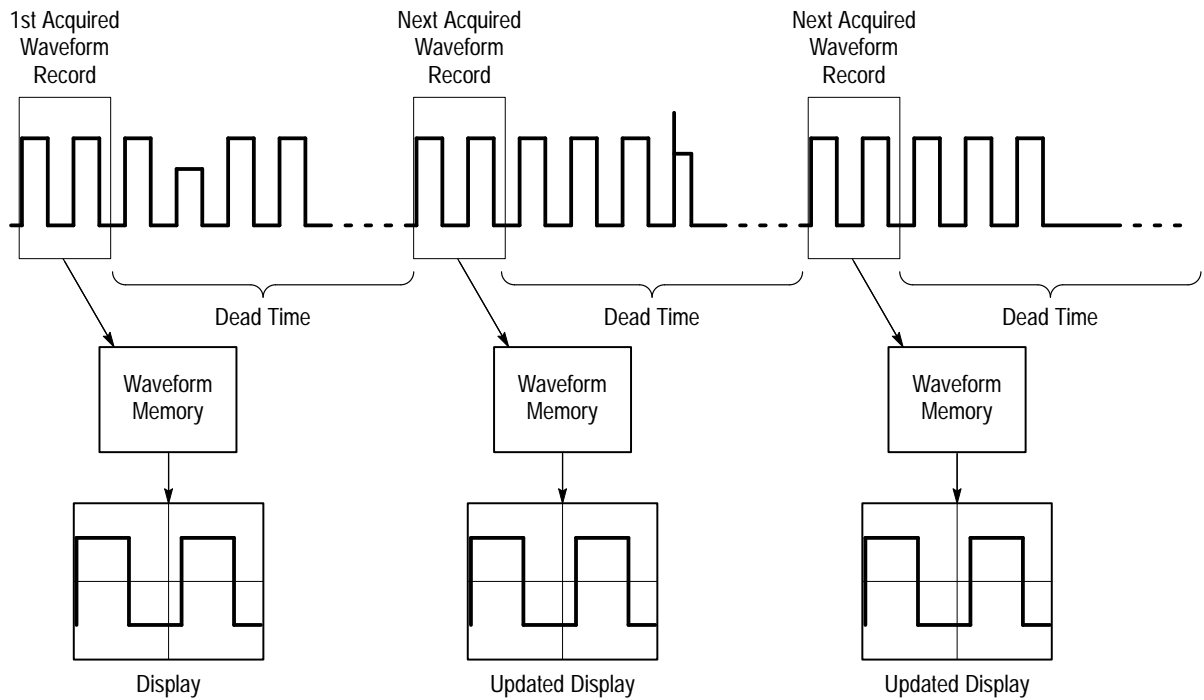

InstaVu Mode

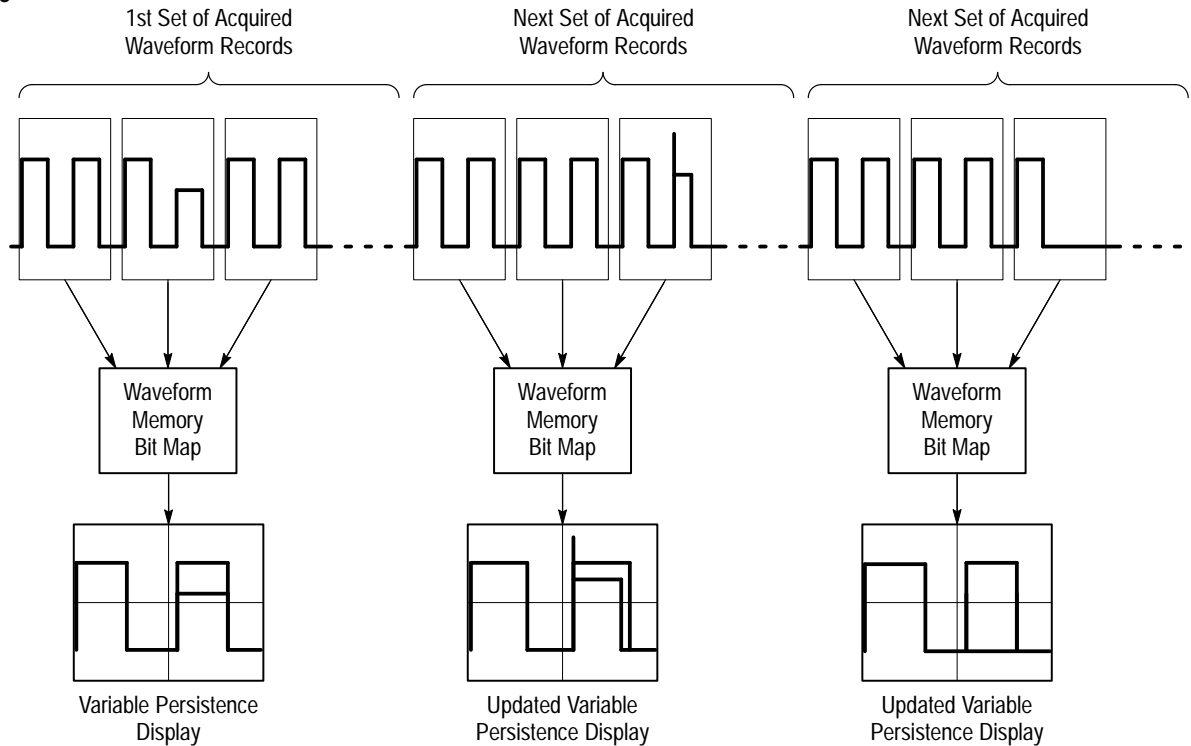

Figure 3–26: Normal DSO Acquisition and Display Mode Versus InstaVu Mode

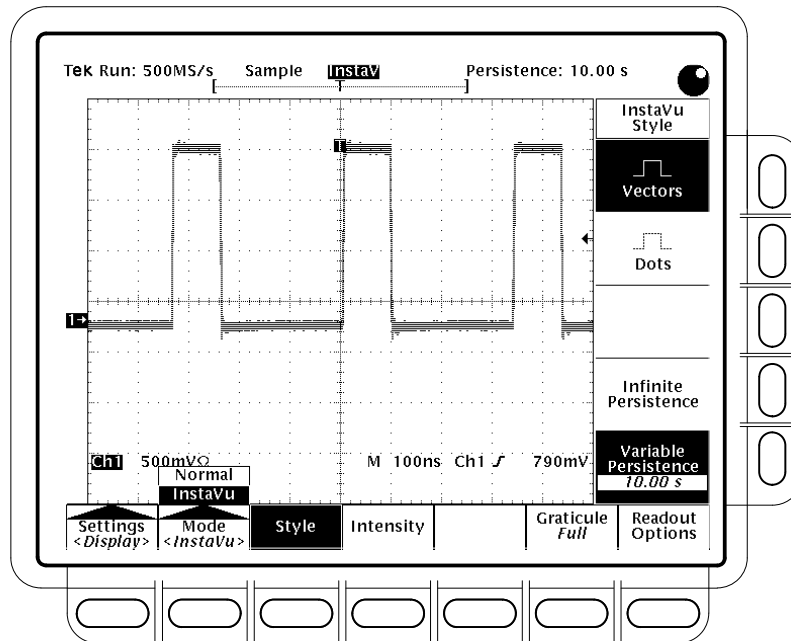

Figure 3-27: InstaVu Display

To Set the InstaVu Style

To change the InstaVu display style, do the following steps:

1. Press **DISPLAY** → **Mode** (main) → **InstaVu** (pop-up) → **Style** (main).
2. Select between **Vectors** and **Dots** in the side menu. (Dots display is the factory default setting.)
3. Select between **Infinite Persistence** and **Variable Persistence** in the side menu. (Variable Persistence is the factory default setting.)
4. Use the general purpose knob or keypad to adjust the persistence time (decay rate) if you have selected **Variable Persistence**.

To Set the InstaVu Readout Options

To change the InstaVu readout options, do the following steps:

1. Press **DISPLAY** → **Mode** (main) → **InstaVu** (pop-up) → **Readout Options** (main).
2. Toggle **Display T Trigger Point**, **Trigger Bar Style** and **Display Date/Time** in the side menu to the settings desired.

Incompatible Modes

Several modes/features are unavailable when InstaVu mode is selected:

- Auto trigger, FastFrame, Limit Testing, XY display, and Zoom modes

- Envelope, Average, Hi Res, and Single Acquisition Sequence acquisition modes and Autosave mode
- Delayed time base
- Record lengths longer than 500 samples
- Interpolation (equivalent time sampling is used instead)
- Vectors when in equivalent time mode (waveforms are displayed as Dots instead). (To determine under what conditions the oscilloscope normally interpolates or uses equivalent time, see *Selecting Repetitive Sampling* on page 3–24.)

If you select any of these modes before or while InstaVu is on, they will remain selected in their respective menus, but the oscilloscope will ignore them. It will put the modes into effect when you turn InstaVu off. If the oscilloscope setup is not as you expect it when you turn InstaVu off, it may be because it quit ignoring these InstaVu incompatible modes.

InstaVu mode disallows selection of Math waveforms. If you attempt to select a math waveform from the MORE menu, the oscilloscope will display an error message. Either switch InstaVu off and create the math waveform, or select a channel waveform and continue using InstaVu mode.

Using FastFrame™ (TDS 700A Models Only)

You can define and enable FastFrame (also called segmented memory). This feature lets you capture multiple acquisitions in the acquisition memory of a single channel. Figure 3–28 shows how FastFrame combines the desired captured records into one larger record. For example, FastFrame would let you store 10 records of 500 samples each into one record with a 5000 sample length.

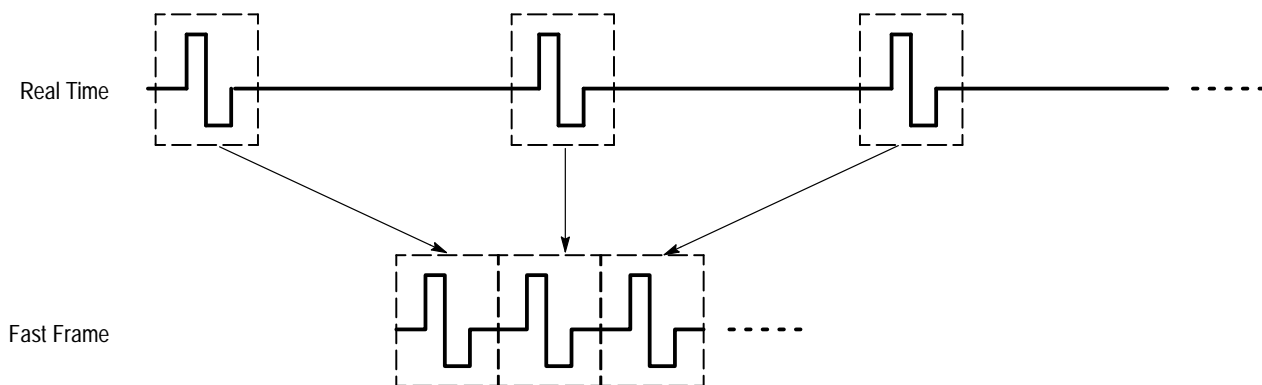

Figure 3–28: Fast Frame

If you are using the FastFrame mode, you can jump to the desired frame. To use FastFrame, do the following steps:

1. Press **HORIZONTAL MENU** → **FastFrame Setup** (main) → **FastFrame** (side) to toggle on or off the use of FastFrame (see Figure 3–29).
2. Press **Frame Length** or **Frame Count** (side) and use the general purpose knob to enter FastFrame parameters.
 - Frame Length refers to the number of samples in each acquisition.
 - Frame count refers to the number of acquisitions to store in the acquisition memory of the channel. The oscilloscope will set the record length to a value greater than or equal to the product of the frame count and the frame length. If the product exceeds the maximum available record length, the oscilloscope will reduce the frame length or frame count in size such that the product will fit the record length.
3. Press **Horiz Pos** (main), then **Frame** (side), and use the general purpose knob to enter the number of a specific frame to view. After you press **Enter**, that frame should appear on the display.

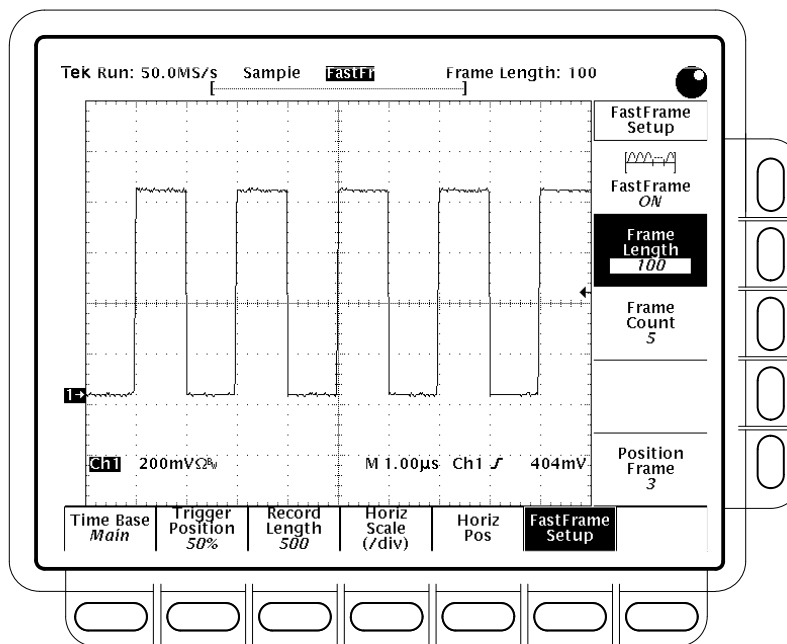

Figure 3–29: Horizontal Menu — FastFrame Setup

If you shift the waveform right or left with the front-panel **HORIZONTAL POSITION** knob, the window next to the side-menu **Frame** button will indicate the frame number of the waveform at the center of the screen.

FastFrame Operating Characteristics. Consider the following operating characteristics when using FastFrame:

- Envelope, Average, and Hi Res form the envelope or average following the last frame of the concatenated record. For example, if Average or Hi Res acquisition modes are selected and the frame count is 10, segments 1 through 10 will show Sample or Hi Res frames, and frame 11 will show the average of frames 1 through 10. If there is not room for one additional frame, the envelope or average of the frames replaces the display of the last acquired frame. Average and envelope counts have no affect in FastFrame.
- You can press **RUN/STOP** to terminate a FastFrame sequence. If any frames were acquired, they are displayed. If no frames were acquired, the previous FastFrame waveform is displayed.
- Because FastFrame waveforms contain many triggers, trigger position indicators are removed from both the waveform and the record view when the selected channel, reference, or math waveform is a FastFrame waveform.
- In Equivalent Time, the oscilloscope ignores FastFrame mode.
- Because FastFrame introduces additional processing time into the operation cycle of acquire, process, and display, its best to use Single Sequence Acquisition (see Acquire menu, Stop After menu). With Single Sequence selected, you will see the current acquisition sequence; otherwise, the display lags the current sequence by one sequence. You can also see the current sequence by pressing the RUN/STOP button to stop the acquisition.

Triggering on Waveforms

To use the TDS Oscilloscope to measure or monitor waveforms, you need to know how to trigger a stable display of those waveforms. Toward that end, this section first covers the following topics:

- *Trigger Concepts* which details some basic principles of triggering and describes triggering elements: *type, source, coupling, holdoff, mode,* and so on
- *Triggering from the Front Panel* which describes how to use the front-panel triggering controls each of which is common to most, if not all, the trigger types the oscilloscope provides

Once these basics are covered, this section describes how to trigger using the various trigger types provided by the Main trigger system: *edge, logic, and pulse.*

- To use the “general purpose” trigger type, edge, see *Triggering on a Waveform Edge* on page 3–57.
- To logic trigger based on an input pattern, state, or setup/hold violation, see *Triggering Based on Logic* on page 3–60.
- To pulse trigger based on various pulse types (glitch, runt) or their parameters (width, slew rate) see *Triggering on Pulses* on page 3–70.

This section concludes with details about and instructions for using the *Delayed time base* and *Delayed trigger system* to delay the acquisition of a waveform relative to a trigger event. (See *Delayed Triggering* on page 3–80.)

Triggering Concepts

Triggers determine when the oscilloscope starts acquiring and displaying a waveform. They help create meaningful waveforms from unstable jumbles or blank screens. (See Figure 3–30.) The oscilloscope has four types of triggers: edge, logic, pulse, and, with option 5, video.

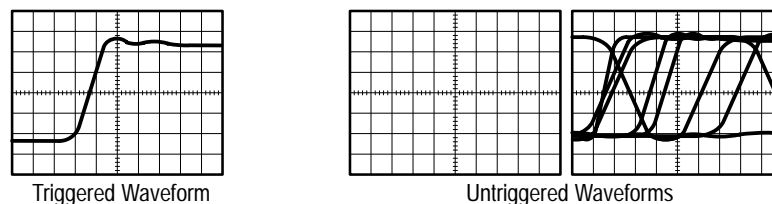

Figure 3–30: Triggered Versus Untriggered Displays

The Trigger Event

The trigger event establishes the time-zero point in the waveform record. All points in the record are located in time with respect to that point. The oscilloscope continuously acquires and retains enough sample points to fill the pretrigger portion of the waveform record (that part of the waveform that is displayed *before*, or to the left of, the triggering event on screen). When a trigger event occurs, the oscilloscope starts acquiring samples to build the posttrigger portion of the waveform record (displayed *after*, or to the right of, the trigger event). Once a trigger is recognized, the digitizing oscilloscope will not accept another trigger until the acquisition is complete.

Trigger Sources

You can derive your trigger from the following sources:

Input channels provide the most commonly used trigger source. You can select any one of the four input channels. The channel you select as a trigger source will function whether it is displayed or not.



AC Line Voltage is the trigger source most often used when you are looking at signals related to the power line frequency. Examples include devices such as lighting equipment and power supplies. Because the oscilloscope generates the trigger, you do not have to input a signal to create the trigger.

Auxiliary Trigger is the trigger source most often used in doing digital design and repair. For example, you might want to trigger with an external clock or with a signal from another part of the circuit. To use the auxiliary trigger, connect the external triggering signal to the Auxiliary Trigger input connector on the oscilloscope rear panel.

Trigger Types

The digitizing oscilloscope provides three standard triggers for the main trigger system: edge, pulse, and logic. Option 05 provides a video trigger. The standard triggers are described individually starting on page 3–57. A brief definition of each type follows:



Edge is the “basic” trigger. You can use it with both analog and digital test circuits. An edge trigger event occurs when the trigger *source* (the signal the trigger circuit is monitoring) passes through a specified voltage level in the specified direction (the trigger slope).



Pulse is a special-purpose trigger primarily used on digital circuits. The four classes of pulse triggers are *glitch*, *runt*, *width*, and *slew rate*. Pulse triggering is available on the main trigger only.

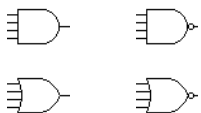

Logic is a special-purpose trigger primarily used on digital logic circuits. Two of the classes, *pattern* and *state*, trigger based on the Boolean operator you select for the trigger sources. Triggering occurs when the Boolean conditions are satisfied. A third class, *setup/hold*, triggers when data in one trigger source changes state within the setup and hold times that you specify relative to a clock

in another trigger source. Logic triggers are available on the main trigger system only.



Video (available as option 05) is a special trigger used on video circuits. It helps you investigate events that occur when a video signal generates a horizontal or vertical sync pulse. Supported classes of video triggers include *NTSC*, *PAL*, *SECAM*, and high definition TV signals.

Trigger Modes

The trigger mode determines how the oscilloscope behaves in the absence of a trigger event. The oscilloscope provides two trigger modes, *normal* and *automatic*.

Normal trigger mode enables the oscilloscope to acquire a waveform only when it is triggered. If no trigger occurs, the oscilloscope will not acquire a waveform. (You can push **FORCE TRIGGER** to force the oscilloscope to make a single acquisition.)

Automatic trigger mode (auto mode) enables the oscilloscope to acquire a waveform even if a trigger does not occur. Auto mode uses a timer that starts after a trigger event occurs. If another trigger event is not detected before the timer times out, the oscilloscope forces a trigger anyway. The length of time it waits for a trigger event depends on the time base setting. (Auto mode triggering is not available in InstaVu mode (TDS 700A models only); see *Incompatible Modes* on page 3–45.)

Be aware that auto mode, when forcing triggers in the absence of valid triggering events, does not sync the waveform on the display. In other words, successive acquisitions will not be triggered at the same point on the waveform; therefore, the waveform will appear to roll across the screen. Of course, if valid triggers occur the display will become stable on screen.

Since auto mode will force a trigger in the absence of one, auto mode is useful in observing signals where you are only concerned with monitoring amplitude level. Although the unsynced waveform may “roll” across the display, it will not freeze as it would in normal trigger mode. Monitoring of a power supply output is an example of such an application.

Trigger Holdoff

When the oscilloscope recognizes a trigger event, it disables the trigger system until acquisition is complete. In addition, the trigger system remains disabled during the holdoff period that follows each acquisition. You can set holdoff time to help ensure a stable display.

For example, the trigger signal can be a complex waveform with many possible trigger points on it. Though the waveform is repetitive, a simple trigger might get you a series of patterns on the screen instead of the same pattern each time.

A digital pulse train is a good example of a complex waveform. (See Figure 3–31.) Each pulse looks like any other, so many possible trigger points exist.

Not all of these will result in the same display. The holdoff period allows the oscilloscope to trigger on the correct edge, resulting in a stable display.

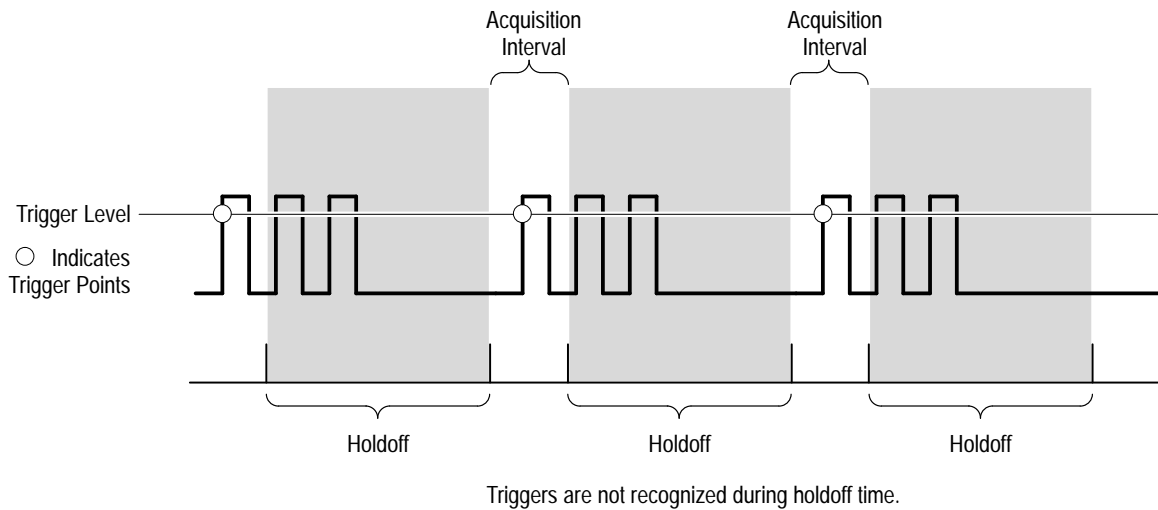

Figure 3-31: Trigger Holdoff Time Ensures Valid Triggering

Holdoff is settable from 250 ns (minimum holdoff available) to 12 seconds (maximum holdoff available). To see how to set holdoff, see *To Set Mode & Holdoff* on page 3-59.

You can also set a default holdoff. The default hold is the “general purpose” holdoff for most triggering signals and varies with the horizontal scale. It is equal to 5 divisions times the current time/division settings.

Trigger Coupling

Trigger coupling determines what part of the signal is passed to the trigger circuit. All trigger types except edge triggering use only DC coupling; edge triggering can use all available coupling types: AC, DC, Low Frequency Rejection, High Frequency Rejection, and Noise Rejection: See *To Specify Coupling* on page 3-58 for a description of each coupling mode.

Trigger Position

The adjustable feature *trigger position* defines where on the waveform record the trigger occurs. It lets you properly align and measure data within records. The part of the record that occurs *before* the trigger is the pretrigger portion. The part that occurs *after* the trigger is the posttrigger portion.

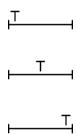

To help you visualize the trigger position setting, the top part of the display has an icon indicating where the trigger occurs in the waveform record. You select in the Horizontal menu what percentage of the waveform record will contain pretrigger information.

Displaying pretrigger information can be valuable when troubleshooting. For example, if you are trying to find the cause of an unwanted glitch in your test circuit, it might trigger on the glitch and make the pretrigger period large enough to capture data before the glitch. By analyzing what happened before the glitch, you may uncover clues about its source.

Slope and Level



The slope control determines whether the oscilloscope finds the trigger point on the rising or the falling edge of a signal. (See Figure 3–32.)

You set trigger slope by first selecting Slope in the Main Trigger menu and then selecting between the rising or falling slope icons in the side menu that appears.

The level control determines where on that edge the trigger point occurs. (See Figure 3–32.) The oscilloscope lets you set the main trigger level with the trigger MAIN LEVEL knob.

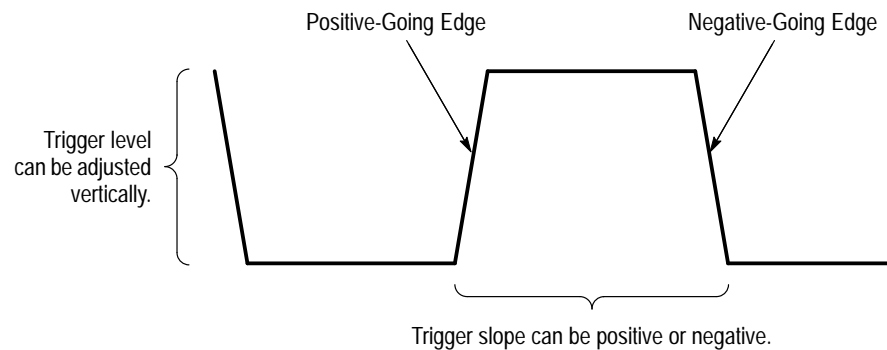

Figure 3–32: Slope and Level Controls Help Define the Trigger

Delayed Trigger System

The oscilloscope also has a delayed trigger system that provides an edge trigger (no pulse or logic triggers). When using the delayed time base, you can also delay the acquisition of a waveform for a user-specified time or a user-specified number of delayed trigger events (or both) after a main trigger event. See *Delayed Triggering* on page 3–80 to learn how to use delay.

Triggering from the Front Panel

The trigger buttons and knob let you quickly adjust the trigger level or force a trigger. (See Figure 3–33.) The trigger readout and status screen lets you quickly determine the state of the trigger system. You use the following trigger controls and readouts for all trigger types except where noted.

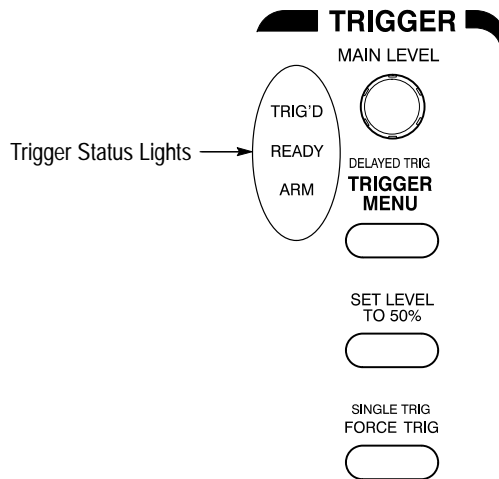

Figure 3-33: TRIGGER Controls and Status Lights

To set MAIN LEVEL

To manually change the trigger level when edge triggering (or certain threshold levels when logic or pulse triggering), turn the **MAIN LEVEL** knob. It adjusts the trigger level (or threshold level) instantaneously no matter what menu, if any, is displayed.

To Set to 50%

To quickly obtain an edge trigger or a glitch or width pulse trigger, press **SET LEVEL TO 50%**. The oscilloscope sets the trigger level to the halfway point between the peaks of the trigger signal. Set Level to 50% has no effect when trigger type is logic or video.

You can also set the level to 50% in the Trigger menu under the main menu item Level if edge trigger or glitch or width pulse trigger is selected.

Note that the **MAIN LEVEL** knob and menu items apply only to the main trigger level. To modify the delayed trigger level, use the Level item in the Delayed Trigger menu.

To Force a Trigger

To force the oscilloscope to immediately start acquiring a waveform record even without a trigger event, press the **FORCE TRIG** front panel button.

Forcing a trigger is useful when in normal trigger mode and the input signal is not supplying a valid trigger. By pressing **FORCE TRIG**, you can quickly confirm that there is a signal present for the oscilloscope to acquire. Once that is established, you can determine how to trigger on it (press **SET LEVEL TO 50%**, check trigger source setting, and so on).

The oscilloscope recognizes and acts upon **FORCE TRIG** even when you press it before the end of pretrigger holdoff. However, the button has no effect if the acquisition system is stopped.

To Single Trigger

To trigger on the next valid trigger event and then stop, press **SHIFT FORCE TRIG**. Now press the **RUN/STOP** button each time you want to initiate the single sequence of acquisitions.

To leave Single Trig mode, press **SHIFT ACQUIRE MENU** → **Stop After** (main) → **RUN/STOP Button Only** (side).

See the description under *Stop After* on page 3–25 for further discussion of single sequence acquisitions.

(Single sequence triggering is not available in InstaVu mode; see *Incompatible Modes* on page 3–45.)

To Check Trigger Status

To ascertain the state and setup of the triggering circuit, use the *trigger status lights, readout, and screen*.

Trigger Status Lights. To quickly determine trigger status, check the three status lights **TRIG'D**, **READY**, and **ARM** in the Trigger control area. (See Figure 3–33.)

- When TRIG'D is lighted, it means the oscilloscope has recognized a valid trigger and is filling the posttrigger portion of the waveform.
- When READY is lighted, it means the oscilloscope can accept a valid trigger event and the oscilloscope is waiting for that event to occur.
- When ARM is lighted, it means the trigger circuitry is filling the pretrigger portion of the waveform record.
- When both TRIG'D and READY are lighted, it means the oscilloscope has recognized a valid main trigger and is waiting for a delayed trigger. When the oscilloscope recognizes a delayed trigger, it will fill in the posttrigger portion of the delayed waveform.
- When ARM, TRIG'D, and READY are all off, the digitizer is stopped.
- When ARM, TRIG'D, and READY are all lighted (TDS 700A models only), FastFrame or InstaVu modes are in effect. No trigger status monitoring is taking place.

Trigger Readout. To quickly determine the settings of some key trigger parameters, check the Trigger readout at the bottom of the display. (See Figure 3–34.) The readouts differ for edge, logic, and pulse triggers.

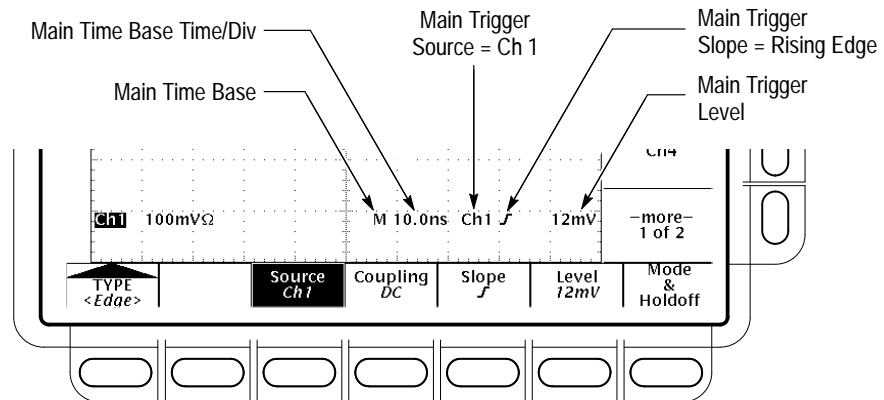

Figure 3-34: Example Trigger Readouts — Edge Trigger Selected

Record View. To determine where the trigger point is located in the waveform record and with respect to the display, check the record view at the top of the display. (See Figure 3-35.)

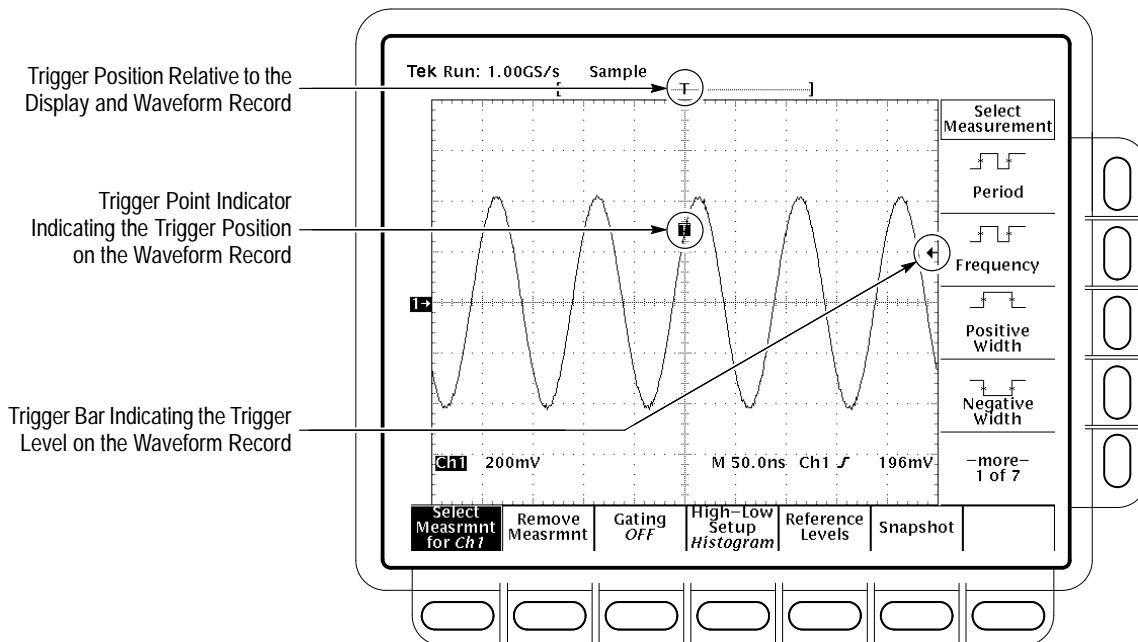

Figure 3-35: Record View, Trigger Position, and Trigger Level Bar Readouts

Trigger Position and Level Indicators. To see the trigger point and level on the waveform display, check the graphic indicators *Trigger Position* and *Trigger Bar*. Figure 3-35 shows the trigger point indicator and trigger level bar.

Both the trigger point indicator and level bar are displayed from the Display menu. See *Set Display Readout Options* on page 3–29 for more information.

The trigger point indicator shows position. It can be positioned horizontally off screen, especially with long record length settings. The trigger level bar shows only the trigger level. It remains on screen, regardless of the horizontal position, as long as the channel providing the trigger source is displayed.

Trigger Status Screen. To see a more comprehensive status listing of the settings for the main and delayed trigger systems, press **SHIFT STATUS** → **STATUS** (main) → **Trigger** (side).

Trigger Menu Each trigger type (edge, logic, and pulse) has its own main trigger menu, which is described as each type is discussed in this section. To select the trigger type, press **TRIGGER MENU** → **Type** (main) → **Edge, Logic, or Pulse** (pop-up).

Triggering on a Waveform Edge

The TDS Oscilloscope can trigger on an edge of a waveform. An *edge trigger* event occurs when the trigger source passes through a specified voltage level in a specified direction (the trigger slope). You will likely use edge triggering for most of your measurements. This subsection describes how use edge triggering — how to select edge type, source, coupling, slope, and level. It also details how to select trigger mode, auto or normal, for *all* trigger types.

To Check Edge Trigger Status To quickly check if edge triggers are selected, check the Trigger readout. When edge triggers are selected, the trigger readout displays the trigger source, as well as the trigger slope and level. (See Figure 3–36.)

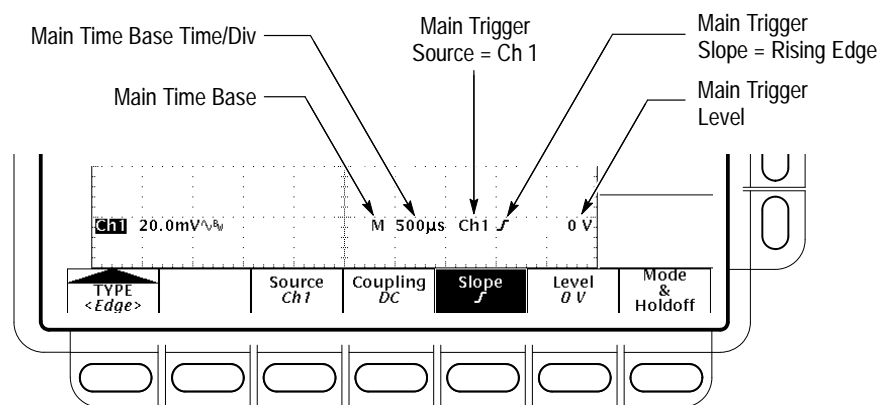

Figure 3–36: Edge Trigger Readouts

To Select Edge Triggering

Use the edge trigger menu to select edge triggering and to perform the procedures for source, coupling, slope, trigger level, mode, and holdoff that follow.

To bring up the Edge Trigger menu, press **TRIGGER MENU** → **Type** (main) → **Edge** (pop-up). (See Figure 3–37.)

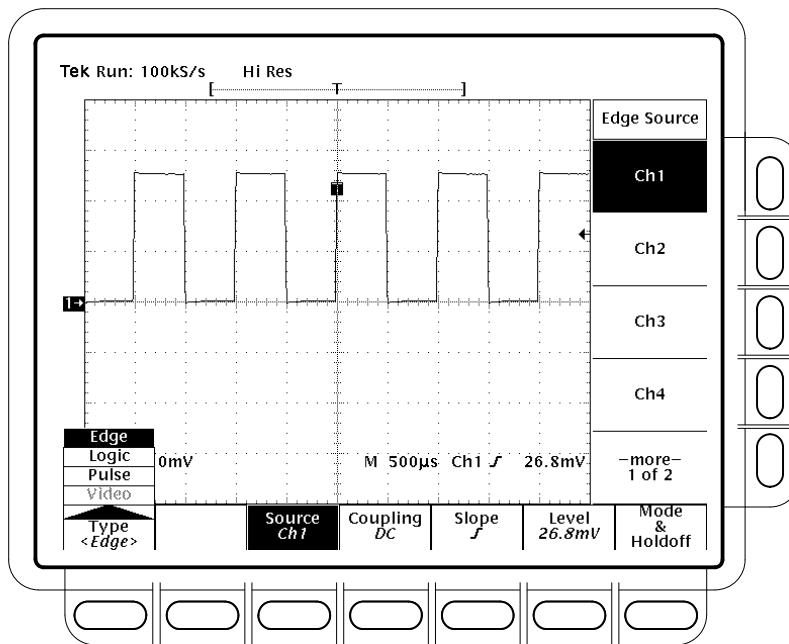

Figure 3–37: Main Trigger Menu — Edge Type

To Select a Source

To select which source you want for the trigger:

Press **TRIGGER MENU** → **Type** (main) → **Edge** (pop-up) → **Source** (main) → **Ch1, Ch2, Ch3, Ch4, AC Line, or DC Aux** (side).

To Specify Coupling

To select the coupling you want, press **TRIGGER MENU** → **Type** (main) → **Edge** (pop-up) → **Coupling** (main) → **DC, AC, HF Rej, LF Rej, or Noise Rej** (side).

DC

DC passes all of the input signal. In other words, it passes both AC and DC components to the trigger circuit.

AC 

AC passes only the alternating components of an input signal. It removes the DC component from the trigger signal.



HF Rej removes the high frequency portion of the triggering signal. That allows only the low frequency components to pass on to the triggering system to start an acquisition. High frequency rejection attenuates signals above 30 kHz.



LF Rej removes the low frequency portion of the triggering signal. Low frequency rejection attenuates signals below 80 kHz.



Noise Rej provides lower sensitivity. Noise Rej requires additional signal amplitude for stable triggering, reducing the chance of falsely triggering on noise.

NOTE. When you select *Line* as the trigger source, the oscilloscope uses AC coupling to couple a sample of the AC line voltage to the trigger circuits. Although trigger coupling can be set to other than AC when in *Line*, the oscilloscope ignores the setting until another source (one of Ch1 through Ch4) is selected.

In similar fashion, when you select *DC Aux (Rear Panel)* as the trigger source, the oscilloscope uses DC coupling to couple an auxiliary signal to the trigger circuits. Although trigger coupling can be set to other than DC when in *DC Aux*, the oscilloscope ignores the setting until one of Ch1 through Ch4 is selected.

To Set Mode & Holdoff

You can change the holdoff time and select the trigger mode using this menu item. See *Trigger Modes* and *Trigger Holdoff* beginning on page 3–51 for a description of these features. To set mode and holdoff, do the following steps:

1. Press the **TRIGGER MENU** → **Mode & Holdoff** (main) → **Auto** or **Normal** (side). The modes operate as follows:
 - In Auto mode the oscilloscope acquires a waveform after a specific time has elapsed even if a trigger does not occur. The amount of time the oscilloscope waits depends on the time base setting. (Auto mode triggering is not available in InstaVu mode; see *Incompatible Modes* on page 3–45.)
 - In Normal mode the oscilloscope acquires a waveform only if there is a valid trigger.
2. To change the holdoff time, press **Holdoff** (side). Enter the value in time using the general purpose knob or the keypad.

If you want to enter a large number using the general purpose knob, press the **SHIFT** button before turning the knob. When the light above the **SHIFT** button is on and the display says **Coarse Knobs** in the upper right corner, the general purpose knob speeds up significantly.

You can set holdoff from 250 ns (minimum holdoff available) to 12 seconds (maximum available). See *Holdoff, Variable, Main Trigger* in the *TDS 684A, TDS 744A, and TDS 784A Performance Verification and Specifications* manual for typical minimum and maximum values.

3. To change to the factory default holdoff setting for the current horizontal scale setting, press **Default Holdoff** (side).

NOTE. If you select *Default Holdoff*, the default holdoff time will vary with the horizontal scale setting to maintain a good value for general purpose triggering at that scale. However, if you select *Holdoff* (as opposed to *Default Holdoff*), the time set in the *Holdoff* menu item is used at all horizontal scale settings.

To Set Slope

To select the slope that the edge trigger will occur on:

1. Press the **TRIGGER MENU** → **Type** (main) → **Edge** (pop-up) → **Slope** (main).



2. Select the rising or falling edge from the side menu.

To Set Level

Press the **TRIGGER MENU** → **Type** (main) → **Edge** (pop-up) → **Level** (main) → **Level, Set to TTL, Set to ECL, or Set to 50%** (side).

Level lets you enter the trigger level using the general purpose knob or the keypad.

Set to TTL fixes the trigger level at +1.4 V.

Set to ECL fixes the trigger level at -1.3 V.

NOTE. When you set the volts/div smaller than 200 mV, the oscilloscope reduces the **Set to TTL** or **Set to ECL** trigger levels below standard TTL and ECL levels. This reduction occurs because the trigger level range is fixed at ± 12 divisions from the center. At 100 mV (the next smaller setting after 200 mV) the trigger range is ± 1.2 V, which is smaller than the typical TTL (+1.4 V) or ECL (-1.3 V) level.

Set to 50% fixes the trigger level to approximately 50% of the peak-to-peak value of the trigger source signal.

Triggering Based on Logic

The TDS Oscilloscope can trigger on a logic or binary pattern and on the state of a logic pattern at the time it is clocked. It can also trigger on data that violates

setup and hold times relative to a clock. This subsection describes how to use these three classes of logic triggering: *pattern*, *state*, and *setup/hold*.

A *pattern* trigger occurs when the logic inputs to the logic function you select cause the function to become TRUE (or at your option FALSE). When you use a pattern trigger, you define:

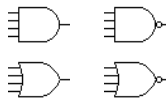

- The precondition for each logic input — logic high, low, or do not care (the logic inputs are channels 1, 2, 3, and 4)
- The Boolean logic function — select from AND, NAND, OR, and NOR
- The condition for triggering — whether the trigger occurs when the Boolean function becomes TRUE (logic high) or FALSE (logic low), and whether the TRUE condition is time qualified

A *state* trigger occurs when the logic inputs to the logic function cause the function to be TRUE (or at your option FALSE) *at the time* the clock input changes state. When you use a state trigger, you define:

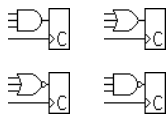

- The precondition for each logic input, channels 1, 2, and 3
- The direction of the state change for the clock input, channel 4
- The Boolean logic function — select from clocked AND, NAND, OR, and NOR
- The condition for triggering — whether the trigger occurs when the Boolean function becomes TRUE (logic high) or FALSE (logic low)

A *setup/hold* trigger occurs when a logic input changes state inside of the setup and hold times relative to the clock. When you use setup/hold triggering, you define:

- The channel containing the logic input (the data source) and the channel containing the clock (the clock source)
- The direction of the clock edge to use
- The clocking level and data level that the oscilloscope uses to determine if a clock or data transition has occurred
- The setup and hold times that together define a time range relative to the clock









Pattern and State Classes

Pattern and state triggers apply boolean logic functions to the logic inputs. Table 3–7 defines these four logic functions.

For *pattern* triggering, the oscilloscope waits until the end of trigger holdoff and then samples the inputs from all the channels. The oscilloscope then triggers if the conditions defined in Table 3–7 are met. (Goes TRUE or Goes FALSE must be set in the Trigger When menu. The other settings in that menu are described in *To Define a Time Qualified Pattern Trigger* on page 3–66.)

For *state* triggering, the oscilloscope waits until the end of trigger holdoff and then waits until the edge of channel 4 transitions in the specified direction. At that point, the oscilloscope samples the inputs from the other channels and triggers if the conditions defined in Table 3–7 are met.

Table 3–7: Pattern and State Logic

Pattern	State	Definition ^{1, 2}
 AND	 Clocked AND	If <i>all</i> the preconditions selected for the logic inputs ³ are TRUE, then the oscilloscope triggers.
 NAND	 Clocked NAND	If <i>not all</i> of the preconditions selected for the logic inputs ³ are TRUE, then the oscilloscope triggers.
 OR	 Clocked OR	If <i>any</i> of the preconditions selected for the logic inputs ³ are TRUE, then the oscilloscope triggers.
 NOR	 Clocked NOR	If <i>none</i> of the preconditions selected for the logic inputs ³ are TRUE, then the oscilloscope triggers.

- ¹ Note that for state class triggers, the definition must be met at the time the clock input changes state.
- ² The definitions given here are correct for the Goes TRUE setting in the Trigger When menu. If that menu is set to Goes False, swap the definition for AND with that for NAND and for OR with NOR for both pattern and state classes.
- ³ The logic inputs are channels 1, 2, 3, and 4 when using pattern logic triggers. For State Logic Triggers, channel 4 becomes the clock input, leaving the remaining channels as logic inputs.

Setup and Hold Class

Setup/hold triggering uses the setup and hold times to define a “setup/hold violation zone” relative to the clock. Data that changes state within this zone triggers the oscilloscope. Figure 3–38 shows how the setup and hold times you choose position this zone relative to the clock.

Setup/hold triggering uses the setup/hold violation zone to detect when data is unstable too near the time it is clocked. Each time trigger holdoff ends, the oscilloscope monitors the data and clock sources. When a clock edge occurs, the oscilloscope checks the data stream it is processing (from the data source) for transitions occurring within the setup/hold violation zone. If any occur, the oscilloscope triggers *with the trigger point located at the clock edge*.

Positive settings for both setup and hold times (the most common application) locate the setup/hold violation zone so it *spans* the clocking edge. (See the top waveform in Figure 3–38.) The oscilloscope detects and triggers on data that

does not become stable long enough before the clock (setup time violation) or that does not stay stable long enough after the clock (hold time violation).

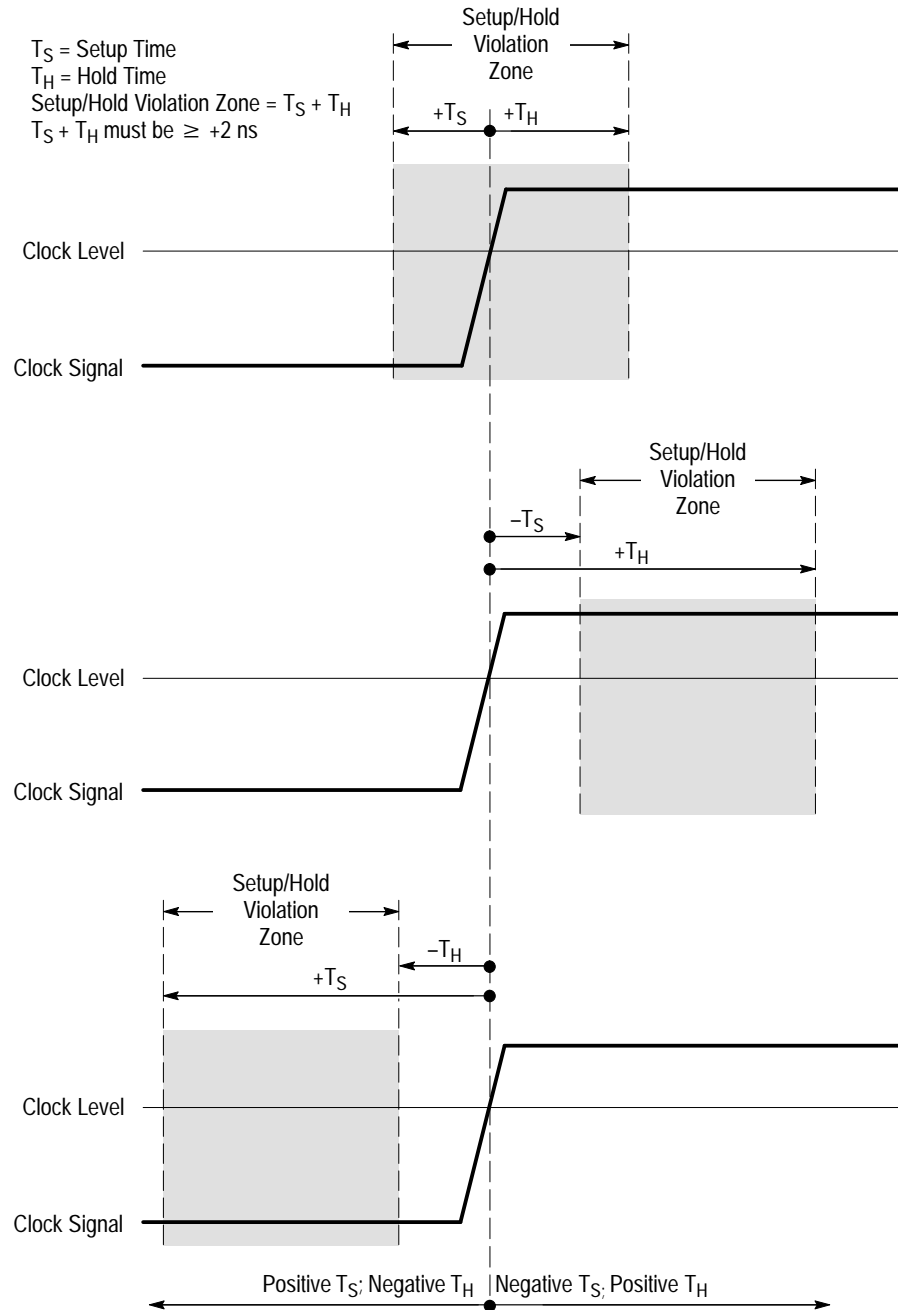

Figure 3–38: Violation Zones for Setup/Hold Triggering

Negative settings for setup or hold times skew the setup/hold violation zone to locate it before or after the clocking edge. (See the bottom and center waveforms

of Figure 3–38.) The oscilloscope can then detect and trigger on violations of a time *range* that occurs *before* or one that occurs *after* the clock.

NOTE. Keep hold time to at least 2 ns less than the clock period or the oscilloscope cannot trigger.

To Check Logic Trigger Status

To quickly check if logic triggers are selected and if so, what class, check the Trigger readout. When logic triggers are selected, the trigger readout displays the selected logic trigger class: *Pattern*, *State*, or *StHld* (Setup/Hold). (See Figure 3–39.)

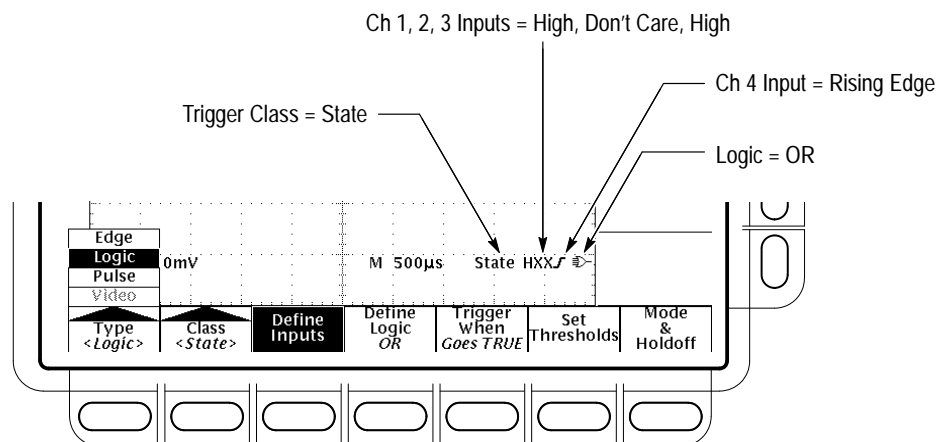

Figure 3–39: Logic Trigger Readouts — State Class Selected

NOTE. When the trigger type *Logic* is selected, the trigger levels must be set for each channel individually in the *Set Thresholds* menu (*pattern* and *state* classes) or the *Levels* (*setup/hold* class) menu. Therefore, the *Trigger Level* readout will disappear on the display and the *Trigger Level* knob can be used to set the selected level while the *Main Trigger* menu is set to *Logic*.

To Trigger on a Pattern

When you select the logic class *Pattern*, the oscilloscope will trigger on a specified logic combination of the four input channels. (Pages 3–60 through 3–62 describe how pattern triggers work.) To use pattern triggering, do the procedures that follow:

Select Pattern Triggering. Press **TRIGGER MENU** → **Type** (main) → **Logic** (pop-up) → **Class** (main) → **Pattern** (pop-up).

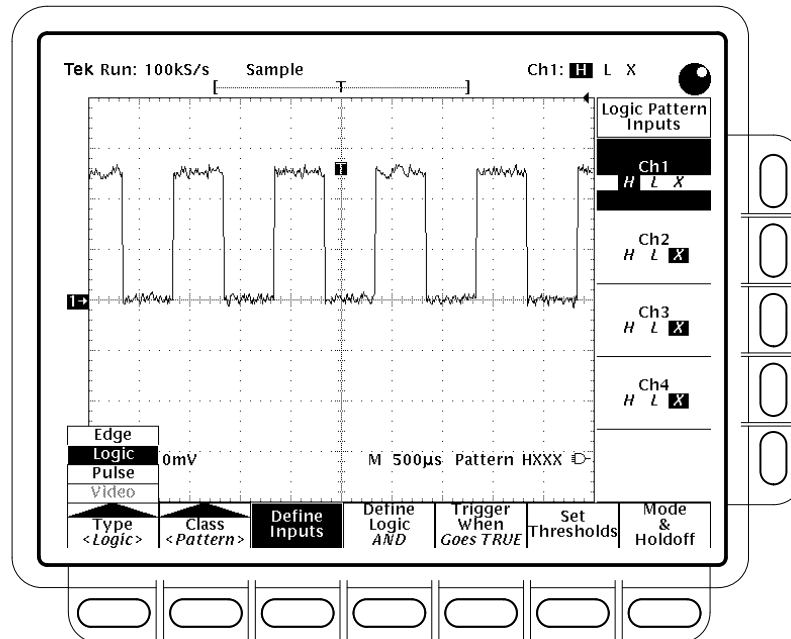

Figure 3-40: Logic Trigger Menu

To Define Pattern Inputs. To set the logic state for each of the input channels (Ch1, Ch2, ...):

1. Press **TRIGGER MENU** → **Type** (main) → **Logic** (pop-up) → **Class** (main) → **Pattern** (pop-up) → **Define Inputs** (main) → **Ch1, Ch2, Ch3, or Ch4** (side).
2. Repeatedly press each input selected in step 1 to choose either High (*H*), Low (*L*), or Don't Care (*X*) for each channel.

To Set Thresholds. To set the logic threshold for each channel:

1. Press **TRIGGER MENU** → **Type** (main) → **Logic** (pop-up) → **Class** (main) → **Pattern** (pop-up) → **Set Thresholds** (main) → **Ch1, Ch2, Ch3, or Ch4** (side).
2. Use the **MAIN TRIGGER LEVEL** knob, the general purpose knob, or the keypad to set each threshold.

To Define the Logic. To choose the logic function you want applied to the input channels (see page 3–61 for definitions of the logic functions for both pattern and state triggers):

Press **TRIGGER MENU** → **Type** (main) → **Logic** (pop-up) → **Class** (main) → **Pattern** (pop-up) → **Define Logic** (main) → **AND, OR, NAND, or NOR** (side).

Set Trigger When. To choose to trigger when the logic condition is met (**Goes TRUE**) or when the logic condition is not met (**Goes FALSE**), do the following step:

Press **TRIGGER MENU** → **Type** (main) → **Logic** (pop-up) → **Class** (main) → **Pattern** (pop-up) → **Trigger When** (main) → **Goes TRUE or Goes FALSE** (side).

The side menu items TRUE for less than and TRUE for greater than are used to time qualify a pattern trigger. See the procedure *Define a Time Qualified Pattern Trigger* that follows for instructions.

To Set Mode and Holdoff. Mode and holdoff can be set for all standard trigger types and classes. To set mode and holdoff, refer to *To Set Mode & Holdoff* on page 3–59. To learn more about trigger mode and holdoff, see the descriptions *Trigger Modes* and *Trigger Holdoff* on page 3–51.

To Define a Time Qualified Pattern Trigger

You can also time qualify a pattern logic trigger. That is, you specify a time that the boolean logic function (AND, NAND, OR, or NOR) must be TRUE (logic high). To specify the time limit as well as the type of time qualification (greater or less than the time limit specified) for a pattern trigger, do the following steps:

1. Press **TRIGGER MENU** → **Type** (main) → **Logic** (pop-up) → **Class** (main) → **Pattern** (pop-up) → **Trigger When** (main) → **TRUE for less than or TRUE for more than** (side).
2. Use the knob and keypad to set the time in the side menu.

When you select TRUE for less than and specify a time, the input conditions you specify must drive the logic function high (TRUE) for less than the time you specify. Conversely, the TRUE for more than menu item requires the boolean function to be TRUE for longer than the time you specify.

Note the position of the trigger indicator in Figure 3–41. Triggering occurs at the point that the oscilloscope *determines* that the logic function you specify is TRUE within the time you specify. The oscilloscope determines the trigger point in the following manner:

- It waits for the logic condition to become TRUE.
- It starts timing and waits for the logic function to become FALSE.

- It compares the times and, if the time TRUE is longer (for TRUE for more than) or shorter (for TRUE for less than), then it triggers a waveform display *at the point the logic condition became FALSE*. This time can be, and usually is, different from the time set for TRUE for more than or TRUE for less than.

In Figure 3–41, the delay between the vertical bar cursors is the time the logic function is TRUE. Since this time is more (216 μ s) than that set in the TRUE for more than menu item (150 μ s), the oscilloscope issues the trigger at that point, not at the point at which it has been TRUE for 150 μ s.

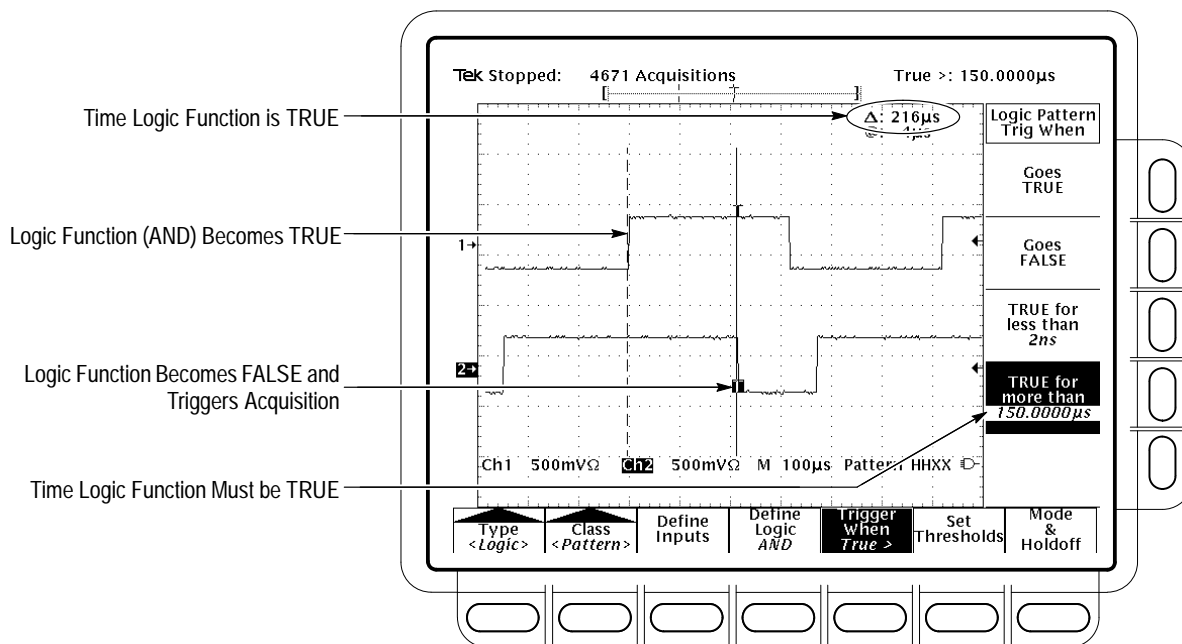

Figure 3–41: Logic Trigger Menu — Time Qualified TRUE

To State Trigger

When you select the logic class State, the oscilloscope uses channel 4 as a clock and triggers on a logic circuit made from the rest of the channels (pages 3–60 through 3–62 describe how state triggers work). To use state triggering, do the following procedures.

Select State Triggering. Press **TRIGGER MENU** → **Type** (main) → **Logic** (pop-up) → **Class** (main) → **State** (pop-up).

Define Inputs. To set the logic state for each of the input channels (**Ch1**, **Ch2**, ...):

1. Press **TRIGGER MENU** → **Type** (main) → **Logic** (pop-up) → **Class** (main) → **State** (pop-up) → **Define Inputs** (main).

2. Choose either High (*H*), Low (*L*), or Don't Care (*X*) (side) for the first three channels. The choices for **Ch4** are rising edge and falling edge.

Set Thresholds. To set the logic threshold for each channel:

1. Press **TRIGGER MENU** → **Type** (main) → **Logic** (pop-up) → **Class** (main) → **State** (pop-up) → **Set Thresholds** (main) → **Ch1, Ch2, Ch3, or Ch4** (side).
2. Use the **MAIN TRIGGER LEVEL** knob, the general purpose knob, or the keypad to set each threshold.

Define Logic. To choose the type of logic function you want applied to the input channels:

Press **TRIGGER MENU** → **Type** (main) → **Logic** (pop-up) → **Class** (main) → **State** (pop-up) → **Define Logic** (main) → **AND, OR, NAND, or NOR** (side).

Set Trigger When. To choose to trigger when the logic condition is met (Goes TRUE) or when the logic condition is not met (Goes FALSE):

Press **TRIGGER MENU** → **Type** (main) → **Logic** (pop-up) → **Class** (main) → **State** (pop-up) → **Trigger When** (main) → **Goes TRUE or Goes FALSE** (side).

To Set Mode and Holdoff. Mode and holdoff can be set for all standard trigger types and classes. To set mode and holdoff, refer to *To Set Mode & Holdoff* on page 3–59. To learn more about trigger mode and holdoff, see the descriptions *Trigger Modes* and *Trigger Holdoff* on page 3–51.

To Trigger on Setup/ Hold Time Violations

When you select the logic class Setup/Hold, the oscilloscope uses one channel as a data channel (the factory default setting is Ch1), another channel as a clock channel (default is Ch2), and triggers if the data transitions within the setup or hold time of the clock. (Pages 3–61 and 3–62 describe how setup/hold triggers work). To use setup and hold triggering, do the following procedures.

Select Setup/Hold Triggering. Press **TRIGGER MENU** → **Type** (main) → **Logic** (pop-up) → **Class** (main) → **Setup/Hold** (pop-up).

Define the Data Source. To select the channel that is to contain the data signal:

1. Press **TRIGGER MENU** → **Type** (main) → **Logic** (pop-up) → **Class** (main) → **Setup/Hold** (pop-up) → **Data Source** (main).
2. Press any one of **Ch1, Ch2, Ch3, or Ch4** (side). Do *not* select the same channel for both the data and clock sources.

Define the Clock Source and Edge. To select the channel that is to contain the clock signal and the edge to use to clock:

1. Press **TRIGGER MENU** → **Type** (main) → **Logic** (pop-up) → **Class** (main) → **Setup/Hold** (pop-up) → **Clock Source** (main) → **Ch1**, **Ch2**, **Ch3**, or **Ch4** (side).
2. Press any one of **Ch1**, **Ch2**, **Ch3**, or **Ch4** (side). Do *not* select the same channel that you selected for the clock source.
3. Press **Clock Edge** (side) to toggle between the rising and falling edges.

Set the Data and Clock Levels. To set the transition levels that the clock and data must cross to be recognized by the oscilloscope:

1. Press **TRIGGER MENU** → **Type** (main) → **Logic** (pop-up) → **Class** (main) → **Setup/Hold** (pop-up) → **Levels** (main) → **Clock Level** or **Data Level** (side).
2. Turn the general purpose knob or use the keypad to set values for the clock level and for the data level you select.

If you prefer, you can set both clock levels to a value appropriate to either of two logic families. To do so:

3. Press **TRIGGER MENU** → **Type** (main) → **Logic** (pop-up) → **Class** (main) → **Setup/Hold** (pop-up) → **Levels** (main) → **Set Both to TTL** or **Set Both to ECL** (side).

The oscilloscope uses the clock level you set to determine when a clock edge (rising or falling, depending on which you select) occurs. The oscilloscope uses the point the clock crosses the clock level as the reference point from which it measures setup and hold time settings.

Set the Setup and Hold Times. To set the setup time and the hold time relative to the clock:

1. Press **TRIGGER MENU** → **Type** (main) → **Logic** (pop-up) → **Class** (main) → **Setup/Hold** (pop-up) → **Set/Hold Times** (main) → **Setup Time** or **Hold Time** (side). See Figure 3–42.
2. Turn the general purpose knob or use the keypad to set values for the setup and for the hold times.

NOTE. Keep hold time to at least 2 ns less than the clock period or the oscilloscope cannot trigger.

Positive setup time always leads the clock edge; positive hold time always follows the clocking edge. Setup time always leads the hold time by at least 2 ns ($T_S + T_H \geq 2 \text{ ns}$). Attempting to set either time to reduce the 2 ns limit adjusts the other time to maintain the limit.

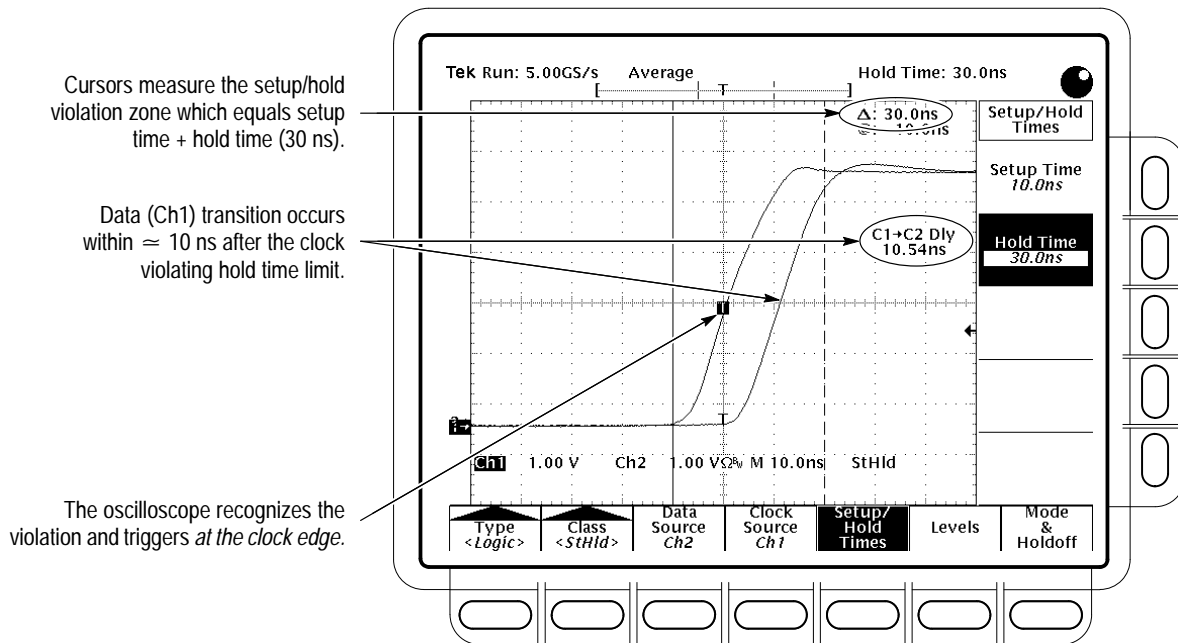

Figure 3-42: Triggering on a Setup/Hold Time Violation

In most cases, you will enter positive values for both setup and hold time. Positive values set the oscilloscope to trigger if the data source is still settling inside the setup time before the clock or if it switches inside the hold time after the clock. You can skew this “setup/hold violation zone” that the setup and hold times form by entering negative values. See Figure 3-38 on page 3-63.

To Set Mode and Holdoff. Mode and holdoff can be set for all standard trigger types and classes. To set mode and holdoff, refer to *To Set Mode & Holdoff* on page 3-59. To learn more about trigger mode and holdoff, see the descriptions *Trigger Modes* and *Trigger Holdoff* on page 3-51.

Triggering on Pulses

The TDS Oscilloscope can trigger on glitch or runt pulses, or it can trigger based on the width or slew rate of a pulse. These capabilities makes the oscilloscope suitable for such tasks as unattended monitoring for, and capturing of, a power supply glitch or GO/NO GO slew rate testing of operational amplifiers. This

subsection describes how to use each of the four classes of pulse triggers: *glitch*, *runt*, *width*, and *slew rate* triggering.

A *glitch* trigger occurs when the trigger source detects a pulse narrower (or wider) in width than some specified time. It can trigger on glitches of either polarity. Or you can set the glitch trigger to reject glitches of either polarity.

A *runt* trigger occurs when the trigger source detects a short pulse that crosses one threshold but fails to cross a second threshold before recrossing the first. You can set the oscilloscope to detect positive or negative runt pulses.

A *width* trigger occurs when the trigger source detects a pulse that is inside or, optionally, outside some specified time range (defined by the upper limit and lower limit). The oscilloscope can trigger on positive or negative width pulses.

A *slew rate* trigger occurs when the trigger source detects a pulse edge that traverses (slews) between two amplitude levels at a rate faster than or slower than you specify. The oscilloscope can trigger on positive or negative slew rates. You can also think of slew rate triggering as triggering based on the slope (change in voltage/change in time) of a pulse edge.

Figure 3–43 shows the pulse trigger readout. Table 3–8, on page 3–71, describes the choices for pulse triggers.

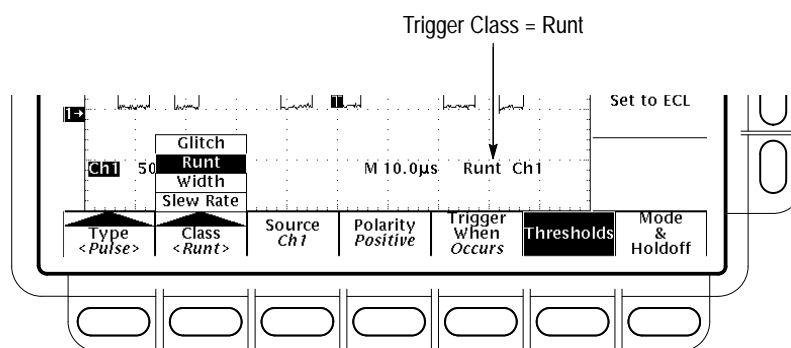

Figure 3–43: Pulse Trigger Readouts

Table 3–8: Pulse Trigger Definitions











Name	Definition
 Glitch positive	Triggering occurs if the oscilloscope detects positive spike widths less than the specified glitch time.
 Glitch negative	Triggering occurs if the oscilloscope detects negative spike widths less than the specified glitch time.
 Glitch either	Triggering occurs if the oscilloscope detects positive or negative widths less than the specified glitch time.

Table 3–8: Pulse Trigger Definitions (Cont.)

Name	Definition
 Runt positive	Triggering occurs if the oscilloscope detects a positive pulse that crosses one threshold going positive but fails to cross a second threshold before recrossing the first going negative.
 Runt negative	Triggering occurs if the oscilloscope detects a negative going pulse that crosses one threshold going negative but fails to cross a second threshold before recrossing the first going positive.
 Runt either	Triggering occurs if the oscilloscope detects a positive or negative going pulse that crosses one threshold but fails to cross a second threshold before recrossing the first.
 Width positive	Triggering occurs if the oscilloscope finds a positive pulse with a width between, or optionally outside, the user-specified lower and upper time limits.
 Width negative	Triggering occurs if the oscilloscope finds a negative pulse with a width between, or optionally outside, the user-specified lower and upper time limits.
 Slew Positive	Triggering occurs if the oscilloscope detects a positive pulse edge that after first crossing the lower threshold then crosses the upper threshold. The pulse must travel between the two levels at a rate faster or slower than (user specifies) the user-specified slew rate for triggering to occur.
 Slew Negative	Triggering occurs if the oscilloscope detects a negative pulse edge that after first crossing the upper threshold then crosses the lower threshold. The pulse must travel between the two levels at a rate faster or slower than (user specifies) the user-specified slew rate for triggering to occur.
 Slew either	Triggering occurs if the oscilloscope detects a positive or negative pulse edge that first crosses one threshold and then crosses the other threshold. The pulse must travel between the two levels at a rate faster or slower than (user specifies) the user-specified slew rate for triggering to occur.

To Trigger on a Glitch

When you select the pulse class **Glitch**, the oscilloscope will trigger on a pulse narrower (or wider) in width than some specified time. To set up for glitch triggering, do the following procedures.

Select Glitch Triggering. Press **TRIGGER MENU** → **Type** (main) → **Pulse** (pop-up) → **Class** (main) → **Glitch** (pop-up).

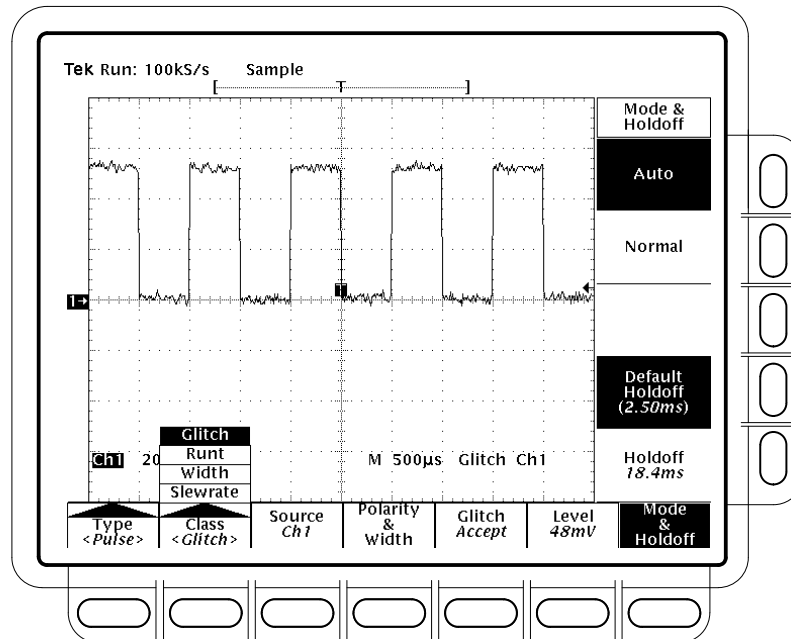

Figure 3–44: Main Trigger Menu — Glitch Class

Select the Source. To specify which channel becomes the pulse trigger source:

Press **TRIGGER MENU** → **Type** (main) → **Pulse** (pop-up) → **Source** (main) → **Ch1, Ch2, Ch3, or Ch4** (side). The source selected becomes the trigger source for all four trigger classes.

Select the Polarity & Width. To specify polarity (positive, negative, or either) and width of the glitch, do the following steps:

1. Press **TRIGGER MENU** → **Type** (main) → **Pulse** (pop-up) → **Polarity & Width** (main) → **Positive, Negative, or Either** (side).



Positive looks at positive-going pulses.



Negative looks at negative-going pulses.



Either looks at both positive and negative pulses.



2. Press **Width** (side), and set the glitch width using the general purpose knob or keypad.

Set to Accept or Reject Glitch. To specify whether to trigger on glitches or ignore glitches, press **TRIGGER MENU** → **Type** (main) → **Pulse** (pop-up) → **Class** (main) → **Glitch** (pop-up) → **Glitch** (main) → **Accept Glitch or Reject Glitch** (side).

If you choose **Accept Glitch**, the oscilloscope will trigger only on pulses narrower than the width you specified. If you select **Reject Glitch**, it will trigger only on pulses wider than the specified width.

Set the Level. To set the trigger level with the **Level** main menu (or the front panel trigger **LEVEL** knob), press **TRIGGER MENU** → **Type** (main) → **Pulse** (pop-up) → **Level** (main) → **Level**, **Set to TTL**, **Set to ECL**, or **Set to 50%** (side).

- If you select **Level**, you set the trigger level by entering a value with the general purpose knob or the keypad.
- If you select **Set to TTL**, the oscilloscope sets the trigger level to the TTL switching threshold.
- If you select **Set to ECL**, the oscilloscope sets the trigger level to the ECL switching threshold.
- If you select **Set to 50%**, the oscilloscope searches for the point halfway between the peaks of the trigger source signal and sets the trigger level to that point.

To Set Mode and Holdoff. Mode and holdoff can be set for all standard trigger types and classes. To set mode and holdoff, refer to *To Set Mode & Holdoff* on page 3–59. To learn more about trigger mode and holdoff, see the descriptions *Trigger Modes* and *Trigger Holdoff* on page 3–51.

To Trigger on a Runt Pulse

When you select the pulse class **Runt**, the oscilloscope will trigger on a short pulse that crosses one threshold but fails to cross a second threshold before recrossing the first. To set up for runt triggering, do the following procedures.

Select Runt Triggering. Press **TRIGGER MENU** → **Type** (main) → **Pulse** (pop-up) → **Class** (main) → **Runt** (pop-up). (See Figure 3–45.)

Select the Source. To specify which channel becomes the pulse trigger source:

Press **TRIGGER MENU** → **Type** (main) → **Pulse** (pop-up) → **Source** (main) → **Ch1**, **Ch2**, **Ch3**, or **Ch4** (side). The source selected becomes the trigger source for all four trigger classes.

Select the Polarity. To specify the direction of the runt pulse:

Press **TRIGGER MENU** → **Type** (main) → **Pulse** (pop-up) → **Class** (main) → **Runt** (pop-up) → **Polarity** (main) → **Positive**, **Negative**, or **Either** (side).

Positive looks for positive-going runt pulses.

Negative looks for negative-going runt pulses.

Either looks for both positive and negative runt pulses.

Set to Trig When. To determine how wide a runt pulse the oscilloscope will trigger on:

1. Press **TRIGGER MENU** → **Type** (main) → **Pulse** (pop-up) → **Class** (main) → **Runt** (pop-up) → **Trig When** (main).
2. Press **Occurs** to trigger on all runt pulses regardless of width.
3. Press **Runt is Wider Than** (side) to trigger only on runt pulses that exceed the width you set. Enter the width using the general purpose knob or keypad.

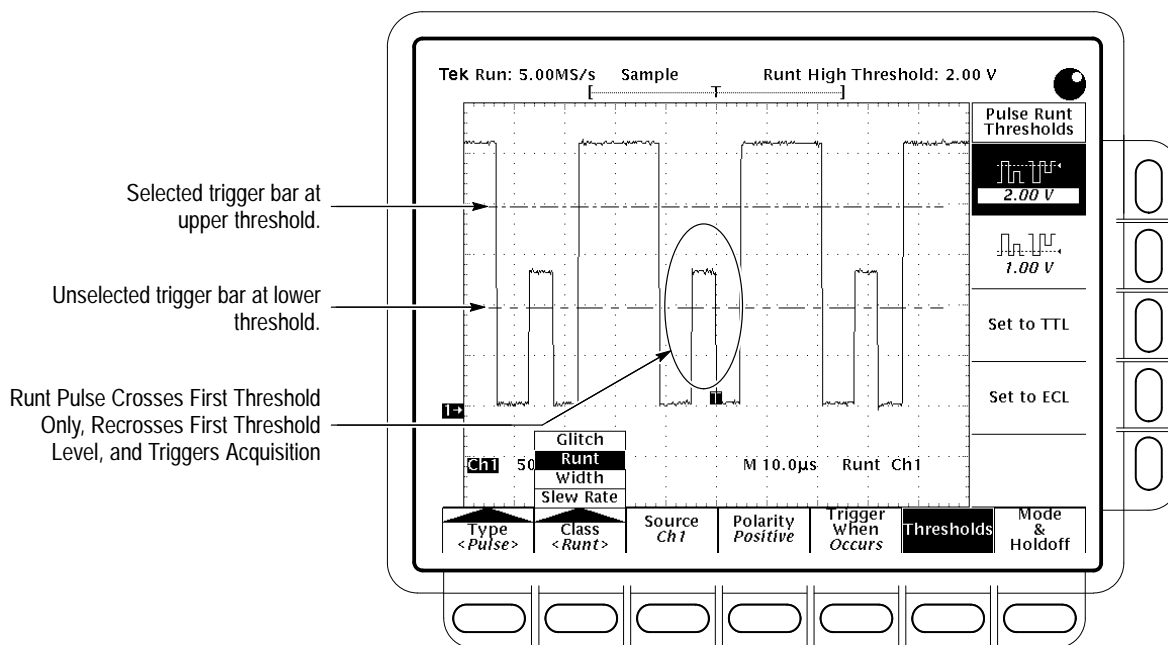

Figure 3-45: Main Trigger Menu — Runt Class

Set the Thresholds. To set the two threshold levels used in detecting a runt pulse:

1. Press **TRIGGER MENU** → **Type** (main) → **Pulse** (pop-up) → **Class** (main) → **Runt** (pop-up) → **Thresholds** (main).
2. Use the general purpose knob or keypad to set the values for the high and low thresholds.

Hint: To use the Trigger Bar feature to set the threshold levels on the pulse train, press **DISPLAY** → **Readout Options** (main) → **Trigger Bar Style** (side) until **Long** appears in that menu item.

Note the position of the trigger indicator in Figure 3–45 on page 3–75. Triggering occurs at the point the pulse returns over the first (lower) threshold going negative without crossing the second threshold level (upper). The polarity selected in the Polarity side menu determines the order that the threshold must be crossed for a runt trigger to occur:

Positive requires that the *lower* threshold must be first crossed going *positive*, then recrossed going *negative* without the *upper* threshold being crossed at all.

Negative requires that the *upper* threshold must be first crossed going *negative*, then recrossed going *positive* without the *lower* threshold being crossed at all.

Either requires only that either *one* of the thresholds must be first crossed going in *either* direction, then recrossed going in the *opposite* direction without the *other* threshold being crossed at all.

For all three polarity settings, triggering occurs at the point the runt pulse *recrosses* its first threshold.

Set the Mode and Holdoff. Mode and holdoff can be set for all standard trigger types and classes. To set mode and holdoff, refer to *Set Mode & Holdoff* on page 3–59. To learn more about trigger mode and holdoff, see *Trigger Modes* and *Trigger Holdoff* on page 3–51.

Trigger Based on Pulse Width

When you select the pulse class **Width**, the oscilloscope will trigger on a pulse narrower (or wider) than some specified *range* of time (defined by the upper limit and lower limit). To set up for width triggering, do the following procedures.

Select Width Triggering. Press **TRIGGER MENU** → **Type** (main) → **Pulse** (pop-up) → **Class** (main) → **Width** (pop-up).

Select the Source. Press **TRIGGER MENU** → **Type** (main) → **Pulse** (pop-up) → **Source** (main) → **Ch1**, **Ch2**, **Ch3**, or **Ch4** (side). The source selected becomes the trigger source for all four trigger classes.

Select the Polarity. Press **TRIGGER MENU** → **Type** (main) → **Pulse** (pop-up) → **Class** (main) → **Width** (pop-up) → **Polarity** (main) → **Positive** or **Negative** (side).

Set to Trig When. To set the range of widths (in units of time) the trigger source will search for and to specify whether to trigger on pulses that are outside this range or within this range, do the following steps:

1. Press **TRIGGER MENU** → **Type** (main) → **Pulse** (pop-up) → **Class** (main) → **Width** (pop-up) → **Trig When** (main).
2. Press **Within Limits** (side) if you want the oscilloscope to trigger on pulses that fall within the specified range. If you want it to trigger on pulses that are outside the range, then press **Out of Limits** (side).
3. To set the range of pulse widths in units of time, press **Upper Limit** (side) and **Lower Limit** (side). Enter the values with the general purpose knob or keypad. The **Upper Limit** is the maximum valid pulse width the trigger source will look for. The **Lower Limit** is the minimum valid pulse width. The oscilloscope will always force the **Lower Limit** to be less than or equal to the **Upper Limit**.

Set the Level. Press **TRIGGER MENU** → **Type** (main) → **Pulse** (pop-up) → **Class** (main) → **Width** (pop-up) → **Level** (main) → **Level, Set to TTL, Set to ECL, or Set to 50%** (side).

Set the Mode and Holdoff. Mode and holdoff can be set for all standard trigger types and classes. To set mode and holdoff, refer to *Set Mode & Holdoff* on page 3–59. To learn more about trigger mode and holdoff, see *Trigger Modes* and *Trigger Holdoff* on page 3–51.

To Trigger Based on Slew Rate

When you select the pulse class Slew Rate, the oscilloscope will trigger on a pulse edge that traverses between an upper and lower threshold faster or slower than a slew rate you specify. To set up for slew rate triggering, do the following procedures.

Select Slew Rate Triggering. Press **TRIGGER MENU** → **Type** (main) → **Pulse** (pop-up) → **Class** (main) → **Slew Rate** (pop-up). (See Figure 3–46 on page 3–79.)

Select the Source. Press **TRIGGER MENU** → **Type** (main) → **Pulse** (pop-up) → **Source** (main) → **Ch1, Ch2, Ch3, or Ch4** (side). The source selected becomes the trigger source for all four trigger classes.

Select Polarity. To specify the direction of the pulse edge, press **TRIGGER MENU** → **Type** (main) → **Pulse** (pop-up) → **Class** (main) → **Slew Rate** (pop-up) → **Polarity** (main) → **Positive, Negative, or Either** (side).

Positive monitors the slew rate of the positive-going edges of pulses. The edge must first cross the lower threshold and then cross the upper threshold.

Negative monitors the slew rate of the negative-going edges of pulses. The edge must first cross the upper threshold and then cross the lower threshold.

Either monitors positive- and negative-going edges of pulses. The edge may first cross either threshold and then cross the other.

Set the Slew Rate. The threshold levels and the delta time setting determine the slew rate setting. To set these parameters:

1. Press **TRIGGER MENU** → **Type** (main) → **Pulse** (pop-up) → **Class** (main) → **Slew Rate** (pop-up) → **Thresholds** (main).
2. Press **Set to TTL** or **Set to ECL** (side) to set the upper and lower thresholds to levels appropriate for those to logic families. ...*OR*...
3. Press the upper threshold button and, in turn, lower threshold button (side) Use the general purpose knob or keypad to set the values for the high and low thresholds.

Hint: To use the Trigger Bar feature to set the threshold levels on the pulse edge, press **DISPLAY** → **Readout Options** (main) → **Trigger Bar Style** (side) until **Long** appears in that menu item.

The threshold settings determine the voltage component of slew rate (Volts/Second). To finish specifying the slew rate, set the time component by doing the following steps:

4. Press **TRIGGER MENU** → **Type** (main) → **Pulse** (pop-up) → **Class** (main) → **Slew Rate** (pop-up) → **Trigger When** (main) → **Delta Time** (side).
5. Use the general purpose knob or keypad to set the delta time value for slew rate.

NOTE. *The menu item Slew Rate in the side menu is not a button label; rather it is a readout of the slew rate setting. This readout varies as you vary the Delta Time setting this side menu and as you vary either of the threshold settings from the Thresholds menu. You adjust those parameters to adjust slew rate; you can't adjust slew rate directly.*

Set to Trig When. The oscilloscope compares the pulse edge of the trigger source against the slew rate setting read out in the Trigger When menu. To select

whether to trigger on edges with slew rates faster than or slower than that indicated in readout, do the following step:

Press **TRIGGER MENU** → **Type** (main) → **Pulse** (pop-up) → **Class** (main) → **Slew Rate** (pop-up) → **Trigger When** (main) → **Trigger if Faster Than** or **Trigger if Slower Than** (side). (See Figure 3–46.)

NOTE. If you select **Trigger if Faster Than** and the oscilloscope does not trigger, it may be because the pulse edge is too fast rather than too slow. To check the edge speed, switch to edge triggering. Then trigger on the pulse edge and determine the time the edge takes to travel between the levels set in the slew rate Thresholds menu. The oscilloscope cannot slew rate trigger on pulse edges that traverse between threshold levels in 600 ps or less.

Also, to reliably slew rate trigger, a pulse must have a width of 7.5 ns or more. A pulse of less width may trigger on the wrong slope or not trigger at all. Switch to edge triggering and check the pulse width if you can't slew rate trigger as expected.

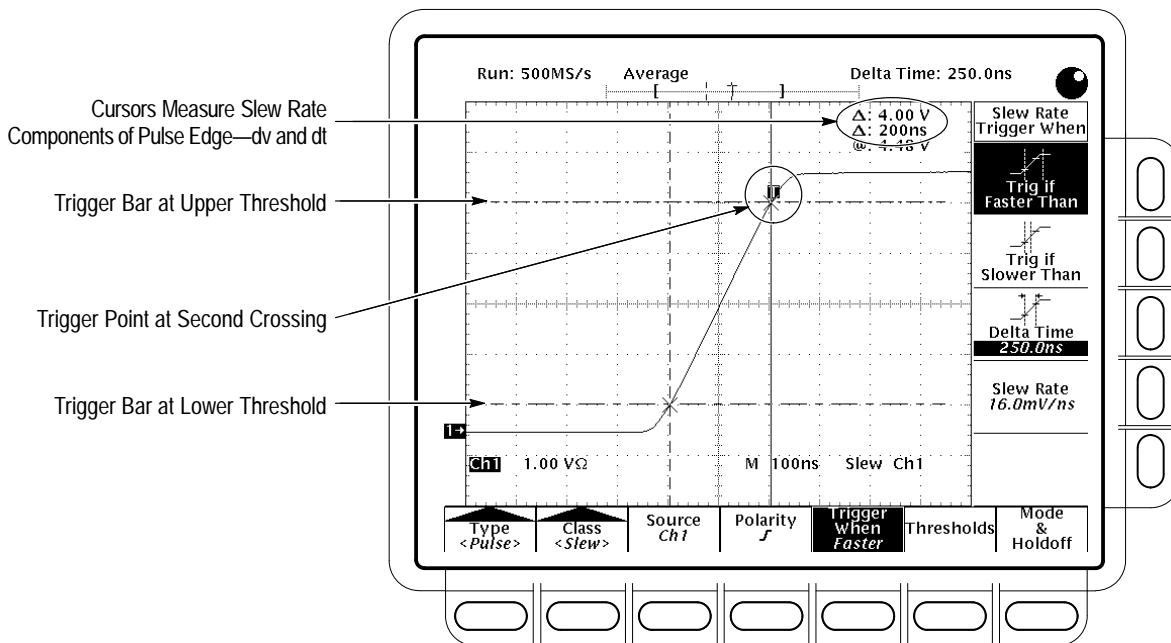

Figure 3–46: Main Trigger Menu — Slew Rate Class

To understand what happens when you slew rate trigger, study Figure 3–46 as you consider the following points:

- The main menu shows the oscilloscope is set to trigger based on the slew rate of a pulse input to the trigger source, Ch 1. It is set to monitor the positive-polarity pulse edges of the trigger source and to trigger on any edge with a slew rate faster than the slew rate setting.
- The Trigger When side menu displays the readout *Slew Rate* that indicates the slew rate setting. The slew rate setting is *not* the slew rate of the pulse; instead, it is the slew rate against which the oscilloscope *compares* the slew rate of pulse (see above). You set the slew rate setting indirectly by setting the ratio of delta voltage to delta time as:

$$\text{Slew Rate Setting} = \frac{\text{Upper Threshold Setting} - \text{Lower Threshold Setting}}{\text{Delta Time Setting}}$$

Substituting the threshold and delta time settings for the setup in Figure 3–46:

$$\text{Slew Rate Setting} = \frac{4.5 \text{ V} - 0.5 \text{ V}}{250 \text{ ns}} = 16.0 \text{ mV/ns}$$

- The trigger bar indicators (long horizontal bars) point to the upper and lower thresholds. The pair cursors, which are aligned to threshold levels, read out a delta voltage of approximately 4 V and a delta time of 200 ns between the threshold levels. Therefore, the slew rate of the pulse edge triggered on is:

$$\text{Slew Rate Measured} = \frac{dv}{dt} = \frac{4 \text{ Volts}}{200 \text{ ns}} = 20 \text{ mV/ns}$$

- The Trigger When side menu indicates the oscilloscope will trigger on pulses with slew rates slower than the slew rate setting. Since the pulse edge slews at 20 mV/ns, which is faster than the slew rate setting of 16 mV/ns, the oscilloscope triggers.
- The trigger point indicator shows where the oscilloscope triggers. For a slew rate triggered waveform, the trigger point is always at the threshold crossed last (the upper threshold for positive polarity settings; the lower for negative settings).

Set the Mode and Holdoff. Mode and holdoff can be set for all standard trigger types and classes. To set mode and holdoff, refer to *Set Mode & Holdoff* on page 3–59. To learn more about trigger mode and holdoff, see *Trigger Modes* and *Trigger Holdoff* on page 3–51.

Delayed Triggering

The TDS Oscilloscope provides a main time base and a delayed time base. The delayed time base, like the main time base, requires a trigger signal and an input source dedicated to that signal. You can only use delay with respect to the main

edge trigger and certain classes of main pulse triggers. This subsection describes how to delay the acquisition of waveforms. (The Delayed time base is not available in InstaVu mode (TDS 700A models only); see *Incompatible Modes* on page 3–45.)

There are two different ways to delay the acquisition of waveforms: *delayed runs after main* and *delayed triggerable*. Only delayed triggerable uses the delayed trigger system. *Delayed runs after main* looks for a main trigger, then waits a user-defined time, and then starts acquiring. (See Figure 3–47.)



Figure 3–47: Delayed Runs After Main

Delayed triggerable looks for a main trigger and then, depending on the type of delayed trigger selected, makes one of the three types of delayed triggerable mode acquisitions: *After Time*, *After Events*, or *After Events/Time*. Study Figure 3–48 to understand the sequence the oscilloscope goes through for each delayed mode.

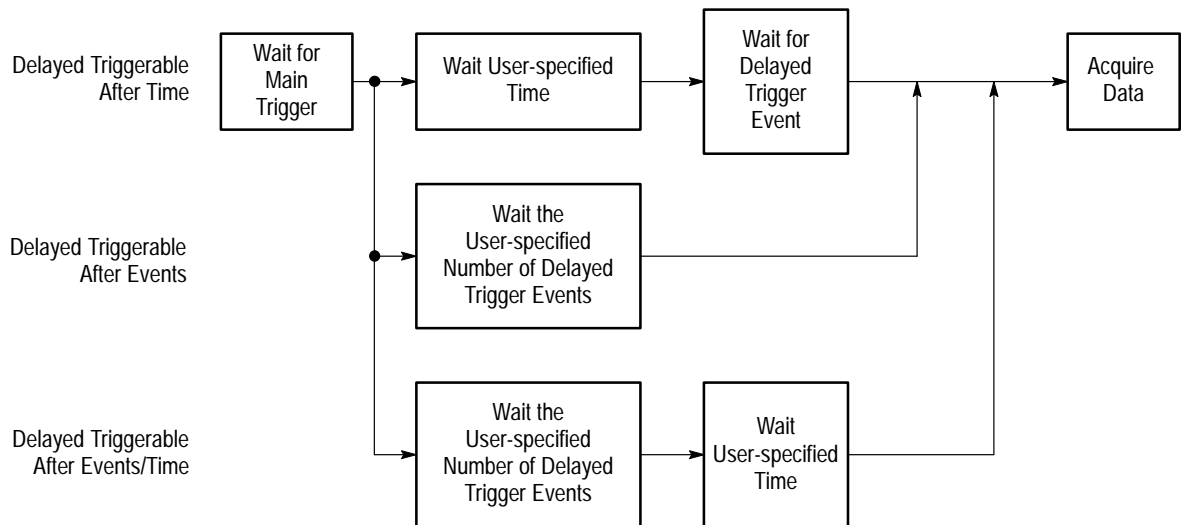

Figure 3–48: Delayed Triggerable

The oscilloscope is always acquiring samples to fill the pretrigger part of the waveform record. When and if delay criteria are met, it takes enough posttrigger samples to complete the delayed waveform record and then displays it. Refer to Figure 3–49 for a more detailed look at how delayed records are placed in time relative to the main trigger.

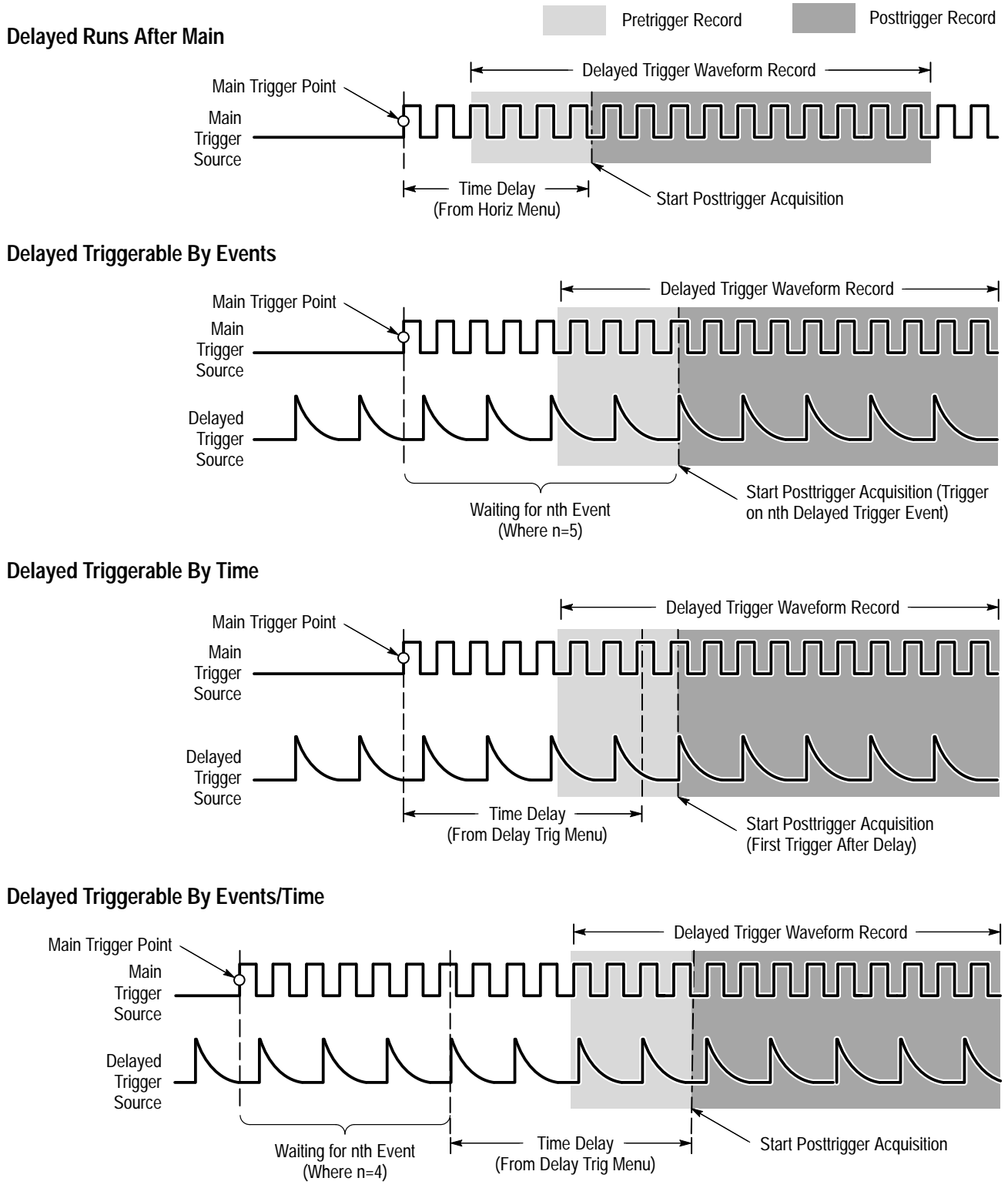

Figure 3-49: How the Delayed Triggers Work

NOTE. Due to hardware limitations, the delayed time base cannot be made triggerable when the main trigger type is Logic, any class, or when the main trigger type is Pulse with Runt or Slew Rate classes selected. For these settings, the oscilloscope will force the delayed time base to be in Runs After mode.

To Run After Delay

You use the Horizontal menu to select and define either delayed runs after main or delayed triggerable. Delayed triggerable, however, requires further selections in the Delayed Trigger menu. Do the following steps to set the delayed time base to run immediately after delay:

1. Press **HORIZONTAL MENU** → **Time Base** (main) → **Delayed Only** (side) → **Delayed Runs After Main** (side).
2. Use the general purpose knob or the keypad to set the delay time.

If you press Intensified (side), you display an intensified zone on the main timebase record that shows where the delayed timebase record occurs relative to the main trigger. For Delayed Runs After Main mode, the start of the intensified zone corresponds to the start of the delayed timebase record. The end of the zone corresponds to the end of the delayed record.

To Trigger After Delay

To make sure that the Main Trigger menu settings are compatible with Delayed Triggerable and to select that mode, do the following steps:

1. Press **TRIGGER MENU**.
2. If **Type** is set to **Logic**, press **Type** (main) to change it to either **Edge** or **Pulse** as fits your application. Logic type is incompatible with Delayed Triggerable.
3. If **Source** is set to **Auxiliary**, press **Source** (main). Select any source other than Auxiliary from the side menu according to your application.
4. If **Type** is set to **Pulse**, press **Class** (main) and change it to either **Glitch** or **Width** as fits your application. Runt and Slew Rate pulse classes are incompatible with Delayed Triggerable.
5. Press **HORIZONTAL MENU** → **Time Base** (main) → **Delayed Only** (side) → **Delayed Triggerable** (side).

NOTE. The Delayed Triggerable menu item is not selectable unless incompatible Main Trigger menu settings are eliminated. (See the steps at the beginning of this procedure.) If such is the case, the Delayed Triggerable menu item is dimmer than other items in the menu.

By pressing Intensified (side), you can display an intensified zone that shows where the delayed timebase record *may* occur (a valid delay trigger event must be received) relative to the main trigger on the main time base. For Delayed Triggerable After mode, the start of the intensified zone corresponds to the possible start point of the delayed time base record. The end of the zone continues to the end of main time base, since a delayed time base record may be triggered at any point after the delay time elapses.

To learn how to define the intensity level of the normal and intensified waveform, see *Adjust Intensity* on page 3–29.

Now you need to bring up the Delayed Trigger menu so that you can define the delayed trigger event.

6. Press **SHIFT DELAYED TRIG** → **Delay by** (main) → **Triggerable After Time, Events, or Events/Time** (side) (See Figure 3–50.)

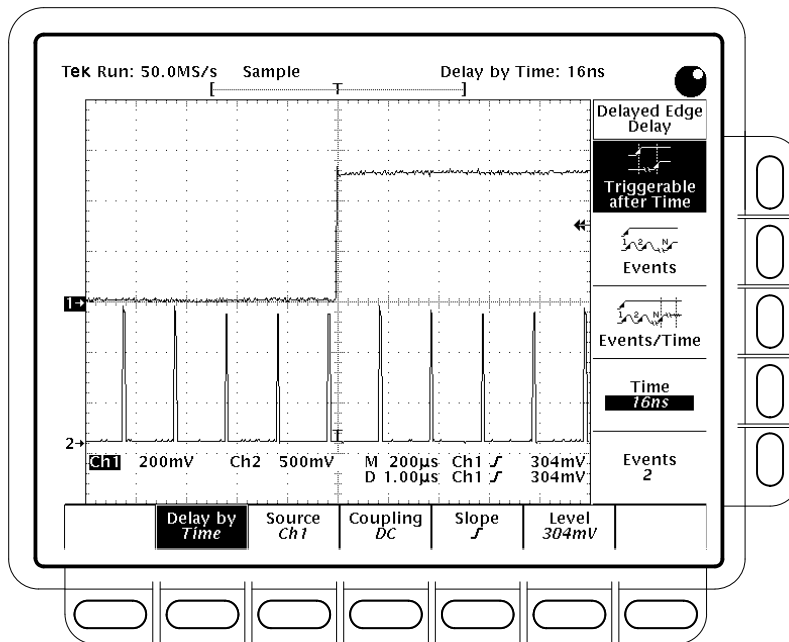

Figure 3–50: Delayed Trigger Menu

7. Enter the delay time or events using the general purpose knob or the keypad. If you selected **Events/Time**, use **Time** (side) and **Events** (side) to switch between setting the time and the number of events.

Hint: You can go directly to the Delayed Trigger menu. (See step 6.) By selecting one of Triggerable After Time, Events, or Events/Time, the oscilloscope automatically switches to Delayed Triggerable in the Horizontal

menu. You will still need to display the Horizontal menu if you wish to leave Delayed Triggerable.

The **Source** menu lets you select which input will be the delayed trigger source.

8. Press **Source** (main) → **Ch1, Ch2, Ch3, Ch4**, or **DC Aux** (side).

NOTE. *Selecting DC Aux as source in BOTH the main and delayed triggering menus forces main and delayed trigger levels to adjust in tandem. As long as their source remain DC Aux, adjusting the trigger level for either system adjusts it for both systems.*

9. Press **Coupling** (main) → **Main Trigger, DC**, or **Noise Rej** (side) to define how the input signal will be coupled to the delayed trigger.

Main Trigger sets delayed trigger coupling to match the main trigger coupling setting. For descriptions of the **DC** and **Noise Rej** coupling types, see *To Specify Coupling* on page 3–58.

10. Press **Slope** (main) to select the slope that the delayed trigger will occur on. Choose between the rising edge and falling edge slopes.

When using Delayed Triggerable mode to acquire waveforms, two trigger bars are displayed. One trigger bar indicates the level set by the main trigger system; the other indicates the level set by the delayed trigger system.

11. Press **Level** (main) → **Level, Set to TTL, Set to ECL**, or **Set to 50%** (side).

Level lets you enter the delayed trigger level using the general purpose knob or the keypad.

Set to TTL fixes the trigger level at +1.4 V.

Set to ECL fixes the trigger level at –1.3 V.

Set to 50% fixes the delayed trigger level to 50% of the peak-to-peak value of the delayed trigger source signal.

NOTE. *When you set the Vertical SCALE smaller than 200 mV, the oscilloscope reduces the Set to TTL or Set to ECL trigger levels below standard TTL and ECL levels. That happens because the trigger level range is fixed at ± 12 divisions from the center. At 100 mV (the next smaller setting after 200 mV) the trigger range is ± 1.2 V which is smaller than the typical TTL (+1.4 V) or ECL (–1.3 V) level.*

Measuring Waveforms

To make the best use of the TDS Oscilloscope when taking measurements, you need to know how to use the three types, or *classes*, of measurements it can take. This section describes how to take the following classes of measurements (Figure 3–51 shows all three measurement classes):

- *Automated* for automatically taking and displaying waveform measurements
- *Cursor* for measuring the difference (either in time or voltage) between two locations in a waveform record
- *Graticule* for making quick estimates by counting graticule divisions on screens

This section also tells you how to use *Probe Cal* and *Signal Path Compensation* to optimize the accuracy of your measurements.

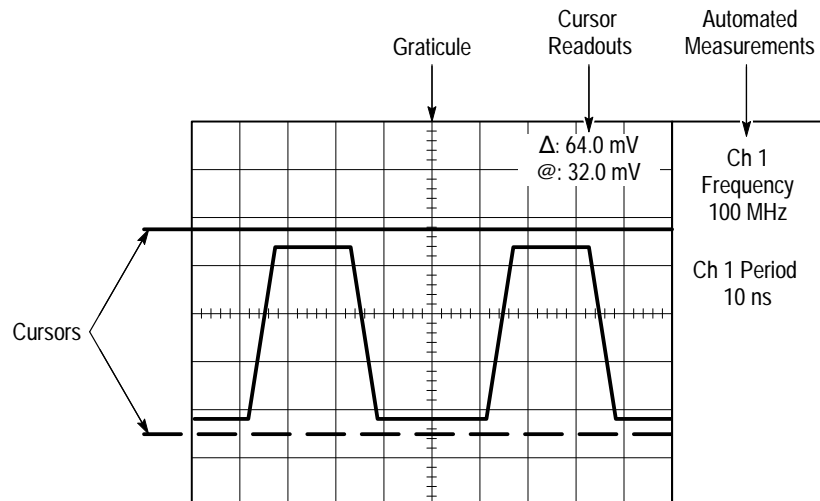

Figure 3–51: Graticule, Cursor and Automated Measurements

Taking Automated Measurements

The TDS Oscilloscope provides the feature *Measure* for automatically taking and displaying waveform measurements. This subsection describes how to set up the oscilloscope to let it do the work of taking measurements for you.

Because automatic measurements use the waveform record points, they are generally more accurate and quicker than cursor and graticule measurements. The oscilloscope will continuously update and display these measurements.

Automatic measurements are taken over the entire waveform record or, if you specify gated measurements (see page 3–91), over the region specified by the vertical cursors. Automated measurements are not taken just on the displayed portions of waveforms.

The oscilloscope can also display almost all of the measurements at once — see *Take a Snapshot of Measurements* on page 3–95.

Measurement List

The TDS Oscilloscope provides you with 25 automatic measurements in three categories: *amplitude* (typically in volts; sometimes in %), *time* (typically in seconds or hertz), and *area* (in volt-seconds). Table 3–9 lists brief definitions of the automated measurements in the oscilloscope (for more details see *Appendix B: Algorithms*, page B–1).

Table 3–9: Measurement Definitions

























Name	Definition
 Amplitude	Voltage measurement. The high value less the low value measured over the entire waveform or gated region. <i>Amplitude = High – Low</i>
 Area	Voltage over time measurement. The area over the entire waveform or gated region in volt-seconds. Area measured above ground is positive; area below ground is negative.
 Cycle Area	Voltage over time measurement. The area over the first cycle in the waveform, or the first cycle in the gated region, in volt-seconds. Area measured above ground is positive; area below ground is negative.
 Burst Width	Timing measurement. The duration of a burst. Measured over the entire waveform or gated region.
 Cycle Mean	Voltage measurement. The arithmetic mean over the first cycle in the waveform or the first cycle in the gated region.
 Cycle RMS	Voltage measurement. The true Root Mean Square voltage over the first cycle in the waveform or the first cycle in the gated region.
 Delay	Timing measurement. The time between the MidRef crossings of two different traces or the gated region of the traces.
 Fall Time	Timing measurement. Time taken for the falling edge of the first pulse in the waveform or gated region to fall from a High Ref value (default = 90%) to a Low Ref value (default = 10%) of its final value.
 Frequency	Timing measurement for the first cycle in the waveform or gated region. The reciprocal of the period. Measured in Hertz (Hz) where 1 Hz = 1 cycle per second.
 High	The value used as 100% whenever High Ref, Mid Ref, and Low Ref values are needed (as in fall time and rise time measurements). Calculated using either the min/max or the histogram method. The <i>min/max</i> method uses the maximum value found. The <i>histogram</i> method uses the most common value found above the mid point. Measured over the entire waveform or gated region.

Table 3-9: Measurement Definitions (Cont.)

Name	Definition
 Low	The value used as 0% whenever High Ref, Mid Ref, and Low Ref values are needed (as in fall time and rise time measurements). May be calculated using either the min/max or the histogram method. With the min/max method it is the minimum value found. With the histogram method, it refers to the most common value found below the midpoint. Measured over the entire waveform or gated region.
 Maximum	Voltage measurement. The maximum amplitude. Typically the most positive peak voltage. Measured over the entire waveform or gated region.
 Mean	Voltage measurement. The arithmetic mean over the entire waveform or gated region.
 Minimum	Voltage measurement. The minimum amplitude. Typically the most negative peak voltage. Measured over the entire waveform or gated region.
 Negative Duty Cycle	Timing measurement of the first cycle in the waveform or gated region. The ratio of the negative pulse width to the signal period expressed as a percentage. $\text{NegativeDutyCycle} = \frac{\text{NegativeWidth}}{\text{Period}} \times 100\%$
 Negative Overshoot	Voltage measurement. Measured over the entire waveform or gated region. $\text{NegativeOvershoot} = \frac{\text{Low} - \text{Min}}{\text{Amplitude}} \times 100\%$
 Negative Width	Timing measurement of the first pulse in the waveform or gated region. The distance (time) between MidRef (default 50%) amplitude points of a negative pulse.
 Peak to Peak	Voltage measurement. The absolute difference between the maximum and minimum amplitude in the entire waveform or gated region.
 Phase	Timing measurement. The amount one waveform leads or lags another in time. Expressed in degrees, where 360° comprise one waveform cycle.
 Period	Timing measurement. Time it takes for the first complete signal cycle to happen in the waveform or gated region. The reciprocal of frequency. Measured in seconds.
 Positive Duty Cycle	Timing measurement of the first cycle in the waveform or gated region. The ratio of the positive pulse width to the signal period expressed as a percentage. $\text{PositiveDutyCycle} = \frac{\text{PositiveWidth}}{\text{Period}} \times 100\%$
 Positive Overshoot	Voltage measurement over the entire waveform or gated region. $\text{PositiveOvershoot} = \frac{\text{Max} - \text{High}}{\text{Amplitude}} \times 100\%$
 Positive Width	Timing measurement of the first pulse in the waveform or gated region. The distance (time) between MidRef (default 50%) amplitude points of a positive pulse.
 Rise time	Timing measurement. Time taken for the leading edge of the first pulse in the waveform or gated region to rise from a Low Ref value (default = 10%) to a High Ref value (default = 90%) of its final value.
 RMS	Voltage measurement. The true Root Mean Square voltage over the entire waveform or gated region.

Measurement Readouts

With no menus displayed, the measurement readouts appear far right of the display graticule. (See Figure 3–52.) You can display and continuously update as many as four measurements at any one time. With any menu displayed, the readouts move to the right side of the graticule area.

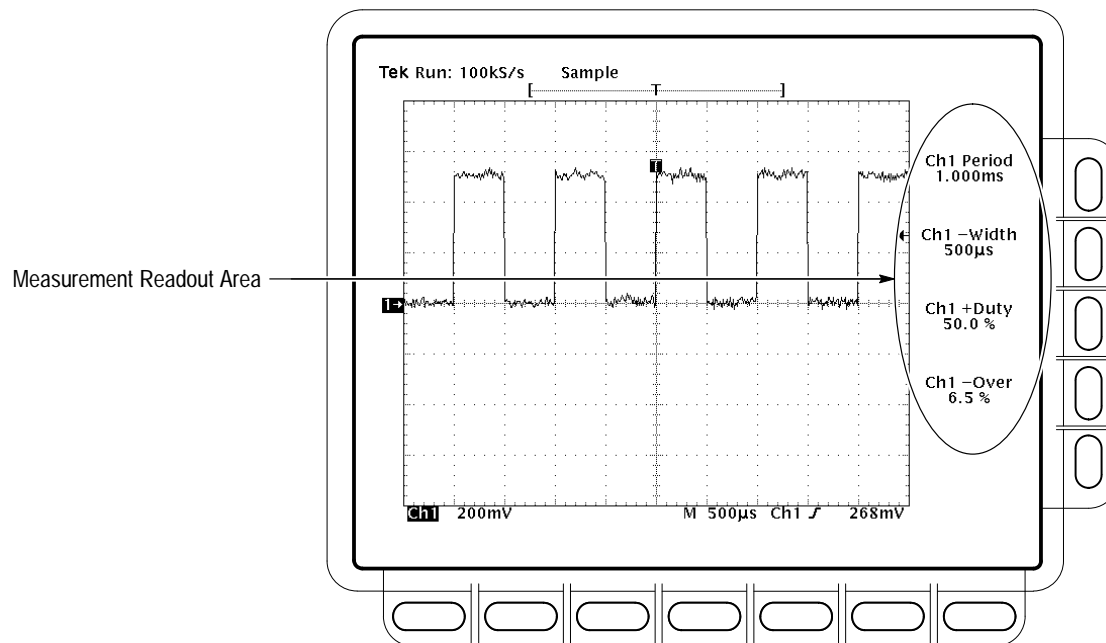

Figure 3–52: Measurement Readouts

Measurement 1 is the top readout. Measurement 2 is below it, and so forth. Once a measurement readout is displayed in the screen area, it stays in its position even when you remove any measurement readouts above it.

Display Measurements

To use the automatic measurements you first need to obtain a stable display of the waveform to be measured. (Pressing **AUTOSET** may help.) Once you have a stable display, press **MEASURE** to bring up the Measure menu. (See Figure 3–53.)

1. Press **MEASURE** → **Select Measrmnt** (main).
2. Select a measurement from the side menu. Note the following rules for taking automatic measurements:
 - You can only take a maximum of four measurements at a time. To add a fifth, you must remove one or more of the existing measurements.
 - To vary the source for measurements, simply select the other channel and then choose the measurements you want.

- Be careful when taking automatic measurements on noisy signals. You might measure the frequency of the noise and not the desired waveform. Your oscilloscope helps identify such situations by displaying a *low signal amplitude* or *low resolution* warning message.

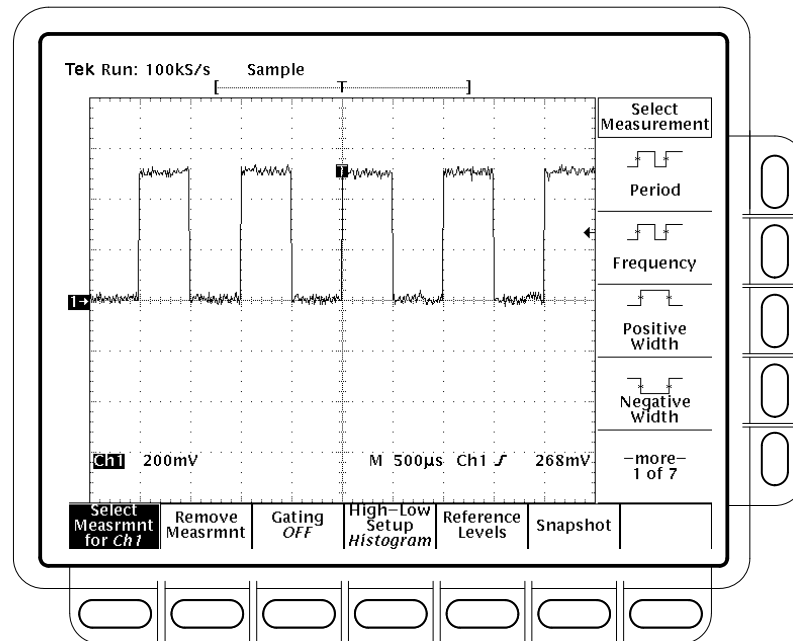

Figure 3-53: Measure Menu

Remove Measurements

The **Remove Measrmt** selection provides explicit choices for removing measurements from the display according to their readout position. To remove measurements, do the following steps:

1. Press **MEASURE** → **Remove Measrmt** (main).
2. Select the measurement to remove from the side menu. If you want to remove all the measurements at one time, press **All Measurements** (side).

Gate Measurements

The gating feature lets you limit measurements to a specified portion of the waveform. When gating is **Off**, the oscilloscope makes measurements over the entire waveform record.

When gating is activated, vertical cursors are displayed. Use these cursors to define the section of the waveform you want the oscilloscope to measure. (This section is called the *gated region*.) Do the following steps to gate a measurement:

1. Press **MEASURE** → **Gating** (main) → **Gate with V Bar Cursors** (side). (See Figure 3-54.)

- Using the general purpose knob, move the selected (the active) cursor. Press **SELECT** to change which cursor is active.

Displaying the cursor menu and turning V Bar cursors off will *not* turn gating off. (Gating arrows remain on screen to indicate the area over which the measurement is gated.) You must turn gating off in the Gating side menu.

NOTE. *Cursors are displayed relative to the selected waveform. If you are making a measurement using two waveforms, this behavior can be a source of confusion. If you turn off horizontal locking and adjust the horizontal position of one waveform independent of the other, the cursors appear at the requested position with respect to the selected waveform. Gated measurements remain accurate, but the displayed positions of the cursors change when you change the selected waveform.*

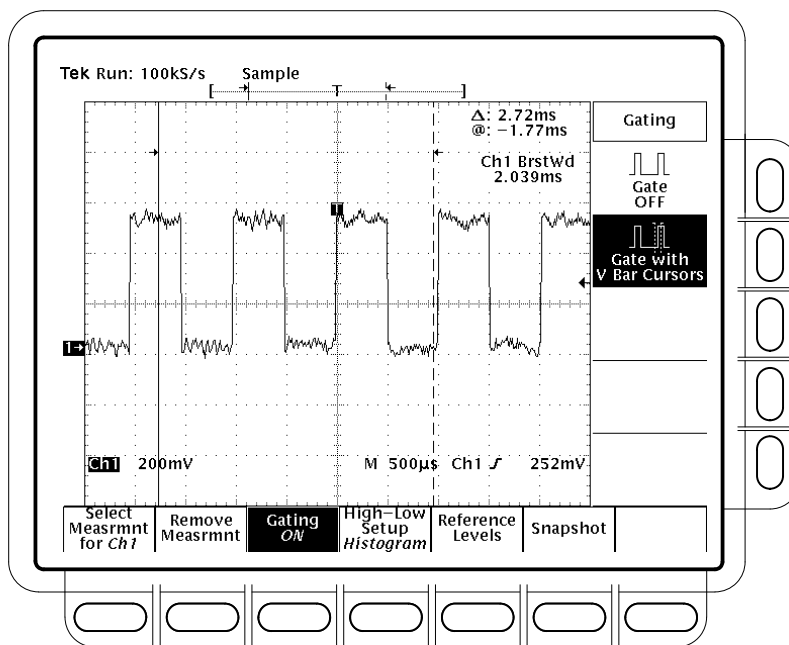

Figure 3-54: Measure Menu — Gating

Define High-Low Setup

The oscilloscope provides two settings, *histogram* and *min-max*, for specifying how measure determines the High and Low levels of waveforms. To use the high-low setup do the following step:

Press **MEASURE** → **High-Low Setup** (main) → **Histogram** or **Min-Max** (side). If you select **Min-Max**, you may also want to check and/or revise values using the Reference Levels main menu.

Histogram sets the values statistically. It selects the most common value either above or below the midpoint (depending on whether it is defining the high or low reference level). Since this statistical approach ignores short term aberrations (overshoot, ringing, etc.), histogram is the best setting for examining pulses.

Min-max uses the highest and lowest values of the waveform record. This setting is best for examining waveforms that have no large, flat portions at a common value, such as sine waves and triangle waves — almost any waveform except for pulses.

Define Reference Levels

Once you define the reference levels, the oscilloscope will use them for all measurements requiring those levels. To set the reference levels, do the following steps:

1. Press **MEASURE** → **Reference Levels** (main) → **Set Levels** (side) to choose whether the References are set in % relative to High (100%) and Low (0%) or set explicitly in the units of the selected waveform (typically volts). See Figure 3–55. Use the general purpose knob or keypad to enter the values.

% is the default selection. It is useful for general purpose applications.

Units helps you set precise values. For example, if your are measuring specifications on an RS-232-C circuit, set the levels precisely to RS-232-C specification voltage values by defining the high and low references in units.

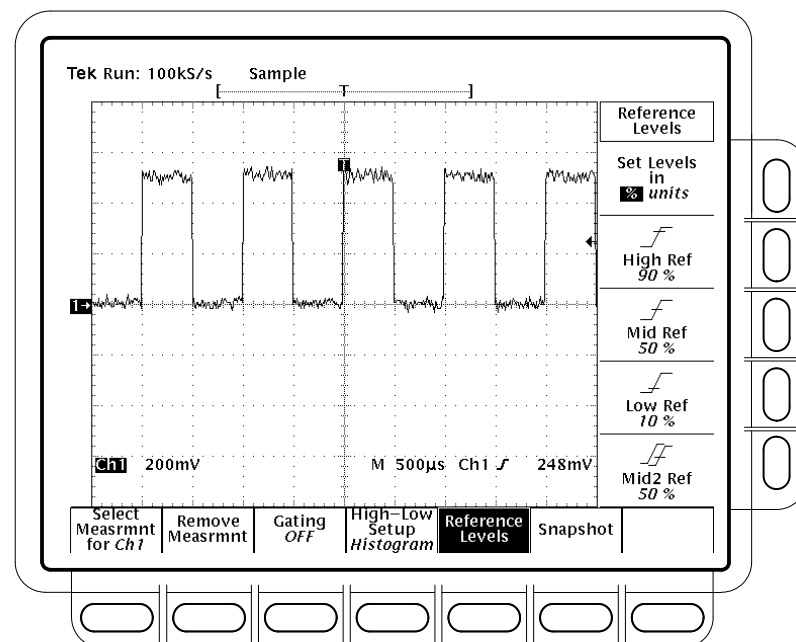

Figure 3–55: Measure Menu — Reference Levels

2. Press **High Ref**, **Mid Ref**, **Low Ref**, or **Mid2 Ref** (side).



High Ref — Sets the high reference level. The default is 90%.



Mid Ref — Sets the middle reference level. The default is 50%.



Low Ref — Sets the low reference level. The default is 10%.



Mid2 Ref — Sets the middle reference level used on the second waveform specified in the Delay or Phase Measurements. The default is 50%.

Take a Delay Measurement

The delay measurement lets you measure from an edge on the selected waveform to an edge on another waveform. To take a delay measurement, do the following steps:

1. Press **MEASURE** → **Select Measmnt** (main) → **Delay** (side) → **Delay To** (main) → **Measure Delay to**.
2. Press **Measure Delay to** (side) repeatedly to choose the delay *to* waveform. The choices are **Ch1**, **Ch2**, **Ch3**, **Ch4**, **Math1**, **Math2**, **Math3**, **Ref1**, **Ref2**, **Ref3**, and **Ref4**.

The steps just performed select the waveform you want to measure *to*; note that the waveform you are measuring delay *from* is the selected waveform. (See Figure 3–56.)

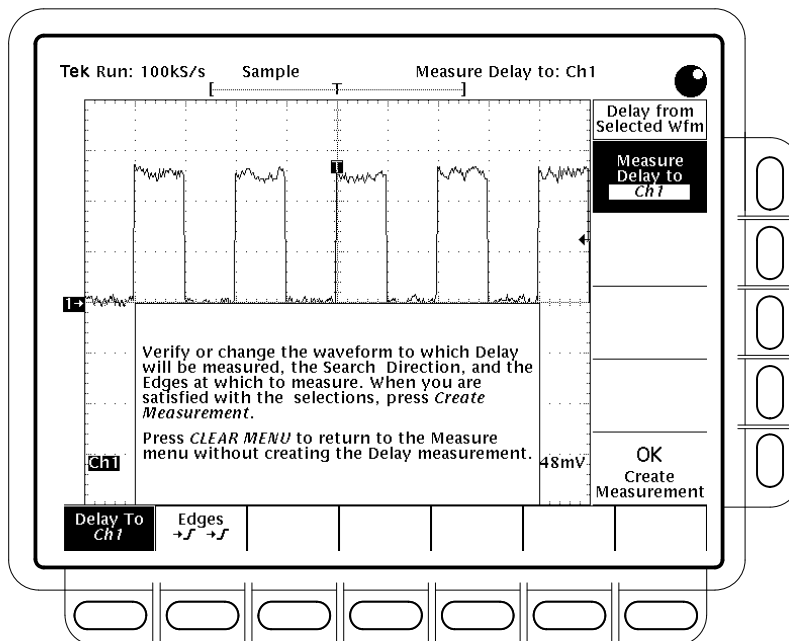

Figure 3–56: Measure Delay Menu — Delay To

3. Press **MEASURE** → **Select Measrmt** (main) → **Delay** (side) → **Edges** (main). A side menu of delay edges and directions will appear. Choose from one of the combinations displayed on the side menu using the following information:
 - The selection you choose defines which edges you want the delayed measurement to be made between.
 - The upper waveform on each icon represents the *from* waveform and the lower one represents the *to* waveform.
 - The direction arrows on the choices let you specify a forward search on both waveforms or a forward search on the *from* waveform and a backwards search on the *to* waveform. The latter choice is useful for isolating a specific pair of edges out of a stream.
4. To take the measurement you just specified, press **Delay To** (main) → **OK Create Measurement** (side).

To exit the Measure Delay menu rather than creating a delay measurement, press **CLEAR MENU**, which returns you to the Measure menu.

Take a Snapshot of Measurements

Sometimes you may want to see all of the automated measurements on screen at the same time. To do so, use Snapshot. Snapshot executes all of the single waveform measurements available on the selected waveform *once* and displays the results. (The measurements are not continuously updated.) All of the measurements listed in Table 3–9 on page 3–88 except for Delay and Phase are displayed. (Delay and Phase are dual waveform measurements and are not available with Snapshot.)

The readout area for a snapshot of measurements is a pop-up display that covers about 80% of the graticule area when displayed. (See Figure 3–57.) You can display a snapshot on any channel or ref memory, but only one snapshot can be displayed at a time.

To use Snapshot, obtain a stable display of the waveform to be measured (pressing **AUTOSET** may help). Then do the following steps:

1. Press **MEASURE** → **SNAPSHOT** (main).
2. Press either **SNAPSHOT** (main) or **AGAIN** (side) to take another snapshot.

NOTE. *The Snapshot display tells you the channel that the snapshot is being made on.*

3. Push **Remove Measrmt**.

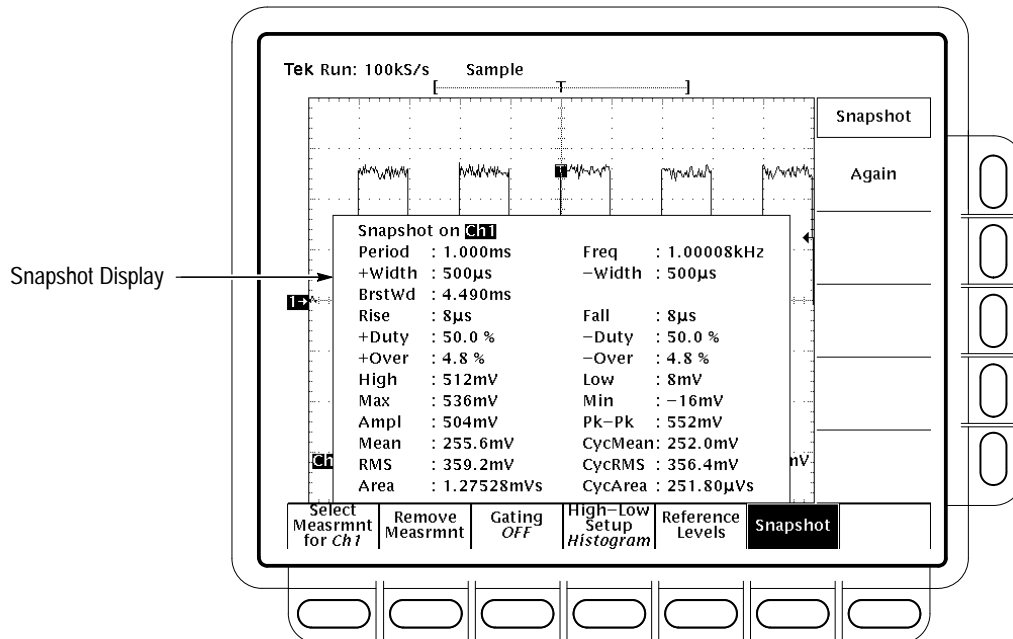

Figure 3-57: Snapshot Menu and Readout

Consider the following rules when taking a snapshot:

- Be sure to display the waveform properly before taking a snapshot. Snapshot does not warn you if a waveform is improperly scaled (clipped, low signal amplitude, low resolution, etc.).
- To vary the source for taking a snapshot, simply select another channel, math, or ref memory waveform and then execute snapshot again.
- Note that a snapshot is taken on a single waveform acquisition (or acquisition sequence). The measurements in the snapshot display are not continuously updated.
- Be careful when taking automatic measurements on noisy signals. You might measure the frequency of the noise and not the desired waveform.
- Note that pushing any button in the main menu (except for Snapshot) or any front panel button that displays a new menu removes the snapshot from display.
- Use High-Low Setup (page 3-92), Reference Levels (page 3-93), and Gated Measurements (page 3-91) with Snapshot exactly as you would when you display individual measurements from the **Select Measrmt** menu.

To Find More Information

To perform a tutorial that shows you how to take automatic measurements, see *Example 3: Taking Automated Measurements* on page 2–19.

To learn how the oscilloscope calculates each automatic measurement, see *Appendix B: Algorithms* on page B–1.

Taking Cursor Measurements

The TDS Oscilloscope provides cursors that measure the difference (either in time or voltage) between two locations in a waveform record. This section describes cursors — how to select their type and mode, how to display them, and how to use them to take measurements.

Cursor measurements are fast and easy-to-take. Cursors are made up of two markers that you position with the general purpose knob. You move one cursor independently or both cursors in tandem, depending on the cursor mode. As you position the cursors, readouts on the display report and update measurement information.

Cursor Types

There are three cursor types: *horizontal bar*, *vertical bar*, and *paired* (see Figure 3–58).

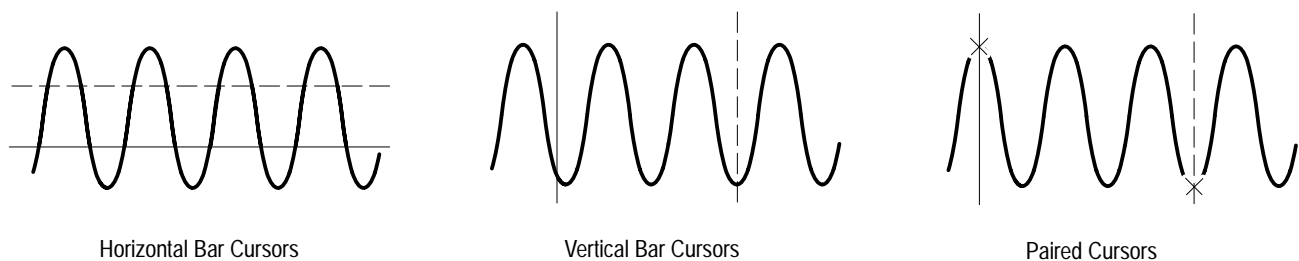

Figure 3–58: Cursor Types

Horizontal bar cursors measure vertical parameters (typically volts).

Vertical bar cursors measure horizontal parameters (typically time or frequency).

Paired cursors measure both vertical parameters (typically volts) and horizontal parameters (typically time) simultaneously.

Look at Figure 3–58. Note that each of the two paired cursors has a long vertical bar paired with an X. The Xs measure vertical parameters (typically volts); the long vertical bars measure horizontal parameters (typically time or frequency). (See *Cursor Readouts* on page 3–98 for more information.)

NOTE. When cursors measure certain math waveforms, the measurement may not be of time, frequency, or voltage. Cursor measurement of those math waveforms that are not of time, frequency, or voltage is described in Waveform Math, which begins on page 3-142.

Cursor Modes

There are two cursor modes: *independent* and *tracking*. (See Figure 3-59.)

In independent mode, you move only one cursor at a time using the general purpose knob. The active, or selected, cursor is a solid line. Press **SELECT** to change which cursor is selected.

In tracking mode, you normally move both cursors in tandem using the general purpose knob. The two cursors remain a fixed distance (time or voltage) from each other. Press **SELECT** to temporarily suspend cursor tracking. You can then use the general purpose knob to adjust the distance of the solid cursor relative to the dashed cursor. A second push toggles the cursors back to tracking.

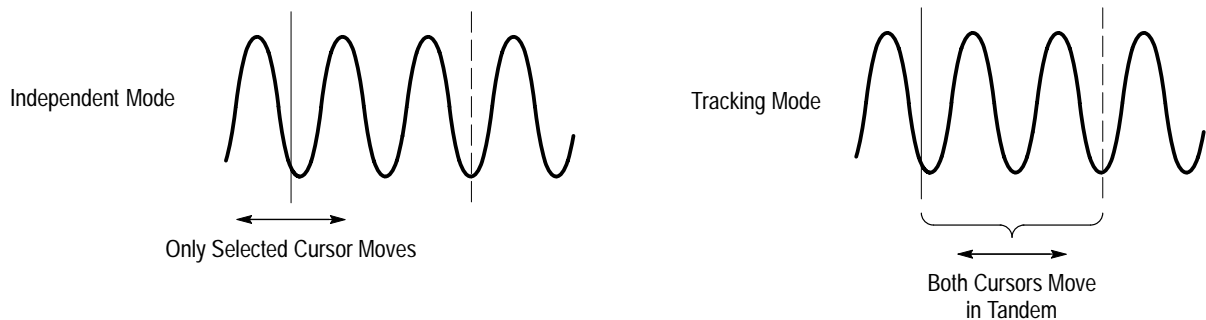

Figure 3-59: Cursor Modes

Cursor Readouts

The cursor readout shows the absolute location of the selected cursor and the difference between the selected and non-selected cursor. The readouts differ depending on the cursor type you select, H Bars, V Bars, or Paired.

H Bars. The value after Δ shows the voltage difference between the cursors. The value after @ shows the voltage of the selected cursor relative to ground. (See Figure 3-60.) With the video trigger option, you can also display the voltage in IRE units.

V Bars. The value after Δ shows the time (or frequency) difference between the cursors. The value after @ shows the time (frequency) of the selected cursor relative to the trigger point. With the video trigger option, you can also display the line number.

TDS 700A Models Only: In FastFrame mode, the @ shows the time position of the selected cursor relative to the trigger point of the frame that the selected cursor is in. The Δ shows the time difference between the two cursors only if both cursors are in the same frame.

Paired. The value after one Δ shows the voltage difference between the two Xs; the other Δ shows the time (or frequency) difference between the two long vertical bars. The value after @ shows the voltage at the X of the selected cursor relative to ground. (See Figure 3–61.)

TDS 700A Models Only: In FastFrame mode, the Δ shows the time difference between the two cursors only if both cursors are in the same frame.

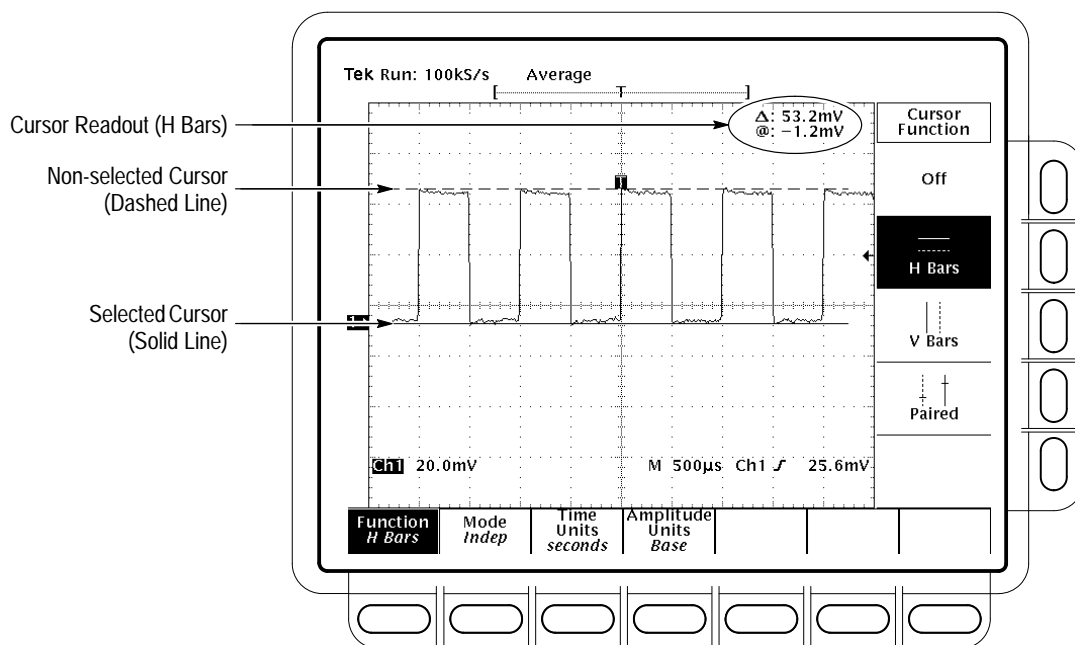

Figure 3–60: H Bars Cursor Menu and Readouts

Paired cursors can only show voltage differences when they remain on screen. If the paired cursors are moved off screen horizontally, the word Edge will replace the voltage values in the cursor readout.

Select the Cursor Function

This procedure and those that follow detail the process for taking a cursor measurement. To select the type of cursors you want, do the following steps:

1. To display the cursor menu, press **CURSOR**. (See Figure 3–60.)
2. Press **Function** (main) → **H Bars**, **V Bars**, **Paired**, or **Off** (side).

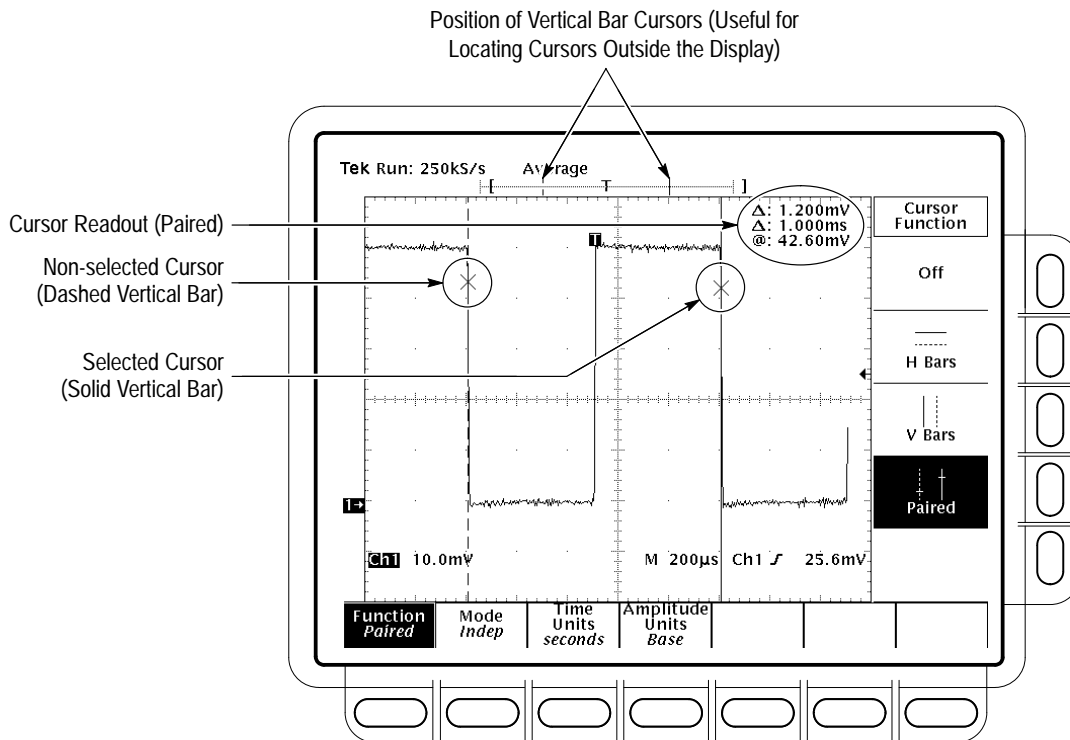

Figure 3–61: Paired Cursor Menu and Readouts

Set Mode and Adjust the Cursors

To select the cursor mode and adjust the cursors in either mode, do the following steps:

1. Press **CURSOR** → **Mode** (main) → **Independent** or **Track** (side):

Independent makes each cursor positionable without regard to the position of the other cursor.

Track makes both cursors positionable in tandem; that is, both cursors move in unison and maintain a fixed horizontal or vertical distance between each other.

2. Adjust the cursors according to the mode you have selected:

- To adjust either cursor in independent mode, use the general purpose knob to move the selected (active) cursor. A solid line indicates the adjustable cursor and a dashed line the fixed cursor. Press **Select** to toggle selection between the two cursors.
- To adjust both cursors in tracking mode, use the general purpose knob to move both cursors.
- To adjust the distance between cursors in tracking mode, press **SELECT** to temporarily suspend cursor tracking. Then use the general purpose knob to

adjust the distance of the solid cursor relative to the dashed cursor. Press **SELECT** again to resume tracking.

Select Cursor Speed To change the cursors speed, press **SHIFT** before turning the general purpose knob. The cursor moves faster when the **SHIFT** button is lighted and the display reads *Coarse Knobs* in the upper right corner.

Select Time Units You can choose to display vertical bar cursor results in units of time or frequency. If you have Option 5 Video, you can also display the results in terms of video line number. To choose vertical bar cursor units, do the following step:

Press **CURSOR → Time Units** (main) → **seconds** or **1/seconds (Hz)** or, with Option 5, **Video Line Number** (side).

Select Amplitude Units If you are measuring NTSC signals, you can choose to display vertical readings in IRE units. If you are trying to measure such a signal, you should have Option 05 Video Trigger installed as it would be difficult to trigger on composite video waveforms without Option 05. To switch between IRE and base cursor units, do the following steps:

1. Press **CURSOR → Amplitude Units** (main) → **IRE (NTSC)**.
2. To return to normal, press **CURSOR → Amplitude Units** (main) → **Base**.

To Find More Information To find instructions for using cursors with math waveforms, see *Waveform Math*, on page 3–142.

To find instructions on using cursor with FFT waveforms, differentiated waveforms, and integrated waveforms, see *Fast Fourier Transforms* on page 3–144, *Waveform Differentiation* on page 3–161, and *Waveform Integration* on page 3–165.

To find information on cursor units with video waveforms, see the *TDS Family Option 05 Video Trigger Interface*, if your oscilloscope is equipped with the video trigger option.

Taking Graticule Measurements

The TDS Oscilloscope provides a graticule for measuring the difference (either in time or amplitude) between two points on a waveform record. Graticule measurements provide you with quick, visual estimates. For example, you might look at a waveform amplitude and say “it is a little more than 100 mV.” This section briefly describes how to take graticule measurements.

Measure Waveform Amplitude

To measure the amplitude of a waveform, do the following steps:

1. Press the channel selection button of the channel you wish to measure. Note the vertical scale factor for the channel in the channel readout on screen.
2. Count the graticule divisions between two features to be measured and multiply by the vertical scale factor.

For example, if you count five major vertical graticule divisions between the minimum and maximum values of a waveform at a scale factor of 100 mV/division, then you can easily calculate your peak-to-peak voltage as:

$$5 \text{ divisions} \times 100 \text{ mV/division} = 500 \text{ mV.}$$

NOTE. When you select the NTSC graticule, the volts per division of all selected channels is set to 143 mV/div (152 mV/div for PAL) where the divisions are those of the conventional graticule, not the divisions of the video graticules. For NTSC, the actual grid lines represent 10 IRE, and for PAL the lines are 100 mV apart.

Measure Waveform Time

To measure the time of a waveform, repeat the process just described, but count the horizontal divisions and multiply by the horizontal scale factor. For example, if you count five major vertical graticule divisions for one waveform cycle at a horizontal scale factor of 50 μ S/division, then you can easily calculate the waveform period as:

$$5 \text{ divisions} \times 50 \mu\text{S/division} = 250 \mu\text{s, or } 4 \text{ kHz.}$$

Optimizing Measurement Accuracy: SPC and Probe Cal

The TDS Oscilloscope provides two features that optimize measurement accuracy. *Signal Path Compensation (SPC)* lets you compensate the internal signal path used to acquire the waveforms you acquire and measure based on the ambient temperature. *Probe Cal* lets you compensate the entire signal path, from probe tip to digitized signal, to improve the gain and offset accuracy of the probe. This section tells you how to use both features.

Signal Path Compensation

The TDS Oscilloscope lets you compensate the internal signal path used to acquire the waveforms you measure. SPC optimizes the oscilloscope capability to make accurate measurements based on the ambient temperature.

Run an SPC anytime you wish to ensure that the measurements you make are made with the most accuracy possible. You should also run an SPC if the temperature has changed more than 5° C since the last SPC was performed.

NOTE. *When making measurements at volts/division settings less than or equal to 5 mV, you should run SPC at least once per week. Failure to do so may result in the oscilloscope not meeting warranted performance levels at those volts/div settings. (Warranted characteristics are listed in the Performance Verification and Specifications manual.)*

To run an SPC, do the following steps:

1. Power on the digitizing oscilloscope and allow a 20 minute warm-up before doing this procedure.
2. Disconnect any input signals you may have connected from all four input channels.

STOP. *When doing steps 3 and 4, do not turn off the oscilloscope until signal path compensation completes. If you interrupt (or lose) power to the instrument while signal path compensation is running, a message is logged in the oscilloscope error log. If such a case occurs, rerun signal path compensation.*

3. Press **SHIFT UTILITY** → **System** (main) → **Cal** (pop-up) → **Signal Path** (main) → **OK Compensate Signal Paths** (side).
4. Wait for signal path compensation to complete (up to 15 minutes). While it progresses, a “clock” icon (shown at left) is displayed on-screen. When compensation completes, the status message will be updated to *Pass* or *Fail* in the main menu.
5. Verify the word *Pass* appears under **Signal Path** in the main menu. (See Figure 3–62.)



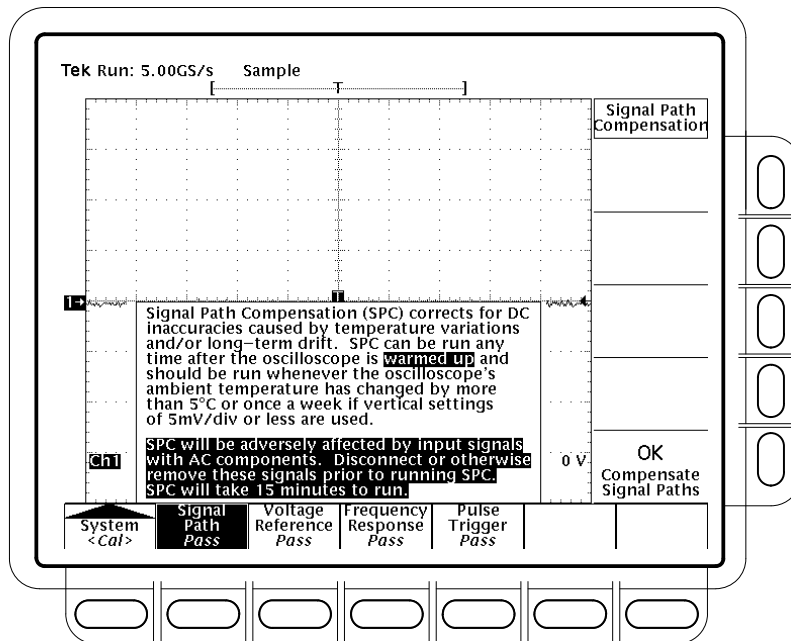

Figure 3–62: Performing a Signal Path Compensation

Probe Cal The TDS Oscilloscope lets you compensate the probe, based on the channel it is connected to, to improve the gain and offset accuracy of the probe. By executing *Probe Cal* on a channel with its probe installed, you can optimize the oscilloscope capability to make accurate measurements using that channel and probe.

Run a Probe Cal anytime you wish to ensure that the measurements you make are made with the most accuracy possible. You should also run a Probe Cal if you have changed to a different probe since the last Probe Cal was performed.

Some Probes Cannot Be Compensated. Some types of probes can be gain compensated, some can be offset compensated, and some can be compensated for both. *Some probes cannot be compensated at all.* Note the following restrictions:

- The oscilloscope cannot compensate probes that have an attenuation factor of greater than 20X. If you attempt to compensate such a probe you will get an error message.
- The oscilloscope cannot compensate probes that have gain and/or offset errors that are too great ($> 2\%$ gain and/or > 50 mV offset). If these errors are within specified limits for your probe, you may want to use another probe. If they are not within specification, have your probe checked by service personnel.

NOTE. *Probe Cal is not recommended with the P6139A passive probe. This probe typically has little gain and offset error, and therefore, the improvement in performance after a Probe Cal is not worth the time needed to do the Probe Cal. Probe Cal makes significant performance improvements when performed with active probes or older passive probes.*

To run a probe cal, follow the instructions regarding prerequisites below and then do the steps that follow:

- If you are installing an *active* probe, such as the P6245, there are no prerequisites to performing this procedure. Start at step 1.
 - If you are compensating for a *passive* probe with this procedure you must first compensate the low frequency response of the probe. First, do steps 1 and 2 below, and then compensate the probe by following the instructions that came with your probe. (Or see *To Compensate Passive Probes* on page 3–3.) Then continue with step 3 of this procedure.
1. Install the probe on the input channel on which it is to be used.
 2. Power on the digitizing oscilloscope and allow a 20 minute warm-up before doing this procedure.
 3. Press **SHIFT UTILITY** → **System** (main) → **Cal** (pop-up).
 4. Look at the status label under **Signal Path** in the main menu. If the status does not read **Pass**, perform a signal path compensation (*Signal Path Compensation*, page 3–102), and then continue with this procedure.
 5. Press the front-panel button corresponding to the input channel on which you installed the probe.
 6. Press **VERTICAL MENU** → **Cal Probe** (main).

STOP. *Your oscilloscope will detect the type of probe you have installed and display screen messages and menu choices for compensation of probe gain, offset, or both. (See Figure 3–63.) The following steps will have you run probe gain, offset, or both depending on the probe the oscilloscope detects.*

7. If the message on screen is *Probe Offset Compensation* rather than *Probe Gain Compensation*, skip to step 15.
8. Connect the probe tip to **PROBE COMPENSATION SIGNAL**; connect the probe ground lead to **PROBE COMPENSATION GND**.
9. Press **OK Compensate Gain** (side).
10. Wait for gain compensation to complete (one to three minutes).



When gain compensation completes, the following actions occur:

- The clock icon will disappear.
- If offset compensation is required for the probe installed, the Probe *Offset* Compensation message will replace the Probe *Gain* Compensation message.
- If gain compensation did not complete successfully, you may get a “Probe is not connected” message (examine the probe connections to the digitizing oscilloscope, be sure the probe tip is properly installed in its retractor, etc., and repeat step 9).
- If gain compensation did not complete successfully, you may get the message “Compensation Error.” This error implies that the probe gain (2% error) and/or offset (50 mV) is too great to be compensated. You can substitute another probe and continue. Have your probe checked by service personnel.

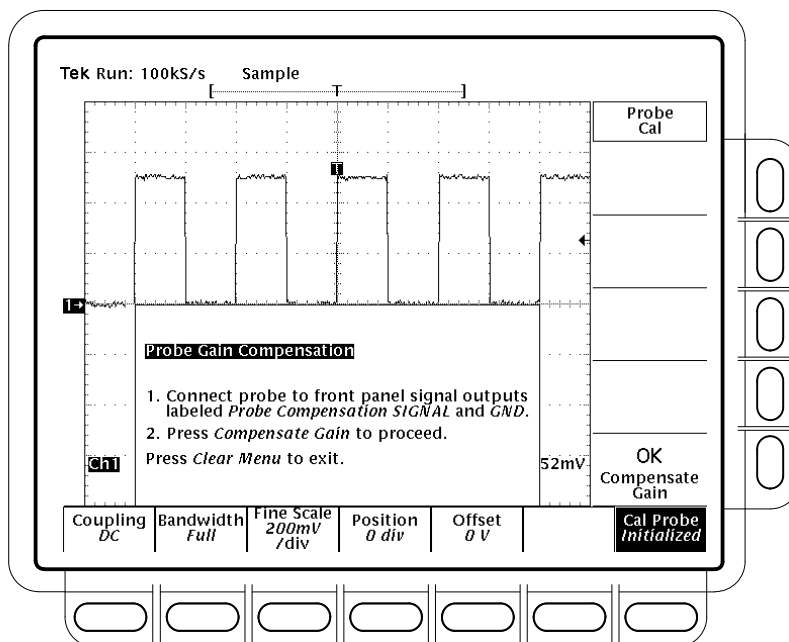

Figure 3–63: Probe Cal Menu and Gain Compensation Display

11. If the Probe *Offset* Compensation message is displayed, continue with step 15; otherwise, continue with step 12.
12. If the Compensation Error message is displayed, continue with step 13; otherwise continue with step 18.

13. Press **SHIFT UTILITY** → **System** (main) → **Diag/Err** (pop-up) → **Error Log** (main). If there are too many error messages to be seen on screen, rotate the general purpose knob clockwise to scroll to the last message.
14. Note the compensation error amount. Skip to step 19.
15. Disconnect the probe from any signal you may have connected it to. Leave the probe installed on its channel.
16. Press **OK Compensate Offset** (side).
17. Wait for offset compensation to complete (one to three minutes).



When offset compensation completes, the following occurs:

- The clock icon will disappear.
 - If offset compensation did not complete successfully, you may get the message “Compensation Error.” This error implies that the probe offset scale (10% error) and/or offset (50 mV) is too great to be compensated. You can substitute another probe and continue. Have your probe checked by service personnel. You can also check the error log by doing steps 13 through 14.
18. After the clock icon is removed, verify the word **Initialized** changed to **Pass** under **Cal Probe** in the main menu. (See Figure 3–63.)
 19. If desired, repeat this procedure beginning at step 1 to compensate for other probe/channel combinations. But before you do so, be sure you take note of the following requirements:
 - Remember to first low frequency compensate any passive probe you connect (see the prerequisites listed on page 3–105 at the beginning of this procedure).
 - Remember to connect all but simple passive probes to the oscilloscope for a twenty minute warm up before running Probe Cal.

Changing Probes After a Probe Cal. If a Probe Cal has never been performed on an input channel or if its stored Probe Cal data is erased using the *Re-use Probe Calibration Data* menu (discussed later), the oscilloscope displays *Initialized* status in its vertical menu. It also displays initialized whenever you remove a probe from an input.

If you execute a successful Probe Cal on an input channel, the oscilloscope stores the compensation data it derived in nonvolatile memory. Therefore, this data is available when you turn the oscilloscope off and back on and when you change probes.

When you install a probe or power on the oscilloscope with probes installed, the oscilloscope tests the probe at each input. Depending on the probe it finds on each input, it takes one of the following actions:

- If the probe has a TEKPROBE interface (such an interface can convey additional information, such as a unique identification number), the oscilloscope determines whether it is the same probe for which data was stored. If it is, the oscilloscope sets status to pass; if not, it sets the status to *Initialized*.
- If a probe has a simple oscilloscope interface, the oscilloscope can usually determine if it has a different probe attenuation factor than that stored for the last Probe Cal. It can also determine if the last Probe Cal was for a probe with a TEKPROBE interface. If either is the case, the probe installed is different from that stored for the last Probe Cal. Therefore, the oscilloscope sets the status to *Initialized*.
- If a probe has a simple oscilloscope interface and the probe attenuation factor is the same as was stored at the last Probe Cal, the oscilloscope cannot determine whether it is the same probe. Therefore, it displays the *Re-use Probe Calibration data?* menu. (See Figure 3–64.)

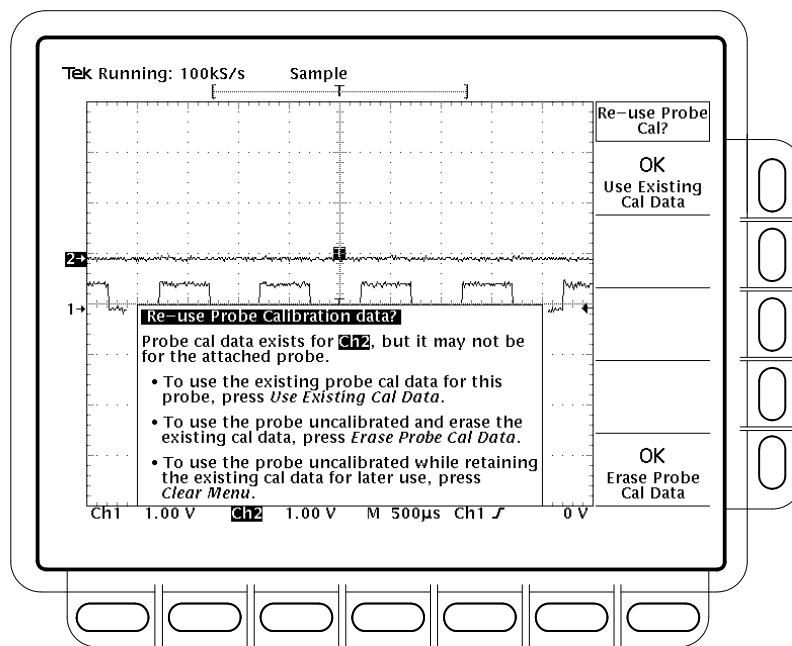

Figure 3–64: Re-use Probe Calibration Data Menu

If the *Re-use Probe Calibration data?* menu is displayed, you can choose one of the following options:

- Press **OK Use Existing Data** (side) to *use* the Probe Cal data last stored to compensate the probe.
- Press **OK Erase Probe Cal Data** (side) to *erase* the Probe Cal data last stored and use the probe uncompensated.
- Press **CLEAR MENU** on the front panel to *retain* the Probe Cal data last stored and use the probe uncompensated.

NOTE. *If the Re-use Probe Calibration data menu is displayed, do not select OK Use Existing Data if the probe currently installed is not of the same impedance stored for the Probe Cal. For example, if the last Probe Cal stored for a channel was done with a passive 50 Ω probe installed, do not install a passive 1 MΩ probe and select OK Use Existing Data if the menu appears. If you do so, most of any signal you attempt to measure will not be coupled to the input channel because of the probe to oscilloscope impedance mismatch.*

Table 3–10 shows the action the oscilloscope takes based on the probe connected and user operation performed.

Table 3–10: Probe Cal Status

Probe Cal'd? ¹	User Action	Type Probe Connected ²	
		Simple Interface ³	TEKPROBE Interface ⁴
No	Doesn't Matter	<i>Initialized</i>	<i>Initialized</i>
Yes	Power off	<i>Initialized</i> (probe data is retained)	<i>Initialized</i> (probe data is retained)
Yes	Power on	Can not detect different probe: <i>Initialized</i>	Display <i>Re-use Probe Calibration Data</i> menu Cal'd Probe: <i>Pass</i>
		Different probe: <i>Initialized</i>	Different probe: <i>Initialized</i>
Yes	Disconnect Probe	<i>Initialized</i>	<i>Initialized</i>
Yes	Connect Probe	Can not detect different probe: <i>Initialized</i>	Display <i>Re-use Probe Calibration Data</i> menu Cal'd Probe: <i>Pass</i>
		Different probe: <i>Initialized</i>	Different probe: <i>Initialized</i>

¹ Refers to a channel input that was *successfully* compensated at the time Probe Cal was last executed for the input channel.

² If no probe is connected, the probe status in the vertical main menu is always *initialized*.

³ A probe with a simple interface is a probe that can convey very limited information to the oscilloscope. Most passive probes (such as the P6139A) have simple interfaces.

⁴ A probe with a TEKPROBE interface is a probe that can convey additional information. For instance, it might automatically set the oscilloscope input channel impedance to match the probe, send the oscilloscope a unique probe identification number, and so on. Some optical probes and most active probes (such as the P6205) have TEKPROBE interfaces.

Saving Waveforms and Setups

The TDS Oscilloscope can save and recall the waveforms you measure and the setups you use to measure them. It can also output or save a copy of its display screen. This section describes how to use the following features to save, recall, and document your measurements:

- *Save/Recall Setups*, for saving the setups you create to internal memory or to a floppy disk, so you can recall and reuse those setups
- *Save/Recall Waveform* for saving waveforms to internal memory or to a floppy disk and for recalling those waveforms to the display
- *Hardcopy* for printing a copy of the oscilloscope display screen or for saving it to floppy disk (hardcopies can be incorporated into documents using desktop publishing software)
- *File Utilities* for managing (copying, organizing into directories, and so on) the setups, waveforms, and display screens that you save to floppy disk

This section ends with details on how to connect your oscilloscope into a system environment, so that it can communicate with remote instruments.

Saving and Recalling Setups

The TDS Oscilloscope can store up to ten instrument setups in internal memory that you may later recall. This subsection describes how you save and recall a setup, and how you can recall the factory default setup.

Save a setup when you want to reuse it later. For example, after changing the setting during the course of an experiment, you may want to quickly return to your original setup. Save setups are retained even when you turn the oscilloscope off or unplug it.

To Save a Setup

To save the current setup of the oscilloscope:

1. Press **SAVE/RECALL SETUP** → **Save Current Setup** (main).

STOP. Before doing step 2 that follows, note that if you choose a setup location labeled user, you will overwrite the user setup previously stored there. You can store setups in setup locations labeled factory without disturbing previously stored setups.

2. To store to a setup internally, choose one of the ten internal storage locations from the side menu **To Setup 1, To Setup 2, ...** (see Figure 3–65). Now the current setup is stored in that location.
3. To store a setup to disk, press **To File** (side). Then use the general purpose knob to select the exact file from the resulting scrollbar list. Finally, press **Save To Selected File** (side) to complete the operation.

NOTE. Upon power on, the oscilloscope creates the “wild card” file TEK?????.SET for storing setups. Selecting this file in step 3 stores a setup in a uniquely named, sequentially numbered file. For instance, the oscilloscope saves the first setup you save in the file TEK00001.SET, the second in TEK00002.SET, and so on.

To Recall a Setup

To recall a setup, do the following steps:

1. To recall a setup stored internally, press **SAVE/RECALL SETUP → Recall Saved Setup** (main) → **Recall Setup 1, Recall Setup 2 ...** (side).
2. To recall a setup stored on disk, press **From File** (side). Then use the general purpose knob to select the exact file from the resulting scrollbar list. Only files with .set extensions will be displayed. Finally, press **Recall From Selected File** (side) to complete the operation.

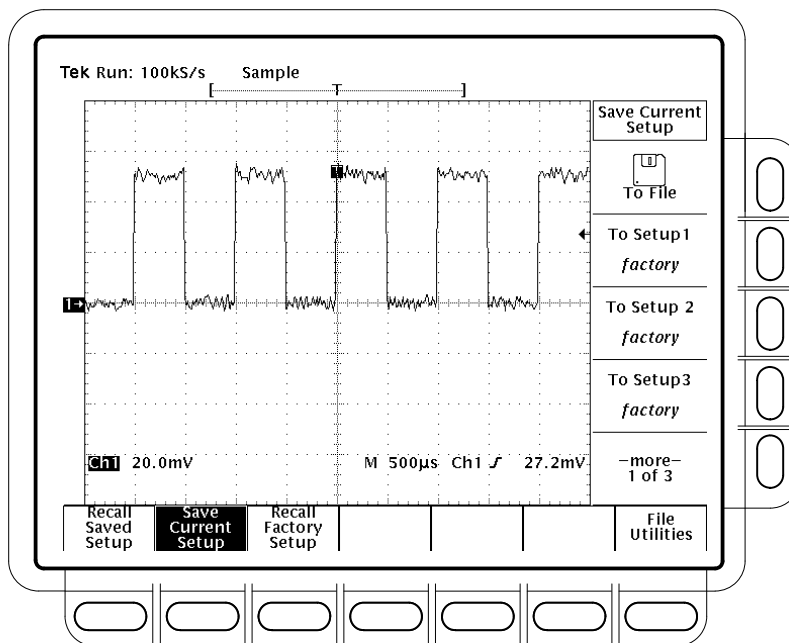

Figure 3–65: Save/Recall Setup Menu

Recalling a setup will not change the menu that is currently displayed. If you recall a setup that is labeled *factory* in the side menu, you will recall the factory setup. (The conventional method for recalling the factory setup is described below.)

To Recall the Factory Setup

To reset your oscilloscope to the factory defaults:

Press **SAVE/RECALL SETUP** → **Recall Factory Setup** (main) → **OK Confirm Factory Init** (side).

See *Factory Initialization Settings*, on page D–1, for a list of the factory defaults.

To Delete All Setups and Waveforms — Tek Secure®

Sometimes you might use the oscilloscope to acquire waveforms that are confidential. Furthermore, before returning the oscilloscope to general usage, you might want to remove all such waveforms and any setups used to acquire them. (Be sure you *want* to remove *all* waveforms and setups, because once they are removed, you cannot retrieve them.) To use Tek Secure to remove all reference setups and waveforms (does not affect mass storage disk):

Press **SHIFT UTILITY** → **System** (main) → **Config** (pop-up) → **Tek Secure Erase Memory** (main) → **OK Erase Setup & Ref Memory** (side).

Executing Tek Secure accomplishes the following tasks:

- Replaces all waveforms in reference memories with zero sample values.
- Replaces the current front panel setup and all setups stored in setup memory with the factory setup.
- Calculates the checksums of all waveform memory and setup memory locations to verify successful completion of setup and waveform erasure.
- If the checksum calculation is unsuccessful, displays a warning message; if the checksum calculation is successful, displays a confirmation message.

To Run the File Utilities

To run file utilities, see the *Managing the File System* on page 3–117.

To Find More Information

See *Example 4: Saving Setups*, on page 2–24.

See *Appendix D: Factory Initialization Settings* on page D–1.

Saving and Recalling Waveforms

TDS Oscilloscope provides four internal reference memories in any of which you can store a waveform. Waveform thus stored are retained even when you turn the oscilloscope off or unplug it. The oscilloscope also can save waveforms to floppy disk. This subsection describes how to save, delete, and display reference waveforms.

The oscilloscope can display up to 11 waveforms at one time. That includes waveforms from the four input channels, four reference waveforms, and three math waveforms. You can save any combination of different size waveform records.

You will find saving waveforms useful when working with many waveforms and channels. If you have more waveforms than you can display, you can save one of the waveforms and then stop acquiring it. By doing so, you free an input channel to display another waveform without losing the first one.

To Save a Waveform

To save a waveform, do the following steps:

1. Select the channel that has the waveform you want to save.

STOP. Before doing step 2 that follows, note that if you choose a reference memory location labeled active (see Figure 3-66), you will overwrite the waveform that was previously stored there. You can store waveforms in reference locations labeled empty without disturbing previously stored waveforms.

2. To store a waveform internally, press **SAVE/RECALL WAVEFORM** → **Save Wfm** (main) → **To Ref1, To Ref2, To Ref3, or To Ref4** (side).
3. To store a waveform to disk, press **To File** (side). Then use the general purpose knob to select the exact file from the resulting scrollbar list. Finally, press **Save To Selected File** (side) to complete the operation.

NOTE. Upon power on, the oscilloscope creates the “wild card” file **TEK?????.WFM** for storing waveforms. Selecting this file in step 3 stores a waveform in a uniquely named, sequentially numbered file. For instance, the oscilloscope saves the first waveform you save in the file **TEK00001.WFM**, the second in **TEK00002.WFM**, and so on.

**To Change Format
(TDS 700A Models)**

TDS 700A Models Only: To select the format that the oscilloscope uses to save waveforms to a disk, press save/recall **WAVEFORM** → **Save Format** (main) → **Internal**, **MathCad**, or **Spreadsheet** (side).

Internal creates files (.WFM) in the internal format of the oscilloscope.

MathCad creates files (.DAT) in a format usable by MathCad®.

Spreadsheet creates files (.CSV) in a format usable by spreadsheets (Excel®, Lotus 1-2-3®, and Quattro Pro®).

To Delete Waveforms

To delete a reference waveform(s) that you no longer need:

Press **SAVE/RECALL WAVEFORM** → **Delete Refs** (main) → **Delete Ref1**, **Delete Ref2**, **Delete Ref3**, **Delete Ref4**, or **Delete All Refs** (side).

**To Delete All Waveforms
and Setups**

To remove *all* stored reference waveforms and setups, use the feature called Tek Secure. See *To Delete All Setups and Waveforms* on page 3–113.

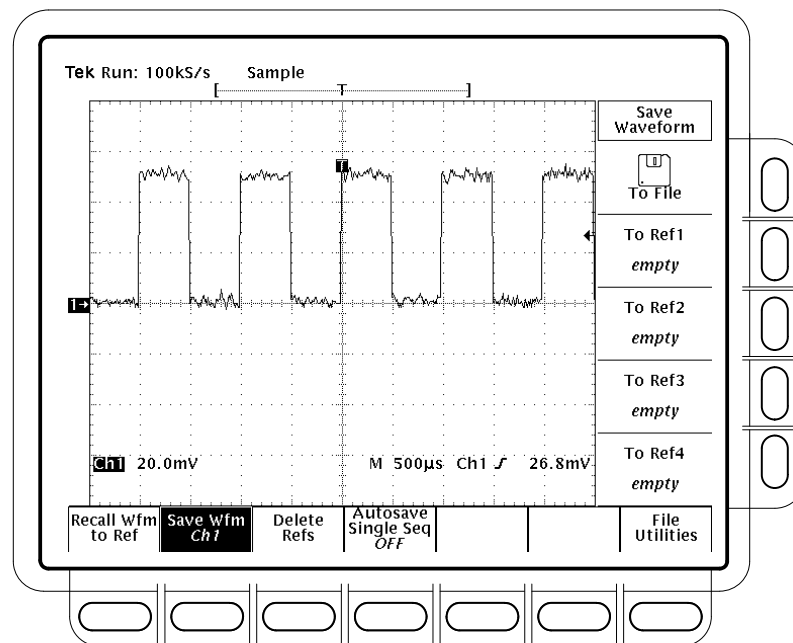

Figure 3–66: Save Waveform Menu

**To Display a
Saved Waveform**

To display a waveform in internal reference memory:

Press **MORE** → **Ref1**, **Ref2**, **Ref3**, or **Ref4** (main). (See Figure 3–67.)

Note that in Figure 3–67, the main menu items Ref2, Ref3, and Ref4 appear shaded while Ref1 does not. References that are empty appear shaded in the More main menu.

To Recall a Waveform From Disk

To recall a waveform from disk to an internal reference memory, press **SAVE/RECALL WAVEFORM** → **Recall Wfm To Ref** (main) → **Recall From File** (side) Then use the general purpose knob to select the exact file from the resulting scrollbar list. Only files with .WFM extensions are displayed. Finally, press **To Ref1**, **To Ref2**, **To Ref3**, or **To Ref4** (side) to complete the operation.

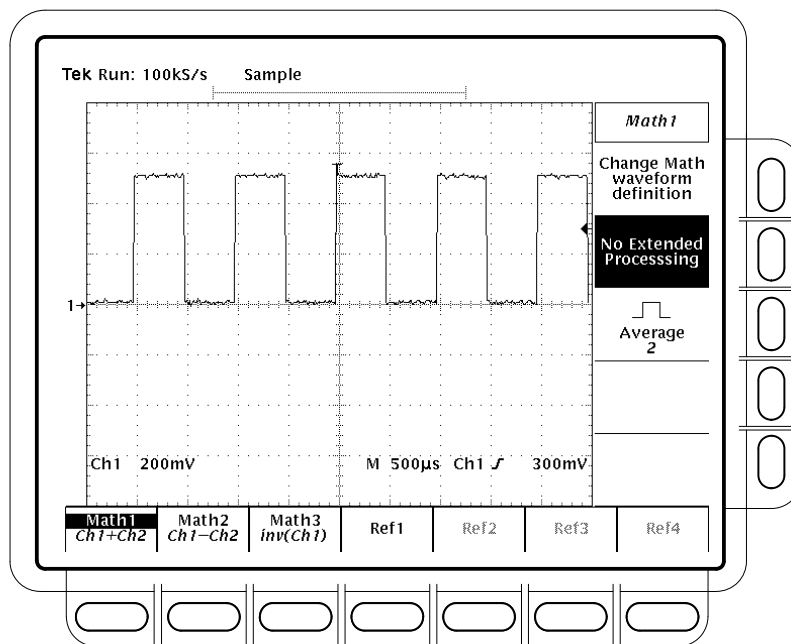

Figure 3–67: More Menu

To Enable Autosave

To use autosave, press **SAVE/RECALL WAVEFORM** → **Autosave** (main) → **Autosave Single Seq ON** (side).

Also turn on **Single Acquisition Sequence** in the Acquire menu. (See *Stop After* on page 3–25.)

To disable this feature, simply press **Autosave** (main) → **Autosave Single Seq OFF** (side).

If you enable both autosave and single sequence, the oscilloscope will save all live channels to reference waveforms at the completion of each single sequence event. All previous reference waveform data will be erased.

To rearm the oscilloscope for taking a new autosave single acquisition sequence, press RUN/STOP.

To avoid loss of reference waveforms, you can save them to floppy disk (use the SAVE/RECALL WAVEFORM menu), before rearming the oscilloscope.

Consider the following operating characteristics when using autosave.

- Autosave saves all “live” waveforms; that is, waveforms displayed in CH 1 – CH 4. To be saved, the live waveforms must be displayed on screen.
- Autosave saves each live waveform into the reference memory that corresponds to the channel (CH 1 to Ref1, CH 2 to Ref2, and so on).
- Autosave, when executing, erases all four reference memories. To avoid loss of important waveforms, you may want to save them to a floppy disk file before enabling a single acquisition sequence.
- Autosave is not available in InstaVu mode (TDS 700A models only); see *Incompatible Modes* on page 3–45.

To Run the File Utilities To run file utilities, see the *Managing the File System* on page 3–117.

Managing the File System

The TDS Oscilloscope provides file utilities and a floppy disk drive for saving hardcopies, setups, and waveforms. This subsection describes how to manage (delete, rename, etc.) these files using the file system. Read the subsections listed under *To Find More Information* on page 3–120 for information on saving hardcopies, setups, and waveforms.

To Access the File Utilities The File Utilities menu lets you delete, rename, copy, print files, create a new directory, operate the confirm delete and overwrite lock, and format disks.

To bring up the File Utilities menu:

1. Press the **SAVE/RECALL SETUP** button to bring up the Save/Recall Setup menu, or press the **SAVE/RECALL WAVEFORM** button to bring up the Save/Recall Waveform menu, or press the **SHIFT HARDCOPY** button to bring up the Hardcopy menu.
2. Press **File Utilities** in the main menu to bring up the File Utilities side menu. (See Figure 3–68.)

NOTE. The amount of free space on the disk is shown in the upper right corner of the display. The oscilloscope shows the amount in Kbytes (or in Mbytes if the free space is 1 Mbyte or more). To convert the amount to bytes, you simply multiply the Kbytes amount times 1024. Thus, the 690 Kbytes shown in Figure 3-68 = 690 Kbytes x 1024 bytes/Kbyte = 706,560 bytes.

To Delete To delete a file or directory, turn the general purpose knob until it scrolls the cursor over the name of the file or directory to delete. Then, press the side menu **Delete** button.

To delete all files in the file list, set the cursor to the *.* selection.

The oscilloscope deletes directories recursively. That means it deletes both the directories and all their contents.

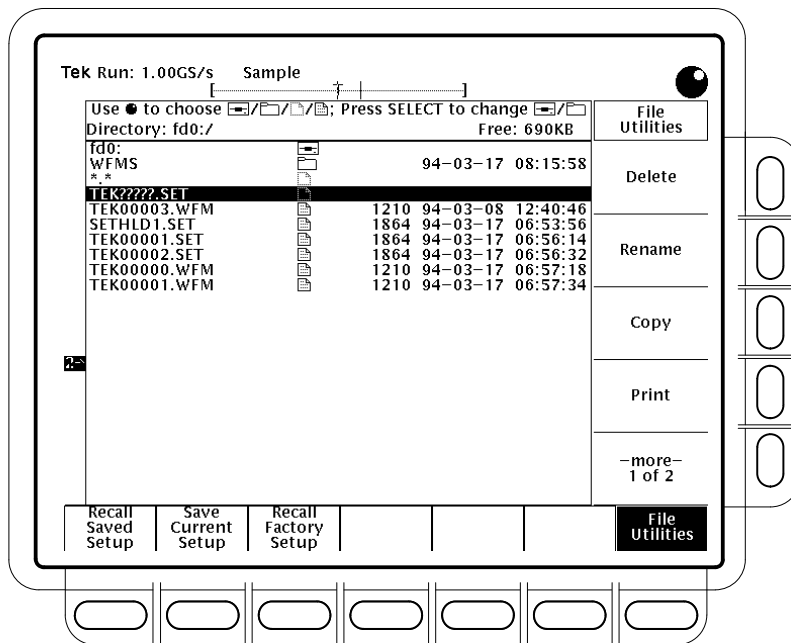

Figure 3-68: File Utilities

To Rename To rename a file or directory, turn the general purpose knob until it scrolls the cursor over the name of the file or directory to delete. For example, to rename the target file whose default name is TEK????? set the cursor over its name. Then, press the side menu **Rename** button. (See Figure 3-69).

The labeling menu should appear. Turn the general purpose knob or use the main-menu arrow keys to select each letter. Press **Enter Char** from the main

menu to enter each letter. When you have entered the name, press the side menu **OK Accept** item.

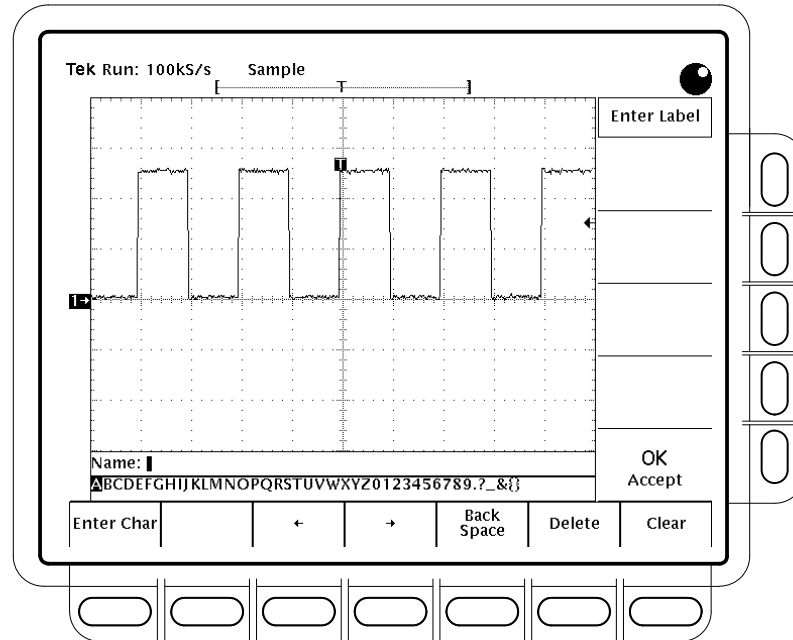

Figure 3-69: File System — Labeling Menu

To Copy To copy a file or directory, turn the general purpose knob until it scrolls the cursor over the name of the file to copy. Then, press the side menu **Copy** button. The file menu will reappear with the names of directories to copy to. Select a directory and press the side-menu button labelled **Copy <name> to Selected Directory**.

To copy all files, select the *.* entry.

The oscilloscope copies all directories recursively. That means it copies both the directories and all their contents.

To Print To print a file, turn the general purpose knob until it scrolls the cursor over the name of the file to print. Then, press the side-menu **Print** button.

The Print-to side menu should appear. Select the port to print to from **GPIO**, **RS-232**, or **Centronics**. Then the oscilloscope will send the file in its raw form out the port. The device (printer) receiving the file must be capable of printing the particular file format.

To Create a Directory To create a new directory, press the side menu **Create Directory** button.

The labeling menu should appear. Turn the general purpose knob or use the main-menu arrow keys to select each letter. Press **Enter Char** from the main menu to enter each letter. When you have entered the name, press the side menu **OK Accept** item. (See Figure 3–69.)

To Set Confirm Delete

To turn on or off the confirm delete message, toggle the side menu **Confirm Delete** button.

When the confirm delete option is OFF, the oscilloscope can immediately delete files or directories. When the confirm option is ON, the oscilloscope warns you before it deletes files and gives you a chance to reconsider

To Set Overwrite Lock

To turn on or off the file overwrite lock, toggle the side menu **Overwrite Lock** button.

When overwrite lock is on, the oscilloscope will not permit you to write over an existing file of the same name. An important reason to allow overwriting is to let you write files using a target file name that contains wild card characters (“?”). This means the oscilloscope creates sequential files whose names are similar except for the sequential numbers that go in the real name in the place of the question marks.

To Format

To format a 720 Kbyte or 1.44 Mbyte disk, turn the general purpose knob until it scrolls the cursor over the name of the drive to format in (fd0:). Then, press the side menu **Format** button.

To Find More Information

See *Saving and Recalling Setups*, on page 3–111.

See *Saving and Recalling Waveforms*, on page 3–114.

See *Printing a Hardcopy*, on page 3–120.

Printing a Hardcopy

The TDS Oscilloscope can provide you with hardcopies of its display. To obtain a hardcopy, you need to know how to configure the communication and hardcopy parameters of the oscilloscope, how to connect it to one of the many hardcopy devices it supports, and how to print the hardcopy. This subsection describes how to do these tasks and how to save a hardcopy to a floppy disk.

Supported Formats

The oscilloscope prints hardcopies of its display in many formats, which allows you to choose from a wide variety of hardcopy devices. It also makes it easier for you to place oscilloscope screen copies into a desktop publishing system. The oscilloscope supports the following formats:

- HP Thinkjet inkjet printer
- HP Deskjet inkjet printer
- HP Laserjet laser printer
- Epson
- DPU-411/II portable thermal printer
- DPU-412 portable thermal printer
- PCX® (PC Paintbrush®)
- PCX Color (PC Paintbrush®)
- TIFF® (Tag Image File Format)
- BMP® Mono (Microsoft Windows file format)
- BMP® Color (Microsoft Windows file format)
- RLE Color (Microsoft Windows color image file format – compressed)
- EPS Mono Image (Encapsulated Postscript, mono-image)
- EPS Color Image (Encapsulated Postscript, color-image)
- EPS Mono Plot (Encapsulated Postscript, mono-plot)
- EPS Color Plot (Encapsulated Postscript, color-plot)
- Interleaf
- HPGL Color Plot

Depending on the output format selected, the oscilloscope creates either an image or a plot. Images are direct bit map representations of the oscilloscope display. Plots are vector (plotted) representations of the display.

Some formats, particularly Interleaf, EPS, TIFF, PCX, BMP, and HPGL, are compatible with various desktop publishing packages. Such compatibility means you can paste files created from the oscilloscope directly into a document on any of those desktop publishing systems.

EPS Mono and Color formats are compatible with Tektronix Phaser Color Printers, HPGL is compatible with the Tektronix HC100 Plotter, and Epson is compatible with the Tektronix HC200 Printer.

To Set Up for Making Hardcopies

Before you make a hardcopy, you need to set up communications and hardcopy parameters. Do the following procedures to set up for making hardcopies.

Set Communications Parameters. To set up the communication parameters for a printer attached directly to the oscilloscope GPIB, RS-232 or Centronics port:

Press **SHIFT** → **UTILITY** → **System** (main) → **I/O** (pop-up) → **Configure** (main) → **Hardcopy (Talk Only)** (side). (See Figure 3–70.)

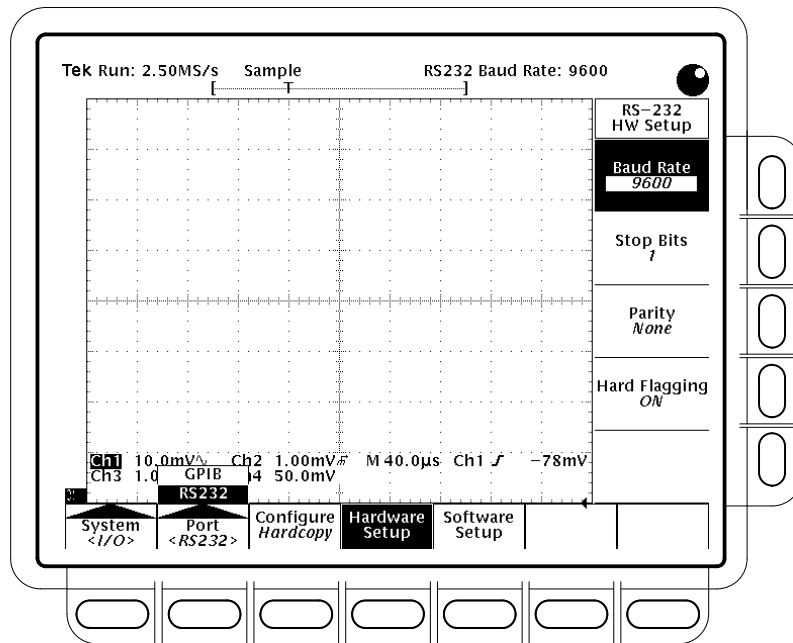

Figure 3–70: Utility Menu — System I/O

Set Hardcopy Parameters. To specify the hardcopy format, layout, and type of port using the hardcopy menu, do the following steps:

1. Press **SHIFT** → **HARDCOPY MENU** to bring up the **Hardcopy** menu.
2. Press **Format** (main) → **Thinkjet, Deskjet, Laserjet, Epson, DPU-411, DPU-412, PCX, PCX Color, TIFF, BMP Mono, BMP Color, RLE Color, EPS Mono Img, EPS Color Img, EPS Mono Plt, EPS Color Plt, Interleaf, or HPGL** (side). (Press **–more–** (side) to page through all of these format choices.)
3. Press **SHIFT** → **HARDCOPY MENU** → **Layout** (main) → **Landscape** or **Portrait** (side). (See Figure 3–71.)

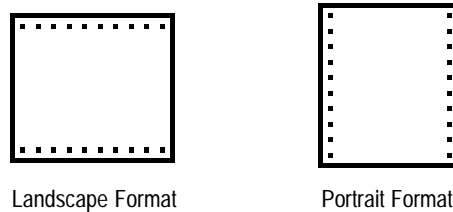

Figure 3-71: Hardcopy Formats

4. Press **SHIFT** → **HARDCOPY MENU** → **Palette** (main) → **Hardcopy** or **Current** (side) to specify a hardcopy palette. **Current** uses the current palette settings to create the hardcopy, while **Hardcopy** sets the hardcopy palette to an optimal setting for hardcopy devices.
5. Press **SHIFT** → **HARDCOPY MENU** → **Port** (main) to specify the output channel to send your hardcopy through. The choices are **GPIB**, **RS-232**, **Centronics**, and **File**.

The menu item **File** chooses the floppy disk drive as the destination for hardcopies. See *To Save to a Floppy Disk* on page 3-126.

Date/Time Stamp the Hardcopy. You can display the current date and time on screen so that they appear on the hardcopies you print. To date and time stamp your hardcopy, do the following steps:

1. Press **DISPLAY** → **Settings** (main) → **Display** (pop-up) → **Readout Options** (main) → **Display Date and Time** (side) to toggle the setting to **On**.
2. If you want to set the date and time, skip steps 3 and 4 and continue with step 1 of *Set the Date and Time* below. Then redo this procedure.
3. Press **Clear Menu** to remove the menu from the display so the date and time can be displayed. (See Figure 3-72.) (The date and time are removed from the display when menus are displayed.)
4. Once the oscilloscope is connected to a hardcopy device, press **HARDCOPY** to print your date/time stamped hardcopy.

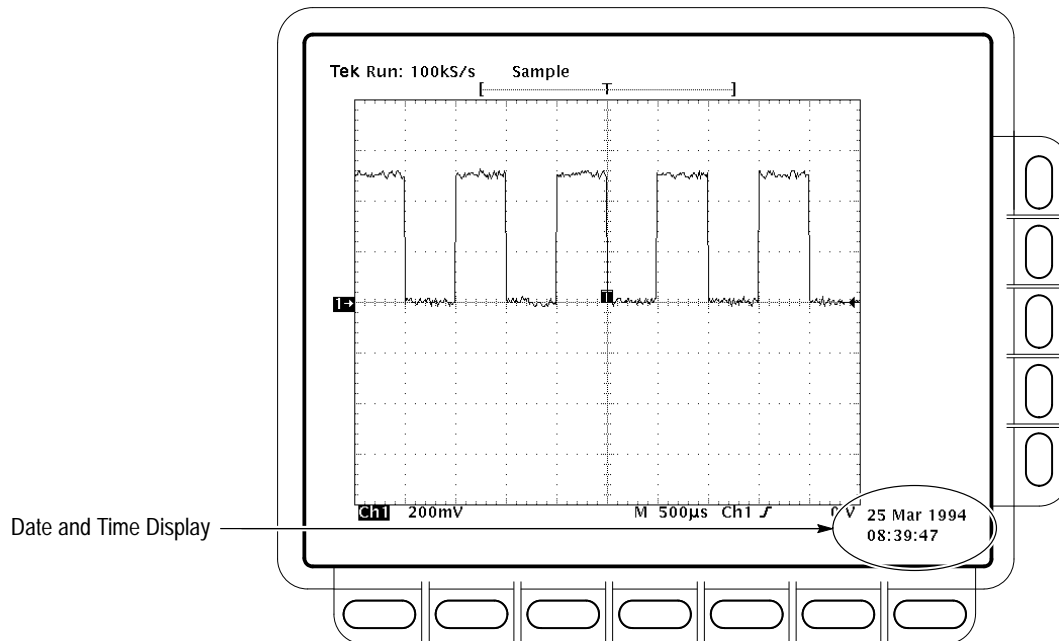

Figure 3-72: Date and Time Display

Set the Date and Time. You might need to set the date and time of the oscilloscope. To set those parameters, do the following steps.

1. Press **SHIFT** → **UTILITY** → **Config** (pop-up) → **Set Date & Time** (main) → **Year, Day Month, Hour, or Minute** (side).
2. Use the general purpose knob or the keypad to set the parameter you have chosen to the value desired. (The format when using the keypad is day.month. For example, use 23.6 for the 23rd of June.)
3. Repeat steps 1 and 2 to set other parameters as desired.
4. Press **OK Enter Date/Time** (side) to put the new settings into effect. This sets the seconds to zero.

NOTE. When setting the clock, you can set to a time slightly later than the current time and wait for it to catch up. When current time catches up to the time you have set, pressing **Ok Enter Date/Time** (side) synchronizes the set time to the current time.

5. Press **CLEAR MENU** to see the date/time displayed with the new settings.

To Print Directly to a Hardcopy Device

To make your hardcopies, use the procedures that follow.

Connect to a Hardcopy Device. To connect the oscilloscope directly to a hardcopy device, determine which interface and cable the device uses, and connect accordingly. (See Figure 3–73.)

Some devices, such as the Tektronix HC100 Plotter, use the GPIB interface. Many printers, such as the Tektronix HC200, use Centronics interfaces. Many hardcopy devices, including the HC100 and HC200 with option 03, provide RS-232 support. (Check the documentation for your hardcopy device.)

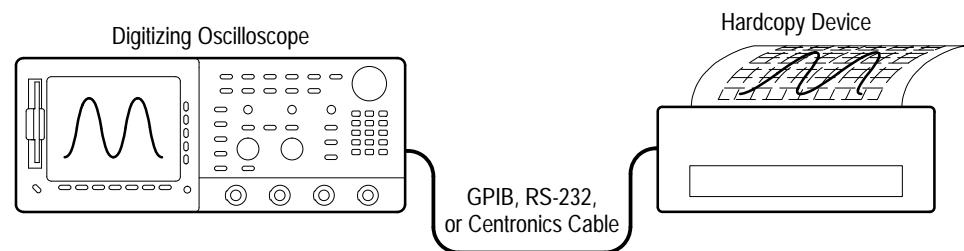

Figure 3–73: Connecting the Oscilloscope Directly to the Hardcopy Device

Print. To print a single hardcopy or send additional hardcopies to the oscilloscope spool (queue) while waiting for earlier hardcopies to finish printing, press **HARDCOPY**.

While the hardcopy is being sent to the printer, the oscilloscope will display the message “Hardcopy in process — Press **HARDCOPY** to abort.”

Abort. To stop and discard the hardcopy being sent, press **HARDCOPY** again *while* the hardcopy in process message is still on screen.

Add to the Spool. To add additional hardcopies to the printer spool, press **HARDCOPY** again *after* the hardcopy in process message is removed from the screen.

You can add hardcopies to the spool until it is full. When adding a hardcopy fills the spool, the message “Hardcopy in Process—Press **HARDCOPY** to abort” remains displayed. You can abort only the *last* hardcopy sent by pressing the button while the message is still displayed. When the printer empties enough of the spool to finish adding the last hardcopy, it does so and then removes the message.

Clear the Spool. To remove all hardcopies from the spool, press **SHIFT → HARDCOPY MENU → Clear Spool (main) → OK Confirm Clear Spool (side)**.

The oscilloscope takes advantage of any unused RAM when spooling hardcopies to printers. The size of the spool is, therefore, variable. The number of hardcopies that can be spooled depends on three variables:

- The amount of unused RAM
- The hardcopy format chosen
- The complexity of the display

Although not guaranteed, usually about 2.5 hardcopies can be spooled before the oscilloscope must wait to send the rest of the third copy.

To Save to a Floppy Disk

To send hardcopies to a floppy disk, do the following steps.

1. Set up the oscilloscope communication and hardware parameters as outlined in *To Set Up for Making Hardcopies* on page 3–122.
2. Insert a formatted 720 Kbyte or 1.44 Mbyte floppy disk into the slot at the left of the oscilloscope display.

NOTE. *To format disks, delete hardcopy files you save to disk, and otherwise manage the disk storage, see Managing the File System on page 3–117.*

3. Press **SHIFT → HARDCOPY MENU → Port (main) → File (side)** to specify that any hardcopy made be output to a file on the floppy drive. The file list and its scrollbar will appear.
4. Turn the general purpose knob to place the scroll bar over the file in which to store the hardcopy.

NOTE. *Upon power on, the oscilloscope creates the “wild card” file TEK?????.FMT for storing hardcopies, where “.FMT” is replaced by the hardcopy format you select. Selecting this file and pressing Hardcopy stores a hardcopy in a uniquely named, sequentially numbered file. For instance, the oscilloscope saves the first hardcopy you save to the file TEK00001.FMT, the second to TEK00002.FMT, and so on.*

5. Press **HARDCOPY** to print your hardcopy to the selected file.

Saving files to the floppy disk provides a convenient way to store hardcopies. You can print hardcopies stored on disk at a site remote from where the hardcopies were captured using another TDS oscilloscope. Or you might load

stored hardcopies from disk into your desktop publishing software that runs on a PC-compatible computer.

To Print Using a Controller

To make your hardcopies, use the procedures that follow.

Connect to a Hardcopy Device. To connect a controller with two ports between the oscilloscope and the hardcopy device, connect from the oscilloscope GPIB connector (rear panel) to the controller GPIB port and from the controller RS-232 or Centronics port to the hardcopy device. (See Figure 3–74.) Use the GPIB port to remotely request and receive a hardcopy from the oscilloscope. Use the RS-232 or the Centronics port on the controller to print output.

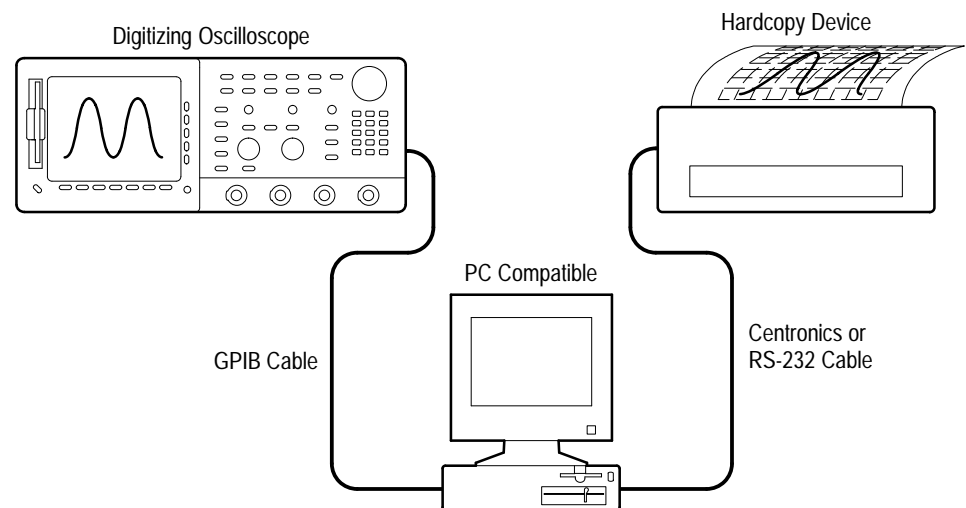

Figure 3–74: Connecting the Oscilloscope and Hardcopy Device Via a PC

Print. If your controller is PC-compatible and it uses the Tektronix GURU™ or S3FG210 (National Instruments GPIB-PCII/IIA) GPIB package, do the following steps to print a hardcopy:

1. Use the MS-DOS *cd* command to move to the directory that holds the software that came with your GPIB board. For example, if you installed the software in the GPIB-PC directory, type: **cd GPIB-PC**.
2. Run the IBIC program that came with your GPIB board. Type: **IBIC**.
3. Type: **IBFIND DEV1** where “DEV1” is the name for the oscilloscope you defined using the IBCONF.EXE program that came with the GPIB board.

NOTE. If you defined another name, use it instead of “DEV1”. Also, remember that the device address of the oscilloscope as set with the *IBCONF.EXE* program should match the address set in the oscilloscope Utility menu (typically, use “1”).

4. Type: **IBWRT “HARDCOPY START”**

NOTE. Be sure the oscilloscope Utility menu is set to Talk/Listen and not Hardcopy (Talk Only) or you will get an error message at this step. Setting the oscilloscope Utility menu is described under Set Communication Parameters on page 3–122.

5. Type: **IBRDF <Filename>** where <Filename> is a valid DOS file name with which you want to label your hardcopy file. It should be ≤ 8 characters long and up to a 3 character extension. For example, you could type “*ibrdf screen1*”.

6. Exit the IBIC program by typing: **EXIT**

7. Copy the data from your file to your hardcopy device. Type: **COPY <Filename> <Output port> ** where:

<Filename> is the name you defined in step 5 and

<Output port> is the PC output port your hardcopy device is connected to (such as LPT1 or LPT2).

For example, to copy (print) a file called *screen1* to a printer attached to the *lpt1* parallel port, type “*copy screen1 lpt1: /B*”.

Your hardcopy device should now print a picture of the oscilloscope screen.

NOTE. If you transmit hardcopy files across a computer network, use a binary (8-bit) data path.

Communicating with Remote Instruments

The TDS Oscilloscope can connect into a system environment, so that you can control it remotely or exchange measurement or waveform data between it and a computer. This subsection explains how to prepare and setup the oscilloscope for control and operation over the IEEE Std 488.2-1987 (GPIB) interface.

To Prepare for Remote Operation

To transfer data between the oscilloscope and other instruments over the GPIB, do the following tasks to make sure the instruments support GPIB protocols and observe GPIB Interface requirements.

Check for GPIB Protocols. Make sure the instruments to be connected support the GPIB protocols. These protocols cover:

- Remote instrument control
- Bidirectional data transfer
- Device compatibility
- Status and event reporting

To simplify the development of GPIB systems, include instruments that use Tektronix defined codes and formats for messages that travel over the GPIB. Each device that follows these codes and formats, such as this oscilloscope, supports standard commands. Use of instruments that support these commands can greatly simplify development of GPIB systems.

Know the GPIB Interface Requirements. To prepare to connect the oscilloscope to GPIB networks, read and follow these rules:

- Connect no more than 15 devices, including the controller, to a single bus.
- Connect one device load every two meters (about six feet) of cable length to maintain bus electrical characteristics. (Generally, each instrument represents one device load on the bus.)
- Do not exceed 20 meters (about 65 feet) of the total cumulative cable length.
- Turn on at least two-thirds of the device loads present when you use your network.
- Include only one cable path between devices on your network. (See Figure 3–75.) Do not create loop configurations.

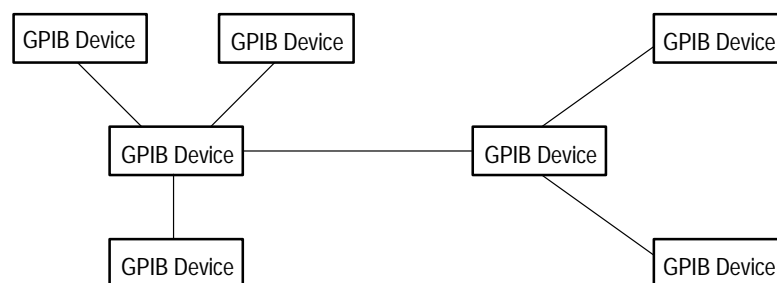

Figure 3–75: Typical GPIB Network Configuration

Obtain the Proper Interconnect Cabling. To connect the oscilloscope to a GPIB network, obtain at least one GPIB cable. Connecting two GPIB devices requires an IEEE Std 488.1-1987 GPIB cable (available from Tektronix, part number 012-0991-00).

The standard GPIB cable connects to a 24-pin GPIB connector located on the rear panel of the oscilloscope. The connector has a D-type shell and conforms to IEEE Std 488.1-1987. You can stack GPIB connectors on top of each other. (See Figure 3–76.)

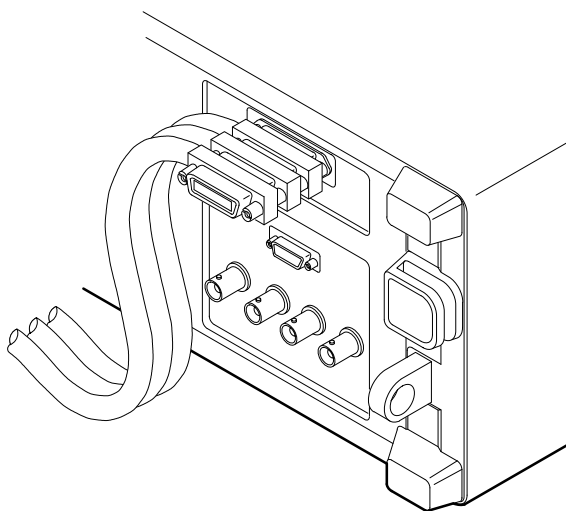

Figure 3–76: Stacking GPIB Connectors

To Set Up for Remote Operation

To set up remote communications, be sure your setup will meet GPIB protocol and interface requirements just described. Then do the following procedures.

Connect the Oscilloscope to the GPIB. To connect the oscilloscope, plug an IEEE Std 488.2-1987 GPIB cable into the GPIB connector on the oscilloscope rear panel and into the GPIB port on your controller. (See Figure 3–77.)

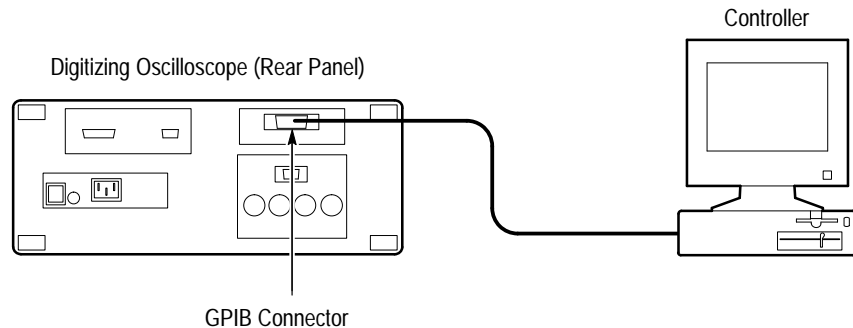

Figure 3–77: Connecting the Oscilloscope to a Controller

Select GPIB Port. To select the GPIB port, press **SHIFT → UTILITY → System (main) → I/O (pop-up) → Port (main) → GPIB (pop-up)**.

Configure the GPIB Port. You must set two important GPIB parameters: mode and address. To set those parameters:

Press **SHIFT → UTILITY → System (main) → I/O (pop-up) → Port (main) → GPIB (pop-up) → Configure (main) → Talk/Listen Address, Hardcopy (Talk Only), or Off Bus (side)**. (See Figure 3–78.)

Talk/Listen Address configures the port for controller-based system operation. Use the general purpose knob or the keypad to define the address.

Hardcopy (Talk Only) configures the port for the hardcopy output without controller supervision. Once so configured, the oscilloscope will send the hardcopy data to any listeners on the bus when the **HARDCOPY** button is pressed.

Pressing **HARDCOPY** with the port configured any other way causes an error, and the oscilloscope responds with a message saying the selected hardcopy port is currently unavailable.

Off Bus disconnects the oscilloscope from the bus.

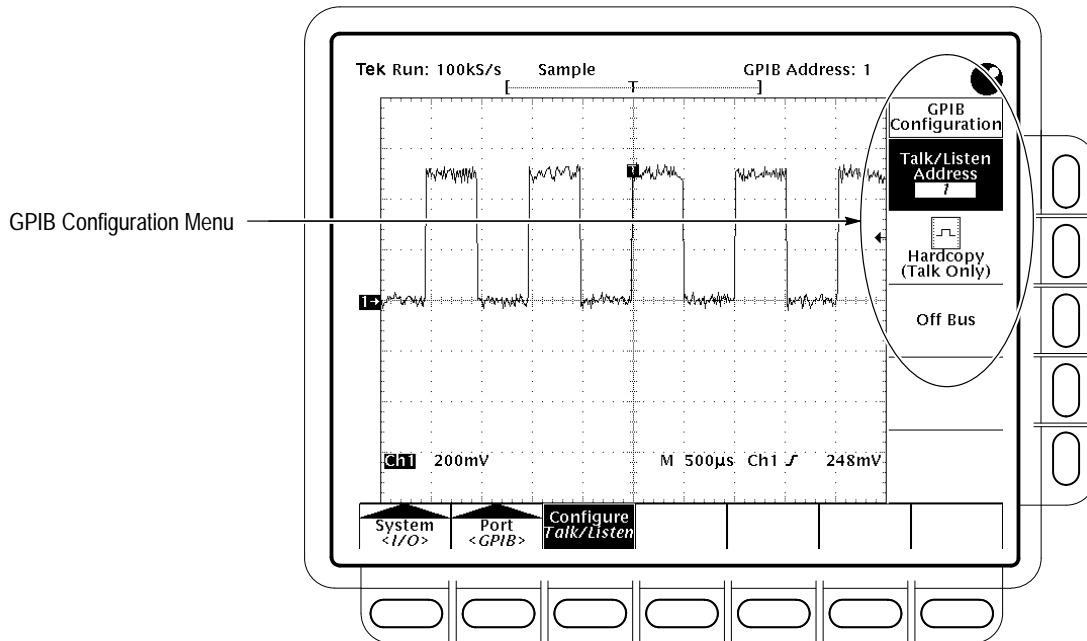

Figure 3-78: Utility Menu

To Find More Information

See *Printing a Hardcopy*, on page 3-120.

See the *TDS Programmer Manual*, Tektronix part number 070-8709-XX.

Determining Status and Accessing Help

The TDS Oscilloscope can display the status of its internal systems. It also provides an on-line help system. This section describes how to use the following two features:

- *Status* which displays a snapshot of *system, display, trigger, waveform, and I/O* settings
- *Help* which displays a screen of brief information about each oscilloscope control when that control is operated

Displaying Status

Press **SHIFT STATUS** → **Status** (main) → **System, Display, Trigger, Waveforms, or I/O** (side).

System displays information about the Horizontal, Zoom, Acquisition, Measure, and Hardcopy systems. (See Figure 3–79.) This display also tells you the firmware version.

Display provides parameter information about the display and color systems.

Trigger displays parameter information about the triggers.

Waveforms displays information about waveforms, including live, math, and reference waveforms.

I/O displays information about the I/O port(s).

Displaying the Banner

To display the banner (lists firmware version, options, copyright, and patents):

Press **SHIFT STATUS** → **Banner** (main). (See Figure 3–80.)

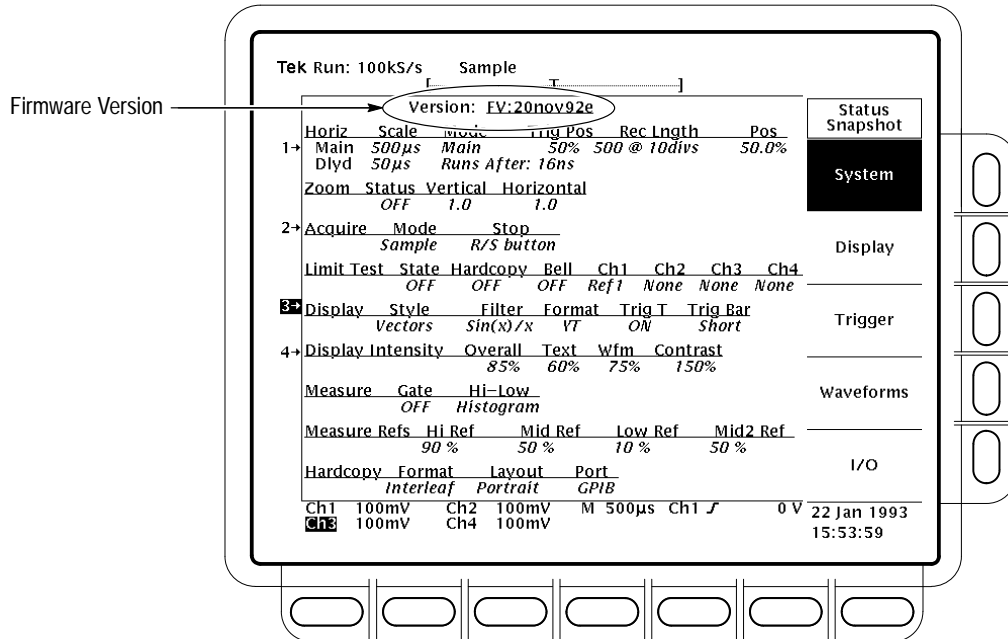

Figure 3-79: Status Menu — System

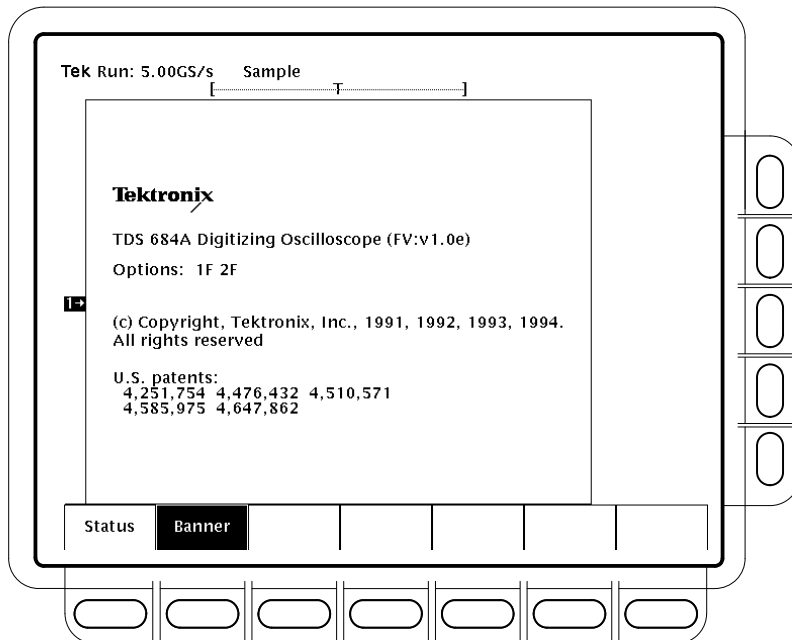

Figure 3-80: Banner Display

Displaying Help

To use the on-line help system:

Press **HELP** to provide on-screen information on any front panel button, knob or menu item. (See Figure 3–81.)

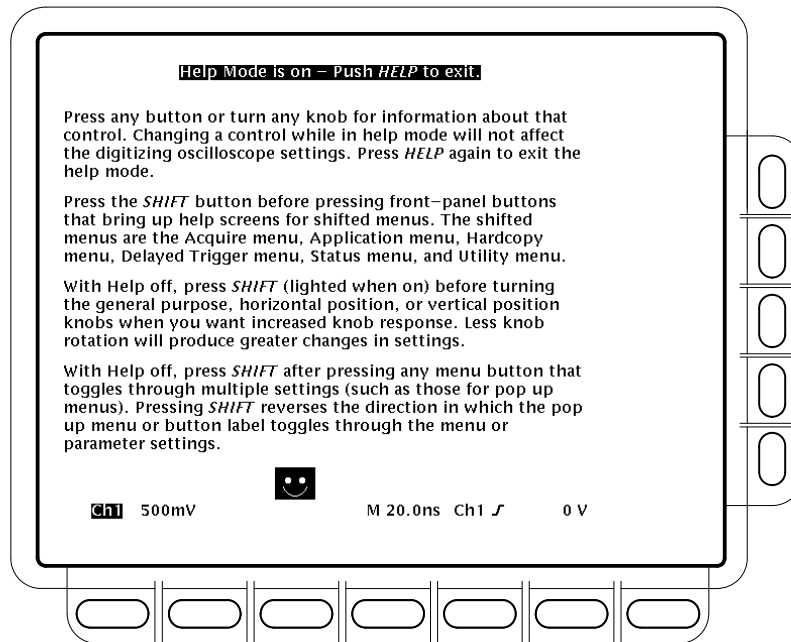

Figure 3–81: Initial Help Screen

When you press that button, the instrument changes mode to support on-line help. Press **HELP** again to return to regular operating mode. Whenever the oscilloscope is in help mode, pressing any button (except **HELP** or **SHIFT**), turning any knob, or pressing any menu item displays help text on the screen that discusses that control.

The menu selections that were displayed when **HELP** was first pressed remain on the screen. On-line help is available for each menu selection displayed at the time the **HELP** button was first pressed. If you are in help mode and want to see help on selections from menus not displayed, you first exit help mode, display the menu you want information on, and press **HELP** again to re-enter help mode.

Using Features for Advanced Applications

The TDS Oscilloscope provides powerful features for testing and digitally processing the waveforms you acquire. This section describes how to use the following features:

- *Limit Testing* — for testing the waveforms you acquire against a template you create (on this page)
- *Waveform Math* — for inverting, adding, subtracting, and multiplying of waveforms (see page 3–142)
- *Fast Fourier Transforms* — for displaying the frequency content of waveforms (see page 3–144)
- *Waveform Differentiation* — for displaying the derivative of a waveform (see page 3–161)
- *Waveform Integration* — for displaying the integral of a waveform (see page 3–165)

NOTE. If InstaVu mode is on, the features listed above are not available; press InstaVu on the front panel to toggle InstaVu mode off.

Limit Testing

The TDS Oscilloscope provides limit testing, which can automatically compare each incoming or math waveform against a template waveform. You set an envelope of limits around a waveform and the oscilloscope finds waveforms that fall outside those limits. (See Figure 3–82.) When it finds such a waveform, the oscilloscope can generate a hardcopy, ring a bell, and stop and wait for your input.

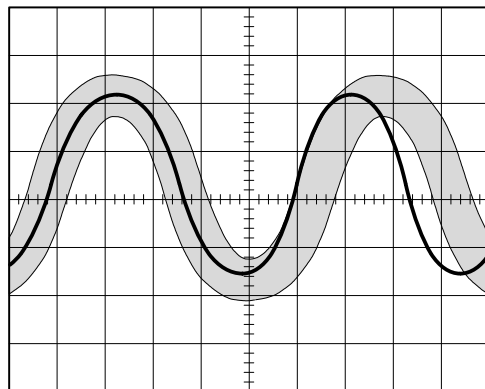

Figure 3–82: Comparing a Waveform to a Limit Template

To use limit testing, you must do four tasks:

- Create the limit test template from a waveform.
- Specify the channel to compare to the template.
- Specify the action to take if incoming waveform data exceeds the set limits.
- Turn limit testing on so that the parameters you have specified will take effect.

To do the tasks just listed, do the following procedures:

To Create Limit Test Template

To use an incoming or stored waveform to create the limit test template, first you select a source and specify a template destination. Then you create the template envelope by specifying the amount of variation from template you will tolerate.

To do these tasks, perform the following steps:

1. Press **SHIFT ACQUIRE MENU** to bring up the Acquire menu.
2. Press **Create Limit Test Template** (main) → **Template Source** (side) → **Ch1, Ch2, Math1, Math2, Math3, Ref1, Ref2, Ref3, or Ref4** (side). (See Figure 3–83.)

***NOTE.** The template will be smoother if you acquire the template waveform using Average acquisition mode. If you are unsure how to select Average, see Selecting an Acquisition Mode on page 3–23.*

3. Once you have selected a source, select a destination for the template: press **Template Destination** (side) → **Ref1, Ref2, Ref3, or Ref4**.

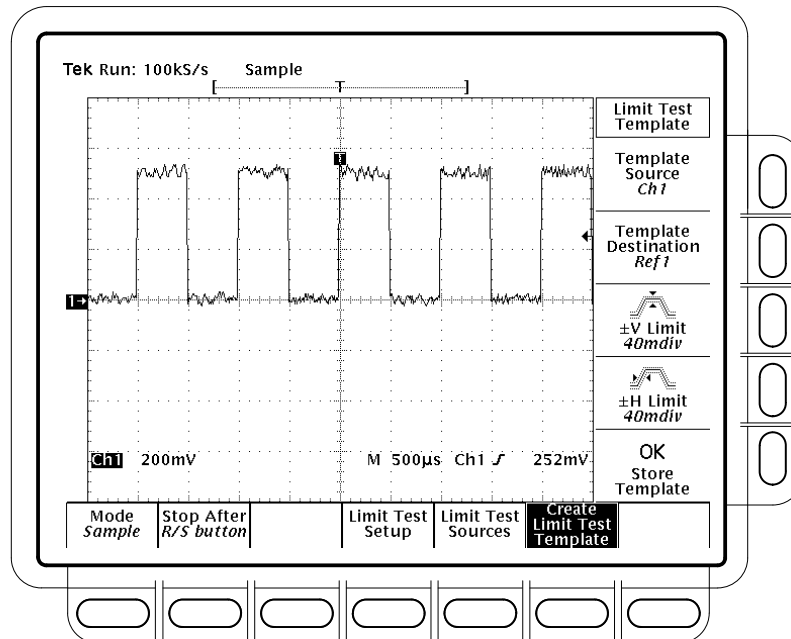

Figure 3-83: Acquire Menu — Create Limit Test Template

4. Press **±V Limit** (side). Enter the vertical (voltage) tolerance value using the general purpose knob or keypad.
5. Press **±H Limit** (side). Enter the horizontal (time) tolerance value using the general purpose knob or keypad.

Tolerance values are expressed in fractions of a major division. They represent the amount by which incoming waveform data can deviate without having exceeded the limits set in the limit test. The range is from 0 (the incoming waveform must be exactly like the template source) to 5 major divisions of tolerance.

6. When you have finished specifying the limit test template, press **OK Store Template** (side). This action stores the specified waveform in the specified destination, using the specified tolerances. Until you have done so, the template waveform has been defined but not created.

To avoid overwriting the template you have just created, store any new template you create in a different destination from that just stored.

To view the template you have created, press the **MORE** button. Then press the button corresponding to the destination reference memory you have used. The waveform appears on the display.

NOTE. To view the waveform data as well as the template envelope, it might be useful to select the Dots display style. (See Select the Display Style on page 3–28.)

To Select a Limit Test Source

Now specify the channel that will acquire the waveforms to be compared against the template you have created:

1. Press **SHIFT ACQUIRE MENU** → **Limit Test Sources** (main) → **Compare Ch1 to, Compare Ch2 to, Compare Ch3 to, Compare Ch4 to, Compare Math1 to, Compare Math2 to** or **Compare Math3 to** (side).
2. Once you have selected one of the four channels or a math waveform as a waveform source from the side menu, press the same side menu button to select one of the reference memories in which you have stored a template.

Valid selections are any of the four reference waveforms Ref1 through Ref4 or None. Choosing None turns limit testing off for the specified channel or math waveform.

NOTE. Specify the same reference memory you chose as the template destination if you wish to use the template you just created.

If you have created more than one template, you can compare one channel to one template and the other channel to another template.

To Specify the Limit Test Response

Now specify the action to take if waveform data exceeds the limits set by the limit test template and turn on limit testing:

1. Press **SHIFT ACQUIRE MENU** → **Limit Test Setup** (main) to bring up a side menu of possible actions.
2. Ensure that the side button corresponding to the desired action reads **ON**.
 - If you want to send a hardcopy command when waveform data exceeds the limits set, toggle **Hardcopy if Condition Met** (side) to **ON**. You can set the hardcopy system to send the hardcopy to the file system. (Do not forget to set up the hardcopy system. See *Hardcopy* on page 3–120 for details.)
 - If you want the bell to ring when waveform data exceeds the limits set, toggle **Ring Bell if Condition Met** (side) to **ON**.
 - If you want the oscilloscope to stop when waveform data exceeds the limits set, toggle **Stop After Limit Test Condition Met** (side) to **ON**.

NOTE. The button labeled *Stop After Limit Test Condition Met* corresponds to the *Limit Test Condition Met* menu item in the *Stop After* main menu. You can turn this button on in the *Limit Test Setup* menu, but you cannot turn it off. In order to turn it off, press *Stop After* and specify one of the other choices in the *Stop After* side menu.

3. Ensure that **Limit Test** (side) reads **ON**. If it reads **OFF**, press **Limit Test** (side) once to toggle it to **ON**.

When you set **Limit Test** to **ON**, the oscilloscope compares incoming waveforms against the waveform template stored in reference memory according to the settings in the **Limit Test Sources** side menu.

Single Waveform Comparisons

You can compare a single waveform against a single template. When making a single waveform versus a single template comparison, consider the following operating characteristics:

- The waveform will be repositioned horizontally to move the first sample in the waveform record that is outside of template limits to center screen.
- The position of the waveform template will track that of the waveform.

Multiple Waveform Comparisons

You can also compare more than one waveform against a single template, or more than one waveform with each one compared against its own template or a common template. When setting up for such comparisons, consider the following operating characteristics:

- You should set Horizontal Lock to None in the Zoom side menu (push **ZOOM** and press (repeatedly) **Horizontal Lock to None**). See *Zoom a Waveform*, on page 3–38 for more information on horizontal lock.
- With horizontal lock set as just described, the oscilloscope will reposition each waveform horizontally to move the first sample in the waveform record that is outside of template limits to center screen.
- If you are comparing each waveform to its own template, the position of each waveform template will track that of its waveform.
- If you are comparing two or more waveforms to a common template, that template will track the position of the failed waveform. If more than one waveform fails *during the same acquisition*, the template will track the position of the waveform in the highest numbered channel. For example, CH 2 is higher than CH 1.

Waveform Math

The TDS Oscilloscope provides a means for you to mathematically manipulate your waveforms. For example, you might have a waveform clouded by background noise. You can obtain a cleaner waveform by subtracting the background noise from your original waveform.

This section describes the invert, add, subtract, divide, and multiply waveform math features. See *Fast Fourier Transforms* on page 3–144, *Waveform Differentiation* on page 3–161, and *Waveform Integration* on page 3–165 for information on Advanced DSP Math features.

To Use Single Wfm Math

To perform waveform math, use the More menu (Figure 3–84). The More menu allows you to display, define, and manipulate three math waveforms; the following steps explain how to create a math waveform based on a single source waveform.

1. Press **MORE** → **Math1**, **Math2**, or **Math3** (main) → **Change Math waveform definition** (side) → **Single Wfm Math** (main).
2. To define the source waveform, press **Set Single Source to** (side) repeatedly to cycle it to the desired channel or reference waveform.

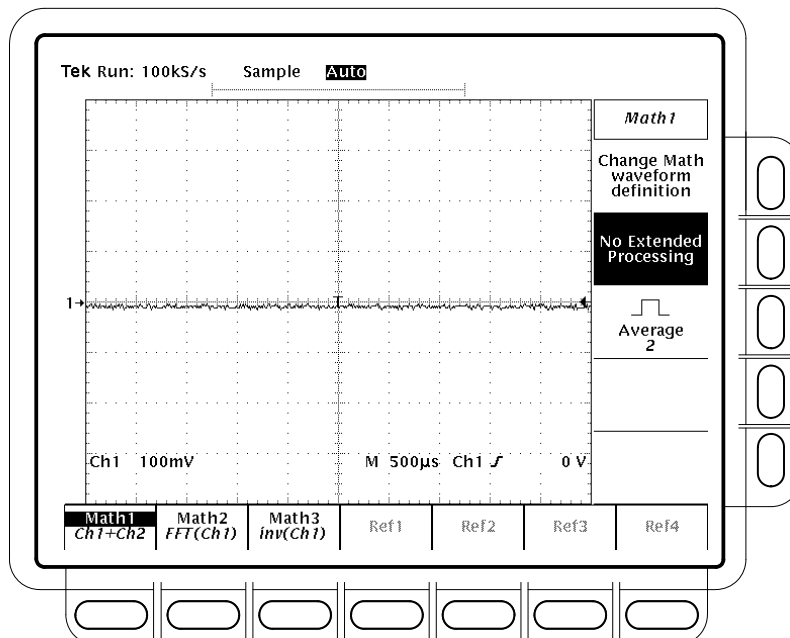

Figure 3–84: More Menu

3. Press **Set Function to** (side) repeatedly to cycle it to **inv** (invert), **intg**, or **diff**. Waveform integration (intg) is described on page 3–165, and waveform differentiation (diff) is described on page 3–161.
4. To create the math waveform, press **OK Create Math Wfm** (side).

To Use Dual Wfm Math

To create a math waveform that requires two waveform sources, do the following steps:

1. Press **MORE** → **Math1, Math2, or Math3** (main) → **Change Math waveform definition** (side) → **Dual Wfm Math** (main).
2. To define the first source waveform, press **Set 1st Source to** (side) repeatedly to cycle it to the desired channel or reference waveform.
3. To define the second source waveform, press **Set 2nd Source to** (side) repeatedly to cycle it to the desired channel or reference waveform.
4. To enter the math operator, press **Set operator to** (side) repeatedly to cycle it through the choices. Supported operators are +, −, * and /.

NOTE. If you select *, for multiply, in step 4, the cursor feature will measure amplitude in the units volts squared, VV , rather than in volts, V .

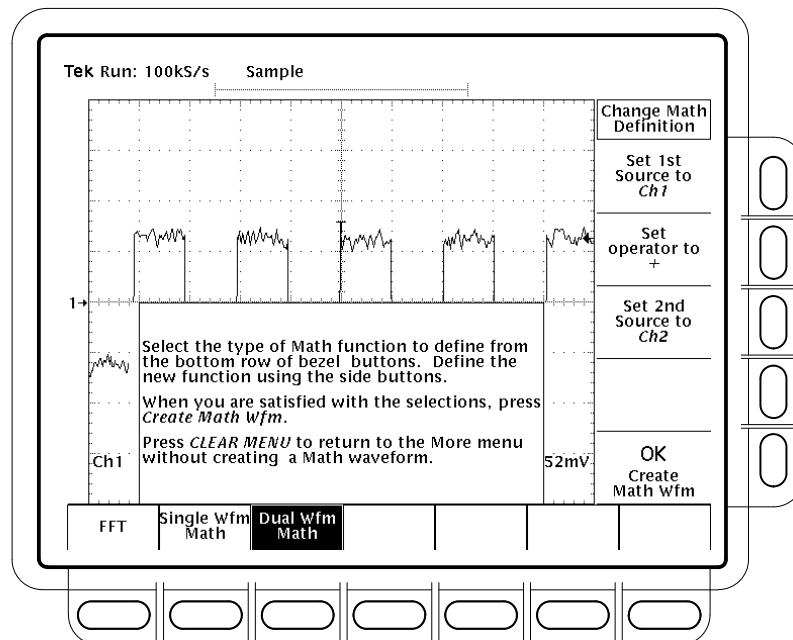

Figure 3–85: Dual Waveform Math Main and Side Menus

5. Press **OK Create Math Wfm** (side) to perform the function.

To Average a Math Waveform

You can also select whether or not you wish to average a certain math waveform; to do so, perform the following steps:

1. Press **MORE** → **Math1**, **Math2**, or **Math3** (main) to select the math waveform to be averaged.
2. Press **Average** (side) and enter a value with the general purpose knob or the keypad. Any math operations you select for the waveform are performed on an average of multiple acquisitions.
3. To turn off math averaging for the selected math waveform, press **No Extended Processing** (side). Any math operations you select for the waveform are performed on only one acquisition.

Fast Fourier Transforms

The Advanced DSP Math capabilities of the TDS Oscilloscope include taking the *Fast Fourier Transform (FFT)* of a waveform. This section describes FFTs and how to set up the oscilloscope to display and measure FFTs.

The FFT allows you to transform a waveform from a display of its amplitude against time to one that plots the amplitudes of the various discrete frequencies the waveform contains. Further, you can also display the phase shifts of those frequencies. Use FFT math waveforms in the following applications:

- Testing impulse response of filters and systems
- Measuring harmonic content and distortion in systems
- Characterizing the frequency content of DC power supplies
- Analyzing vibration
- Analyzing harmonics in 50 and 60 cycle lines
- Identifying noise sources in digital logic circuits

The FFT computes and displays the frequency content of a waveform you acquire as an FFT math waveform. This *frequency domain* waveform is based on the following equation:

$$X(k) = \frac{1}{N} \sum_{n = \frac{-N}{2}}^{\frac{N}{2} - 1} x(n)e^{-\frac{j2\pi nk}{N}} \quad \text{for } k = 0 \text{ to } N - 1$$

Where:

- x(n) is a point in the time domain record data array
- X(k) is a point in the frequency domain record data array
- n is the index to the time domain data array
- k is the index to the frequency domain data array
- N is the FFT length
- j is the square root of -1

The resulting waveform is a display of the magnitude or phase angle of the various frequencies the waveform contains with respect to those frequencies. For example, Figure 3-86 shows the untransformed impulse response of a system in channel 2 at the top of the screen. The FFT-transformed magnitude and phase appear in the two math waveforms below the impulse. The horizontal scale for FFT math waveforms is always expressed in frequency per division with the beginning (left-most point) of the waveform representing zero frequency (DC).

The FFT waveform is based on digital signal processing (DSP) of data, which allows more versatility in measuring the frequency content of waveforms. For example, DSP allows the oscilloscope to compute FFTs of source waveforms that must be acquired based on a single trigger, making it useful for measuring the frequency content of single events. DSP also allows the phase as well as the magnitude to be displayed.

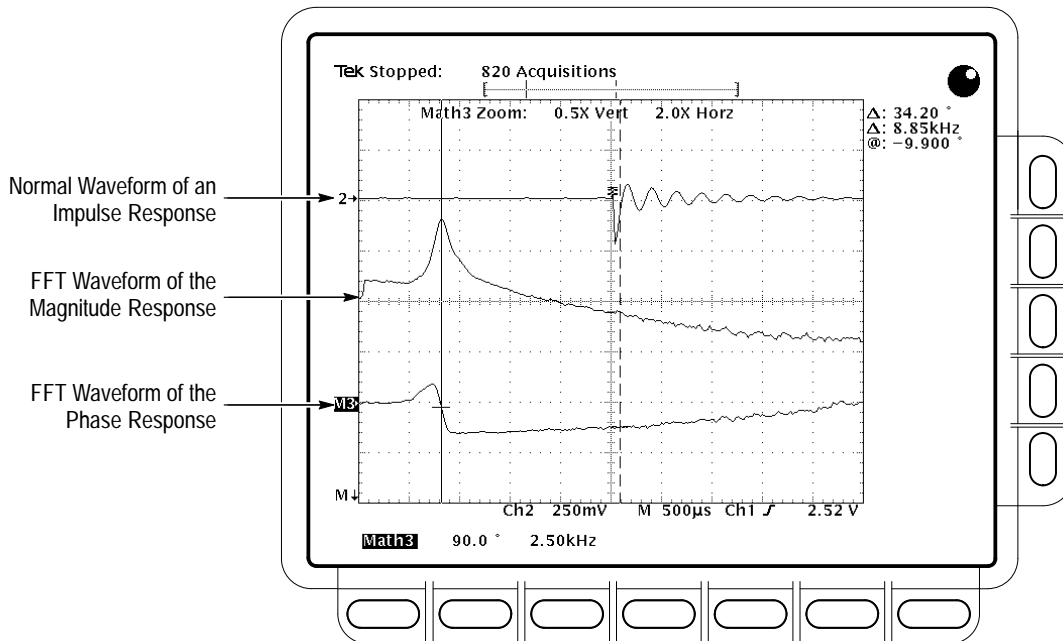

Figure 3-86: System Response to an Impulse

To Create an FFT

To obtain an FFT of your waveform, do the following steps:

1. Connect the waveform to the desired channel input and select that channel.
2. Adjust the vertical and horizontal scales and trigger the display (or press **AUTOSET**).

The topic *Offset, Position, and Scale*, on page 3-153, provides in depth information about optimizing your setup for FFT displays.

3. Press **MORE** to access the menu for turning on math waveforms.
4. Select a math waveform. Your choices are **Math1**, **Math2**, and **Math3** (main).
5. If the selected math waveform is not FFT, press **Change Math Definition** (side) → **FFT** (main). See Figure 3-87.
6. Press **Set FFT Source to** (side) repeatedly until the channel source selected in step 1 appears in the menu label.

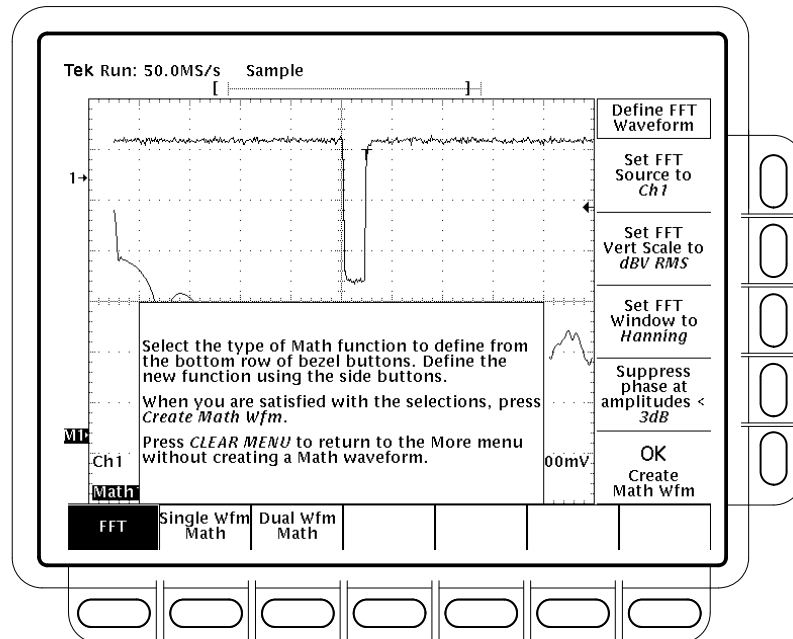

Figure 3–87: Define FFT Waveform Menu

7. Press **Set FFT Vert Scale to** (side) repeatedly to choose from the following vertical scale types:

dBV RMS — Magnitude is displayed using log scale, expressed in dB relative to $1 V_{RMS}$ where $0 \text{ dB} = 1 V_{RMS}$.

Linear RMS — Magnitude is displayed using voltage as the scale.

Phase (deg) — Phase is displayed using degrees as the scale, where degrees wrap from -180° to $+180^\circ$.

Phase (rad) — Phase is displayed using radians as the scale, where radians wrap from $-\pi$ to $+\pi$.

The topic *Considerations for Phase Displays*, on page 3–156, provides in depth information on setup for phase displays.

8. Press **Set FFT Window to** (side) repeatedly to choose from the following window types:

Rectangular — Best type of window for resolving frequencies that are very close to the same value but worst for accurately measuring the amplitude of those frequencies. Best type for measuring the frequency spectrum of nonrepetitive signals and measuring frequency components near DC.

Hamming — Very good window for resolving frequencies that are very close to the same value with somewhat improved amplitude accuracy over the rectangular window.

Hanning — Very good window for measuring amplitude accuracy but degraded for resolving frequencies.

Blackman-Harris — Best window for measuring the amplitude of frequencies but worst at resolving frequencies.

The topic *Selecting a Window*, on page 3–158, provides in depth information on choosing the right window for your application.

9. If you did not select **Phase (deg)** or **Phase (rad)** in step 7, skip to step 12. Phase suppression is only used to reduce noise in phase FFTs.
10. If you need to reduce the effect of noise in your phase FFT, press **Suppress phase at amplitudes < (side)**.
11. Use the general purpose knob to adjust the phase suppression level. FFT magnitudes below this level will have their phase set to zero.

The topic *Adjust Phase Suppression*, on page 3–157, provides additional information on phase suppression.

12. Press **OK Create Math Wfm (side)** to display the FFT of the waveform you input in step 1. (See Figure 3–88.)

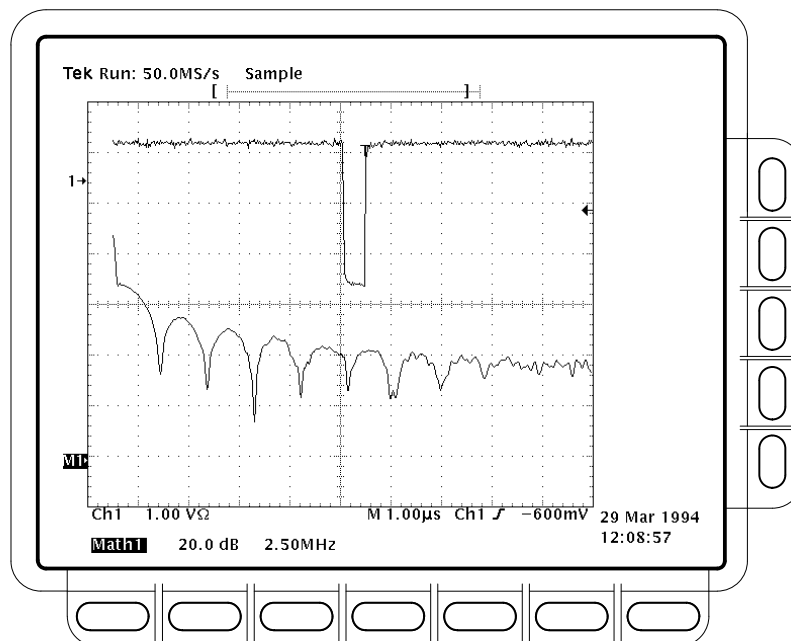

Figure 3–88: FFT Math Waveform in Math1

To Take Cursor Measurements of an FFT

Once you have displayed an FFT math waveform, use cursors to measure its frequency amplitude or phase angle.

1. Be sure **MORE** is selected in the channel selection buttons and that the FFT math waveform is selected in the **More** main menu.
2. Press **CURSOR** → **Mode** (main) → **Independent** (side) → **Function** (main) → **H Bars** (side).
3. Use the general purpose knob to align the selected cursor (solid line) to the top (or to any amplitude on the waveform you choose).
4. Press **SELECT** to select the other cursor. Use the general purpose knob to align the selected cursor to the bottom (or to any amplitude on the waveform you choose).
5. Read the amplitude between the two cursors from the **Δ**: readout. Read the amplitude of the selected cursor relative to either $1 V_{RMS}$ (0 dB), ground (0 volts), or the zero phase level (0 degrees or 0 radians) from the **@**: readout. (The waveform reference indicator at the left side of the graticule indicates the level where phase is zero for phase FFTs.)

Figure 3–89 shows the cursor measurement of a frequency magnitude on an FFT. The **@**: readout reads 0 dB because it is aligned with the $1 V_{RMS}$ level. The **Δ**: readout reads 24.4 dB indicating the magnitude of the frequency it is measuring is -24.4 dB relative to $1 V_{RMS}$. The source waveform is turned off in the display.

The cursor units will be in dB or volts for FFTs measuring magnitude and in degrees or radians for those FFTs measuring phase. The cursor unit depends on the selection made for Set FFT Vert Scale to (side). See step 7 on page 3–147 for more information.

6. Press **V Bars** (side). Use the general purpose knob to align one of the two vertical cursors to a point of interest along the horizontal axis of the waveform.
7. Press **SELECT** to select the alternate cursor.
8. Align the selected cursor to another point of interest on the math waveform.
9. Read the frequency difference between the cursors from the **Δ**: readout. Read the frequency of the selected cursor relative to the zero frequency point from the **@**: readout.

The cursor units will always be in Hz, regardless of the setting in the Time Units side menu. The first point of the FFT record is the zero frequency point for the **@**: readout.

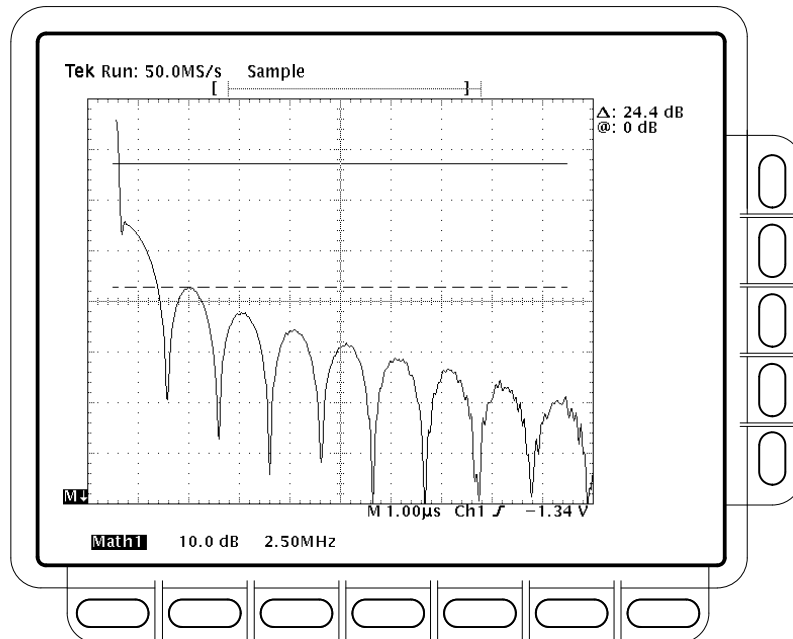

Figure 3-89: Cursor Measurement of an FFT Waveform

10. Press **Function** (main) → **Paired** (side).
11. Use the technique just outlined to place the vertical bar of each paired cursor to the points along the horizontal axis you are interested in.
12. Read the amplitude between the X of the two paired cursors from the top-most **Δ**: readout. Read the amplitude of the short horizontal bar of the selected (solid) cursor relative to either $1 V_{RMS}$ (0 dB), ground (0 volts), or zero phase level (0 degrees or 0 radians) from the **@**: readout. Read the frequency between the long horizontal bars of both paired cursors from the bottom **Δ**: readout.

To Take Automated Measurements of an FFT

You can use automated measurements to measure FFT math waveforms. Use the procedure *To Take Automated Measurements* found in *Waveform Differentiation* on page 3-163.

The FFT Frequency Domain Record

There are several characteristics of FFTs that affect how they are displayed and should be interpreted. Read this topic to learn about the FFT frequency domain record — how the source waveform relates to the record length, frequency resolution, and frequency range of that record. (The FFT frequency domain waveform is the FFT math waveform that you display.) Continue reading the topics that follow to learn how to optimize the oscilloscope setup for good display of your FFT waveforms.

FFTs May Not Use All of the Waveform Record. The *FFT math waveform* is a display of the magnitude or phase data from the *FFT frequency domain record*. This frequency domain record is derived from the FFT time domain record, which is derived from the *waveform record*. All three records are described below.

Waveform Record — the complete waveform record acquired from an input channel and displayed from the same channel or a reference memory. The length of this *time domain* record is user-specified from the Horizontal menu. The waveform record is not a DSP Math waveform.

FFT Time Domain Record — that part of the waveform record input to the FFT. This time domain record waveform becomes the FFT math waveform after it's transformed. Its record length depends on the length of the waveform record defined above.

FFT Frequency Domain Record — the FFT math waveform after digital signal processing converts data from the FFT time domain record into a frequency domain record.

Figure 3–90 compares the waveform record to the FFT time domain record. Note the following relationships:

- For waveform records ≤ 10 K points in length, the FFT uses all of the waveform record as input.
- For waveform records > 10 K points, the first 10 K points of the waveform record becomes the FFT time domain record.
- Each FFT time domain record starts at the beginning of the acquired waveform record.
- The zero phase reference point for a phase FFT math waveform is in the middle of the FFT time domain record regardless of the waveform record length.

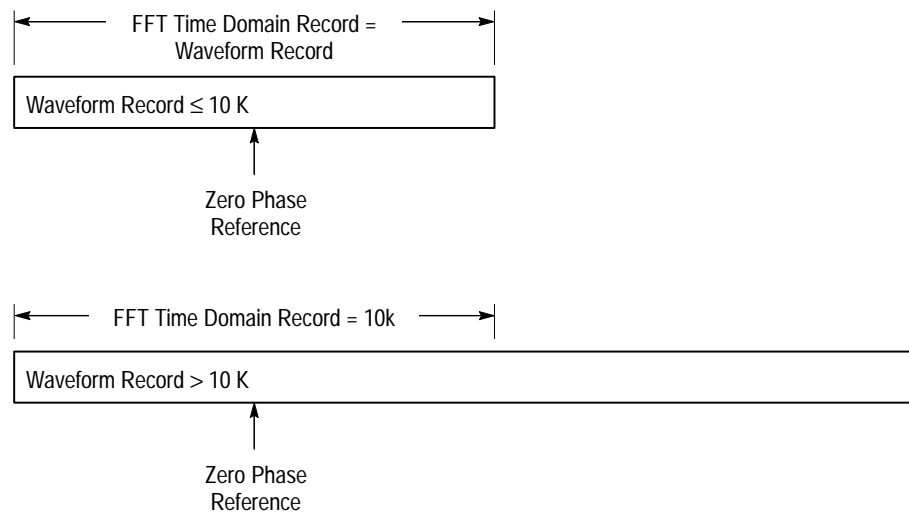

Figure 3–90: Waveform Record vs. FFT Time Domain Record

FFTs Transform Time Records to Frequency Records. The FFT time domain record just described is input for the FFT. Figure 3–91 shows the transformation of that time domain data record into an FFT frequency domain record. The resulting frequency domain record is one half the length of the FFT input because the FFT computes both positive and negative frequencies. Since the negative values mirror the positive values, only the positive values are displayed.

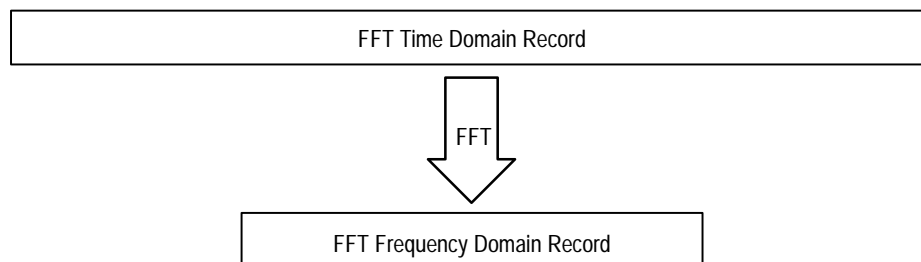

Figure 3–91: FFT Time Domain Record vs. FFT Frequency Domain Record

FFT Frequency Range and Resolution. When you turn on an FFT waveform, the oscilloscope displays either the magnitude or phase angle of the FFT frequency domain record. The resolution between the discrete frequencies displayed in this waveform is determined by the following equation:

$$\Delta F = \frac{\text{Sample Rate}}{\text{FFT Length}}$$

Where: ΔF is the frequency resolution.

Sample Rate is the sample rate of the source waveform.

FFT Length is the length of the FFT Time Domain waveform record.

The sample rate also determines the range these frequencies span; they span from 0 to $\frac{1}{2}$ the sample rate of the waveform record. (The value of $\frac{1}{2}$ the sample rate is often referred to as the Nyquist frequency or point.) For example, a sample rate of 20 Megasamples per second would yield an FFT with a range of 0 to 10 MHz. The sample rates available for acquiring data records vary over a range. TDS oscilloscopes display the sample rate in the acquisition readout at the top of the oscilloscope screen.

Offset, Position, and Scale

The following topics contain information to help you display your FFT properly.

Adjust for a Non-Clipped Display. To properly display your FFT waveform, scale the source waveform so it is not clipped.

- You should scale and position the source waveform so it is contained on screen. (Off screen waveforms may be clipped, resulting in errors in the FFT waveform).

Alternately, to get maximum vertical resolution, you can display source waveforms with amplitudes up to two divisions greater than that of the screen. If you do, turn on **Pk-Pk** in the measurement menu and monitor the source waveform for clipping.

- Use vertical position and vertical offset to position your *source* waveform. As long as the source waveform is not clipped, its vertical position and vertical offset will not affect your FFT waveform except at DC. (DC correction is discussed below.)

Adjust Offset and Position to Zero for DC Correction. Normally, the output of a standard FFT computation yields a DC value that is twice as large as it should be with respect to the other frequencies. Also, the selection of window type introduces errors in the DC value of an FFT.

The displayed output of the FFT on TDS oscilloscopes is corrected for these errors to show the true value for the DC component of the input signal. The Position and Offset must be set to zero for the source waveform in the Vertical menu. When measuring the amplitude at DC, remember that 1 VDC equals 1 V_{RMS} and the display is in dB.

Record Length

Most often, you will want to use a short record length because more of the FFT waveform can be seen on screen and long record lengths can slow oscilloscope response. However, long record lengths lower the noise relative to the signal and increase the frequency resolution for the FFT. More important, they might be needed to capture the waveform feature you want to include in the FFT.

To speed up oscilloscope response when using long record lengths, you can save your source waveform in a reference memory and perform an FFT on the saved waveform. That way the DSP will compute the FFT based on saved, static data and will only update if you save a new waveform.

Acquisition Mode

Selecting the right acquisition mode can produce less noisy FFTs.

Set up in Sample. Use sample mode until you have set up and turned on your FFT. Sample mode can acquire repetitive and nonrepetitive waveforms and does not affect the frequency response of the source waveform.

Hi Res and Average Reduce Noise. If the pulse is repetitive, Average mode may be used to reduce noise in the signal at a cost of slower display response. Average operates on repetitive waveforms only, and averaging does affect the frequency response of the source waveform.

For TDS 700A models only, after the FFT is set up and displayed, you can to turn on Hi Res mode to reduce the effect of noise in the signal. Hi Res operates on both repetitive and nonrepetitive waveforms; however, it does affect the frequency response of the source waveform.

Peak Detect and Envelope Add Distortion. Peak Detect (TDS 700A models) and Envelope mode can add significant distortion to the FFT results and are not recommended for use with FFTs.

Zoom and Interpolation

Once you have your waveform displayed optimally, you may magnify (or reduce) it vertically and horizontally to inspect any feature you desire. Just be sure the FFT waveform is the selected waveform. (Press **MORE**, then select the FFT waveform in the More main menu. Then use the Vertical and Horizontal **SCALE** knobs to adjust the math waveform size.)

If you wish to see the zoom factor (2X, 5X, etc.) you need to turn Zoom on: press **ZOOM → On** (side). The vertical and horizontal zoom factors appear on screen.

Whether Zoom is on or off, you can press **Reset Zoom Factors** (side) to return the zoomed FFT waveform to no magnification.

Zoom always uses either $\sin(x)/x$ or linear interpolation when expanding displayed waveforms. To select the interpolation method: press **DISPLAY → Setting** (main) → **Display** (pop-up) → **Filter** (main) → **Sin(x)/x** or **Linear** (side).

If the source waveform record length is 500 points, the FFT will use 2X Zoom to increase the 250 point FFT frequency domain record to 500 points. Therefore, FFT math waveforms of 500 point waveforms are always zoomed 2X or more with interpolation. Waveforms with other record lengths can be zoomed or not and can have minimum Zooms of 1X or less.

$\text{Sin}(x)/x$ interpolation may distort the magnitude and phase displays of the FFT depending on which window was used. You can easily check the effects of the interpolation by switching between $\text{sin}(x)/x$ and linear interpolation and observing the difference in measurement results on the display. If significant differences occur, use linear interpolation.

Undersampling (Aliasing)

Aliasing occurs when the oscilloscope acquires a source waveform with frequency components outside of the frequency range for the current sample rate. In the FFT waveform, the actual higher frequency components are under-sampled, and therefore, they appear as lower frequency aliases that “fold back” around the Nyquist point. (See Figure 3–92.)

The greatest frequency that can be input into any sampler without aliasing is $\frac{1}{2}$ the sample frequency. Since source waveforms often have a fundamental frequency that does not alias but have harmonic frequencies that do, you should have methods for recognizing and dealing with aliases:

- Be aware that a source waveform with fast edge transition times creates many high frequency harmonics. These harmonics typically decrease in amplitude as their frequency increases.
- Sample the source signal at rates that are at least 2X that of the highest frequency component having significant amplitude.
- Filter the input to bandwidth limit it to frequencies below that of the Nyquist frequency.
- Recognize and ignore the aliased frequencies.

If you think you have aliased frequencies in your FFT, select the source channel and adjust the horizontal scale to increase the sample rate. Since you increase the Nyquist frequency as you increase the sample rate, the alias signals should appear at their proper frequency.

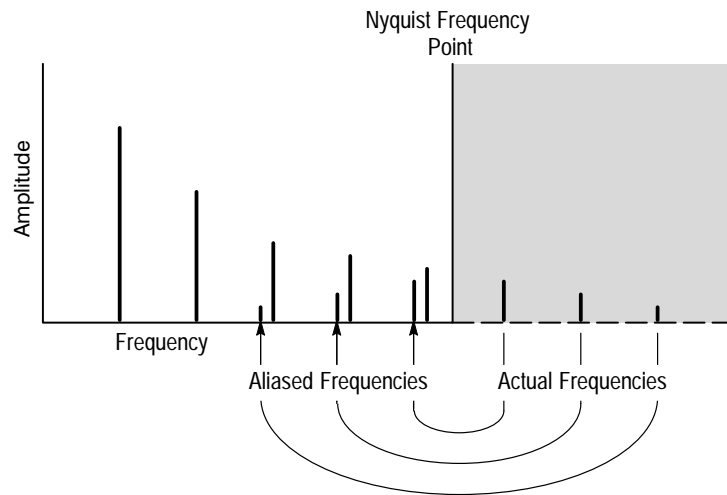

Figure 3-92: How Aliased Frequencies Appear in an FFT

Considerations for Phase Displays

When you set up an FFT math waveform to display the phase angle of the frequencies contained in a waveform, you should take into account the reference point the phase is measured against. You may also need to use phase suppression to reduce noise in your FFTs.

Establish a Zero Phase Reference Point. The phase of each frequency is measured with respect to the zero phase reference point. The zero reference point is the point at the center of the FFT math waveform but corresponds to various points on the *source* (time domain) record. (See Figure 3-90 on page 3-151.)

To measure the phase relative to most source waveforms, you need only to center the positive peak around the zero phase point. (For instance, center the positive half cycle for a sine or square wave around the zero phase point.) Use the following method:

- First be sure the FFT math waveform is selected in the More menu, then set horizontal position to 50% in the Horizontal menu. This positions the zero phase reference point to the horizontal center of the screen.
- In the Horizontal menu, vary the trigger position to center the positive peak of the source waveform at the horizontal center of screen. Alternately, you can adjust the trigger level (knob) to bring the positive peak to center screen if the phase reference waveform has slow enough edges.

When impulse testing and measuring phase, align the impulse input into the system to the zero reference point of the FFT time domain waveform:

- Set the trigger position to 50% and horizontal position to 50% for all record lengths less than 15 K.

- For records with a 100 K length (TDS 700A models with Option 1M only), set the trigger position to 5%. Use the horizontal position knob to move the trigger T on screen to the center horizontal graticule line.
- Do not use the 15 K (all models), 30 K (TDS 700A models), 75 K, or 130 K (TDS 700A models equipped with Option 1M) to impulse test using FFTs. These record lengths do not allow easy alignment of the zero reference point for phase measurements.
- Trigger on the input impulse.

Adjust Phase Suppression. Your source waveform record may have a noise component with phase angles that randomly vary from $-\pi$ to π . This noise could make the phase display unusable. In such a case, use phase suppression to control the noise.

You specify the phase suppression level in dB with respect to $1 V_{RMS}$. If the magnitude of the frequency is greater than this threshold, then its phase angle will be displayed. However, if it is less than this threshold, then the phase angle will be set to zero and be displayed as zero degrees or radians. (The waveform reference indicator at the left side of the graticule indicates the level where phase is zero for phase FFTs.)

It is easier to determine the level of phase suppression you need if you first create a *frequency* FFT math waveform of the source and then create a *phase* FFT waveform of the same source. Do the following steps to use a cursor measurement to determine the suppression level:

1. Do steps 1 through 7 of *To Create an FFT* that begins on page 3–146. Select **dBV RMS** (side) for the **Set FFT Vert Scale to** (side).
2. Press **CURSOR** → **Mode** (main) → **Independent** (side) → **Function** (main) → **H Bars** (side). Use the general purpose knob to align the selected cursor to a level that places the tops of the magnitudes of frequencies of interest above the cursor but places other magnitudes completely below the cursor.
3. Read the level in dB from the @: readout. Note the level for use in step 5.
4. Press **MORE** (main) → **Change Waveform Definition menu** (side). Press **Set FFT Vert Scale to** (side) repeatedly to choose either **Phase (rad)** or **Phase (deg)**.
5. Press **Suppress Phase at Amplitudes** (side). Use the general purpose knob to set phase suppression to the value obtained using the H Bar cursor. Do not change the window selection or you will invalidate the results obtained using the cursor.

FFT Windows To learn how to optimize your display of FFT data, read about how the FFT windows data before computing the FFT math waveform. Understanding FFT windowing can help you get more useful displays.

Windowing Process. The oscilloscope multiplies the FFT time domain record by one of four FFT windows before it inputs the record to the FFT function. Figure 3-93 shows how the time domain record is processed.

The FFT windowing acts like a bandpass filter between the FFT time domain record and the FFT frequency domain record. The shape of the window controls the ability of the FFT to resolve (separate) the frequencies and to accurately measure the amplitude of those frequencies.

Selecting a Window. You can select your window to provide better frequency resolution at the expense of better amplitude measurement accuracy in your FFT, better amplitude accuracy over frequency resolution, or to provide a compromise between both. You can choose from these four windows: Rectangular, Hamming, Hanning, and Blackman-Harris.

In step 8 (page 3-147) in *To Create an FFT*, the four windows are listed in order according to their ability to resolve frequencies versus their ability to accurately measure the amplitude of those frequencies. The list indicates that the ability of a given window to resolve a frequency is inversely proportional to its ability to accurately measure the amplitude of that frequency. In general, then, choose a window that can just resolve between the frequencies you want to measure. That way, you will have the best amplitude accuracy and leakage elimination while still separating the frequencies.

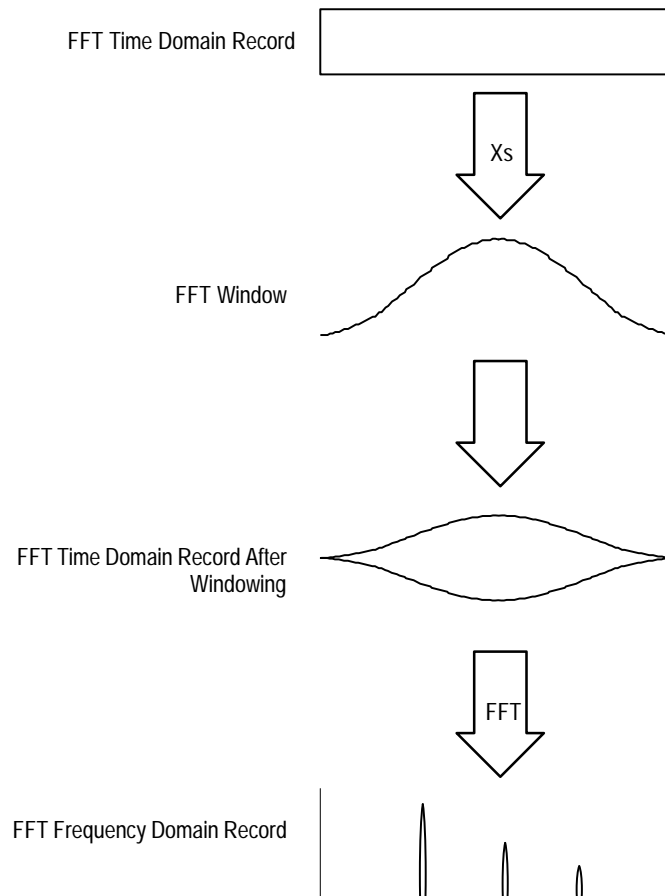

Figure 3–93: Windowing the FFT Time Domain Record

You can often determine the best window empirically by first using the window with the most frequency resolution (rectangular), then proceeding toward that window with the least (Blackman-Harris) until the frequencies merge. Use the window just before the window that lets the frequencies merge for best compromise between resolution and amplitude accuracy.

NOTE. *If the Hanning window merges the frequencies, try the Hamming window before settling on the rectangular window. Depending on the distance of the frequencies you are trying to measure from the fundamental, the Hamming window sometimes resolves frequencies better than the Hanning.*

Window Characteristics. When evaluating a window for use, you may want to examine how it modifies the FFT time domain data. Figure 3–94 shows each window, its bandpass characteristic, bandwidth, and highest side lobe. Consider the following characteristics:

- The narrower the central lobe for a given window, the better it can resolve a frequency.
- The lower the lobes on the side of each central lobe are, the better the amplitude accuracy of the frequency measured in the FFT using that window.
- Narrow lobes increase frequency resolution because they are more selective. Lower side lobe amplitudes increases accuracy because they reduce leakage.

Leakage results when the time domain waveform delivered to the FFT function contains a non-integer number of waveform cycles. Since there are fractions of cycles in such records, there are discontinuities at the ends of the record. These discontinuities cause energy from each discrete frequency to “leak” over on to adjacent frequencies. The result is amplitude error when measuring those frequencies.

The rectangular window does not modify the waveform record points; it generally gives the best frequency resolution because it results in the most narrow lobe width in the FFT output record. If the time domain records you measured always had an integer number of cycles, you would only need this window.

Hamming, Hanning, and Blackman-Harris are all somewhat bell-shaped windows that taper the waveform record at the record ends. The Hanning and Blackman/Harris windows taper the data at the end of the record to zero; therefore, they are generally better choices to eliminate leakage.







FFT Window Type	Bandpass Filter	-3 dB Bandwidth	Highest Side Lobe
 <p>Rectangular Window</p>		0.89	-13 dB
 <p>Hamming Window</p>		1.28	-43 dB
 <p>Hanning Window</p>		1.28	-32 dB
 <p>Blackman-Harris Window</p>		1.28	-94 dB

Figure 3-94: FFT Windows and Bandpass Characteristics

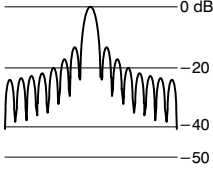
Care should be taken when using bell shaped windows to be sure that the most interesting parts of the signal in the time domain record are positioned in the center region of the window so that the tapering does not cause severe errors.

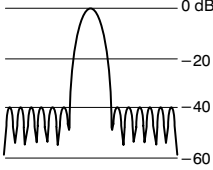
Waveform Differentiation

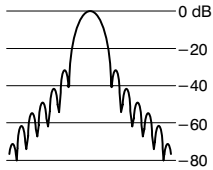
The Advanced DSP Math capabilities of the TDS Oscilloscope include *waveform differentiation*. This capability allows you to display a derivative math waveform that indicates the instantaneous rate of change of the waveform acquired. This section describes how to setup the oscilloscope to display and measure derivative math waveforms.

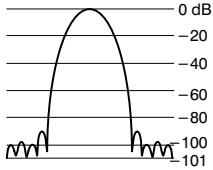
Derivative waveforms are used in the measurement of slew rate of amplifiers and in educational applications. You can store and display a derivative math waveform in a reference memory, then use it as a source for another derivative waveform. The result is the second derivative of the waveform that was first differentiated.

The math waveform, derived from the sampled waveform, is computed based on the following equation:

$$Y_n = (X_{(n+1)} - X_n) \frac{1}{T}$$

Where: X is the source waveform

Y is the derivative math waveform

T is the time between samples

Since the resultant math waveform is a derivative waveform, its vertical scale is in volts/second (its horizontal scale is in seconds). The source signal is differentiated over its entire record length; therefore, the math waveform record length equals that of the source waveform.

To Create a Derivative of a Waveform

To obtain a derivative math waveform:

1. Connect the waveform to the desired channel input and select that channel.
2. Adjust the vertical and horizontal scales and trigger the display (or press **AUTOSET**).
3. Press **MORE** → **Math1**, **Math2**, or **Math3** (main) → **Change Math Definition** (side) → **Single Wfm Math** (main). (See Figure 3–95).
4. Press **Set Single Source to** (side). Repeatedly press the same button (or use the general purpose knob) until the channel source selected in step 1 appears in the menu label.
5. Press **Set Function to** (side). Repeatedly press the same button (or use the general purpose knob) until **diff** appears in the menu label.
6. Press **OK Create Math Wfm** (side) to display the derivative of the waveform you input in step 1.

You should now have your derivative math waveform on screen. Use the Vertical **SCALE** and **POSITION** knobs to size and position your waveform as you require.

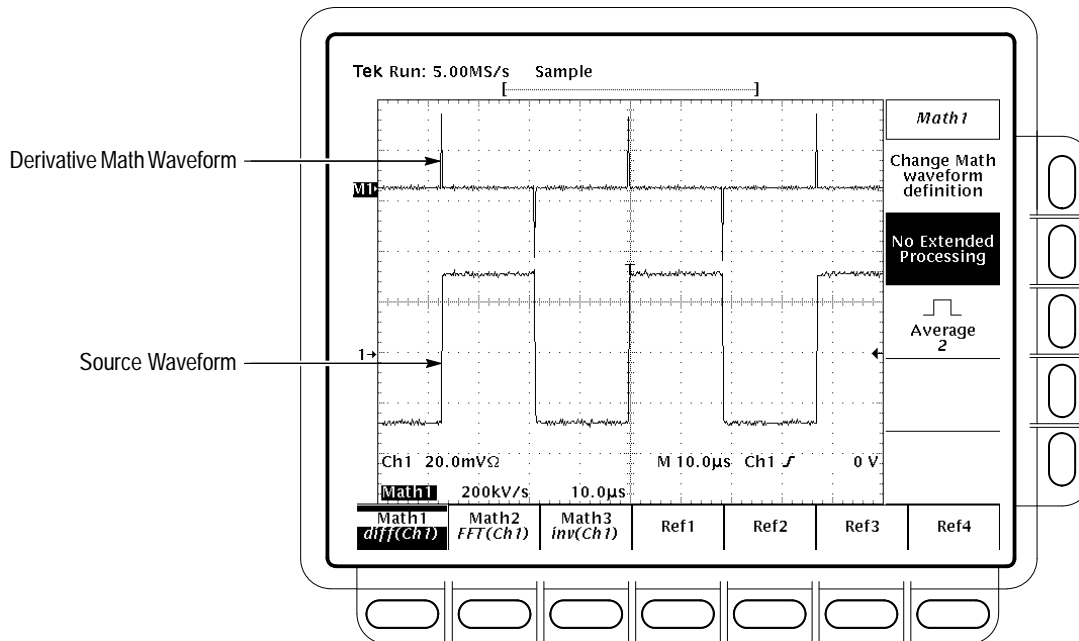

Figure 3-95: Derivative Math Waveform

To Take Automated Measurements

Once you have displayed your derivative math waveform, you can use automated measurements to make various parameter measurements. Do the following steps to display automated measurements of the waveform:

1. Be sure **MORE** is selected in the channel selection buttons and that the differentiated math waveform is selected in the **More** main menu.
2. Press **MEASURE** → **Select Measrmnt** (main).
3. Select up to four measurements in the side menu. (See Figure 3-96.)

To Take Cursor Measurements

You can also use cursors to measure derivative waveforms. Use the same procedure as is found under *To Take Cursor Measurements* on page 3-167. When using that procedure, note that the amplitude measurements on a derivative waveform will be in volts per second rather than in volt-seconds as is indicated for the integral waveform measured in the procedure.

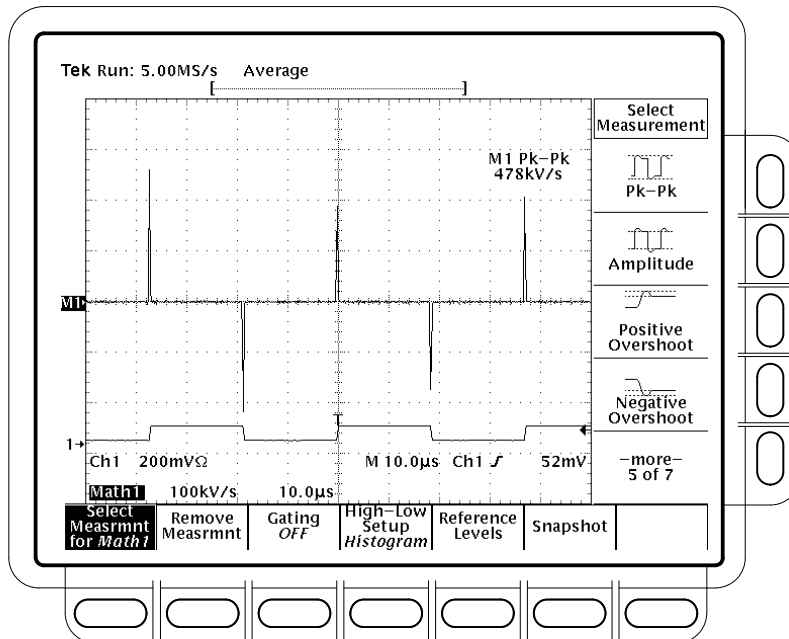

Figure 3-96: Peak-Peak Amplitude Measurement of a Derivative Waveform

Offset, Position, and Scale

The settings you make for offset, scale, and position affect the math waveform you obtain. Note the following tips for obtaining a good display:

- You should scale and position the source waveform so it is contained on screen. (Off screen waveforms may be clipped, resulting in errors in the derivative waveform).
- You can use vertical position and vertical offset to position your *source* waveform. The vertical position and vertical offset will not affect your derivative waveform unless you position the source waveform off screen so it is clipped.
- When using the vertical scale knob to scale the source waveform, note that it also scales your derivative waveform.

Because of the method the oscilloscope uses to scale the source waveform before differentiating that waveform, the derivative math waveform may be too large vertically to fit on screen — even if the source waveform is only a few divisions on screen. You can use Zoom to reduce the size of the waveform on screen (see *Zoom* that follows), but if your waveform is clipped before zooming, it will still be clipped after it is zoomed.

If your math waveform is a narrow differentiated pulse, it may not appear to be clipped when viewed on screen. You can detect if your derivative math waveform is clipped by expanding it horizontally using Zoom so you can see the

clipped portion. Also, the automated measurement Pk-Pk will display a clipping error message if turned on (see *To Take Automated Measurements* on page 3–163).

If your derivative waveform is clipped, try either of the following methods to eliminate clipping:

- Reduce the size of the source waveform on screen. (Select the source channel and use the vertical **SCALE** knob.)
- Expand the waveform horizontally on screen. (Select the source channel and increase the horizontal scale using the horizontal **SCALE** knob.) For instance, if you display the source waveform illustrated in Figure 3–95 on page 3–163 so its rising and falling edges are displayed over more horizontal divisions, the amplitude of the corresponding derivative pulse will decrease.

Whichever method you use, be sure **Zoom** is off and the zoom factors are reset (see *Using Zoom* below).

Using Zoom

Once you have your waveform optimally displayed, you can also magnify (or contract) it vertically and horizontally to inspect any feature. Just be sure the differentiated waveform is the selected waveform. (Press **MORE**, then select the differentiated waveform in the **More** main menu. Then use the Vertical and Horizontal **SCALE** knob to adjust the math waveform size.)

If you wish to see the zoom factor (2X, 5X, etc.), you need to turn zoom on: press **ZOOM → ON** (side). The vertical and horizontal zoom factors appear on screen.

Whether zoom is on or off, you can press **Reset Zoom Factors** (side) to return the zoomed derivative waveform to no magnification.

Waveform Integration

The Advanced DSP Math capabilities of the TDS Oscilloscope include *waveform integration*. This capability allows you to display an integral math waveform that is an integrated version of the acquired waveform. This section describes how to setup the oscilloscope to display and measure integral math waveforms.

Integral waveforms find use in the following applications:

- Measuring of power and energy, such as in switching power supplies
- Characterizing mechanical transducers, as when integrating the output of an accelerometer to obtain velocity

The integral math waveform, derived from the sampled waveform, is computed based on the following equation:

$$y(n) = scale \sum_{i=1}^n \frac{x(i) + x(i-1)}{2} T$$

Where:

- $x(i)$ is the source waveform
- $y(n)$ is a point in the integral math waveform
- scale is the output scale factor
- T is the time between samples

Since the resultant math waveform is an integral waveform, its vertical scale is in volt-seconds (its horizontal scale is in seconds). The source signal is integrated over its entire record length; therefore, the math waveform record length equals that of the source waveform.

To Create a Integral Math Waveform

To obtain an integral math waveform, do the following steps:

1. Connect the waveform to the desired channel input and select that channel.
2. Adjust the vertical and horizontal scales and trigger the display (or press **AUTOSET**).
3. Press **MORE** → **Math1**, **Math2**, or **Math3** (main) → **Change Math waveform definition** (side) → **Single Wfm Math** (main).
4. Press **Set Single Source to** (side). Repeatedly press the same button until the channel source selected in step 1 appears in the menu label.
5. Press **Set Function to** (side). Repeatedly press the same button until **intg** appears in the menu label.
6. Press **OK Create Math Waveform** (side) to turn on the integral math waveform.

You should now have your integral math waveform on screen. See Figure 3-97. Use the Vertical **SCALE** and **POSITION** knobs to size and position your waveform as you require.

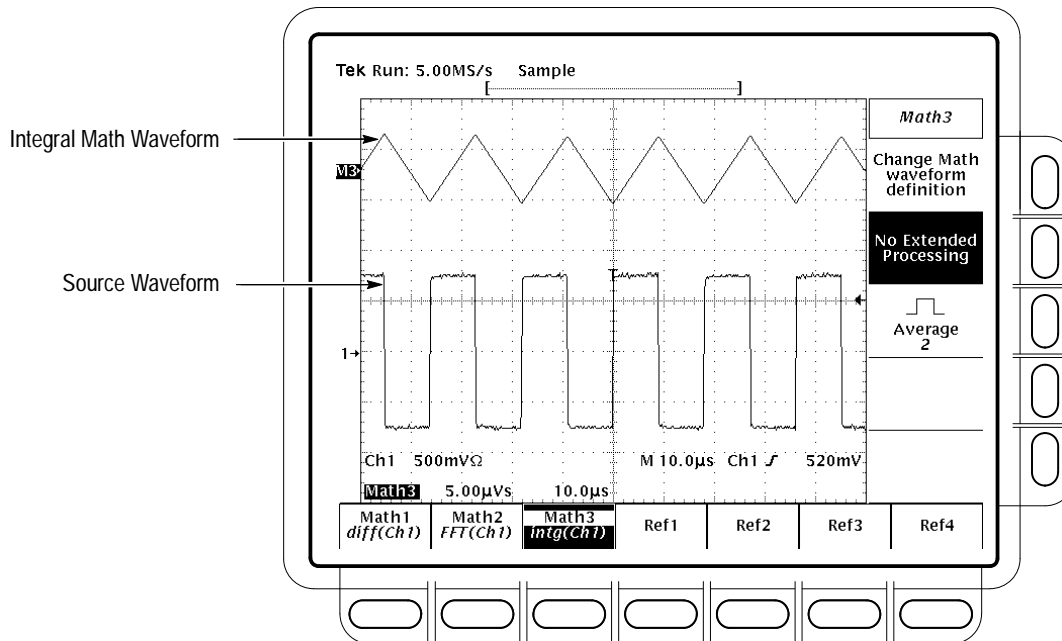

Figure 3-97: Integral Math Waveform

To Take Cursor Measurements

Once you have displayed your integrated math waveform, use cursors to measure its voltage over time.

1. Be sure **MORE** is selected (lighted) in the channel selection buttons and that the integrated math waveform is selected in the **More** main menu.
2. Press **CURSOR** → **Mode** (main) → **Independent** (side) → **Function** (main) → **H Bars** (side).
3. Use the general purpose knob to align the selected cursor (solid) to the top (or to any amplitude level you choose).
4. Press **SELECT** to select the other cursor.
5. Use the general purpose knob to align the selected cursor (to the bottom (or to any amplitude level you choose).
6. Read the integrated voltage over time between the cursors in volt-seconds from the **Δ**: readout. Read the integrated voltage over time between the selected cursor and the reference indicator of the math waveform from the **@**: readout. (See Figure 3-98.)

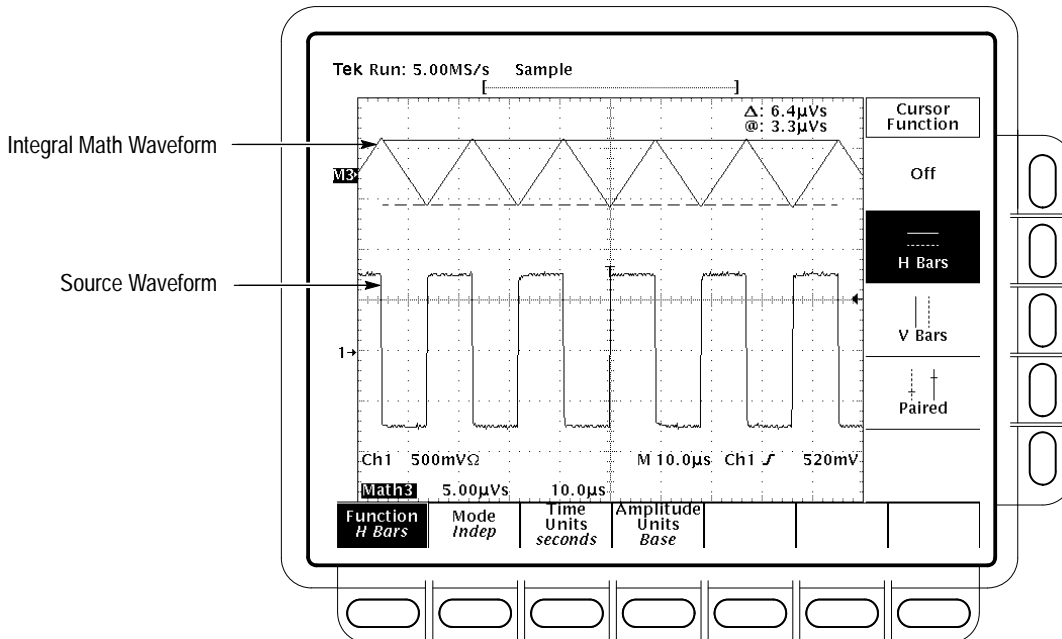

Figure 3-98: H Bars Cursors Measure an Integral Math Waveform

7. Press **Function** (main) → **V Bars** (side). Use the general purpose knob to align one of the two vertical cursors to a point of interest along the horizontal axis of the waveform.
8. Press **SELECT** to select the alternate cursor.
9. Align the alternate cursor to another point of interest on the math waveform.
10. Read the time difference between the cursors from the **Δ**: readout. Read the time difference between the selected cursor and the trigger point for the *source* waveform from the **@**: readout.
11. Press **Function** (main) → **Paired** (side).
12. Use the technique just outlined to place the long vertical bar of each paired cursor to the points along the horizontal axis you are interested in.
13. Read the following values from the cursor readouts:
 - Read the integrated voltage over time between the Xs of both paired cursors in volt-seconds from the **Δ**: readout.
 - Read the integrated voltage over time between the X of the selected cursor and the reference indicator of the math waveform from the **@**: readout.

- Read the time difference between the *long* vertical bars of the paired cursors from the **Δ**: readout.

To Take Automated Measurements

You can also use automated measurements to measure integral math waveforms. Use the same procedure as is found under *To Take Automated Measurements* on page 3–163. When using that procedure, note that your measurements on an integral waveform will be in volt-seconds rather than in volts per second as is indicated for the differential waveform measured in the procedure.

Offset, Position, and Scale

When creating integrated math waveforms from live channel waveforms, consider the following topics. Note the following requirements for obtaining a good display:

- You should scale and position the source waveform so it is contained on screen. (Off screen waveforms may be clipped, which will result in errors in the integral waveform).
- You can use vertical position and vertical offset to position your source waveform. The vertical position and vertical offset will not affect your integral waveform unless you position the source waveform off screen so it is clipped.
- When using the vertical scale knob to scale the source waveform, note that it also scales your integral waveform.

DC Offset

The source waveforms that you connect to the oscilloscope often have a DC offset component. The oscilloscope integrates this offset along with the time varying portions of your waveform. Even a few divisions of offset in the source waveform may be enough to ensure that the integral waveform saturates (clips), especially with long record lengths.

You may be able to avoid saturating your integral waveform if you choose a shorter record length. (Press **HORIZONTAL MENU** → **Record Length** (main).) Reducing the sample rate (use the **HORIZONTAL SCALE** knob) with the source channel selected might also prevent clipping. You can also select AC coupling in the vertical menu of the *source* waveform or otherwise DC filter it before applying it to the oscilloscope input.

Using Zoom

Once you have your waveform optimally displayed, you may magnify (or reduce) it vertically and horizontally to inspect any feature you desire. Just be sure the integrated waveform is the selected waveform. (Press **MORE**, then select the integrated waveform in the More main menu. Then use the Vertical and Horizontal **SCALE** knobs to adjust the math waveform size.)

If you wish to see the zoom factor (2X, 5X, etc.) you need to turn Zoom on: press **ZOOM → On** (side). The vertical and horizontal zoom factors appear on screen.

Whether Zoom is on or off, you can press **Reset Zoom Factors** (side) to return the zoomed integral waveform to no magnification.

Appendix A: Options and Accessories

This appendix describes the various options as well as the standard and optional accessories that are available for the TDS Oscilloscope.

Options

Tektronix will ship the options shown in Table A-1:

Table A-1: Options

	Option #	Label	Description
	A1	Universal European power cord	220 V, 50 Hz power cord
	A2	UK power cord	240 V, 50 Hz power cord
	A3	Australian power cord	240 V, 50 Hz power cord
	A4	North American power cord	240 V, 60 Hz power cord
	A5	Switzerland power cord	220 V, 50 Hz power cord
	05	Video trigger	Oscilloscope comes with tools for investigating events that occur when a video signal generates a horizontal or vertical sync pulse. It allow investigation of a range of NTSC, PAL, SECAM, and high definition TV signals.
	1K	Scope cart	K420 scope cart. This cart can help transport the oscilloscope around many lab environments.

Table A-1: Options (Cont.)



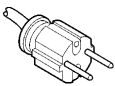
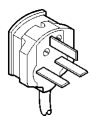
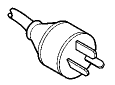
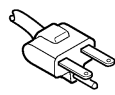
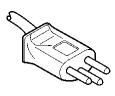
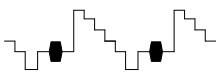
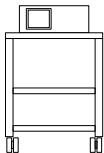

	Option #	Label	Description
	1M (TDS 7X4A)	130,000 record length (TDS 7X4A)	Extend TDS 7X4A record length from 50,000 standard to 500,000 samples on one channel, 250,000 on two channels, and 130,000 samples on three or four channels.
	1R	Rackmount	Oscilloscope comes configured for installation in a 19 inch wide instrument rack. For later field conversions, order kit # 016-1136-00.
	23 (TDS 7X4A)	Two active probes	Add two 750 MHz P6205 active probes
	24	Four passive probes	Add four 500 MHz P6139A passive probes
	26	Four active probes	Add four 1 GHz P6245 active probes
	2P	Color printer	Tektronix Phaser 200e, 300 dpi, thermal transfer, color printer. It handles letter or A4 size Tektronix thermal paper and transparencies. It can handle laser copy (plain) paper with the ColorCoat Transfer roll.

Table A-1: Options (Cont.)

	Option #	Label	Description
	95	Calibration Data Report	
	96	Calibration Certificate	Certificate of Calibration which states this instrument meets or exceeds all warranted specifications and has been calibrated using standards and instruments whose accuracies are traceable to the National Institute of Standards and Technology, an accepted value of a natural physical constant, or a ratio calibration technique. The calibration is in compliance with US MIL-STD-45662A. This option includes a test data report for the oscilloscope.

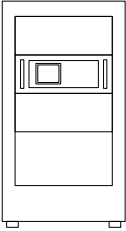
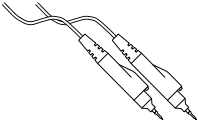
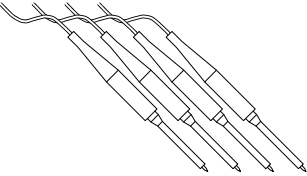
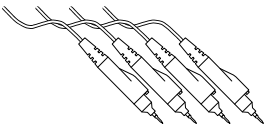
Standard Accessories

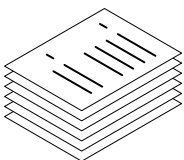
The oscilloscope comes standard with the accessories listed in Table A-2.

Table A-2: Standard Accessories

Accessory	Part Number
User Manual	070-8991-xx
Programmer Manual	070-8709-xx
Reference	070-8999-xx
Performance Verification	070-8990-xx
TDS 744A: Four P6139A 10X, 500 MHz Passive probes	P6139A
Front Cover	200-3696-00
Accessory Pouch	016-1268-00
U.S. Power Cord	161-0230-01

Optional Accessories

You can also order the optional accessories listed in Table A–3.

Table A–3: Optional Accessories

Accessory	Part Number
Service Manual	070-8992-xx
Plotter (GPIB and Centronics Standard)	HC100
Oscilloscope Cart	K420
Rack Mount Kit (for field conversion)	016-1236-00
Soft-Sided Carrying Case	016-0909-01
Transit Case	016-1135-00
GPIB Cable (1 meter)	012-0991-01
GPIB Cable (2 meter)	012-0991-00
Centronics Cable	012-1250-00

Accessory Probes

The following optional accessory probes are recommended for use with your oscilloscope:

- P6245 Active, high speed digital voltage probe. FET. DC to 1 GHz. 50 Ω input.
- P6101B 1X, 15 MHz, Passive probe.
- P6156 10X, 3.5 GHz, Passive, low capacitance, (low impedance Z_O) probe. Provides 100X, when ordered with Option 25.
- P6139A 10X, 500 MHz Passive probe.
- P6009 Passive, high voltage probe, 100X, 1500 VDC + Peak AC.
- P6015A Passive high voltage probe, 1000X, 20 kVDC + Peak AC (40 kV peak for less than 100 ms).
- P6217 Active, high speed digital voltage probe. FET. DC to 4 GHz. DC offset. 50 Ω input. Use with 1103 TekProbe Power Supply for offset control.
- P6204 Active, high speed digital voltage probe. FET. DC to 1 GHz. DC offset. 50 Ω input. Use with 1103 TekProbe Power Supply for offset control.
- P6563AS Passive, SMD probe, 20X, 500 MHz
- P6046 Active, differential probe, 1X/10X, DC to 100 MHz, 50 Ω input.

- AM 503S — DC/AC Current probe system, AC/DC. Uses A6302 Current Probe.
- AM 503S Option 03: DC/AC Current probe system, AC/DC. Uses A6303 Current Probe.
- P6021 AC Current probe. 120 Hz to 60 MHz.
- P6022 AC Current probe. 935 kHz to 120 MHz.
- CT-1 Current probe — designed for permanent or semi-permanent in-circuit installation. 25 kHz to 1 GHz, 50 Ω input.
- CT-2 Current probe — designed for permanent or semi-permanent in-circuit installation. 1.2 kHz to 200 MHz, 50 Ω input.
- CT-4 Current Transformer — for use with the AM 503S (A6302) and P6021. Peak pulse 1 kA. 0.5 Hz to 20 MHz with AM 503S (A6302).
- P6701A Opto-Electronic Converter, 500 to 950 nm, DC to 850 MHz, 1 V/mW.
- P6703A Opto-Electronic Converter, 1100 to 1700 nm, DC to 1 GHz, 1 V/mW.
- P6711 Opto-Electronic Converter, 500 to 950 nm, DC to 250 MHz, 5 V/mW.
- P6713 Opto-Electronic Converter, 1100 to 1700 nm, DC to 300 MHz, 5 V/mW.

Accessory Software

The optional accessories listed in Table A–4 are Tektronix software products recommended for use with your oscilloscope:

Table A–4: Accessory Software

Software	Part Number
Wavewriter: AWG and waveform creation	S3FT400
LabWindows	S3FG910

Warranty Information

Check for the full warranty statements for this product and the products listed above on the first page after the title page of each product manual.

Service Assurance

Tektronix offers the following services that you can purchase any time during the warranty period of this product:

- *REPXXXX* provides one year of post-warranty repair support. It is available in one year increments up to three years.

- *CALXXXX* provides one year of calibration support. It is available in one year increments up to five years.

Appendix B: Algorithms

The TDS Oscilloscope can take 25 automatic measurements. By knowing how it makes these calculations, you may better understand how to use your oscilloscope and how to interpret your results.

Measurement Variables

The oscilloscope uses a variety of variables in its calculations. These include:

High, Low *High* is the value used as the 100% level in measurements such as fall time and rise time. For example, if you request the 10% to 90% rise time, then the oscilloscope will calculate 10% and 90% as percentages with *High* representing 100%.

Low is the value used as the 0% level in measurements such as fall time and rise time.

The exact meaning of *High* and *Low* depends on which of two calculation methods you choose from the **High-Low Setup** item of the Measure menu. These are *Min-max* and *Histogram*.

Min-Max Method — defines the 0% and the 100% waveform levels as the lowest amplitude (most negative) and the highest amplitude (most positive) samples. The min-max method is useful for measuring frequency, width, and period for many types of signals. Min-max is sensitive to waveform ringing and spikes, however, and does not always measure accurately rise time, fall time, overshoot, and undershoot.

The min-max method calculates the High and Low values as follows:

$$High = Max$$

and

$$Low = Min$$

Histogram Method — attempts to find the highest density of points above and below the waveform midpoint. It attempts to ignore ringing and spikes when determining the 0% and 100% levels. This method works well when measuring square waves and pulse waveforms.

The oscilloscope calculates the histogram-based *High* and *Low* values as follows:

1. It makes a histogram of the record with one bin for each digitizing level (256 total).
2. It splits the histogram into two sections at the halfway point between *Min* and *Max* (also called *Mid*).
3. The level with the most points in the upper histogram is the *High* value, and the level with the most points in the lower histogram is the *Low* value. (Choose the levels where the histograms peak for *High* and *Low*.)

If *Mid* gives the largest peak value within the upper or lower histogram, then return the *Mid* value for both *High* and *Low* (this is probably a very low amplitude waveform).

If more than one histogram level (bin) has the maximum value, choose the bin farthest from *Mid*.

This algorithm does not work well for two-level waveforms with greater than about 100% overshoot.

HighRef, MidRef, LowRef, Mid2Ref

The user sets the various reference levels, through the **Reference Level** selection of the Measure menu. They include:

HighRef — the waveform high reference level. Used in fall time and rise time calculations. Typically set to 90%. You can set it from 0% to 100% or to a voltage level.

MidRef — the waveform middle reference level. Typically set to 50%. You can set it from 0% to 100% or to a voltage level.

LowRef — the waveform low reference level. Used in fall and rise time calculations. Typically set to 10%. You can set it from 0% to 100% or to a voltage level.

Mid2Ref — the middle reference level for a second waveform (or the second middle reference of the same waveform). Used in delay time calculations. Typically set to 50%. You can set it from 0% to 100% or to a voltage level.

Other Variables The oscilloscope also measures several values itself that it uses to help calculate measurements.

RecordLength — is the number of data points in the time base. You set it with the Horizontal menu **Record Length** item.

Start — is the location of the start of the measurement zone (X-value). It is 0.0 samples unless you are making a gated measurement. When you use gated measurements, it is the location of the left vertical cursor.

End — is the location of the end of the measurement zone (X-value). It is (*RecordLength* – 1.0) samples unless you are making a gated measurement. When you use gated measurements, it is the location of the right vertical cursor.

Hysteresis — The hysteresis band is 10% of the waveform amplitude. It is used in *MCross1*, *MCross2*, and *MCross3* calculations.

For example, once a crossing has been measured in a negative direction, the waveform data must fall below 10% of the amplitude from the *MidRef* point before the measurement system is armed and ready for a positive crossing. Similarly, after a positive *MidRef* crossing, waveform data must go above 10% of the amplitude before a negative crossing can be measured. Hysteresis is useful when you are measuring noisy signals, because it allows the oscilloscope to ignore minor fluctuations in the signal.

MCross Calculations **MCross1, MCross2, and MCross3** — refer to the first, second, and third *MidRef* cross times, respectively. (See Figure B–1.)

The polarity of the crossings does not matter for these variables, but the crossings alternate in polarity; that is, *MCross1* could be a positive or negative crossing, but if *MCross1* is a positive crossing, *MCross2* will be a negative crossing.

The oscilloscope calculates these values as follows:

1. Find the first *MidRefCrossing* in the waveform record or the gated region. This is *MCross1*.
2. Continuing from *MCross1*, find the next *MidRefCrossing* in the waveform record (or the gated region) of the opposite polarity of *MCross1*. This is *MCross2*.
3. Continuing from *MCross2*, find the next *MidRefCrossing* in the waveform record (or the gated region) of the same polarity as *MCross1*. This is *MCross3*.

MCross1Polarity — is the polarity of first crossing (no default). It can be rising or falling.

StartCycle — is the starting time for cycle measurements. It is a floating-point number with values between 0.0 and (*RecordLength* – 1.0), inclusive.

$$StartCycle = MCross1$$

EndCycle — is the ending time for cycle measurements. It is a floating-point number with values between 0.0 and (*RecordLength* – 1.0), inclusive.

$$EndCycle = MCross3$$

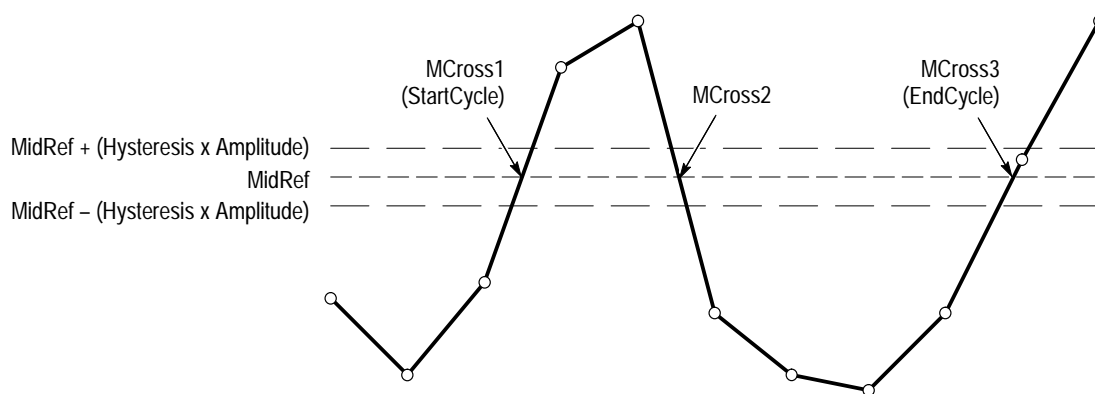

Figure B-1: MCross Calculations

Waveform[<0.0 ... RecordLength-1.0>] — holds the acquired data.

TPOS — is the location of the sample just before the trigger point (the time reference zero sample). In other terms, it contains the domain reference location. This location is where time = 0.

TSOFF — is the offset between *TPOS* and the actual trigger point. In other words, it is the trigger sample offset. Values range between 0.0 and 1.0 samples. This value is determined by the instrument when it receives a trigger. The actual zero reference (trigger) location in the measurement record is at (*TPOS*+*TSOFF*).

Measurement Algorithms

The automated measurements are defined and calculated as follows.

Amplitude $Amplitude = High - Low$



Area The arithmetic area for one waveform. Remember that one waveform is not necessarily equal to one cycle. For cyclical data you may prefer to use the cycle area rather than the arithmetic area.



if $Start = End$ then return the (interpolated) value at $Start$.

Otherwise,

$$Area = \int_{Start}^{End} Waveform(t) dt$$

For details of the integration algorithm, see page B-12.

Cycle Area Amplitude (voltage) measurement. The area over one waveform cycle. For data not cyclical, you might prefer to use the Area measurement.



If $StartCycle = EndCycle$ then return the (interpolated) value at $StartCycle$.

$$CycleMean = \int_{StartCycle}^{EndCycle} Waveform(t) dt$$

For details of the integration algorithm, see page B-12.

Burst Width Timing measurement. The duration of a burst.



1. Find $MCross1$ on the waveform. This is $MCrossStart$.
2. Find the last $MCross$ (begin the search at $EndCycle$ and search toward $StartCycle$). This is $MCrossStop$. This could be a different value from $MCross1$.
3. Compute $BurstWidth = MCrossStop - MCrossStart$

Cycle Mean



Amplitude (voltage) measurement. The mean over one waveform cycle. For non-cyclical data, you might prefer to use the Mean measurement.

If $StartCycle = EndCycle$ then return the (interpolated) value at $StartCycle$.

$$CycleMean = \frac{\int_{StartCycle}^{EndCycle} Waveform(t) dt}{(EndCycle - StartCycle) \times SampleInterval}$$

For details of the integration algorithm, see page B–12.

Cycle RMS



The true Root Mean Square voltage over one cycle.

If $StartCycle = EndCycle$ then $CycleRMS = Waveform[Start]$.

Otherwise,

$$CycleRMS = \sqrt{\frac{\int_{StartCycle}^{EndCycle} (Waveform(t))^2 dt}{(EndCycle - StartCycle) \times SampleInterval}}$$

For details of the integration algorithm, see page B–12.

Delay



Timing measurement. The amount of time between the *MidRef* and *Mid2Ref* crossings of two different traces, or two different places on the same trace.

Delay measurements are actually a group of measurements. To get a specific delay measurement, you must specify the target and reference crossing polarities and the reference search direction.

Delay = the time from one *MidRef* crossing on the source waveform to the *Mid2Ref* crossing on the second waveform.

Delay is not available in the Snapshot display.

Fall Time



Timing measurement. The time taken for the falling edge of a pulse to drop from a *HighRef* value (default = 90%) to a *LowRef* value (default = 10%).

Figure B–2 shows a falling edge with the two crossings necessary to calculate a Fall measurement.

1. Searching from *Start* to *End*, find the first sample in the measurement zone greater than *HighRef*.

2. From this sample, continue the search to find the first (negative) crossing of *HighRef*. The time of this crossing is *THF*. (Use linear interpolation if necessary.)
3. From *THF*, continue the search, looking for a crossing of *LowRef*. Update *THF* if subsequent *HighRef* crossings are found. When a *LowRef* crossing is found, it becomes *TLF*. (Use linear interpolation if necessary.)
4. $FallTime = TLF - THF$

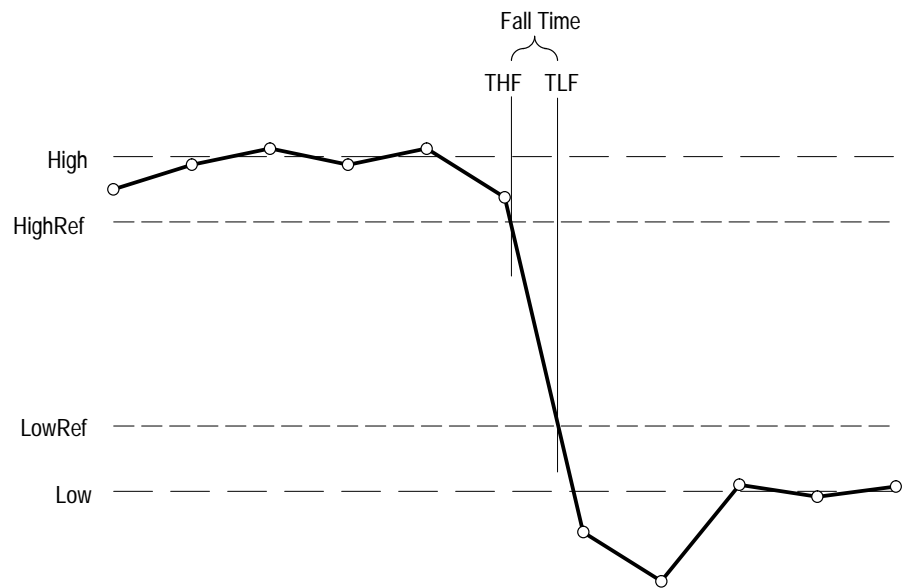









Figure B-2: Fall Time

<p>Frequency</p> 	<p>Timing measurement. The reciprocal of the period. Measured in Hertz (Hz) where 1 Hz = 1 cycle per second.</p> <p>If <i>Period</i> = 0 or is otherwise bad, return an error.</p> $Frequency = 1/Period$
<p>High</p> 	<p>100% (highest) voltage reference value. (See <i>High</i>, <i>Low</i> on page B-1.)</p> <p>Using the min-max measurement technique:</p> $High = Max$

	Low	0% (lowest) voltage reference value calculated. (See <i>High</i> , <i>Low</i> on page B-1.)
		Using the min-max measurement technique: $Low = Min$
	Maximum	Amplitude (voltage) measurement. The maximum voltage. Typically the most positive peak voltage. Examine all <i>Waveform[J]</i> samples from <i>Start</i> to <i>End</i> inclusive, and set <i>Max</i> equal to the greatest magnitude <i>Waveform[J]</i> value found.
	Mean	The arithmetic mean for one waveform. Remember that one waveform is not necessarily equal to one cycle. For cyclical data you may prefer to use the cycle mean rather than the arithmetic mean. If <i>Start</i> = <i>End</i> then return the (interpolated) value at <i>Start</i> . Otherwise, $Mean = \frac{\int_{Start}^{End} Waveform(t) dt}{(End - Start) \times SampleInterval}$
		For details of the integration algorithm, see page B-12.
	Minimum	Amplitude (voltage) measurement. The minimum amplitude. Typically the most negative peak voltage. Examine all <i>Waveform[J]</i> samples from <i>Start</i> to <i>End</i> inclusive, and set <i>Min</i> equal to the smallest magnitude <i>Waveform[J]</i> value found.
Negative Duty Cycle		Timing measurement. The ratio of the negative pulse width to the signal period expressed as a percentage. <i>NegativeWidth</i> is defined in Negative Width , below. If <i>Period</i> = 0 or undefined then return an error. $NegativeDutyCycle = \frac{NegativeWidth}{Period} \times 100\%$
	Negative Overshoot	Amplitude (voltage) measurement. $NegativeOvershoot = \frac{Low - Min}{Amplitude} \times 100\%$

Note that this value should never be negative (unless High or Low are set out-of-range).

Negative Width



Timing measurement. The distance (time) between *MidRef* (default = 50%) amplitude points of a negative pulse.

If *MCross1Polarity* = ‘-’

then

$$\text{NegativeWidth} = (\text{MCross2} - \text{MCross1})$$

else

$$\text{NegativeWidth} = (\text{MCross3} - \text{MCross2})$$

Peak to Peak



Amplitude measurement. The absolute difference between the maximum and minimum amplitude.

$$\text{PeaktoPeak} = \text{Max} - \text{Min}$$

Period



Timing measurement. Time taken for one complete signal cycle. The reciprocal of frequency. Measured in seconds.

$$\text{Period} = \text{MCross3} - \text{MCross1}$$

Phase



Timing measurement. The amount of phase shift, expressed in degrees of the target waveform cycle, between the *MidRef* crossings of two different waveforms. Waveforms measured should be of the same frequency or one waveform should be a harmonic of the other.

Phase is a dual waveform measurement; that is, it is measured from a target waveform to a reference waveform. To get a specific phase measurement, you must specify the target and reference sources.

Phase is determined in the following manner:

1. The first *MidRefCrossing* (*MCross1Target*) and third (*MCross3*) in the source (target) waveform are found.
2. The period of the target waveform is calculated (see *Period* above).
3. The first *MidRefCrossing* (*MCross1Ref*) in the reference waveform crossing in the same direction (polarity) as that found *MCross1Target* for the target waveform is found.
4. The phase is determined by the following:

$$Phase = \frac{MCross1Ref - MCross1Target}{Period} \times 360$$

If the target waveform leads the reference waveform, phase is positive; if it lags, negative.

Phase is not available in the Snapshot display.

Positive Duty Cycle



Timing measurement. The ratio of the positive pulse width to the signal period, expressed as a percentage.

PositiveWidth is defined in **Positive Width**, following.

If *Period* = 0 or undefined then return an error.

$$PositiveDutyCycle = \frac{PositiveWidth}{Period} \times 100\%$$

Positive Overshoot



Amplitude (voltage) measurement.

$$PositiveOvershoot = \frac{Max - High}{Amplitude} \times 100\%$$

Note that this value should never be negative.

Positive Width



Timing measurement. The distance (time) between *MidRef* (default = 50%) amplitude points of a positive pulse.

If *MCross1Polarity* = '+'

then

$$PositiveWidth = (MCross2 - MCross1)$$

else

$$PositiveWidth = (MCross3 - MCross2)$$

Rise Time



Timing measurement. Time taken for the leading edge of a pulse to rise from a *LowRef* value (default = 10%) to a *HighRef* value (default = 90%).

Figure B-3 shows a rising edge with the two crossings necessary to calculate a Rise Time measurement.

1. Searching from *Start* to *End*, find the first sample in the measurement zone less than *LowRef*.

2. From this sample, continue the search to find the first (positive) crossing of *LowRef*. The time of this crossing is the low rise time or *TLR*. (Use linear interpolation if necessary.)
3. From *TLR*, continue the search, looking for a crossing of *HighRef*. Update *TLR* if subsequent *LowRef* crossings are found. If a *HighRef* crossing is found, it becomes the high rise time or *THR*. (Use linear interpolation if necessary.)
4. $RiseTime = THR - TLR$

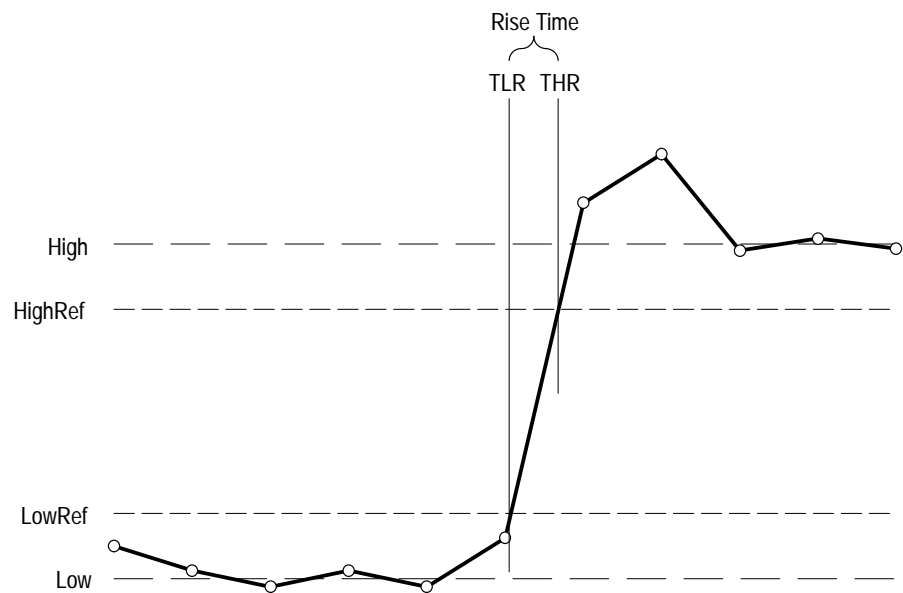

Figure B-3: Rise Time

RMS: Amplitude (voltage) measurement. The true Root Mean Square voltage.



If $Start = End$ then $RMS =$ the (interpolated) value at $Waveform[Start]$.

Otherwise,

$$RMS = \sqrt{\frac{\int_{Start}^{End} (Waveform(t))^2 dt}{(End - Start) \times SampleInterval}}$$

For details of the integration algorithm, see below.

Integration Algorithm

The integration algorithm used by the oscilloscope is as follows:

$$\int_A^B W(t)dt \text{ is approximated by } \int_A^B \hat{W}(t)dt \text{ where:}$$

$W(t)$ is the sampled waveform

$\hat{W}(t)$ is the continuous function obtained by linear interpolation of $W(t)$

A and B are numbers between 0.0 and $RecordLength-1.0$

If A and B are integers, then:

$$\int_A^B \hat{W}(t)dt = s \times \sum_{i=A}^{B-1} \frac{W(i) + W(i+1)}{2}$$

where s is the sample interval.

Similarly,

$$\int_A^B (W(t))^2 dt \text{ is approximated by } \int_A^B (\hat{W}(t))^2 dt \text{ where:}$$

$W(t)$ is the sampled waveform

$\hat{W}(t)$ is the continuous function obtained by linear interpolation of $W(t)$

A and B are numbers between 0.0 and $RecordLength-1.0$

If A and B are integers, then:

$$\int_A^B (\hat{W}(t))^2 dt = s \times \sum_{i=A}^{B-1} \frac{(W(i))^2 + W(i) \times W(i+1) + (W(i+1))^2}{3}$$

where s is the sample interval.

Measurements on Envelope Waveforms

Time measurements on envelope waveforms must be treated differently from time measurements on other waveforms, because envelope waveforms contain so many apparent crossings. Unless otherwise noted, envelope waveforms use either the minima or the maxima (but not both), determined in the following manner:

1. Step through the waveform from *Start* to *End* until the sample min and max pair *DO NOT* straddle *MidRef*.
2. If the pair $> MidRef$, use the minima, else use maxima.

If all pairs straddle *MidRef*, use maxima. See Figure B-4.

The Burst Width measurement always uses both maxima and minima to determine crossings.

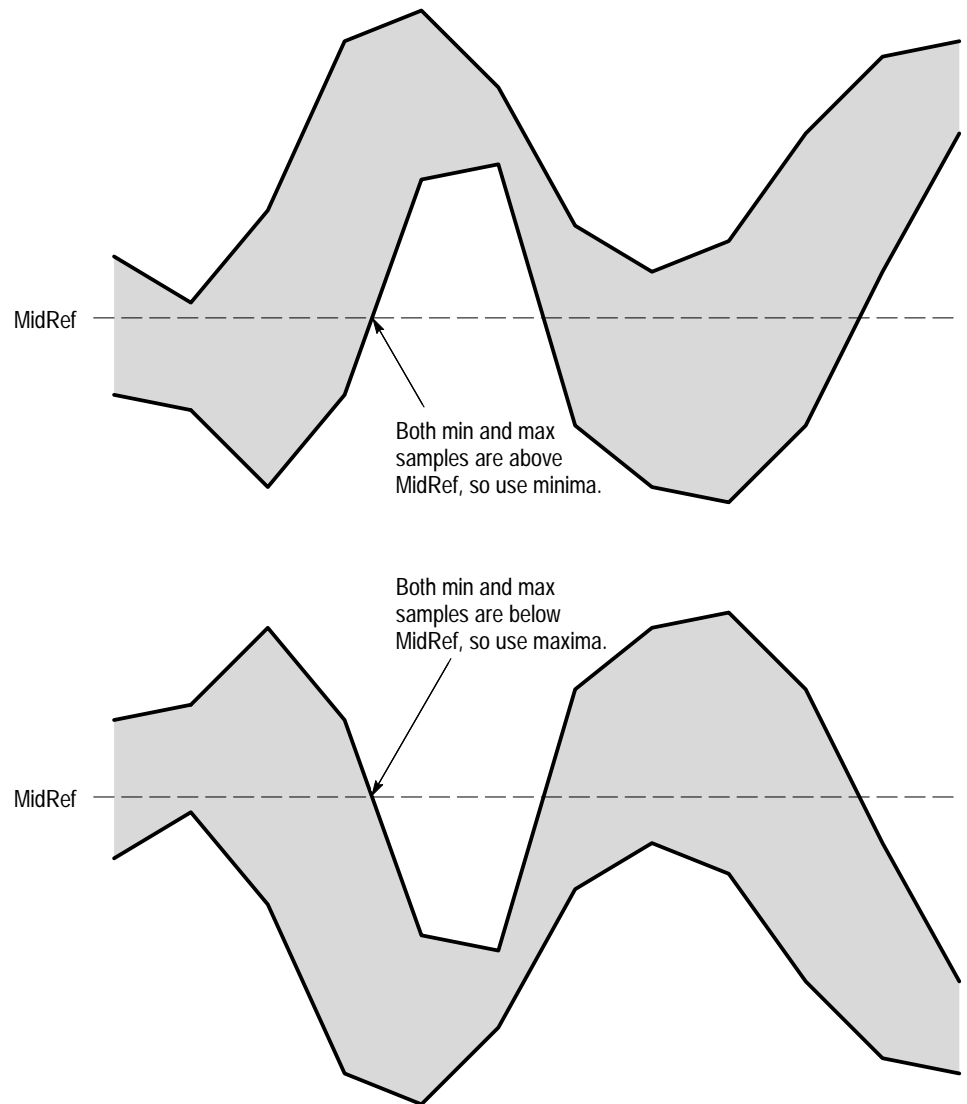

Figure B-4: Choosing Minima or Maxima to Use for Envelope Measurements

Missing or Out-of-Range Samples

If some samples in the waveform are missing or off-scale, the measurements will linearly interpolate between known samples to make an “appropriate” guess as to the sample value. Missing samples at the ends of the measurement record will be assumed to have the value of the nearest known sample.

When samples are out of range, the measurement will give a warning to that effect (for example, “CLIPPING”) if the measurement could change by extending the measurement range slightly. The algorithms assume the samples recover from an overdrive condition instantaneously.

For example, if *MidRef* is set directly, then *MidRef* would not change even if samples were out of range. However, if *MidRef* was chosen using the % choice from the **Set Levels in % Units** selection of the Measure menu, then *MidRef* could give a “CLIPPING” warning.

NOTE. *When measurements are displayed using Snapshot, out of range warnings are NOT available. However, if you question the validity of any measurement in the snapshot display, you can select and display the measurement individually and then check for a warning message.*

Appendix C: Packaging for Shipment

If you ship the TDS Oscilloscope, pack it in the original shipping carton and packing material. If the original packing material is not available, package the instrument as follows:

1. Obtain a corrugated cardboard shipping carton with inside dimensions at least 15 cm (6 in) taller, wider, and deeper than the oscilloscope. The shipping carton must be constructed of cardboard with 170 kg (375 pound) test strength.
2. If you are shipping the oscilloscope to a Tektronix field office for repair, attach a tag to the oscilloscope showing the instrument owner and address, the name of the person to contact about the instrument, the instrument type, and the serial number.
3. Wrap the oscilloscope with polyethylene sheeting or equivalent material to protect the finish.
4. Cushion the oscilloscope in the shipping carton by tightly packing dunnage or urethane foam on all sides between the carton and the oscilloscope. Allow 7.5 cm (3 in) on all sides, top, and bottom.
5. Seal the shipping carton with shipping tape or an industrial stapler.

***NOTE.** Do not ship the oscilloscope with a disk inside the disk drive. When the disk is inside the drive, the disk release button sticks out. This makes the button more prone to damage than otherwise.*

Appendix D: Factory Initialization Settings

Recalling the factory setup establishes the initialization settings shown in Table D-1 to set the TDS Oscilloscope to a known default state.

Table D-1: Factory Initialization Defaults

Control	Changed by Factory Init to
Acquire mode	Sample
Acquire repetitive signal (TDS 700A models only)	ON (Enable ET)
Acquire stop after	RUN/STOP button only
Acquire # of averages	16
Acquire # of envelopes	10
Channel selection	Channel 1 on, all others off
Cursor H Bar 1 position	10% of graticule height (-3.2 divs from the center)
Cursor H Bar 2 position	90% of the graticule height (+3.2 divs from the center)
Cursor V Bar 1 position	10% of the record length
Cursor V Bar 2 position	90% of the record length
Cursor amplitude units	Base
Cursor function	Off
Cursor mode	Independent
Cursor time units	Seconds
Date and time	No change
Delayed edge trigger coupling	Main Trigger
Delayed edge trigger level	0 V
Delayed edge trigger slope	Rising
Delayed edge trigger source	Channel 1
Delay trigger average #	16
Delay trigger envelope #	10
Delay events, triggerable after main	2
Delay time	16 ns
Delayed, delay by ...	Delay by Time
Delayed, time base mode	Delayed Runs After Main
Display clock	No Change

Table D-1: Factory Initialization Defaults (Cont.)

Control	Changed by Factory Init to
Display color – collision contrast	Off
Display color – map math colors	Color 'Math'
Display color – map reference colors	Color 'Ref'
Display color – palette	Normal
Display color – palette colors	The colors of each palette are reset to factory hue, saturation, and lightness (HLS) values
Display color – persistence palette	Temperature
Display format	YT
Display graticule type	Full
Display intensity – text	100%
Display intensity – waveform	100%
Display interpolation filter	Sin(x)/x
Display Mode (TDS 700A models only)	Normal (InstaVu acquisition off)
Display style	Vectors
Display trigger bar style	Short
Display trigger "T"	On
Display variable persistence	500 ms
Edge trigger coupling	DC
Edge trigger level	0.0 V
Edge trigger slope	Rising
Edge trigger source	Channel 1
GPIB parameters	No change
Hardcopy Format	Unchanged
Layout	Unchanged
Palette	Unchanged
Port	Unchanged
Horizontal – delay trigger position	50%
Horizontal – delay time/division	50 μ s
Horizontal – FastFrame (TDS 700A models only)	Off
Horizontal – FastFrame, frame count (TDS 700A models only)	2
Horizontal – FastFrame, frame length (TDS 700A models only)	500
Horizontal – fit to screen	Off

Table D-1: Factory Initialization Defaults (Cont.)

Control	Changed by Factory Init to
Horizontal – main time/division	500 μ s
Horizontal – main trigger position	50%
Horizontal – position	50%
Horizontal – record length	500 points (10 divs)
Horizontal – time base	Main only
Limit template \pm V Limit \pm H Limit	40 mdiv 40 mdiv
Limit template destination	Ref1
Limit template source	Ch1
Limit test sources	Ch1 compared to Ref1; all others compared to none.
Limit Testing	Off
Limit Testing – hardcopy if condition met	Off
Limit Testing – ring bell if condition met	Off
Logic pattern trigger Ch4 input	X (don't care)
Logic state trigger Ch4 input	Rising edge
Logic trigger class	Pattern
Logic trigger input (pattern and state)	Channel 1 = H (high), Channels 2 & 3 = X (don't care)
Logic trigger logic (pattern and state)	AND
Logic trigger pattern time qualification Lower limit Upper limit	5 ns 5 ns
Logic trigger Setup/Hold times Setup Hold	3 ns 2 ns
Logic trigger sources and levels (Setup/Hold)	Data Source = Channel 1 = 1.4 V Clock Source = Channel 2 = 1.4 V (Source levels are clipped to 1.2 V at the default volts/division setting established by Factory Init) Clock Edge = Rising
Logic trigger threshold (all channels) (pattern, state, and Setup/Hold)	1.4 V (clipped to 1.2 V at the default volts/division setting)

Table D-1: Factory Initialization Defaults (Cont.)

Control	Changed by Factory Init to
Logic trigger triggers when ... (pattern and state)	Goes TRUE
Main trigger holdoff time	Default Holdoff Selected: 5 horizontal divisions Holdoff Mode Selected: 250 ns
Main trigger holdoff mode	Default Holdoff
Main trigger mode	Auto
Main trigger type	Edge
Math1 definition	Ch 1 + Ch 2
Math1 extended processing	No extended processing
Math2 definition	FFT of Ch 1
Math2 extended processing	No extended processing
Math3 definition	Inv of Ch 1
Math3 extended processing	No extended processing
Measure Delay to	Channel 1 (Ch1)
Measure Delay edges	Both rising and forward searching
Measure Gating	Off
Measure High-Low Setup	Histogram
Measure High Ref	90% and 0 V (units)
Measure Low Ref	10% and 0 V (units)
Measure Mid Ref	50% and 0 V (units)
Measure Mid2 Ref	50% and 0 V (units)
Pulse glitch filter state	On (Accept glitch)
Pulse glitch trigger polarity	Positive
Pulse glitch width	2.0 ns
Pulse runt high threshold	1.2 V
Pulse runt low threshold	0.8 V
Pulse runt trigger polarity	Positive
Pulse runt width	2.0 ns
Pulse runt triggers when ...	Occurs
Pulse slew rate Delta Time	2.0 ns
Pulse slew rate polarity	Positive

Table D-1: Factory Initialization Defaults (Cont.)

Control	Changed by Factory Init to
Pulse slew rate thresholds Upper Lower	Trig if faster than 1.80 V 800 mV
Pulse slew rate triggers when ...	Trig if faster than
Pulse slew rate setting	
Pulse trigger class	Glitch
Pulse trigger level	0.0 V
Pulse trigger source (Glitch, runt, width, and slew rate)	Channel 1 (Ch 1)
Pulse width lower limit	2.0 ns
Pulse width trigger polarity	Positive
Pulse width trigger when ...	Within limits
Pulse width upper limit	2.0 ns
Repetitive signal (TDS 700A models only)	On
RS-232 parameters	No change
Saved setups	No change
Saved waveforms	No change
Stop after	R/S button
Vertical bandwidth (all channels)	Full
Vertical coupling (all channels)	DC
Vertical impedance (termination) (all channels)	1 M Ω
Vertical offset (all channels)	0 V
Vertical position (all channels)	0 divs.
Vertical volts/division (all channels)	100 mV/division
Zoom horizontal (all channels)	1.0X (TDS 684A); 2.0X (TDS 700A models)
Zoom horizontal lock	All
Zoom horizontal position (all channels)	50% = 0.5 (the middle of the display)
Zoom mode	Off
DZ (Dual Zoom) Offset (TDS 700A models only)	Minimum Available
Dual Window Zoom, Selected Graticule (TDS 700A models only)	Upper
Zoom vertical (all channels)	1.0X (TDS 684A); 2.0X (TDS 700A models)
Zoom vertical position (all channels)	0 divisions

Appendix E: Probe Selection

The TDS Oscilloscope can use a variety of Tektronix probes for taking different kinds of measurements. To help you decide what type of probe you need, this section introduces the five major types of probes: passive, active, current, optical, and time-to-voltage probes. See *Appendix A: Options and Accessories* for a list of the optional probes available; see your Tektronix Products Catalog for more information about a given probe.

Tektronix ships the P6139A passive probe with the TDS 744A Oscilloscope as a standard accessory. The TDS 684A and TDS 784A Oscilloscopes ship without standard probes but Tektronix recommends you order the P6245 active probe to take advantage of the 1 GHz bandwidth of these two oscilloscopes.

NOTE. *The TDS 744A comes with four P6139A passive probes. The TDS 684A and TDS 784A Oscilloscopes come without probes, but for general purpose measurements and to take advantage of the wide bandwidth of these two oscilloscopes, the P6245 Active Probe is recommended. This manual lists the P6245 optional-accessory probe in Appendix A: Options and Accessories.*

Passive Voltage Probes

Passive voltage probes measure voltage. They employ passive circuit components such as resistors, capacitors, and inductors. There are three common classes of passive voltage probes:

- General purpose (high input resistance)
- Low impedance (Z_0)
- High voltage

General Purpose (High Input Resistance) Probes

High input resistance probes are considered “typical” oscilloscope probes. The high input resistance of passive probes (typically 10 M Ω) provides negligible DC loading and makes them a good choice for accurate DC amplitude measurements.

However, their 8 pF to 12 pF (over 60 pF for 1X) capacitive loading can distort timing and phase measurements. Use high input resistance passive probes for measurements involving:

- Device characterization (above 15 V, thermal drift applications)

- Maximum amplitude sensitivity using 1X high impedance
- Large voltage range (between 15 and 500 V)
- Qualitative or go/no-go measurements

Low Impedance (Z_O) Probes

Low impedance probes measure frequency more accurately than general purpose probes, but they make less accurate amplitude measurements. They offer a higher bandwidth to cost ratio.

These probes must be terminated in a $50\ \Omega$ scope input. Input capacitance is much lower than high Z passive probes, typically 1 pF, but input resistance is also lower (500 to 5000 Ω typically). Although that DC loading degrades amplitude accuracy, the lower input capacitance reduces high frequency loading to the circuit under test. That makes Z_O probes ideal for timing and phase measurements when amplitude accuracy is not a major concern.

Z_O probes are useful for measurements up to 40 V.

High Voltage Probes

High voltage probes have attenuation factors in the 100X to 1000X range. The considerations that apply to other passive probes apply to high voltage probes with a few exceptions. Since the voltage range on high voltage probes varies from 1 kV to 20 kV (DC + peak AC), the probe head design is mechanically much larger than for a passive probe. High voltage probes have the added advantage of lower input capacitance (typically 2-3 pF).

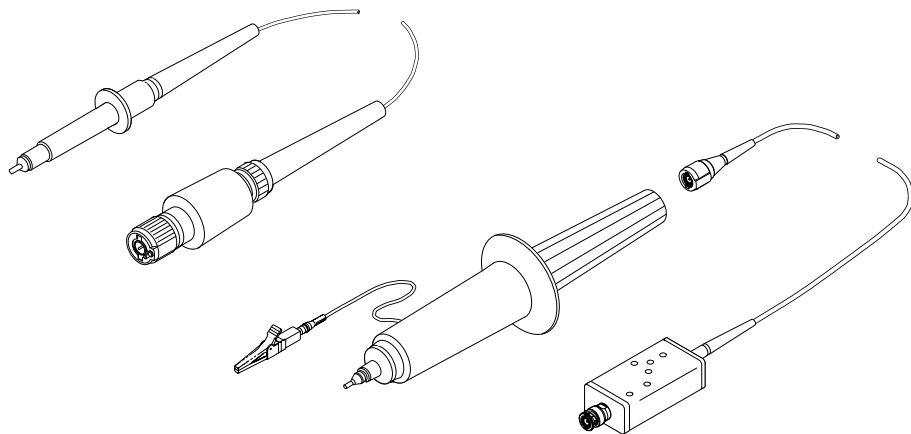

Figure E-1: Typical High Voltage Probes

Active Voltage Probes

Active voltage probes, sometimes called “FET” probes, use active circuit elements such as transistors. There are three classes of active probes:

- *High speed active*
- *Differential active*
- *Fixtured active*

Active voltage measuring probes use active circuit elements in the probe design to process signals from the circuit under test. All active probes require a source of power for their operation. Power is obtained either from an external power supply or from the oscilloscope itself.

Active voltage measuring probes use active circuit elements in the probe design to process signals from the circuit under test. All active probes require a source of power for their operation. Power is obtained either from an external power supply or from the oscilloscope itself.

NOTE. *When you connect an active probe to the oscilloscope (such as the P6245), the input impedance of the oscilloscope automatically becomes 50 Ω . If you then connect a passive probe, you need to set the input impedance back to 1 M Ω . The procedure To Change Vertical Scale and Position on page 3–10 explains how to change the input impedance. Also, please read Input Impedance Considerations on page 3–5 for more information.*

High Speed Active Probes

Active probes offer low input capacitance (1 to 2 pF typical) while maintaining the higher input resistance of passive probes (10 k Ω to 10 M Ω). Like Z_O probes, active probes are useful for making accurate timing and phase measurements. However, they do not degrade the amplitude accuracy. Active probes typically have a dynamic range of ± 8 to ± 15 V.

Differential Probes

Differential probes determine the voltage drop between two points in a circuit under test. Differential probes let you simultaneously measure two points and to display the difference between the two voltages.

Active differential probes are stand-alone products designed to be used with 50 Ω inputs. The same characteristics that apply to active probes apply to active differential probes.

Fixtured Active Probes

In some small-geometry or dense circuitry applications, such as surface mounted devices (SMD), a hand-held probe is too big to be practical. You can instead use fixtured (or probe card mounted) active probes (or buffered amplifiers) to

precisely connect your instrument to your device-under-test. These probes have the same electrical characteristics as high speed, active probes but use a smaller mechanical design.

Current Probes

Current probes enable you to directly observe and measure current waveforms, which can be very different from voltage signals. Tektronix current probes are unique in that they can measure from DC to 1 GHz.

Two types of current probes are available: one that measures AC current only and AC/DC probes that utilize the Hall effect to accurately measure the AC and DC components of a signal. AC-only current probes use a transformer to convert AC current flux into a voltage signal to the oscilloscope and have a frequency response from a few hundred Hertz up to 1 GHz. AC/DC current probes include Hall effect semiconductor devices and provide frequency response from DC to 50 MHz.

Use a current probe by clipping its jaws around the wire carrying the current that you want to measure. (Unlike an ammeter which you must connect in series with the circuit.) Because current probes are non-invasive, with loading typically in the milliohm to low Ω range, they are especially useful where low loading of the circuit is important. Current probes can also make differential measurements by measuring the results of two opposing currents in two conductors in the jaws of the probe.

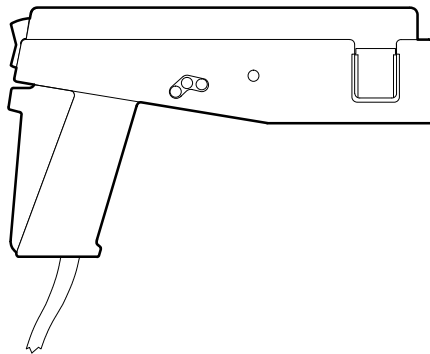

Figure E-2: A6303 Current Probe Used in the AM 503S Opt. 03

Optical Probes

Optical probes let you blend the functions of an optical power meter with the high-speed analog waveform analysis capability of an oscilloscope. You have the capability of acquiring, displaying, and analyzing optical and electrical signals simultaneously.

Applications include measuring the transient optical properties of lasers, LEDs, electro-optic modulators, and flashlamps. You can also use these probes in the development, manufacturing, and maintenance of fiber optic control networks, local area networks (LANs), fiber-based systems based on the FDDI and SONET standard, optical disk devices, and high-speed fiber optic communications systems.

NOTE. *When you connect any probe with a TEKPROBE (level 2) interface to the oscilloscope, the input impedance of the oscilloscope automatically becomes 50 Ω . If you then connect a high input impedance passive probe you need to set the input impedance back to 1 M Ω . The procedure To Change Vertical Parameters, on page 3–12, explains how to change the input impedance.*

Time-to-Voltage Converter

The instantaneous time-interval to voltage converter (TVC) continuously converts consecutive timing measurements to a time-interval versus time waveform.

Timing variations typically appear as left-to-right motion, or jitter, on an oscilloscope. Time base or trigger holdoff adjustments may improve display stability, but they do not show timing dynamics. The TVC untangles the often confusing waveforms and delivers a coherent real-time view.

The TVC adds three measurement functions to the voltage versus time capability of your oscilloscope: time delay versus time, pulse-width versus time, and period versus time.

Glossary



AC coupling

A type of signal transmission that blocks the DC component of a signal but uses the dynamic (AC) component. Useful for observing an AC signal that is normally riding on a DC signal.

Accuracy

The closeness of the indicated value to the true value.

Acquisition

The process of sampling signals from input channels, digitizing the samples into data points, and assembling the data points into a waveform record. The waveform record is stored in memory. The trigger marks time zero in that process.

Acquisition interval

The time duration of the waveform record divided by the record length. The oscilloscope displays one data point for every acquisition interval.

Active cursor

The cursor that moves when you turn the general purpose knob. It is represented in the display by a solid line. The @ readout on the display shows the absolute value of the active cursor.

Aliasing

A false representation of a signal due to insufficient sampling of high frequencies or fast transitions. A condition that occurs when an oscilloscope digitizes at an effective sampling rate that is too slow to reproduce the input signal. The waveform displayed on the oscilloscope may have a lower frequency than the actual input signal.



Amplitude

The High waveform value less the Low waveform value.



AND

A logic (Boolean) function in which the output is true when and only when all the inputs are true. On the oscilloscope, that is a trigger logic pattern and state function.



Area

Measurement of the waveform area taken over the entire waveform or the gated region. Expressed in volt-seconds. Area above ground is positive; area below ground is negative.

Attenuation

The degree the amplitude of a signal is reduced when it passes through an attenuating device such as a probe or attenuator. That is, the ratio of the input measure to the output measure. For example, a 10X probe will attenuate, or reduce, the input voltage of a signal by a factor of 10.

Automatic trigger mode

A trigger mode that causes the oscilloscope to automatically acquire if triggerable events are not detected within a specified time period.

Autoset

A function of the oscilloscope that automatically produces a stable waveform of usable size. Autoset sets up front-panel controls based on the characteristics of the active waveform. A successful autoset will set the volts/div, time/div, and trigger level to produce a coherent and stable waveform display.

**Average acquisition mode**

In this mode, the oscilloscope acquires and displays a waveform that is the averaged result of several acquisitions. Averaging reduces the apparent noise. The oscilloscope acquires data as in the sample mode and then averages it according to a specified number of averages.

**Bandwidth**

The highest frequency signal the oscilloscope can acquire with no more than 3 dB ($\times .707$) attenuation of the original (reference) signal.

**Burst width**

A timing measurement of the duration of a burst.

Channel

One type of input used for signal acquisition. The oscilloscope has four channels.

Channel Reference Indicator

The indicator on the left side of the display that points to the position around which the waveform contracts or expands when vertical scale is changed. This position is ground when offset is set to 0 V; otherwise, it is ground plus offset.

Coupling

The association of two or more circuits or systems in such a way that power or information can be transferred from one to the other. You can couple the input signal to the trigger and vertical systems several different ways.

Cursors

Paired markers that you can use to make measurements between two waveform locations. The oscilloscope displays the values (expressed in volts or time) of the position of the active cursor and the distance between the two cursors.

**Cycle area**

A measurement of waveform area taken over one cycle. Expressed in volt-seconds. Area above ground is positive; area below ground is negative.

**Cycle mean**

An amplitude (voltage) measurement of the arithmetic mean over one cycle.

**Cycle RMS**

The true Root Mean Square voltage over one cycle.

DC

DC coupling

A mode that passes both AC and DC signal components to the circuit. Available for both the trigger system and the vertical system.

**Delay measurement**

A measurement of the time between the middle reference crossings of two different waveforms.

Delay time

The time between the trigger event and the acquisition of data.

Digitizing

The process of converting a continuous analog signal such as a waveform to a set of discrete numbers representing the amplitude of the signal at specific points in time. Digitizing is composed of two steps: sampling and quantizing.

Display system

The part of the oscilloscope that shows waveforms, measurements, menu items, status, and other parameters.

Edge Trigger

Triggering occurs when the oscilloscope detects the source passing through a specified voltage level in a specified direction (the trigger slope).

**Envelope acquisition mode**

A mode in which the oscilloscope acquires and displays a waveform that shows the variation extremes of several acquisitions.

Equivalent-time sampling (ET)

TDS 700A Models Only: A sampling mode in which the oscilloscope acquires signals over many repetitions of the event. The TDS 744A and TDS 784A Oscilloscopes use a type of equivalent time sampling called *random equivalent time sampling*. It utilizes an internal clock that runs asynchronously with respect to the input signal and the signal trigger. The oscilloscope takes samples continuously, independent of the trigger position, and displays them based on the time difference between the sample and the trigger. Although the samples are taken sequentially in time, they are random with respect to the trigger.

**Fall time**

A measurement of the time it takes for the trailing edge of a pulse to fall from a HighRef value (typically 90%) to a LowRef value (typically 10%) of its amplitude.

**Frequency**

A timing measurement that is the reciprocal of the period. Measured in Hertz (Hz) where 1 Hz = 1 cycle per second.

Gated Measurements

A feature that lets you limit automated measurements to a specified portion of the waveform. You define the area of interest using the vertical cursors.

**General purpose knob**

The large front-panel knob with an indentation. You can use it to change the value of the assigned parameter.

**Glitch positive trigger**

Triggering occurs if the oscilloscope detects positive spike widths less than the specified glitch time.

**Glitch negative trigger**

Triggering occurs if the oscilloscope detects negative spike widths less than the specified glitch time.

**Glitch either trigger**

Triggering occurs if the oscilloscope detects either positive or negative spike widths less than the specified glitch time.

**GPIB (General Purpose Interface Bus)**

An interconnection bus and protocol that allows you to connect multiple instruments in a network under the control of a controller. Also known as IEEE 488 bus. It transfers data with eight parallel data lines, five control lines, and three handshake lines.

**Graticule**

A grid on the display screen that creates the horizontal and vertical axes. You can use it to visually measure waveform parameters.

**Ground (GND) coupling**

Coupling option that disconnects the input signal from the vertical system.

**Hardcopy**

An electronic copy of the display in a format useable by a printer or plotter.

**Hi Res acquisition mode**

TDS 700A Models Only: An acquisition mode in which the oscilloscope averages all samples taken during an acquisition interval to create a record point. That average results in a higher-resolution, lower-bandwidth waveform. That mode only works with real-time, non-interpolated sampling.



High

The value used as 100% in automated measurements (whenever high ref, mid ref, and low ref values are needed as in fall time and rise time measurements). May be calculated using either the min/max or the histogram method. With the min/max method (most useful for general waveforms), it is the maximum value found. With the histogram method (most useful for pulses), it refers to the most common value found above the mid point. See *Appendix B: Algorithms* for details.

Holdoff, trigger

A specified amount of time after a trigger signal that elapses before the trigger circuit will accept another trigger signal. Trigger holdoff helps ensure a stable display.



Horizontal bar cursors

The two horizontal bars that you position to measure the voltage parameters of a waveform. The oscilloscope displays the value of the active (moveable) cursor with respect to ground and the voltage value between the bars.

Interpolation

The way the oscilloscope calculates values for record points when the oscilloscope cannot acquire all the points for a complete record with a single trigger event. That condition occurs when the oscilloscope is limited to real time sampling and the time base is set to a value that exceeds the effective sample rate of the oscilloscope. The oscilloscope has two interpolation options: *linear* or *sin(x)/x interpolation*.

Linear interpolation calculates record points in a straight-line fit between the actual values acquired. Sin(x)/x computes record points in a curve fit between the actual values acquired. It assumes all the interpolated points fall in their appropriate point in time on that curve.

Intensity

Display brightness.

InstaVu acquisition mode

A mode that increases the waveform capture rate to up to 400,000 waveforms per second. This very fast capture rate greatly increases the probability that runts, glitches, and other short term changes will accumulate in waveform memory. The oscilloscope then displays the waveform at the normal display rate using variable or infinite persistence.

Interleaving

TDS 700A Models Only: A method by which the TDS 744A and TDS 784A Oscilloscopes attain higher digitizing speeds. The oscilloscope applies the digitizing resources of unused channels (that is, channels that are turned off) to sample those that are in use (turned on). Table 3–2 on page 3–19 lists acquisition rates vs. number of channels that are on.

Knob

A rotary control.

**Logic state trigger**

The oscilloscope checks for defined combinatorial logic conditions on channels 1, 2, and 3 on a transition of channel 4 that meets the set slope and threshold conditions. If the conditions of channels 1, 2, and 3 are met then the oscilloscope triggers.

**Logic pattern trigger**

The oscilloscope triggers depending on the combinatorial logic condition of channels 1, 2, 3, and 4. Allowable conditions are AND, OR, NAND, and NOR.

**Low**

The value used as 0% in automated measurements (whenever high ref, mid ref, and low ref values are needed as in fall time and rise time measurements). May be calculated using either the min/max or the histogram method. With the min/max method (most useful for general waveforms), it is the minimum value found. With the histogram method (most useful for pulses), it refers to the most common value found below the mid point. See *Appendix B: Algorithms* for details.

Main menu

A group of related controls for a major oscilloscope function that the oscilloscope displays across the bottom of the screen.

Main menu buttons

Bezel buttons under the main menu display. They allow you to select items in the main menu.

**Maximum**

Amplitude (voltage) measurement of the maximum amplitude. Typically the most positive peak voltage.

**Mean**

Amplitude (voltage) measurement of the arithmetic mean over the entire waveform.

**Minimum**

Amplitude (voltage) measurement of the minimum amplitude. Typically the most negative peak voltage.

**NAND**

A logic (Boolean) function in which the output of the AND function is complemented (true becomes false, and false becomes true). On the oscilloscope, that is a trigger logic pattern and state function.

**Negative duty cycle**

A timing measurement representing the ratio of the negative pulse width to the signal period, expressed as a percentage.

**Negative overshoot measurement**

Amplitude (voltage) measurement.

$$\text{NegativeOvershoot} = \frac{\text{Low} - \text{Min}}{\text{Amplitude}} \times 100\%$$

**Negative width**

A timing measurement of the distance (time) between two amplitude points — falling-edge *MidRef* (default 50%) and rising-edge *MidRef* (default 50%) — on a negative pulse.

Normal trigger mode

A mode on which the oscilloscope does not acquire a waveform record unless a valid trigger event occurs. It waits for a valid trigger event before acquiring waveform data.

**NOR**

A logic (Boolean) function in which the output of the OR function is complemented (true becomes false, and false becomes true). On the oscilloscope, that is a trigger logic pattern and state function.

**OR**

A logic (Boolean) function in which the output is true if any of the inputs are true. Otherwise the output is false. On the oscilloscope, that is a trigger logic pattern and state function.

Oscilloscope

An instrument for making a graph of two factors. These are typically voltage versus time.

**Peak Detect acquisition mode**

TDS 700A Models Only: A mode in which the oscilloscope saves the minimum and maximum samples over two adjacent acquisition intervals. For many glitch-free signals, that mode is indistinguishable from the sample mode. (Peak detect mode works with real-time, non-interpolation sampling only.)

**Peak-to-Peak**

Amplitude (voltage) measurement of the absolute difference between the maximum and minimum amplitude.

**Period**

A timing measurement of the time covered by one complete signal cycle. It is the reciprocal of frequency and is measured in seconds.

**Phase**

A timing measurement between two waveforms of the amount one leads or lags the other in time. Phase is expressed in degrees, where 360° comprise one complete cycle of one of the waveforms. Waveforms measured should be of the same frequency or one waveform should be a harmonic of the other.

Pixel

A visible point on the display. The oscilloscope display is 640 pixels wide by 480 pixels high.

Pop-up Menu

A sub-menu of a main menu. Pop-up menus temporarily occupy part of the waveform display area and are used to present additional choices associated with the main menu selection. You can cycle through the options in a pop-up menu by repeatedly pressing the main menu button underneath the pop-up.

**Positive duty cycle**

A timing measurement of the ratio of the positive pulse width to the signal period, expressed as a percentage.

**Positive overshoot**

Amplitude (voltage) measurement.

$$\text{PositiveOvershoot} = \frac{\text{Max} - \text{High}}{\text{Amplitude}} \times 100\%$$

**Positive width**

A timing measurement of the distance (time) between two amplitude points — rising-edge *MidRef* (default 50%) and falling-edge *MidRef* (default 50%) — on a positive pulse.

Posttrigger

The specified portion of the waveform record that contains data acquired after the trigger event.

Pretrigger

The specified portion of the waveform record that contains data acquired before the trigger event.

Probe

An oscilloscope input device.

Quantizing

The process of converting an analog input that has been sampled, such as a voltage, to a digital value.

Probe compensation

Adjustment that improves low-frequency response of a probe.

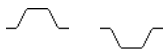
**Pulse trigger**

A trigger mode in which triggering occurs if the oscilloscope finds a pulse, of the specified polarity, with a width between, or optionally outside, the user-specified lower and upper time limits.

Real-time sampling

A sampling mode where the oscilloscope samples fast enough to completely

fill a waveform record from a single trigger event. Use real-time sampling to capture single-shot or transient events.

Record length

The specified number of samples in a waveform.

Reference memory

Memory in an oscilloscope used to store waveforms or settings. You can use that waveform data later for processing. The oscilloscope saves the data even when the oscilloscope is turned off or unplugged.

**Rise time**

The time it takes for a leading edge of a pulse to rise from a *LowRef* value (typically 10%) to a *HighRef* value (typically 90%) of its amplitude.

**RMS**

Amplitude (voltage) measurement of the true Root Mean Square voltage.

Runt trigger

A mode in which the oscilloscope triggers on a runt. A runt is a pulse that crosses one threshold but fails to cross a second threshold before recrossing the first. The crossings detected can be positive, negative, or either.

**Sample acquisition mode**

The oscilloscope creates a record point by saving the first sample during each acquisition interval. That is the default mode of the acquisition.

Sample interval

The time interval between successive samples in a time base. For real-time digitizers, the sample interval is the reciprocal of the sample rate. For equivalent-time digitizers, the time interval between successive samples represents equivalent time, not real time.

Sampling

The process of capturing an analog input, such as a voltage, at a discrete point in time and holding it constant so that it can be quantized. Two general methods of sampling are: *real-time sampling* and *equivalent-time sampling*.

Setup/Hold trigger

A mode in which the oscilloscope triggers when a data source changes state within the setup or hold time relative to a clock source. Positive setup times precede the clock edge; positive hold times follow the clock edge. The clock edge may be the rising or falling edge.

Select button

A button that changes which of the two cursors is active.

Selected waveform

The waveform on which all measurements are performed, and which is affected by vertical position and scale adjustments. The light over one of the channel selector buttons indicates the current selected waveform.

Side menu

Menu that appears to the right of the display. These selections expand on main menu selections.

Side menu buttons

Bezel buttons to the right of the side menu display. They allow you to select items in the side menu.

Slew Rate trigger

A mode in which the oscilloscope triggers based on how fast a pulse edge traverses (slews) between an upper and lower threshold. The edge of the pulse may be positive, negative, or either. The oscilloscope can trigger on slew rates faster or slower than a user-specified rate.

Slope

The direction at a point on a waveform. You can calculate the direction by computing the sign of the ratio of change in the vertical quantity (Y) to the change in the horizontal quantity. The two values are rising and falling.

Tek Secure

This feature erases all waveform and setup memory locations (setup memories are replaced with the factory setup). Then it checks each location to verify erasure. This feature finds use where this oscilloscope is used to gather security sensitive data, such as is done for research or development projects.

Time base

The set of parameters that let you define the time and horizontal axis attributes of a waveform record. The time base determines when and how long to acquire record points.

Trigger

An event that marks time zero in the waveform record. It results in acquisition and display of the waveform.



Trigger level

The vertical level the trigger signal must cross to generate a trigger (on edge trigger mode).



Vertical bar cursors

The two vertical bars you position to measure the time parameter of a waveform record. The oscilloscope displays the value of the active (moveable) cursor with respect to the trigger and the time value between the bars.

Waveform

The shape or form (visible representation) of a signal.

Waveform interval

The time interval between record points as displayed.

**XY format**

A display format that compares the voltage level of two waveform records point by point. It is useful for studying phase relationships between two waveforms.

**YT format**

The conventional oscilloscope display format. It shows the voltage of a waveform record (on the vertical axis) as it varies over time (on the horizontal axis).

Index

Numbers

- 1/seconds (Hz), Cursor menu, 3–101
- 20 MHz, Vertical menu, 3–12
- 250 MHz, Vertical menu, 3–12

A

- AC coupling, Glossary–1
- AC line voltage, trigger input, 3–50
- AC, Main Trigger menu, 3–58
- Accept Glitch, Main Trigger menu, 3–73
- Accessories, A–1–A–6
 - Optional, A–4–A–6
 - Probes, A–4
 - Software, A–5
 - Standard, A–3, A–5
- Accuracy, Glossary–1
- Acquire menu, 3–23
 - Average, 3–23
 - Average mode, 3–138
 - Compare Ch1 to, 3–140
 - Compare Ch2 to, 3–140
 - Compare Ch3 to, 3–140
 - Compare Ch4 to, 3–140
 - Compare Math1 to, 3–140
 - Compare Math2 to, 3–140
 - Compare Math3 to, 3–140
 - Create Limit Test Template, 3–138
 - Envelope, 3–23
 - H Limit, 3–139
 - Hardcopy if Condition Met, 3–140
 - Hi Res, 3–23
 - Limit Test, 3–141
 - Limit Test Condition Met, 3–141
 - Limit Test Setup, 3–140, 3–141
 - Limit Test Sources, 3–140
 - Limit Testing, 3–138
 - OFF (Real Time Only), 3–24
 - OK Store Template, 3–139
 - ON (Enable ET), 3–24
 - Peak Detect, 3–23
 - Repetitive Signal, 3–24
 - Ring Bell if Condition Met, 3–140
 - RUN/STOP, 3–26
 - Sample, 3–23
 - Single Acquisition Sequence, 3–26
 - Stop After, 3–25, 3–141
 - Stop After Limit Test Condition Met, 3–140
 - Template Source, 3–138
 - V Limit, 3–139
- ACQUIRE MENU button, 3–23, 3–138
- Acquiring and Displaying Waveforms, 3–3
- Acquisition, 3–16–3–48, Glossary–1
 - Interval, Glossary–1
 - Mode, envelope, 3–20
 - Modes
 - Average, 3–20, 3–48
 - Envelope, 3–48
 - Hi Res, 3–22, 3–48
 - Peak detect, 3–22
 - Sample, 3–20
 - Readout, 3–23
- Acquisition mode, Choosing an, 3–16
- Acquisition modes
 - How to select, 3–23
 - Incompatible with InstaVu, 3–46
- Active cursor, Glossary–1
- Active voltage probes, E–3–E–6
- active, Saved waveform status, 3–114
- Advanced applications, Features for, 3–137
- Algorithms, B–1–B–14
- Aliasing, 3–26, 3–155, Glossary–1
- Amplitude, 3–88, Glossary–1
- Amplitude Units, Cursor menu, 3–101
- AND, Glossary–1
- AND, Main Trigger menu, 3–66, 3–68
- Applications
 - derivative math waveforms, 3–162
 - FFT math waveforms, 3–144
 - integral math waveforms, 3–165
- Area, 3–88, Glossary–1
- Attenuation, Glossary–2
- Auto, Main Trigger menu, 3–59
- Automated Measurements, Snapshot of, 2–23
- Automated measurements, 2–19, 3–87
 - of derivative math waveforms, 3–163
 - (procedure), 3–163
 - of FFT math waveforms, 3–150
 - of integral math waveforms, 3–169
- Automatic trigger mode, 3–51, Glossary–2
- Autosave, Save/Recall Waveform menu, 3–116
- Autoset, 2–14, 3–5–3–48, Glossary–2
 - Default settings, 3–6–3–48
 - How to execute, 3–6–3–48
- AUTOSET button, 2–14
- AUX TRIGGER INPUT, BNC, 2–5
- Auxiliary trigger, 3–50

Average, Incompatible with InstaVu, 3–46
 Average acquisition mode, 3–20, 3–48, Glossary–2
Average mode, Acquire menu, 3–138
Average, Acquire menu, 3–23
Average, More menu, 3–144

B

Bandwidth, Glossary–2
 Selecting, 3–12
Bandwidth, Vertical menu, 3–12
Base, Cursor menu, 3–101
 Blackman-Harris window, 3–148
 BMP, 3–121
BMP Color, Hardcopy menu, 3–122
BMP Mono, Hardcopy menu, 3–122
 BNC
 AUX TRIGGER INPUT, 2–5
 DELAYED TRIGGER OUTPUT, 2–5
 MAIN TRIGGER OUTPUT, 2–5
 SIGNAL OUTPUT, 2–5
Bold, Color menu, 3–34
 Burst width, 3–88
 Button
 ACQUIRE MENU, 3–23, 3–138
 AUTOSET, 2–14
 CLEAR MENU, 2–3, 2–8, 2–12, 2–20, 2–21, 3–95
 CURSOR, 3–99
 DELAYED TRIG, 3–53, 3–83
 DISPLAY, 3–28, 3–33
 FORCE TRIG, 3–54
 HARDCOPY, 3–117, 3–122, 3–131
 HELP, 3–135
 HORIZONTAL MENU, 3–53, 3–83
 InstaVu, 3–43
 MEASURE, 3–90
 MORE, 3–8, 3–115, 3–142
 ON/STBY, 1–5, 2–3
 Save/Recall **SETUP**, 2–10, 3–7, 3–111, 3–117
 Save/Recall **WAVEFORM**, 3–114, 3–117
 SELECT, 3–100, Glossary–9
 SET LEVEL TO 50%, 3–54
 SINGLE TRIG, 3–26, 3–55
 STATUS, 3–133
 TRIGGER MENU, 3–57, 3–58, 3–64, 3–67, 3–68, 3–72, 3–74, 3–77
 UTILITY, 3–103, 3–122, 3–131
 VERTICAL MENU, 2–17
 WAVEFORM OFF, 2–18, 3–8, 3–32
 ZOOM, 3–37, 3–38
 Buttons
 CH1, CH2 ..., 3–8

Channel selection, 2–16, 3–8
 Main menu, 2–3
 Side menu, 2–3

C

Cables, 3–130
Cal Probe, Vertical menu, 3–104
 Calibration Certificate, Option 9C, A–3
 Cart, Oscilloscope, A–1
 Centronics, 2–5
 Port, 3–123, 3–128
CH1, CH2 ... buttons, 3–8
Ch1, Ch2 ..., Delayed Trigger menu, 3–85
Ch1, Ch2 ..., Main Trigger menu, 3–58, 3–65, 3–68, 3–69, 3–73, 3–74, 3–76, 3–77
Change Colors, Color menu, 3–34
 Channel, Glossary–2
 Readout, 2–6, 3–8, 3–38
 Reference Indicator, 2–6, 3–8
 Selection buttons, 2–16, 3–8
 Trigger input, 3–50–3–86
 Channel readout, 2–6
 Channel reference indicator, Glossary–2
 Channels, Selecting, 3–7–3–48
 Circuit loading, Glossary–2
Class Glitch, Main Trigger menu, 3–72
Class, Main Trigger menu, 3–76
 Pattern, 3–64
 Runt, 3–74
 Setup/Hold, 3–68
 Slew Rate, 3–77
 State, 3–67
 Classes, Pulse triggers, 3–71
CLEAR MENU button, 2–3, 2–8, 2–12, 2–20, 2–21, 3–95
Clear Spool, Hardcopy menu, 3–126
 Clipping
 derivative math waveforms, 3–164
 FFT math waveforms, 3–153
 how to avoid, 3–153, 3–164, 3–169
 integral math waveforms, 3–169
Clock Source, Main Trigger menu, 3–69
Collision Contrast, Color menu, 3–36
 Color, 3–33–3–48
 How to set, 3–33–3–48
Color Matches Contents, Color menu, 3–35, 3–36
 Color menu, 3–33
 Bold, 3–34
 Change Colors, 3–34
 Collision Contrast, 3–36
 Color, 3–34, 3–35, 3–36

- Color Matches Contents**, 3–35, 3–36
 - Hardcopy**, 3–34
 - Hue**, 3–34
 - Lightness**, 3–34
 - Map Math**, 3–35
 - Map Reference**, 3–35
 - Math**, 3–35
 - Monochrome**, 3–34
 - Normal**, 3–34
 - Options**, 3–36
 - Palette**, 3–33
 - Persistence Palette**, 3–34
 - Ref**, 3–36
 - Reset All Mappings To Factory**, 3–36
 - Reset All Palettes To Factory**, 3–36
 - Reset Current Palette To Factory**, 3–36
 - Reset to Factory Color**, 3–34
 - Restore Colors**, 3–36
 - Saturation**, 3–35
 - Spectral**, 3–34
 - Temperature**, 3–34
 - View Palette**, 3–34
 - Color**, Color menu, 3–34, 3–35, 3–36
 - Color**, Display menu, 3–33
 - Compare Ch1 to**, Acquire menu, 3–140
 - Compare Ch2 to**, Acquire menu, 3–140
 - Compare Ch3 to**, Acquire menu, 3–140
 - Compare Ch4 to**, Acquire menu, 3–140
 - Compare Math1 to**, Acquire menu, 3–140
 - Compare Math2 to**, Acquire menu, 3–140
 - Compare Math3 to**, Acquire menu, 3–140
 - Compensation, of passive probes, 3–3
 - Configure**, Utility menu, 3–122, 3–131
 - Confirm Delete**, File Utilities menu, 3–120
 - Connector
 - AUX TRIGGER INPUT**, 2–5
 - Centronics, 2–5
 - DELAYED TRIGGER OUTPUT**, 2–5
 - GPIB, 2–5, 3–130
 - MAIN TRIGGER OUTPUT**, 2–5
 - Power, 2–5
 - RS-232, 2–5
 - SIGNAL OUTPUT**, 2–5
 - VGA, 2–5
 - Contrast**, Display menu, 3–29
 - Conventions, xiv
 - Copy**, File Utilities menu, 3–119
 - Coupling, 2–17
 - Ground, Glossary–4
 - Selecting, 3–12–3–48
 - Trigger, 3–52–3–86
 - Coupling Waveforms, 3–3
 - Coupling**, Delayed Trigger menu, 3–85
 - Coupling**, Main Trigger menu, 3–58
 - Coupling**, Vertical menu, 3–12
 - Create Directory**, File Utilities menu, 3–119
 - Create Limit Test Template**, Acquire menu, 3–138
 - Create Measrmnt**, Measure Delay menu, 3–95
 - Cross Hair**, Display menu, 3–31
 - Current probes, E–4
 - Cursor
 - Horizontal bar, 3–97
 - Measurements, 3–97
 - modes, 3–98
 - Paired, 3–97
 - readout, 3–98
 - Setting adjustment response (speed), 3–101
 - Vertical bar, 3–97
 - CURSOR** button, 3–99
 - Cursor measurements, 3–87
 - Cursor menu, 3–99, 3–149, 3–167
 - 1/seconds (Hz)**, 3–101
 - Amplitude Units**, 3–101
 - Base**, 3–101
 - Function**, 3–99, 3–100
 - H Bars**, 3–99, 3–100
 - Independent**, 3–100
 - IRE (NTSC)**, 3–101
 - seconds**, 3–101
 - Time Units**, 3–101
 - Tracking**, 3–100
 - Video Line Number**, 3–101
 - Cursor readout
 - H-Bars, 3–149, 3–163, 3–167
 - Paired, 3–163
 - Paired cursors, 3–150, 3–168
 - V-Bars, 3–149, 3–163, 3–168
 - Cursors, 3–97, 3–101–3–110, Glossary–2
 - How to use, 3–99
 - with derivative waveforms, 3–163
 - with FFT waveforms, 3–149
 - with integral waveforms, 3–167
 - Cycle area, 3–88, Glossary–3
 - Cycle mean, 3–88, Glossary–3
 - Cycle RMS, 3–88, Glossary–3
- ## D
- Data Source**, Main Trigger menu, 3–68
 - Date/Time
 - On hardcopies, 3–123
 - To set, 3–124
 - DC coupling, Glossary–3
 - DC offset, 3–153
 - for DC correction of FFTs, 3–153

- with math waveforms, 3–153, 3–169
- DC**, Main Trigger menu, 3–58
- Define Inputs**, Main Trigger menu, 3–65, 3–67, 3–69
- Define Logic**, Main Trigger menu, 3–66, 3–68
- Delay by Events**, Delayed Trigger menu, 3–84
- Delay by Time**, Delayed Trigger menu, 3–84
- Delay by**, Delayed Trigger menu, 3–84
- Delay measurement, 3–94, Glossary–3
- Delay time, Glossary–3
- Delay To**, Measure Delay menu, 3–94
- Delayed Only**, Horizontal menu, 3–83
- Delayed Runs After Main, 3–53–3–86
- Delayed Runs After Main**, Horizontal menu, 3–16, 3–83
- Delayed Scale**, Horizontal menu, 3–15
- Delayed time base, Incompatible with InstaVu, 3–46
- DELAYED TRIG** button, 3–53, 3–83
- Delayed trigger, 3–53–3–86
 - How to set up, 3–83
- Delayed Trigger menu, 3–83–3–86
 - Ch1, Ch2 ...**, 3–85
 - Coupling**, 3–85
 - Delay by**, 3–84
 - Delay by Events**, 3–84
 - Delay by Time**, 3–84
 - Falling edge, 3–85
 - Level**, 3–85
 - Rising edge, 3–85
 - Set to 50%**, 3–85
 - Set to ECL**, 3–85
 - Set to TTL**, 3–85
 - Slope**, 3–85
 - Source**, 3–85
- DELAYED TRIGGER OUTPUT**, BNC, 2–5
- Delayed Triggerable, 3–53–3–86
- Delayed Triggerable**, Horizontal menu, 3–16, 3–83
- Delete Refs**, Save/Recall Waveform menu, 3–115
- Delete**, File Utilities menu, 3–118
- Delta Time**, Main Trigger menu, 3–78
- Derivative math waveform, 3–162
 - applications, 3–162
 - derivation of, 3–162
 - procedure for displaying, 3–162
 - procedure for measuring, 3–163
 - record length of, 3–162
- Desk Top Publishing, 3–121
 - Hardcopy, 3–111
- Deskjet, 3–121
- Deskjet**, Hardcopy menu, 3–122
- Differential active probes, E–3
- Differentiation
 - of a derivative, 3–162
 - waveform, 3–161
- Digitizing, Glossary–3
- Disk, How to save a hardcopy to, 3–126
- Disk drive, 3–117–3–132
- Display, 2–6
 - Hardcopy of, 3–120
 - Options, 3–27–3–48
 - Record View, 3–56
 - System, Glossary–3
- Display ‘T’ @ Trigger Point**, Display menu, 3–30
- DISPLAY** button, 3–28, 3–33
- Display menu, 3–28, 3–33
 - Color**, 3–33
 - Contrast**, 3–29
 - Cross Hair**, 3–31
 - Display**, 3–28
 - Display ‘T’ @ Trigger Point**, 3–30
 - Dots**, 3–28
 - Dots style**, 3–140
 - Filter**, 3–31
 - Frame**, 3–31
 - Full**, 3–31
 - Graticule**, 3–31–3–48
 - Grid**, 3–31
 - Infinite Persistence**, 3–28
 - Intensified Samples**, 3–28
 - Intensity**, 3–29–3–48
 - Linear interpolation**, 3–31
 - NTSC, 3–31
 - Overall**, 3–29
 - PAL, 3–31
 - Readout**, 3–29, 3–31
 - Settings**, 3–28, 3–33
 - Sin(x)/x interpolation**, 3–31
 - Style**, 3–28
 - Text/Grat**, 3–29
 - Trigger Bar**, 3–30
 - Variable Persistence**, 3–28
 - Vectors**, 3–28
 - Waveform**, 3–29
 - XY, 3–31
 - YT, 3–31
- Display**, Display menu, 3–28
- Display**, Status menu, 3–133
- Dots, 3–28
- Dots style**, Display menu, 3–140
- Dots**, Display menu, 3–28
- DPU411–II**, Hardcopy menu, 3–122
- DPU412**, Hardcopy menu, 3–122
- Dual Wfm Math**, More menu, 3–143
- Dual Window Zoom, 3–40
- Dual Zoom**, Zoom menu, 3–41
- Dual Zoom Offset**, Zoom menu, 3–41
- Duty cycle, 2–20, Glossary–6, Glossary–8

E

Edge trigger, 3–50, 3–57, Glossary–3
 How to set up, 3–58–3–86
 Readout, 3–57

Edge, Main Trigger menu, 3–57, 3–58

Edges, Measure Delay menu, 3–95

Either, Main Trigger menu, 3–73, 3–74, 3–77

empty, Saved waveform status, 3–114

Encapsulated Postscript, 3–121

Enter Char, Labelling menu, 3–118, 3–119

Envelope, Incompatible with InstaVu, 3–46

Envelope acquisition mode, 3–20, 3–48, Glossary–3

Envelope, Acquire menu, 3–23

EPS Color Img, Hardcopy menu, 3–122

EPS Color Plt, Hardcopy menu, 3–122

EPS Mono Img, Hardcopy menu, 3–122

EPS Mono Plt, Hardcopy menu, 3–122

Epson, 3–121

Epson, Hardcopy menu, 3–122

Equivalent time sampling, 3–18, 3–48

Equivalent-time sampling, random, Glossary–3

F

Factory initialization settings, D–1–D–6

Factory Setup, How to execute, 3–7–3–48

factory, Saved setup status, 3–111

Fall time, 3–88, Glossary–4

Falling edge, Delayed Trigger menu, 3–85

Falling edge, Main Trigger menu, 3–60, 3–68, 3–69

Fast Fourier Transforms, description, 3–144

Fast Fourier Transforms (FFTs), applications, 3–144

FastFrame, Incompatible with InstaVu, 3–45

FastFrame interactions, 3–48, 3–99

FastFrame Setup, Horizontal menu, 3–47

FastFrame, Horizontal menu, 3–47

FFT frequency domain record, 3–150
 defined, 3–151–3–152
 length of, 3–152

FFT math waveform, 3–145
 acquisition mode, 3–154
 aliasing, 3–155
 automated measurements of, 3–150
 DC correction, 3–153
 derivation of, 3–145
 displaying phase, 3–147
 frequency range, 3–152
 frequency resolution, 3–152
 interpolation mode, 3–154
 magnifying, 3–154
 phase display, setup considerations, 3–156

phase suppression, 3–148, 3–157
 procedure for displaying, 3–146
 procedure for measuring, 3–149
 record length, 3–152
 reducing noise, 3–154
 undersampling, 3–155
 zero phase reference, 3–156

FFT time domain record, defined, 3–151

File System, 3–117–3–132

File Utilities menu, 3–117
Confirm Delete, 3–120
Copy, 3–119
Create Directory, 3–119
Delete, 3–118
File Utilities, 3–117
Format, 3–120
Overwrite Lock, 3–120
Print, 3–119
Rename, 3–118

File Utilities, File Utilities menu, 3–117

File Utilities, Save/Recall Setup menu, 3–113

File Utilities, Save/Recall Waveform menu, 3–117

Filter, Display menu, 3–31

Fine Scale, Vertical menu, 3–12

Firmware version, 3–133

Fit to screen, Horizontal menu, 3–15

Fixtured active probes, E–3

FORCE TRIG button, 3–54

Format, File Utilities menu, 3–120

Format, Hardcopy menu, 3–122

Frame Count, Horizontal menu, 3–47

Frame Length, Horizontal menu, 3–47

Frame, Display menu, 3–31

Frame, Horizontal menu, 3–47

Frequency, 2–19, 3–88, Glossary–4

Front Cover removal, 1–5

Front panel, 2–4

Full, Display menu, 3–31

Full, Vertical menu, 3–12

Function, Cursor menu, 3–99, 3–100

Fuse, 1–4, 2–5

G

Gated Measurements, 3–91, Glossary–4

Gating, Measure menu, 3–91

General purpose (high input resistance) probes, E–1

General purpose knob, 2–7, 2–21, Glossary–4

Glitch trigger, 3–71, Glossary–4
 How to set up, 3–72–3–86

Glitch, Main Trigger menu, 3–73

Goes FALSE, Main Trigger menu, 3–66, 3–68

Goes TRUE, Main Trigger menu, 3-66, 3-68

GPIB, 2-5, 3-129-3-132, Glossary-4

Connecting to, 3-130

Interconnect cabling, 3-130

Interface requirements, 3-129

Procedures for using, 3-130

Protocols, 3-129

Selecting and configuring the port, 3-131

Typical configuration, 3-129

GPIB, Hardcopy menu, 3-123

GPIB, Utility menu, 3-131

Graticule, 3-31, Glossary-4

Measurements, 3-87

Graticule, Display menu, 3-31-3-48

Grid, Display menu, 3-31

Ground coupling, Glossary-4

GROUP 1, GROUP 2 ... buttons, 3-38

H

H Bars, Cursor menu, 3-99, 3-100

H Limit, Acquire menu, 3-139

Hamming window, 3-148

Hanning window, 3-148

Hardcopy, 3-120-3-132, Glossary-4

How to print (controller), 3-127

How to print (no controller), 3-125

How to save to disk, 3-126

How to set up for, 3-122

Printing a hardcopy, 3-120

Spool, 3-125, 3-126

Hardcopy (Talk Only), Utility menu, 3-122

HARDCOPY button, 3-117, 3-122, 3-131

Hardcopy if Condition Met, Acquire menu, 3-140

Hardcopy menu

BMP Color, 3-122

BMP Mono, 3-122

Clear Spool, 3-122, 3-126

Deskjet, 3-122

DPU411-II, 3-122

DPU412, 3-122

EPS Color Img, 3-122

EPS Color Plt, 3-122

EPS Mono Img, 3-122

EPS Mono Plt, 3-122

Epson, 3-122

Format, 3-122

GPIB, 3-123

HPGL, 3-122

Interleaf, 3-122

Landscape, 3-122

Laserjet, 3-122

Layout, 3-122

OK Confirm Clear Spool, 3-126

Palette, 3-123

PCX, 3-122

PCX Color, 3-122

Port, 3-123

Portrait, 3-122

RLE Color, 3-122

Thinkjet, 3-122

TIFF, 3-122

Hardcopy, Color menu, 3-34

Hardcopy, Utility menu, 3-131

Help, Accessing, 3-133

HELP button, 3-135

Help system, 3-133

HF Rej, Main Trigger menu, 3-58

Hi Res, Incompatible with InstaVu, 3-46

Hi Res acquisition mode, 3-22, Glossary-4

Hi Res, Acquire menu, 3-23

High, 3-88, Glossary-5

High Ref, Measure menu, 3-94

High speed active probes, E-3

High voltage probes, E-2

High-Low Setup, Measure menu, 3-92

Hi Res acquisition mode, 3-48

Histogram, Measure menu, 3-92

Holdoff, trigger, 3-51, Glossary-5

Horiz Pos, Horizontal menu, 3-16

Horiz Scale, Horizontal menu, 3-15

Horizontal

Bar cursors, 3-97, Glossary-5

Control, 3-13-3-48

Menu, 3-53

Position, 3-13

Readouts, 3-13

Scale, 3-13

SCALE knob, 2-13

System, 2-13

Horizontal Lock, Zoom menu, 3-39

Horizontal menu, 3-83

Delayed Only, 3-83

Delayed Runs After Main, 3-16, 3-83

Delayed Scale, 3-15

Delayed Triggerable, 3-16, 3-83

FastFrame, 3-47

FastFrame Setup, 3-47

Fit to screen, 3-15

Frame Count, 3-47

Frame Length%, 3-47

Frame%, 3-47

Horiz Pos, 3-16

Horiz Scale, 3-15

Intensified, 3–83, 3–84
Main Scale, 3–15
Record Length, 3–15
Set to 10%, 3–16
Set to 50%, 3–16
Set to 90%, 3–16
Time Base, 3–83
Trigger Position, 3–15
HORIZONTAL MENU button, 3–53, 3–83
Horizontal **POSITION** knob, 3–14, 3–39
Horizontal Readouts, 3–13
Horizontal **SCALE** knob, 3–14, 3–39
HPGL, 3–121
HPGL, Hardcopy menu, 3–122
Hue, Color menu, 3–34

I

I/O, Status menu, 3–133
I/O, Utility menu, 3–122
Independent, Cursor menu, 3–100
Infinite Persistence, Display menu, 3–28
Installation, 1–4
InstaVu, 3–43–3–48, Glossary–5–Glossary–12
InstaVu mode
 How to use, 3–43
 Modes incompatible with, 3–45
 Versus Normal DSO mode (illustrated), 3–44
 Waveform capture rate, 3–43
Integral math waveform, 3–166
 applications, 3–165
 automated measurements of, 3–169
 derivation of, 3–166
 magnifying, 3–165, 3–169
 procedure for displaying, 3–166
 procedure for measuring, 3–167
 record length of, 3–166
Integration, Waveform, 3–165
Intensified Samples, Display menu, 3–28
Intensified, Horizontal menu, 3–83, 3–84
Intensity, Glossary–5
Intensity, Display menu, 3–29–3–48
Interleaf, 3–121
Interleaf, Hardcopy menu, 3–122
Interleaving, 3–19, Glossary–5
Interpolation, 3–18, 3–20, 3–31, Glossary–5
 And zoom, 3–38
 FFT distortion, 3–155
 Incompatible with InstaVu, 3–46
 linear versus $\sin(x)/x$, 3–155
IRE (NTSC), Cursor menu, 3–101

K

Keypad, 2–7, 2–22
Knob, Glossary–6
 General purpose, 2–7, 2–21, Glossary–4
 Horizontal **POSITION**, 2–13, 3–14
 Horizontal **SCALE**, 2–13, 3–14
 Trigger **MAIN LEVEL**, 2–14, 3–53
 Vertical **POSITION**, 2–13, 3–10
 Vertical **SCALE**, 2–13, 3–10

L

Labelling menu, **Enter Char**, 3–118, 3–119
Landscape, Hardcopy menu, 3–122
Laserjet, 3–121
Laserjet, Hardcopy menu, 3–122
Layout, Hardcopy menu, 3–122
Level, Delayed Trigger menu, 3–85
Level, Main Trigger menu, 3–60, 3–74, 3–77
Level, Trigger, 3–53
LF Rej, Main Trigger menu, 3–58
Lightness, Color menu, 3–34
Limit Test Condition Met, Acquire menu, 3–141
Limit Test Setup, Acquire menu, 3–140, 3–141
Limit Test Sources, Acquire menu, 3–140
Limit Test, Acquire menu, 3–141
Limit Testing, Incompatible with InstaVu, 3–45
Limit testing, 3–137–3–170
Linear interpolation, 3–19, 3–31, Glossary–5
Linear interpolation, Display menu, 3–31
Logic trigger, 3–50, 3–62
 Definitions, 3–62
 Pattern, 3–61, Glossary–6
 Readout, 3–64
 State, 3–62, Glossary–6
Logic triggering, 3–60–3–86
Logic, Main Trigger menu, 3–57
Low, 3–89, Glossary–6
Low impedance Z_0 probes, E–2
Low Ref, Measure menu, 3–94

M

Main menu, Glossary–6
Main menu buttons, 2–3, Glossary–6
Main Scale, Horizontal menu, 3–15
Main Trigger Menu
 Falling edge, 3–60
 Rising edge, 3–60

- Main Trigger menu, 3–57, 3–58, 3–64, 3–67, 3–68, 3–72, 3–74, 3–77
- AC**, 3–58
- Accept Glitch**, 3–73
- AND**, 3–66, 3–68
- Auto**, 3–59
- Ch1, Ch2 ...**, 3–58, 3–65, 3–68, 3–69, 3–73, 3–74, 3–76, 3–77
- Class**, 3–76
 - Pattern**, 3–64
 - Runt**, 3–74
 - Setup/Hold**, 3–68
 - Slew Rate**, 3–77
 - State**, 3–67
- Class Glitch**, 3–72
- Clock Source**, 3–69
- Coupling**, 3–58
- Data Source**, 3–68
- DC**, 3–58
- Define Inputs**, 3–65, 3–67, 3–69
- Define Logic**, 3–66, 3–68
- Delta Time**, 3–78
- Edge**, 3–57, 3–58
- Either**, 3–73, 3–74, 3–77
- Falling edge, 3–68, 3–69
- Glitch**, 3–73
- Goes FALSE**, 3–66, 3–68
- Goes TRUE**, 3–66, 3–68
- HF Rej**, 3–58
- Level**, 3–60, 3–74, 3–77
- LF Rej**, 3–58
- Mode & Holdoff**, 3–59
- NAND**, 3–66, 3–68
- Negative**, 3–73, 3–74, 3–77
- Noise Rej**, 3–58
- NOR**, 3–66, 3–68
- Normal**, 3–59
- OR**, 3–66, 3–68
- Polarity**, 3–74, 3–77
- Polarity and Width**, 3–73
- Positive**, 3–73, 3–74, 3–77
- Pulse**, 3–57, 3–74, 3–76
- Reject Glitch**, 3–73
- Rising edge, 3–68, 3–69
- Runt**, 3–74, 3–76
- Set Thresholds**, 3–65, 3–68
- Set to 50%**, 3–54, 3–60, 3–74
- Set to ECL**, 3–60, 3–74, 3–78
- Set to TTL**, 3–60, 3–74, 3–78
- Slope**, 3–60
- Source**, 3–58, 3–73, 3–74, 3–76, 3–77
- State**, 3–67, 3–68
- Thresholds**, 3–75, 3–78
- Trigger When**, 3–66, 3–68, 3–78
- True for less than**, 3–66
- True for more than**, 3–66
- Type**, 3–57, 3–58, 3–76
 - Logic**, 3–64, 3–67, 3–68
 - Pulse**, 3–77
 - Pulse, 3–74
 - Type Pulse**, 3–72
 - Width**, 3–73
- MAIN TRIGGER OUTPUT**, BNC, 2–5
- Map Math**, Color menu, 3–35
- Map Reference**, Color menu, 3–35
- Math waveform
 - derivative. *See* Derivative math waveform
 - FFT. *See* FFT math waveform
 - integral. *See* Integral math waveform
- Math waveforms, 3–144
 - Disallowed in InstaVu, 3–46
- Math**, Color menu, 3–35
- Math1/2/3**, More menu, 3–144
- Maximum, 3–89, Glossary–6
- Mean, 3–89, Glossary–6
- MEASURE** button, 3–90
- Measure Delay menu
 - Create Measrmnt**, 3–95
 - Delay To**, 3–94
 - Edges**, 3–95
 - Measure Delay To**, 3–94
 - OK Create Measurement**, 3–95
- Measure Delay To**, Measure Delay menu, 3–94
- Measure menu, 3–90, 3–95
 - Gating**, 3–91
 - High Ref**, 3–94
 - High-Low Setup**, 3–92
 - Histogram**, 3–92
 - Low Ref**, 3–94
 - Mid Ref**, 3–94
 - Mid2 Ref**, 3–94
 - Min-Max**, 3–92
 - Reference Levels**, 3–93
 - Remove Measrmnt**, 3–91, 3–95
 - Select Measrmnt**, 3–90, 3–94
 - Set Levels in % units**, 3–93
 - Snapshot**, 3–95
- Measurement
 - Amplitude, 3–88, Glossary–1
 - Area, 3–88, Glossary–1
 - Burst width, 3–88, Glossary–2
 - Cycle area, 3–88, Glossary–3
 - Cycle mean, 3–88, Glossary–3
 - Cycle RMS, 3–88, Glossary–3
 - Delay, 3–94, Glossary–3
 - Duty cycle, 2–20, Glossary–6, Glossary–8

- Fall time, 3–88
- Frequency, 2–19, 3–88, Glossary–4
- Gated, Glossary–4
- High, 3–88, Glossary–5
- Low, 3–89, Glossary–6
- Maximum, 3–89, Glossary–6
- Mean, 3–89, Glossary–6
- Minimum, 3–89, Glossary–6
- Negative duty cycle, 3–89
- Negative overshoot, 3–89
- Negative width, 3–89
- Overshoot, Glossary–8
- Peak to peak, 3–89, Glossary–7
- Period, 3–89, Glossary–7
- Phase, 3–89, Glossary–7
- Positive duty cycle, 3–89
- Positive overshoot, 3–89
- Positive width, 3–89
- Propagation delay, 3–88
- Readout, 3–90
- Reference levels, 2–21
- Rise time, 2–20, 3–89, Glossary–9
- RMS, 3–89, Glossary–9
- Undershoot, Glossary–7
- Width, 2–20, Glossary–7, Glossary–8
- Measurement Accuracy, Ensuring maximum, 3–102, 3–104–3–110
- Measurements, 3–87–3–110
 - Algorithms, B–1–B–14
 - Automated, 2–19, 3–87–3–110
 - Classes of, 3–87–3–110
 - Cursor, 3–87–3–110
 - Gated, 3–91
 - Graticule, 3–87–3–110
 - Snapshot of, 3–95
- Measuring Waveforms, 3–87
- Memory, Waveform, 3–115
- Menu
 - Acquire, 3–23, 3–138
 - Color, 3–33
 - Cursor, 3–99
 - Delayed Trigger, 3–83–3–86
 - Display, 3–28, 3–33
 - File Utilities, 3–117
 - Horizontal, 3–53, 3–83
 - Main, 2–6
 - Main Trigger, 3–57, 3–58, 3–64, 3–67, 3–68, 3–72, 3–74, 3–77
 - Measure, 3–90, 3–95
 - More, 3–115, 3–142, 3–146, 3–162
 - See also* More menu
 - Operation, 2–7
 - Pop-up, 2–8, Glossary–8
 - Save/Recall, 3–111
 - Save/Recall Waveform, 3–114
 - Setup, 2–10, 3–7
 - Status, 3–133–3–136
 - Utility, 3–122
- Measurements, List of automated, 3–88
- Mid Ref**, Measure menu, 3–94
- Mid2 Ref**, Measure menu, 3–94
- Min-Max**, Measure menu, 3–92
- Minimum, 3–89, Glossary–6
- Mode & Holdoff**, Main Trigger menu, 3–59
- Model number location, 2–3
- Monochrome**, Color menu, 3–34
- MORE** button, 3–8, 3–115, 3–139, 3–142
- More menu, 3–115, 3–142, 3–162
 - Average**, 3–144
 - Blackman-Harris**, 3–148
 - Change Math waveform definition**, 3–146, 3–162, 3–166
 - dBV RMS**, 3–147
 - diff**, 3–162
 - Dual Wfm Math**, 3–143
 - FFT**, 3–146
 - Hamming**, 3–148
 - Hanning**, 3–148
 - intg**, 3–166
 - Linear RMS**, 3–147
 - Math1, Math2, Math3**, 3–146, 3–162, 3–166
 - Math1/2/3**, 3–144
 - No Process**, 3–144
 - OK Create Math Waveform**, 3–143, 3–166
 - Phase (deg)**, 3–147
 - Phase (rad)**, 3–147
 - Rectangular**, 3–147
 - Reference waveform status, 3–116
 - Set 1st Source to**, 3–143
 - Set 2nd Source to**, 3–143
 - Set FFT Source to:**, 3–146
 - Set FFT Vert Scale to:**, 3–147
 - Set FFT Window to:**, 3–147
 - Set Function to**, 3–143
 - Set Function to:**, 3–162, 3–166
 - Set operator to**, 3–143
 - Set Single Source to**, 3–142, 3–143
 - Set Single Source to:**, 3–162, 3–166
 - Single Wfm Math**, 3–142, 3–162, 3–166

N

- NAND, Glossary–6
- NAND**, Main Trigger menu, 3–66, 3–68
- Negative duty cycle, 3–89

Negative overshoot, 3–89
Negative width, 3–89
Negative, Main Trigger menu, 3–73, 3–74, 3–77
No Process, More menu, 3–144
Noise
 reducing in FFTs, 3–154
 reducing in phase FFTs, 3–148, 3–157
Noise Rej, Main Trigger menu, 3–58
NOR, Glossary–7
NOR, Main Trigger menu, 3–66, 3–68
Normal trigger mode, 3–51, Glossary–7
Normal, Color menu, 3–34
Normal, Main Trigger menu, 3–59
NTSC, Display menu, 3–31
Nyquist frequency, 3–155

O

OFF (Real Time Only), Acquire menu, 3–24
Off Bus, Utility menu, 3–131
Offset
 DC. *See* DC Offset
 Vertical, 3–13
 vertical, 3–153, 3–164, 3–169
Offset, Vertical menu, 3–13
OK Confirm Clear Spool, Hardcopy menu, 3–126
OK Create Math Wfm, More menu, 3–143
OK Create Measurement, Measure Delay menu, 3–95
OK Erase Ref & Panel Memory, Utility menu, 3–113
OK Store Template, Acquire menu, 3–139
ON (Enable ET), Acquire menu, 3–24
ON/STBY button, 1–5, 2–3
Optical probes, E–5
Options, A–1–A–6
Options, Color menu, 3–36
OR, Glossary–7
OR, Main Trigger menu, 3–66, 3–68
Oscilloscope, Glossary–7
Overall, Display menu, 3–29
Overshoot, Glossary–8
Overwrite Lock, File Utilities menu, 3–120

P

P6205 Active Probe, 1–3
Packaging, C–1
Paired cursor, 3–97
PAL, Display menu, 3–31
Palette, Color menu, 3–33
Palette, Hardcopy menu, 3–123
Passive voltage probes, E–1–E–6

Pattern trigger, 3–61
 How to setup, 3–64–3–86
PCX, 3–121
PCX Color, Hardcopy menu, 3–122
PCX, Hardcopy menu, 3–122
Peak detect acquisition mode, 3–22, Glossary–7
Peak Detect, Acquire menu, 3–23
Peak to peak, 3–89, Glossary–7
Period, 3–89, Glossary–7
Persistence, 3–28
Persistence Palette, Color menu, 3–34
Phase, 3–89, Glossary–7
Phase suppression, 3–157
Pixel, Glossary–8
Polarity and Width, Main Trigger menu, 3–73
Polarity, Main Trigger menu, 3–74, 3–77
Pop-up menu, 2–8, Glossary–8
Port, Hardcopy menu, 3–123
Port, Utility menu, 3–131
Portrait, Hardcopy menu, 3–122
Position
 Vertical, 3–11
 vertical, 3–153, 3–164, 3–169
Position, Vertical menu, 3–12
Positive duty cycle, 3–89
Positive overshoot, 3–89
Positive width, 3–89
Positive, Main Trigger menu, 3–73, 3–74, 3–77
Postscript, 3–121
Posttrigger, Glossary–8
Power connector, 1–4, 2–5
Power cords, A–1
Power off, 1–6
Power on, 1–5
Pretrigger, Glossary–8
Preview, Zoom menu, 3–40
Principal power switch, 1–5, 2–5
Print, File Utilities menu, 3–119
Printer (Color), Option 5, A–2
Printing a Hardcopy, Reference Article, 3–120
Probe Cal, 3–104–3–110
Probe usage, 1–3
Probes
 Accessories, A–4
 Active voltage, E–3–E–6
 Compensation, 2–15, Glossary–8
 Compensation of, 3–3
 Compensation Signal, 2–13
 Connection, 2–9
 Current, E–4
 Definition, Glossary–8
 Differential active, E–3

Fixtured active, E-3
 General purpose (high input resistance), E-1
 High speed, E-3
 High voltage, E-2
 Low impedance Z_0 , E-2
 Optical, E-5
 Option 23 to add, A-2
 Option 26 to add, A-2
 P6205 Active, 1-3
 Passive, 3-3
 Passive voltage, E-1-E-6
 Selection, E-1-E-6
 Time-to-voltage converter, E-5
 Product description, 1-1
 Propagation delay, 3-88
 Pulse trigger, 3-50, 3-70
 definition of classes, 3-70
 Pulse triggers, definitions of, 3-71
Pulse, Main Trigger menu, 3-57, 3-74, 3-76

Q

Quantizing, Glossary-8

R

Rack mounting, A-2
 Readout
 Acquisition, 3-23
 Channel, 2-6, 3-8, 3-38
 Cursors, 2-6
 Edge trigger, 3-57
 General purpose knob, 2-6
 Logic trigger, 3-64
 Measurement, 3-90
 Record view, 2-6
 Snapshot, 3-95
 Time base, 2-6
 Trigger, 2-6, 3-55, 3-56
 Trigger Level Bar, 3-29
 Trigger Point, 3-29
 Readout, Cursor, Paired, 3-163
 Readout, cursor
 H-Bars, 3-149, 3-163, 3-167
 Paired cursors, 3-150, 3-168
 V-Bars, 3-149, 3-163, 3-168
Readout, Display menu, 3-29, 3-31
 Real time sampling, 3-17
 Real-time sampling, Glossary-8
 Rear panel, 2-5
 Recall, Setups, 3-111-3-132
Recall Factory Setup, Save/Recall Setup menu, 3-113

Recall Saved Setup, Save/Recall Setup menu, 3-112
 Recalling, Waveforms, 3-114
 Record Length, Limit in Hi Res mode, 3-15
 Record length, 3-15, Glossary-9
 derivative math waveforms, 3-162
 integral math waveforms, 3-166
 Option 1M, A-2
Record Length, Horizontal menu, 3-15
 Record lengths, Incompatible with InstaVu, 3-46
 Record View, 2-6, 3-9, 3-13, 3-56
 Rectangular window, 3-147
Ref, Color menu, 3-36
Ref1, Ref2, Ref3, Ref4, File, Save/Recall Waveform menu, 3-115
Ref1, Ref2, Ref3, Ref4, Reference waveform status, 3-116
 Reference Indicator, Channel, 3-8
 Reference levels, 2-21
 Defining for Measure, 3-93
Reference Levels, Measure menu, 3-93
 Reference memory, Glossary-9
Reject Glitch, Main Trigger menu, 3-73
 Remote communication, 3-128-3-132
 Remote operation
 Communicating with Remote Instruments, 3-128
 Connecting to the GPIB, 3-130
 GPIB interface requirements, 3-129
 GPIB Protocols, 3-129
 Interconnect cabling, 3-130
 Preparation for, 3-129
 Procedures for, 3-130
 Selecting and configuring the port, 3-131
Remove Measrmt, Measure menu, 3-91, 3-95
Rename, File Utilities menu, 3-118
Repetitive Signal, Acquire menu, 3-24
 Reset, How to execute, 3-7-3-48
Reset All Mappings To Factory, Color menu, 3-36
Reset All Palettes To Factory, Color menu, 3-36
Reset Current Palette To Factory, Color menu, 3-36
Reset to Factory Color, Color menu, 3-34
Reset Zoom Factors, Zoom menu, 3-40
Restore Colors, Color menu, 3-36
Ring Bell if Condition Met, Acquire menu, 3-140
 Rise time, 2-20, 3-89, Glossary-9
 Rising edge, Delayed Trigger menu, 3-85
 Rising edge, Main Trigger menu, 3-60, 3-68, 3-69
RLE Color, Hardcopy menu, 3-122
 RMS, 3-89, Glossary-9
 RS-232, 2-5
 RS-232, **Port**, 3-123, 3-128
 RUN/STOP, 3-48
RUN/STOP, Acquire menu, 3-26

Runt trigger, 3-71, 3-72, Glossary-9
How to set up, 3-74-3-86
Runt, Main Trigger menu, 3-74, 3-76

S

Sample acquisition mode, 3-20, Glossary-9
Sample interval, Glossary-9
Sample Rate, Maximum, 3-19
Sample, Acquire menu, 3-23
Sampling, 3-17, Glossary-9
Sampling and acquisition mode, 3-24
Sampling and digitizing, 3-16
Saturation, Color menu, 3-35
Save, Setups, 3-111-3-132
Save Current Setup, Save/Recall Setup menu, 3-111
Save Format, Save/Recall Waveform menu, 3-115
Save Waveform, Save/Recall Waveform menu, 3-114
Save/Recall **SETUP** button, 2-10, 3-7, 3-111, 3-117
Save/Recall Setup menu, 3-111
 factory status, 3-111
 File Utilities, 3-113
 Recall Factory Setup, 3-113
 Recall Saved Setup, 3-112
 Save Current Setup, 3-111
 user status, 3-111
Save/Recall **WAVEFORM** button, 3-114, 3-117
Save/Recall Waveform menu, 3-114
 active status, 3-114
 Autosave, 3-116
 Delete Refs, 3-115
 empty status, 3-114
 File Utilities, 3-117
 Ref1, Ref2, Ref3, Ref4, File, 3-115
 Save Format, 3-115
 Save Waveform, 3-114
Saving, Waveforms, 3-114
Saving and recalling setups, 2-24, 3-111
Saving and recalling waveforms, 3-114
Saving Waveforms and Setups, 3-111
Scale, vertical, 3-153, 3-164, 3-169
seconds, Cursor menu, 3-101
Security bracket, 2-5
SELECT button, 3-100, Glossary-9
Select Measrmnt, Measure menu, 3-90, 3-94
Selected waveform, Glossary-10
Self test, 1-6
Serial number, 2-5
Service Assurance, A-5
Set 1st Source to, More menu, 3-143
Set 2nd Source to, More menu, 3-143
Set Function to, More menu, 3-143
SET LEVEL TO 50% button, 3-54
Set Levels in % units, Measure menu, 3-93
Set operator to, More menu, 3-143
Set Single Source to, More menu, 3-142, 3-143
Set Thresholds, Main Trigger menu, 3-65, 3-68
Set to 10%, Horizontal menu, 3-16
Set to 50%, Delayed Trigger menu, 3-85
Set to 50%, Horizontal menu, 3-16
Set to 50%, Main Trigger menu, 3-54, 3-60, 3-74
Set to 90%, Horizontal menu, 3-16
Set to ECL, Delayed Trigger menu, 3-85
Set to ECL, Main Trigger menu, 3-60, 3-74, 3-78
Set to TTL, Delayed Trigger menu, 3-85
Set to TTL, Main Trigger menu, 3-60, 3-74, 3-78
Set to Zero, Vertical menu, 3-12
Set/Hold Trigger, 3-62
Setting Up for the Examples, 2-9
Settings, Display menu, 3-28, 3-33
Setup menu, 2-10, 3-7
Setup/Hold trigger
 Maximum hold time (NOTE), 3-64
 Negative setup or hold times, 3-63
 Positive setup or hold times, 3-62
 Trigger point location, 3-62
Setup/Hold trigger, 3-61
 How to setup, 3-68-3-86
Setups, Save and recall, 3-111-3-132
Shipping, C-1
Side menu, Glossary-10
Side menu buttons, 2-3, Glossary-10
SIGNAL OUTPUT, BNC, 2-5
Signal Path Compensation, 1-3, 3-102
Sin(x)/x interpolation, 3-19, 3-31, Glossary-5
Sin(x)/x interpolation, Display menu, 3-31
Single Acquisition Sequence, Acquire menu, 3-26
SINGLE TRIG button, 3-26, 3-55
Single Wfm Math, More menu, 3-142
Single-Shot sampling, 3-17
Slew rate setting, How derived, 3-80
Slew Rate Trigger, 3-72
Slew rate trigger, 3-71, Glossary-9, Glossary-10
 600 ps limitation, 3-79-3-86
 7.5 ns limitation, 3-79-3-86
 How to set up, 3-77-3-86
Slope, Glossary-10
Slope, Delayed Trigger menu, 3-85
Slope, Main Trigger menu, 3-60
Slope, Trigger, 3-53
Snapshot, Readout, 3-95
Snapshot of Measurements, 2-23, 3-95
Snapshot, Measure menu, 3-95
Software version, 3-133

- Source**, Delayed Trigger menu, 3–85
- Source**, Main Trigger menu, 3–58, 3–73, 3–74, 3–76, 3–77
- Spectral**, Color menu, 3–34
- Spooler, Hardcopy, 3–126
- Start up, 1–3
- State trigger, 3–61, 3–67–3–86
How to set up, 3–67–3–86
- State**, Main Trigger menu, 3–67, 3–68
- Status, Determining setup, 3–133
- STATUS** button, 3–133
- Status menu, 3–133–3–136
Display, 3–133
Firmware version, 3–133
I/O, 3–133
System, 3–133
Trigger, 3–133
Waveforms, 3–133
- Stop After Limit Test Condition Met**, Acquire menu, 3–140
- Stop After**, Acquire menu, 3–25, 3–141
- Style**, Display menu, 3–28
- Switch, principal power, 1–5, 2–5
- System**, Status menu, 3–133
- System**, Utility menu, 3–122
- ## T
- Talk/Listen Address**, Utility menu, 3–131
- TDS 700A, xiv
- Tek Secure, 3–113, Glossary–10
- Tek Secure Erase Memory**, Utility menu, 3–113
- Temperature compensation, 3–102
- Temperature**, Color menu, 3–34
- Template Source**, Acquire menu, 3–138
- Text/Grat**, Display menu, 3–29
- Thinkjet, 3–121
- Thinkjet**, Hardcopy menu, 3–122
- Thresholds**, Main Trigger menu, 3–75, 3–78
- TIFF, 3–121
- TIFF**, Hardcopy menu, 3–122
- Time base, Glossary–10
- Time Base**, Horizontal menu, 3–83
- Time Units**, Cursor menu, 3–101
- Time-to-voltage converter, E–5
- Tracking**, Cursor menu, 3–100
- Trigger, 3–49–3–86, Glossary–10
AC Line Voltage, 3–50
Auxiliary, 3–50
Coupling, 3–52–3–86
Delay, 3–53
Delayed, 3–81–3–86
Edge, 3–50, 3–57, Glossary–3
Glitch, 3–71, Glossary–4
Holdoff, 3–51
Level, 3–53, Glossary–10
Logic, 3–50, 3–60–3–86
Mode, 3–51
Pattern, 3–61, 3–64–3–86
Position, 3–14, 3–48, 3–52
Pulse, 3–50, 3–70
Readout, 3–55, 3–56
Runt, 3–71, 3–72, Glossary–9
Setup/Hold, 3–61, 3–62, 3–68–3–86
Slew Rate, 3–72, Glossary–9, Glossary–10
Slew rate, 3–71
Slope, 3–53
Source, 3–50
State, 3–61, 3–67–3–86
Status Lights, 3–55
Types, 3–57–3–86
Video, 3–51
Width, 3–71, 3–76
- Trigger Bar, 2–6, 3–48
- Trigger Bar Style**, Display menu, 3–30
- Trigger if Faster Than**, Main Trigger menu, 3–79
- Trigger if Slower Than**, Main Trigger menu, 3–79
- Trigger Level Bar, Readout, 3–29, 3–48
- Trigger **MAIN LEVEL** knob, 2–14, 3–53, 3–54
- TRIGGER MENU** button, 3–57, 3–58, 3–64, 3–67, 3–68, 3–72, 3–74, 3–77
- Trigger Point, Readout, 3–29, 3–48
- Trigger Position**, Horizontal menu, 3–15
- Trigger Status Lights, 3–55
- Trigger When**, Main Trigger menu, 3–66, 3–68, 3–78
- Trigger, delayed, How to set up, 3–83
- Trigger, edge, How to set up, 3–58–3–86
- Trigger, glitch, How to set up, 3–72–3–86
- Trigger, runt, How to set up, 3–74–3–86
- Trigger, slew rate, How to set up, 3–77–3–86
- Trigger**, Status menu, 3–133
- Trigger, width, How to set up, 3–76–3–86
- Triggering on Waveforms, 3–49
- Triggering, Auto mode, Incompatible with InstaVu, 3–45
- True for less than**, Main Trigger menu, 3–66
- True for more than**, Main Trigger menu, 3–66
- Type Logic**, Main Trigger menu
Logic, 3–64, 3–67, 3–68
Pulse, 3–77
- Type Pulse**, Main Trigger menu, 3–72

Type, Main Trigger menu, 3–57, 3–58, 3–76
Pulse, 3–74

U

Undershoot, Glossary–7

user, Saved setup status, 3–111

UTILITY button, 3–103, 3–122, 3–131

Utility Menu

OK Erase Ref & Panel Memory, 3–113

Tek Secure Erase Memory, 3–113

Utility menu, 3–122

Configure, 3–122, 3–131

GPIB, 3–131

Hardcopy, 3–131

Hardcopy (Talk Only), 3–122

I/O, 3–122

Off Bus, 3–131

Port, 3–131

System, 3–122

Talk/Listen Address, 3–131

V

V Limit, Acquire menu, 3–139

Variable Persistence, Display menu, 3–28

Vectors, 3–28

Vectors display, Incompatible with InstaVu, 3–46

Vectors, Display menu, 3–28

Vertical

Bar cursors, 3–97, Glossary–10

Offset, 3–13

Position, 3–10–3–48

Readout, 3–10

Scale, 3–10

SCALE knob, 2–13, 3–10

System, 2–13

Vertical Menu, **Cal Probe**, 3–104

Vertical menu

20 MHz, 3–12

250 MHz, 3–12

Bandwidth, 3–12

Coupling, 3–12

Fine Scale, 3–12

Full, 3–12

Offset, 3–13

Position, 3–12

Set to Zero, 3–12

VERTICAL MENU button, 2–17

Vertical position, for DC correction of FFTs, 3–153

Vertical **POSITION** knob, 3–10, 3–38

Vertical Readout, 3–10

Vertical **SCALE** knob, 3–10, 3–38

VGA Output, 2–5

Video Line Number, Cursor menu, 3–101

Video Trigger, Option 5, A–1

Video trigger, 3–51

View Palette, Color menu, 3–34

W

Waveform, Glossary–10

Acquiring and Displaying of, 3–3

Autoset on, 3–5–3–48

Coupling to the oscilloscope, 3–3

Interval, Glossary–11

Math, 3–142–3–170

Measuring, 3–87

Priority for turning off, 3–9

Save Formats, 3–115

Saving, 3–111

Triggering on, 3–49

Waveform clipping. *See* Clipping

Waveform differentiation, 3–161

Waveform FFTs, 3–144

Waveform integration, 3–165

Waveform memory, 3–115

WAVEFORM OFF button, 2–18, 3–8, 3–32

Waveform record

FFT, 3–150

FFT frequency domain, 3–151

length of, 3–151

FFT source, 3–150

acquisition mode, 3–154

defined, 3–151

long versus short, 3–153

FFT time domain, 3–151–3–152

Waveform, Display menu, 3–29

Waveforms

And zoom, 3–37

Math, 3–144

Scaling and positioning, 3–9

Waveforms, Status menu, 3–133

Width, 2–20, Glossary–7, Glossary–8

Width trigger, 3–71, 3–76

How to set up, 3–76–3–86

Width, Main Trigger menu, 3–73

Window, 3–158

Blackman-Harris, 3–148, 3–158, 3–161

characteristics of, 3–160

Hamming, 3–148, 3–158, 3–161

Hanning, 3–148, 3–158, 3–161

rectangular, 3–147, 3–158, 3–161

rectangular vs. bell-shaped, 3–160

selecting, 3–158
Windowing, process, 3–158
Windows, descriptions of, 3–147–3–148

X

XY
Format, 3–31
Incompatible with InstaVu, 3–45
XY format, Glossary–11
XY, Display menu, 3–31

Y

YT, Format, 3–31
YT format, Glossary–11
YT, Display menu, 3–31

Z

Zero phase reference point, 3–151, 3–156
establishing for impulse testing, 3–156–3–157

Zoom, 3–37–3–48
And interpolation, 3–38
And waveforms, 3–37
derivative math waveforms, 3–165
Dual Window mode, 3–40
Dual Zoom, 3–41
Dual Zoom Offset, 3–41
Horizontal lock, 3–39
Incompatible with InstaVu, 3–45
on FFT math waveforms, 3–154
on integral math waveforms, 3–169
ZOOM button, 3–38
Zoom feature, 3–37
Zoom menu
Dual Zoom, 3–41
Dual Zoom Offset, 3–41
Horizontal Lock, 3–39
Preview, 3–40
Reset Zoom Factors, 3–40
Zoom Off, 3–40
Zoom Off, Zoom menu, 3–40

