

Precision waveform measurement essentials

Probes and accessories for oscilloscopes

Precision Making

Bulletin Waveform-Acc-01EN

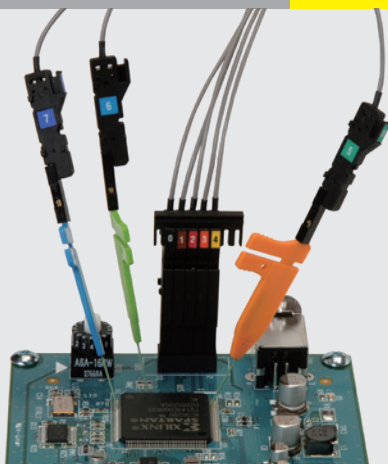

Valid waveform measurement results

An oscilloscope or ScopeCorder is only half the waveform measurement solution. The probe, its interaction with the measuring instrument, and how it is connected to the circuit under test can dramatically affect the quality and validity of the results.

Yokogawa Test&Measurement provides engineering professionals a wide range of accessories that address diverse measurement needs.

■ Probes

To support a broad range of measurement applications, our Precision Makers have developed probes for general purpose use, active probes for high-speed waveform observation, high-voltage differential types for floating power electronics signals, current probes that range from 1 mA to 500 A, and more.

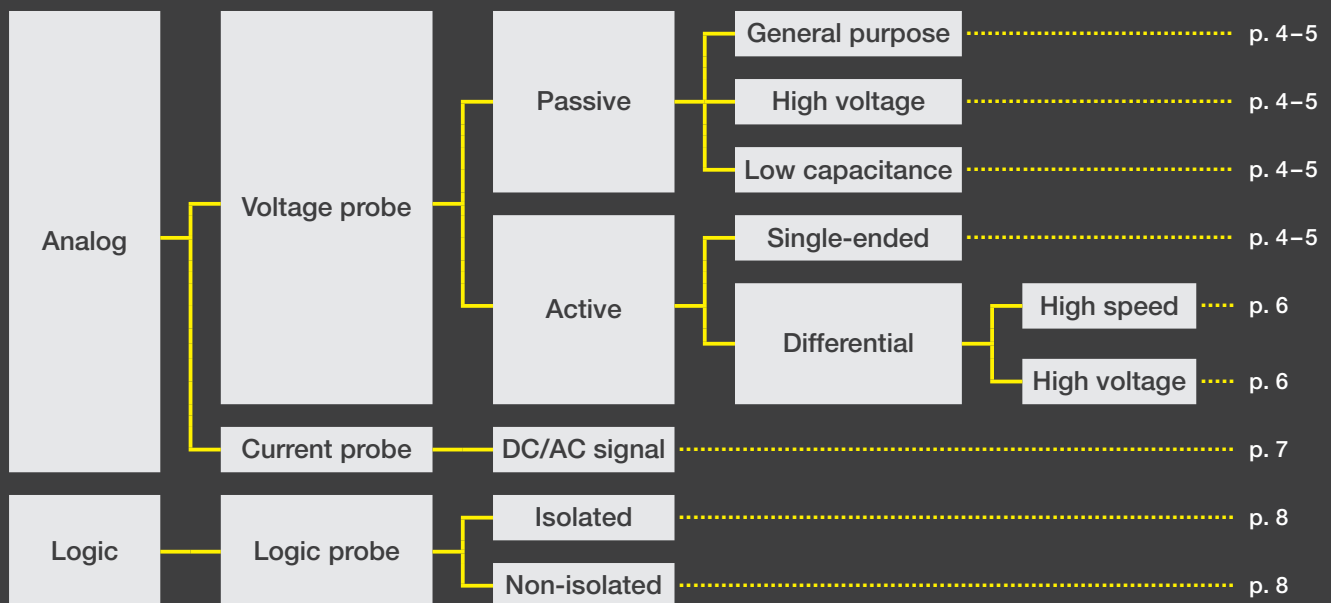

■ Others

- High-voltage Measurement Accessories p. 9
- Cables/Adapters, ScopeCorder accessories, Others p. 10
- Software p. 11

Passive probe chart

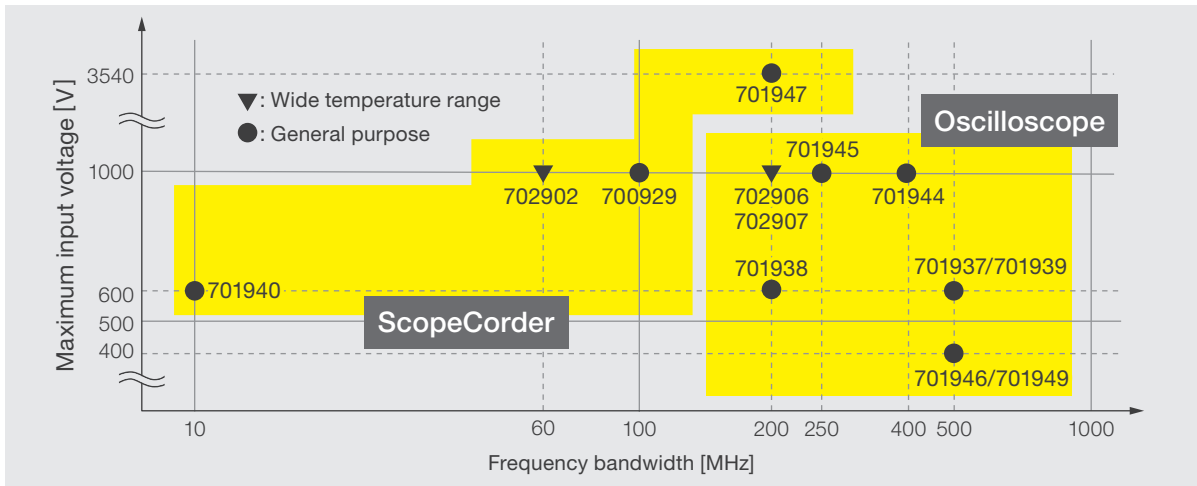

Differential, FET, and low capacitance probe chart

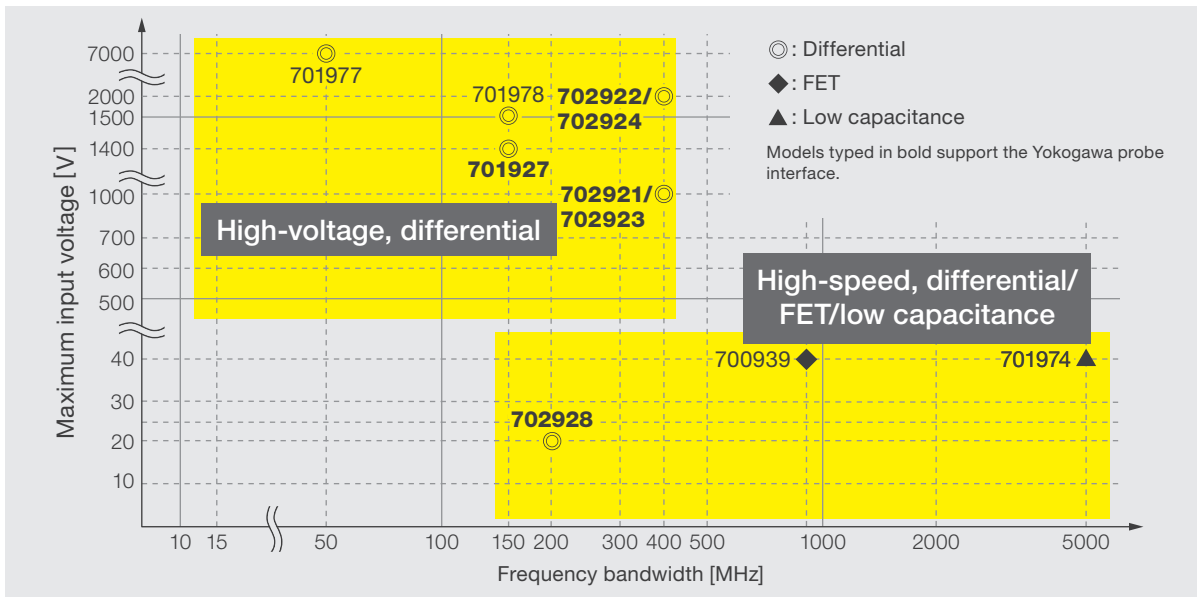

Current probe chart

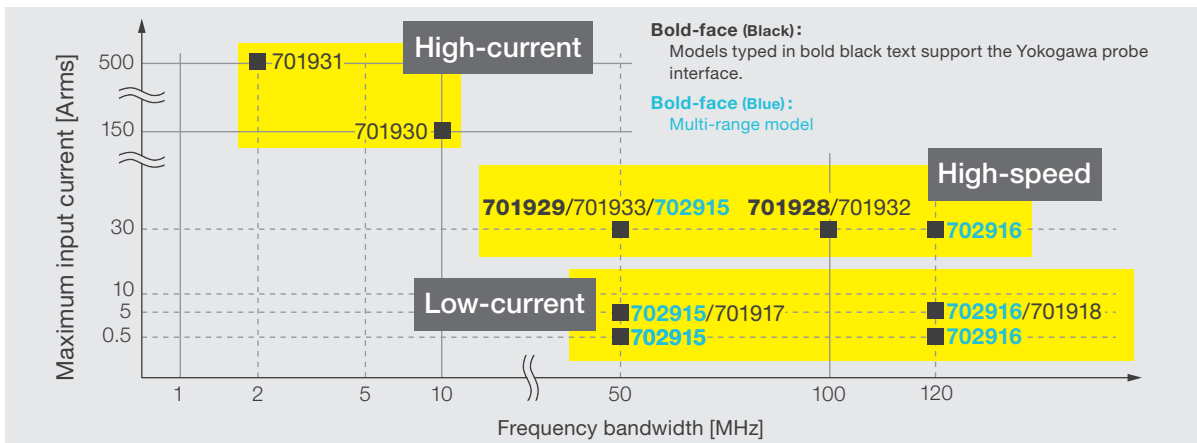









Voltage probes

Passive/FET/Low capacitance

The most basic probe, a passive probe, is also the most versatile. When used with select attachments, passive probes can be used with higher-speed signals. Additionally, Yokogawa Test&Measurement provides probes for extreme cases including high-voltage, wide temperature ranges, and high-speed signal measurement.

For oscilloscope

| <p>701937 500 MHz passive probe</p>  <p>10:1 passive probe for DLM3000/3000HD/5000/5000HD. Included as a standard accessory.</p> | <p>701949 Miniature passive probe</p>  <p>10:1 miniature passive probe for DLM3000/3000HD/5000/5000HD. A wide variety of accessories are included as standard.</p> | <p>702907 10:1 passive probe (Wide operating temperature range)</p>  <p>200 MHz passive probe for DLM3000/3000HD/5000/5000HD with a wider operating temperature range (-40 to 85°C) and total length of 2.5 m.</p> | <p>701938/701939 200 MHz/500 MHz passive probe</p>  <p>10:1 passive probe for DLM2000/4000/6000 and DL6000. Included as a standard accessory.</p> | <p>701946 500 MHz miniature passive probe</p>  <p>10:1 miniature passive probe for DL6000 and DLM2000/4000/6000. Included are the set of accessories useful for probing ICs and high-density PCBs.</p> | | | | | | | | | | | | | | | |
|---|--|---|---|--|--------------|--------|---------|-------|--------|---------|-------|--|--|-----------------------|-----------------------|---------------------|---------|--------------|-------|
| <p>702906 10:1 passive probe (Wide operating temperature range)</p>  <p>10:1 passive probe with a wider operating temperature range (-40 to 85°C) and longer total length than normal passive probes. Suitable for temperature cycling tests.</p> | <p>701943 (PB500) 500 MHz passive probe</p>  <p>10:1 passive probe for DL9000/9500/9700 and SB5000.</p> | <p>701944/701945 100:1 high voltage probe</p>  <p>100:1 passive probe for high voltage measurement up to 1000 Vrms.</p> <table border="1" data-bbox="667 1310 922 1393"> <thead> <tr> <th></th> <th>Frequency bandwidth</th> <th>Cable length</th> </tr> </thead> <tbody> <tr> <td>701944</td> <td>400 MHz</td> <td>1.2 m</td> </tr> <tr> <td>701945</td> <td>250 MHz</td> <td>3.0 m</td> </tr> </tbody> </table> | | Frequency bandwidth | Cable length | 701944 | 400 MHz | 1.2 m | 701945 | 250 MHz | 3.0 m | <p>700939 FET probe</p>  <p>The input resistance is higher than other types of active probe. A probe power supply is required.</p> | <p>701974 5 GHz low capacitance probe</p>  <p>Probe with low input capacitance and low input resistance.</p> <table border="1" data-bbox="1228 1310 1484 1393"> <tbody> <tr> <td>Maximum input voltage</td> <td>20 Vrms 40 VACpeak</td> </tr> <tr> <td>Frequency bandwidth</td> <td>5.0 GHz</td> </tr> <tr> <td>Total length</td> <td>1.0 m</td> </tr> </tbody> </table> | Maximum input voltage | 20 Vrms 40 VACpeak | Frequency bandwidth | 5.0 GHz | Total length | 1.0 m |
| | Frequency bandwidth | Cable length | | | | | | | | | | | | | | | | | |
| 701944 | 400 MHz | 1.2 m | | | | | | | | | | | | | | | | | |
| 701945 | 250 MHz | 3.0 m | | | | | | | | | | | | | | | | | |
| Maximum input voltage | 20 Vrms 40 VACpeak | | | | | | | | | | | | | | | | | | |
| Frequency bandwidth | 5.0 GHz | | | | | | | | | | | | | | | | | | |
| Total length | 1.0 m | | | | | | | | | | | | | | | | | | |

The specified frequency bandwidth of a passive probe is the system bandwidth (-3 dB) when used with the related oscilloscope. The specified bandwidths of FET and active probes are for the probe only. The maximum input voltage is limited by the frequency of the measurement signal.

Passive probe selection guide (Oscilloscopes)

| Model (Name) | Frequency bandwidth ¹ | Maximum input voltage ² | Attenuation ratio | Input resistance ³ /capacitance ⁴ | Total length | Notes |
|----------------|----------------------------------|------------------------------------|-------------------|---|--------------|--|
| 701937 | 500 MHz | 600 V (DC + ACpeak) | 10:1 | 10 MΩ/approx. 10.5 pF | 1.3 m | 600 V (DC + ACpeak) CAT II, For DLM3000/3000HD/5000/5000HD |
| 701938 | 200 MHz | 600 V (DC + ACpeak) | 10:1 | 10 MΩ/approx. 13.5 pF | 1.5 m | 600 V (DC + ACpeak) CAT II, For DLM2000 (200 MHz models) |
| 701939 | 500 MHz | 600 V (DC + ACpeak) | 10:1 | 10 MΩ/approx. 10.5 pF | 1.3 m | 600 V (DC + ACpeak) CAT II, For DL6000, DLM2000 (350/500 MHz models), DLM4000/6000 |
| 701943 (PB500) | 500 MHz | 600 V (DC + ACpeak) | 10:1 | 10 MΩ/approx. 12.5 pF | 1.5 m | 600 V (DC + ACpeak) CAT II, For DL9000/9500/9700, SB5000 |
| 701944 | 400 MHz | 1000 Vrms | 100:1 | 50 MΩ/approx. 7.5 pF | 1.4 m | 1000 Vrms CAT II, 4000 Vpeak |
| 701945 | 250 MHz | 1000 Vrms | 100:1 | 50 MΩ/approx. 7.5 pF | 3.2 m | 1000 Vrms CAT II, 4000 Vpeak |
| 701946 | 500 MHz | 400 Vrms | 10:1 | 10 MΩ/approx. 9.5 pF | 1.4 m | Miniature passive probe, 1250 Vpeak, 300 Vrms CAT II, For DL6000, DLM2000/4000/6000 |
| 701949 | 500 MHz | 400 Vrms | 10:1 | 10 MΩ/approx. 9.5 pF | 1.5 m | Miniature passive probe, 1250 Vpeak, 300 Vrms CAT II, For DLM3000/3000HD/5000/5000HD |
| 702906 | 200 MHz | 1000 V (DC + ACpeak) | 10:1 | 10 MΩ/approx. 16 pF | 2.5 m | 1000 V (DC + ACpeak) CAT II, Wide operating temperature (-40 to +85°C), For DLM2000/4000 |
| 702907 | 200 MHz | 1000 V (DC + ACpeak) | 10:1 | 10 MΩ/approx. 18.0 pF | 2.5 m | 1000 V (DC + ACpeak) CAT II, Wide operating temperature (-40 to +85°C), For DLM3000/3000HD/5000/5000HD |

¹: DC to -3 dB point ²: Depending on the frequency of the measurement signal ³: In combination with corresponding oscilloscopes ⁴: Defined from the probe tip

FET probes, low capacitance probes selection guide (Oscilloscopes)

| Model (Name) | Frequency bandwidth ^{1, 2} | Maximum input voltage ³ | Maximum nondestructive voltage ³ | Attenuation ratio | Input resistance ² /capacitance ⁴ | Total length | Recommended instruments | Power supply |
|------------------|-------------------------------------|------------------------------------|---|-------------------|---|--------------|--|--------------------|
| 700939 | 900 MHz | ±10 V (DC + ACpeak) | ±40 V (DC + ACpeak) | 10:1 | 2.5 MΩ/approx. 1.8 pF | 1.5 m | All YOKOGAWA's oscilloscopes | Probe power supply |
| 701974 (PBL5000) | 5 GHz | 20 Vrms | 40 VACpeak | 10:1, 20:1 | 450 Ω/approx. 0.25 pF 950 Ω/approx. 0.4 pF | 1.0 m | DL6000/9000 (The instrument of 50 Ω input impedance) | Not required |

¹: DC to -3 dB point ²: Defined by a probe only ³: Depending on the frequency of the measurement signal ⁴: Defined from the probe tip

For ScopeCorder (with isolated BNC inputs)

For safety, metals part of the probe body and the BNC connector are insulated except the probe tip.

702902

10:1 passive probe
(Wide operating temperature range)



10:1 passive probe for isolated input modules for the ScopeCorder series having a wider operating temperature range (-40 to 85°C) and total length of 2.5 m. Suitable for temperature cycling tests.

700929

10:1 probe (Safety probe—for use with isolated input modules)



10:1 passive probe for an isolated input module for the ScopeCorder series. The frequency bandwidth is 100 MHz.

701947

100:1 probe (Safety probe—for use with isolated input modules)



100:1 passive probe for an isolated input module for the ScopeCorder series. The frequency bandwidth is 200 MHz.

The frequency bandwidth is DC to -3 dB point. The system bandwidth always depends on the instrument used. The maximum input voltage is limited by the frequency of the measurement signal.

Passive probe selection guide (ScopeCorders: Isolated input module)

| Model (Name) | Frequency bandwidth ^{*1} | Maximum input voltage ^{*2} | Attenuation ratio | Input resistance ^{*3} / capacitance ^{*4} | Total length | Notes |
|--------------|-----------------------------------|-------------------------------------|-------------------|---|--------------|--|
| 702902 | 60 MHz | 1000 V (DC + ACpeak) | 10:1 | 10 MΩ/approx. 17 pF | 2.5 m | 1000 V (DC + ACpeak) CAT II Wide operating temperature (-40 to +85°C) |
| 700929 | 100 MHz | 1000 V (DC + ACpeak) | 10:1 | 10 MΩ/approx. 18 pF | 1.7 m | 1000 V (DC + ACpeak) CAT II, 600 Vrms, CAT III |
| 701947 | 200 MHz | 3540 V (DC + ACpeak) | 100:1 | 100 MΩ/approx. 7 pF | 1.7 m | 3540 V (DC + ACpeak) ^{*5} , 1000 V (DC + ACpeak) CAT II |

*1: DC to -3 dB point, the system bandwidth always depends on the instrument used *2: Depending on the frequency of the measurement signal *3: In combination with corresponding input modules
*4: Defined from the probe tip. *5: The measurement category is Other (O). Do not use it to measure the main power supply or for Measurement Categories II, III, and IV.

Passive probe selection guide (ScopeCorders: Non-isolated input module)

| Model (Name) | Frequency bandwidth ^{*1} | Maximum input voltage ^{*2} | Attenuation ratio | Input resistance ^{*3} / capacitance ^{*4} | Total length | Notes |
|--------------|-----------------------------------|-------------------------------------|-------------------|---|--------------|-------|
| 701940 | 10 MHz | 600V (DC + ACpeak) | 1:1, 10:1 | 10 MΩ/approx. 22 pF (@10:1) | 1.5 m | |

*1: DC to -3 dB point, the system bandwidth always depends on the instrument used *2: Depending on the frequency of the measurement signal *3: In combination with corresponding input modules
*4: Defined from the probe tip.

Probe accessories

366946 Solder-in adapter

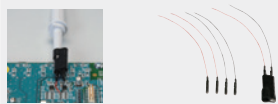

For 701937, 701938, 701939, 701943 (PB500) and 700939
Standard accessories include:
Adapter, red wire (3), black wire (3)
*Unsafe for voltage measurements above 42 V.

701948 Plug on clip



Connected to the 700929 and 701947
Maximum input voltage:
1000 V (DC + ACpeak)
Length: 0.26 m/0.3 m/0.4 m

700971 Mini clip converter



A clip set designed for 701937, 701938, 701939, 701943 (PB500) and 700939
*Unsafe for voltage measurements above 42 V.

700972 BNC adapter



For 701937, 701938, 701939, 701943 (PB500) and 700939.
*Unsafe for voltage measurements above 42 V.

366945 Printed circuit board adapter

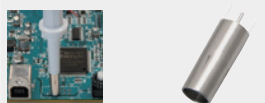

For 701937, 701938, 701939, 701943 (PB500) and 700939.
Quantity of 1 unit: 10
*Unsafe for voltage measurements above 42 V.

B8099NL 4 mm conversion adapter



Conversion adapters for 702902, 702906 and 702907 probes. Used for connecting to the high voltage measurement terminal adapters. (Pincher tip end)

B8099NM 4 mm conversion adapter









Conversion adapters for 702902, 702906 and 702907 probes. Used for connecting to the high voltage measurement terminal adapters. (Ground lead end)

Voltage probes

Differential probes

For measuring floating and high-speed differential signals in combination with single-ended input oscilloscopes.

| | | |
|--|---|--|
| 702921 (PBDH0400) Maximum ± 1000 Vpeak/400 MHz 702922 (PBDH0400) Maximum ± 2000 Vpeak/400 MHz | 702923 Maximum ± 1000 Vpeak/400 MHz 702924 Maximum ± 2000 Vpeak/400 MHz | 701977 Maximum ± 7000 Vpeak/50 MHz |
|  <p>A wide-bandwidth, high-voltage differential probe with a wide frequency bandwidth, excellent frequency response flatness, and superior CMRR characteristics. The attenuation ratio is switchable between 50:1/500:1(702921), 100:1/1000:1(702922) which is recognized by the YOKOGAWA probe interface that also provides power.</p> |  <p>A wide-bandwidth, high voltage differential probe with a wide frequency bandwidth, excellent frequency response flatness, and superior CMRR characteristics. The attenuation ratio is switchable between 50:1/500:1(702923), 100:1/1000:1(702924).</p> |  <p>High voltage differential probe for floating measurements. The attenuation ratio is switchable between 100:1 and 1000:1.</p> |
| 701978 Maximum ± 1500 Vpeak/150 MHz | 701927 (PBDH0150) Maximum ± 1400 Vpeak/150 MHz | 702928 (PBD0200) Maximum ± 20 Vpeak/200 MHz |
|  <p>Wide-bandwidth and high voltage differential probe for floating measurements. The attenuation ratio is switchable between 50:1 and 500:1. 100 MHz bandwidth is still maintained when using the 1 m probe tip extension cables.</p> |  <p>High-voltage/wide-bandwidth differential probe with the YOKOGAWA probe interface. The attenuation ratio is switchable between 50:1 and 500:1 which is recognized by the probe interface that also provides power. 100 MHz bandwidth is still maintained when using the 1 m probe tip extension cables.</p> |  <p>Capable of measuring up to 200 MHz and ± 20 V, compatible with the YOKOGAWA probe interface. When connected to a supported instrument, the interface enables automatic probe recognition and power supply. It is ideal for measuring automotive bus signals.</p> |

Differential probe selection guide*3, *4

| Model (Name) | Frequency bandwidth ^{*1, *2} | Attenuation ratio | Maximum allowed differential voltage | Maximum input voltage | Power supply |
|-------------------|---------------------------------------|-------------------|--|-----------------------------------|--------------------|
| 701927 (PBDH0150) | 150 MHz | 500:1 50:1 | 500:1 ± 1400 V (DC + ACpeak) 50:1 ± 140 V (DC + ACpeak) | ± 1400 V (DC + ACpeak) CAT II | YOKOGAWA probe I/F |
| 701977 | 50 MHz | 1000:1 100:1 | 1000:1 5000 Vrms and 7000 Vpeak 100:1 500 Vrms and 700 Vpeak | 5000 Vrms and 7000 Vpeak | Probe power supply |
| 701978 | 150 MHz | 500:1 50:1 | 500:1 ± 1500 V (DC + ACpeak) 50:1 ± 150 V (DC + ACpeak) | ± 1500 V (DC + ACpeak) | Probe power supply |
| 702921 (PBDH0400) | 400 MHz | 500:1 50:1 | 500:1 ± 1000 V (DC + ACpeak) 50:1 ± 100 V (DC + ACpeak) | ± 1000 V (DC + ACpeak) | YOKOGAWA probe I/F |
| 702922 (PBDH0400) | 400 MHz | 1000:1 100:1 | 1000:1 ± 2000 V (DC + ACpeak) 100:1 ± 200 V (DC + ACpeak) | ± 2000 V (DC + ACpeak) | YOKOGAWA probe I/F |
| 702923 | 400 MHz | 500:1 50:1 | 500:1 ± 1000 V (DC + ACpeak) 50:1 ± 100 V (DC + ACpeak) | ± 1000 V (DC + ACpeak) | Probe power supply |
| 702924 | 400 MHz | 1000:1 100:1 | 1000:1 ± 2000 V (DC + ACpeak) 100:1 ± 200 V (DC + ACpeak) | ± 2000 V (DC + ACpeak) | Probe power supply |
| 702928 (PBD0200) | 200 MHz | 10:1 | ± 20 V (DC + ACpeak) | ± 60 V DC, ± 42 V ACpeak | YOKOGAWA probe I/F |



*1: DC to -3 dB point *2: Defined by a probe only

*3: This product has not been designed or manufactured for applications in which high reliability is required over a long time period. This probe is not water or dust resistant. Do not use the probe in areas with a lot of dust or where water may be spilled.

*4: The maximum input voltage depends on the input signal frequency.

Current probes

For measuring high and low currents

| | | | | | | | | | | | | | | |
|--|---|---|-----------------------------------|---|----------------|--------------|----------------------|--|----------------------|---------------------------|---------------------|---------------------------------------|--------|----------------|
| <p>701930 DC to 10 MHz, 150 A 701931 DC to 2 MHz, 500 A</p>  <p>For measuring the high current of a power device, a motor, or inverter drive without breaking the circuit.</p> | <p>702915 DC to 50 MHz, 30 A/5 A/0.5 A 702916 DC to 120 MHz, 30 A/5 A/0.5 A</p>  <p>A current probe with three switchable input ranges: 30 A, 5 A, and 0.5 A. For measuring standby current of home appliances, ECUs, industrial equipment, and inrush current of motors and generators.</p> | <p>701932 DC to 100 MHz, 30 A 701933 DC to 50 MHz, 30 A</p>  <p>For measuring higher speed current waveforms without breaking the circuit.</p> | | | | | | | | | | | | |
| <p>701928 (PBC100) DC to 100 MHz, 30 A 701929 (PBC050) DC to 50 MHz, 30 A</p>  <p>Similar to the 701932/701933 with the YOKOGAWA probe interface. This probe is automatically recognized by a DLM series oscilloscope which also provides power.</p> | <p>701917 DC to 50 MHz, 5 A 701918 DC to 120 MHz, 5 A</p>  <p>A low noise probe for low current measurement for LED drive circuits, small motors, and more.</p> | <p>701934*1 Probe power supply</p>  <p>A power supply for current probes, FET probes, and differential probes. Provides power for up to four probes, including large current probes.</p> | | | | | | | | | | | | |
| <p>/Px option*1 Probe power option</p>  <p>Built-in probe power terminals on the main unit can be used to power current probes, FET probes, and differential probes (/P2, /P4 and /P8 option).</p> | <p>701936 Deskew correction signal source</p>  <p>To enable the skew between voltage and current inputs to be adjusted.</p> | <table border="1"> <tbody> <tr> <td>Number of power supply connectors</td> <td>4</td> </tr> <tr> <td>Output voltage</td> <td>±12 V ±0.5 V</td> </tr> <tr> <td>Rated output current</td> <td>+12 V: 2.5 A, -12 V: 2.5 A (the total value of four outputs)</td> </tr> <tr> <td>Rated supply voltage</td> <td>AC100 to 240 V (50/60 Hz)</td> </tr> <tr> <td>External dimensions</td> <td>Approx. 80 (W) × 119 (H) × 200 (D) mm</td> </tr> <tr> <td>Weight</td> <td>Approx. 1.2 kg</td> </tr> </tbody> </table> | Number of power supply connectors | 4 | Output voltage | ±12 V ±0.5 V | Rated output current | +12 V: 2.5 A, -12 V: 2.5 A (the total value of four outputs) | Rated supply voltage | AC100 to 240 V (50/60 Hz) | External dimensions | Approx. 80 (W) × 119 (H) × 200 (D) mm | Weight | Approx. 1.2 kg |
| Number of power supply connectors | 4 | | | | | | | | | | | | | |
| Output voltage | ±12 V ±0.5 V | | | | | | | | | | | | | |
| Rated output current | +12 V: 2.5 A, -12 V: 2.5 A (the total value of four outputs) | | | | | | | | | | | | | |
| Rated supply voltage | AC100 to 240 V (50/60 Hz) | | | | | | | | | | | | | |
| External dimensions | Approx. 80 (W) × 119 (H) × 200 (D) mm | | | | | | | | | | | | | |
| Weight | Approx. 1.2 kg | | | | | | | | | | | | | |

*1: Probes with the YOKOGAWA probe I/F such as the 701927, 701928 and 701929 do not require a /Px option and 701934 since power is supplied from the front panel.

Current probes selection guide*6

| Model (Name) | Frequency bandwidth ¹ | Maximum continuous input range ² | Maximum peak current value ² | Amplitude accuracy ³ | Total length | Noise ⁴ | Power supply ⁵ |
|-----------------|----------------------------------|---|---|---------------------------------|--------------|--------------------|---------------------------|
| 701917 | 50 MHz | 5 Arms | 7.5 Apeak | 3% | 1.7 m | 75 μArms or less | Probe power supply |
| 701918 | 120 MHz | 5 Arms | 7.5 Apeak | 3% | 1.7 m | 75 μArms or less | Probe power supply |
| 701928 (PBC100) | 100 MHz | 30 Arms | 50 Apeak | 1% | 1.7 m | 2.5 mArms or less | YOKOGAWA probe I/F |
| 701929 (PBC050) | 50 MHz | 30 Arms | 50 Apeak | 1% | 1.7 m | 2.5 mArms or less | YOKOGAWA probe I/F |
| 701930 | 10 MHz | 150 Arms | 300 Apeak | 1% | 2.2 m | 25 mArms or less | Probe power supply |
| 701931 | 2 MHz | 500 Arms | 700 Apeak | 1% | 2.2 m | 25 mArms or less | Probe power supply |
| 701932 | 100 MHz | 30 Arms | 50 Apeak | 1% | 1.7 m | 2.5 mArms or less | Probe power supply |
| 701933 | 50 MHz | 30 Arms | 50 Apeak | 1% | 1.7 m | 2.5 mArms or less | Probe power supply |
| 702915 | 50 MHz | 30 Arms | 50 Apeak | 3% | 2.0 m | 75 μArms or less | Probe power supply |
| 702916 | 120 MHz | 30 Arms | 50 Apeak | 3% | 2.0 m | 75 μArms or less | Probe power supply |

*1: DC to -3 dB point, defined by a probe only

*2: Depending on the input signal frequency. See the following website for details: <https://tmi.yokogawa.com/solutions/products/oscilloscopes/current-probes/#Details_Frequency-Derating>

*3: The condition is under the maximum continuous input and DC or 45 to 66 Hz. The amplitude accuracy of a brand-new 701917/701918 is typically 1%.

*4: When used together with a measuring instrument with 20 MHz bandwidth. (30 MHz for the 701917/701918).





*5: The number of probes is limited when using a DL probe power terminal. Please refer to "Relationship between power supply and maximum measurement current" on the web page.

<<https://tmi.yokogawa.com/solutions/products/oscilloscopes/current-probes/#Details>>

*6: Output ratios: 701917/701918 = 1 V/A, 701928/701929/701932/701933 = 0.1 V/A, 701930/701931 = 0.01 V/A, 702915/702916 = 0.1 V/A (30 A range), 1 V/A (5 A range), 10 V/A (0.5 A range).

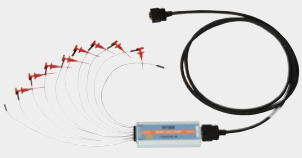
Logic probes and accessories

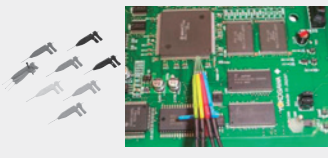
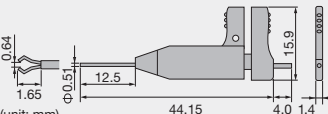
For oscilloscopes



| | | | |
|---|--|---|--|
| <p>701988 (PBL100) High input impedance logic probe</p>  <p>Maximum toggle frequency: 100 MHz Input impedance (typical value): 1 MΩ/10 pF</p> | <p>701989 (PBL250) High speed logic probe</p>  <p>Maximum toggle frequency: 250 MHz Input impedance (typical value): 100 kΩ/3 pF</p> | <p>B9852ES IC clip</p>  <p>By attaching to the tips of logic probe (701988 or 701989), the IC clips can be used to clip contiguous 0.5 mm pitch terminals. A total of 10 clips are included.</p>  <p>(unit: mm)</p> | <p>701909 Logic probe accessory kit</p>  <p>Logic probe accessory kit for use with 701989.</p> |
|---|--|---|--|

Logic probe selection guide (for oscilloscopes)

| Model (Name) | Inputs | Input voltage range | Input impedance | Maximum input voltage | Threshold level | Note |
|-----------------|--------|--|--------------------|--------------------------------|--|---|
| 701988 (PBL100) | 8 | ±40 V | 1 MΩ/10 pF (Typ.) | ±42 V (DC + ACpeak) or 29 Vrms | ±40 V at 0.05 V resolution ^{*1} | Maximum toggle frequency is 100 MHz. |
| 701989 (PBL250) | 8 | ±6 V mainly on a setting threshold level | 100 kΩ/3 pF (Typ.) | ±40 V (DC + ACpeak) or 28 Vrms | ±6 V at 0.05 V resolution ^{*1} | Maximum toggle frequency is 250 MHz. Related accessory: 701909 |

*1: When it is used with DLM2000/3000/4000/5000

For ScopeCorders

| | | |
|---|--|--|
| <p>700986 High speed logic probe (TTL)</p>  <p>8 bit non-isolated inputs. Two measurement leads (B9879PX and B9879KX) included.</p> | <p>700987 Isolation logic probe</p>  <p>8 bit isolated inputs. Response time: 20 ms (AC) Suitable for high voltage measurement. Use with 758917 leads for 42 V or more. Use with 366961 leads for low level common mode voltages less than 42 V.</p> | <p>702911/702912 Logic probe (TTL/Contact input)</p>  <p>8 bit for TTL or contact closure inputs. Two measurement leads (B9879PX and B9879KX) included. Cable length: 1 m (702911), 3 m (702912)</p> |
|---|--|--|











Logic probe selection guide (for ScopeCorders)

| Model (Name) | Inputs | Input voltage range | Input impedance | Maximum input voltage | Threshold level | Note |
|--------------|--------|--|-----------------|-----------------------|-------------------------------|---|
| 700986 | 8 | ±42 V (DC + ACpeak) | Approx. 100 kΩ | ±42 V (DC + ACpeak) | 1.4 V | TTL input Response time: 1 μs or less |
| 700987 | 8 | DC: H/L detection for 10 V to 250 V (DC) AC: H/L detection for 80 V to 250 V (AC, 50/60 Hz) | Approx. 100 kΩ | 250 Vrms CAT II | DC: 6 V ±50% AC: 50 V ±50% | For power supply monitoring and isolated input Response time: DC input: 1 ms or less AC input: 20 ms or less |
| 702911 | 8 | ±35 V (DC + ACpeak) | 10 kΩ or more | ±35 V (DC + ACpeak) | Approx. 1.4 V | Cable length: 1 m TTL, contact input Response time: 3 μs or less |
| 702912 | 8 | ±35 V (DC + ACpeak) | 10 kΩ or more | ±35 V (DC + ACpeak) | Approx. 1.4 V | Cable length: 3 m TTL, contact input Response time: 3 μs or less |

High-voltage measurement accessories

These accessories enable safe, high-voltage measurements when used with the DL350, DL950, and SL1000 isolated input modules.

Note: read the User's Manual carefully before making high-voltage measurements

| | | | |
|--|--|--|---|
| <p>701901 1:1 safety BNC adapter lead</p>  <p>1000 Vrms CAT II, 1.6 m long Safety BNC (plug) to safety banana (plug). Use in combination with a pair of optional adapters or clips. 1000 Vrms CAT II</p> | <p>701904 1:1 safety adapter lead</p>  <p>Plug-in terminal (safety terminal) to safety banana (plug). Cable length: 1.5 m 1000 Vrms CAT II, 600 Vrms CAT III, 1.5 m long</p> | <p>758917 Measurement lead set</p>  <p>A set of 0.75 m long red and black test leads, stackable, used in combination with a pair of optional adapters or clips. 1000 Vrms, 32 Arms CAT II</p> | <p>758933 Measurement lead set</p>  <p>2 pieces (red and black) in 1 set Cable length: 1.0 m Used in combination with a pair of optional adapters or clips. 1000 Vrms, 19 Arms CAT III</p> |
| <p>701902/701903 Safety BNC cable</p>  <p>1000 Vrms CAT II (BNC-BNC) Cable length: 1 m (701902) 2 m (701903)</p> | <p>701906 Long test clips</p>  <p>Set contains one black and one red clip. 1000 Vrms CAT II</p> | <p>701954 Alligator clip (Dolphin type)</p>  <p>Set contains one black and one red clip. 1000 Vrms CAT II</p> | <p>758928 Pincher tip</p>  <p>Set contains one black and one red clip. 1000 Vrms CAT III</p> |
| <p>758921 Fork terminal adapter</p>  <p>Set contains one black and one red adapter. 1000 Vrms CAT II</p> | <p>758922 Small alligator-clip adapter</p>  <p>Set contains one black and one red adapter. 300 Vrms CAT II</p> | <p>758929 Large alligator-clip adapter</p>  <p>Set contains one black and one red adapter. 1000 Vrms CAT II</p> | <p>If these clips and adapters are used with differential probes such as the 700924, 701927 etc. the specifications of the maximum input voltage and frequency bandwidth may change. Caution: Take care when using the 758921 as there is a risk of electric shock from exposed metal parts.</p> |

Combination examples



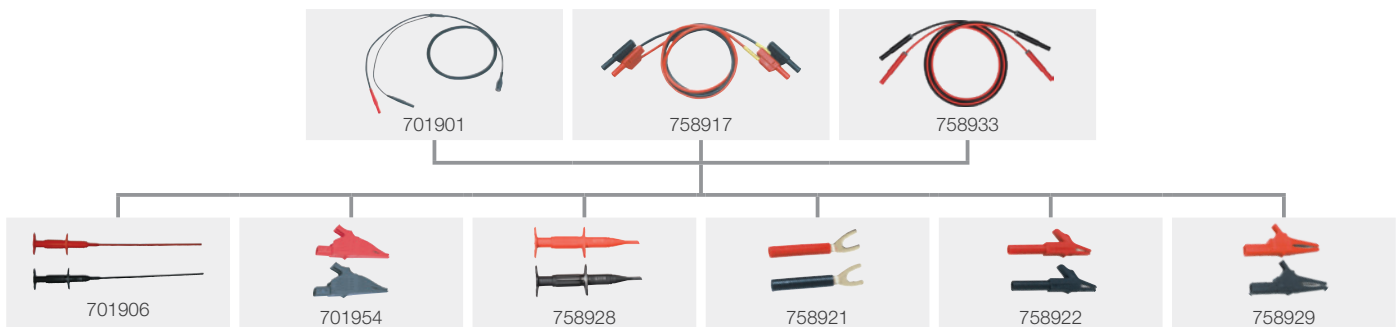



Safe measurements can be performed when using these measurement leads with appropriate clips/adapters.











The lower measurement specification is used when parts are combined.

Cables/Adapters/Other accessories



Cables and adapters

| | | | |
|--|---|---|--|
| <p>366924*1/366925*1 BNC cable</p>  <p>1 m long (366924) and 2 m long (366925) BNC-BNC cables.</p> | <p>366926*1 BNC cable (1:1)</p>  <p>1 m long BNC-alligator clip cable.</p> | <p>366961*1 Measurement lead</p>  <p>Subassembly of 1.2 m long test leads with alligator-clip adapters.</p> | <p>366973 Go/No-Go cable</p>  <p>For DLM series. Used to connect an external device.</p> |
| <p>700976 50 Ω terminator</p>  <p>Used to connect an oscilloscope having a 1 MΩ input to a probe with a 50 Ω output.*2 Frequency range: DC to 500 MHz. Allowable power: 0.5 W.</p> | <p>701982 Connection cable</p>  <p>For synchronous operation of DLMsync Cable length: 1 m (701982-01) 2.8 m (701982-02)</p> | <p>*1: Unsafe for voltage measurements above 42 V. *2: Not required for DLM oscilloscopes which can accept 50 Ω terminations directly.</p> | |

ScopeCorder accessories

| | | | |
|--|---|---|---|
| <p>720922 DC power cable</p>  <p>For DL350 Cigarette lighter plug type Cable length: approx. 2.5 m</p> | <p>720901 Synchronous connecting cable</p>  <p>For SL1000. Capable of synchronous operation for up to 8 units with a total connection cable length of 10 m or less. Cable length: 1 m (720901-01) 3 m (720901-02)</p> | <p>701955/701956 Bridge head</p>  <p>NDIS cable (5 m) included Bridge resistance: 120 Ω (701955) 350 Ω (701956)</p> | <p>701957/701958 Bridge head</p>  <p>D-sub cable (5 m) included Supports Shunt-Cal Bridge resistance: 120 Ω (701957) 350 Ω (701958)</p> |
| <p>A1002JC NDIS connector</p>  <p>NDIS connector for direct connection to a strain module.</p> | <p>720940 GPS unit</p>  <p>For DL950, SL2000 and DL350</p> | <p>720941 Optical Transceiver Module</p>  <p>For DL950 and SL2000 Multi-unit connection 1000BASE-SX SFP module 850 nm</p> | <p>720942 Optical Fiber Cord</p>  <p>For DL950 and SL2000 Multi-unit connection (LC-LC/3 m)</p> |

Others

| <p>701919 Probe stand</p>  <p>Hands-free circuit board positioner with heavy base and flexible arm. For 8 to 13 mm diameter probes.</p> | <p>701963/64/68/72 Soft carrying case</p> <table border="1"> <thead> <tr> <th>Model</th> <th>Compatible models</th> <th>Size (W) × (H) × (D) mm</th> </tr> </thead> <tbody> <tr> <td>701964</td> <td>DLM3000/3000HD</td> <td>335 × 260 × 360</td> </tr> <tr> <td>701968</td> <td>DLM4000/5000/5000HD</td> <td>520 × 285 × 285</td> </tr> <tr> <td>701972</td> <td>DL950</td> <td>450 × 260 × 275</td> </tr> </tbody> </table>  | Model | Compatible models | Size (W) × (H) × (D) mm | 701964 | DLM3000/3000HD | 335 × 260 × 360 | 701968 | DLM4000/5000/5000HD | 520 × 285 × 285 | 701972 | DL950 | 450 × 260 × 275 |
|---|---|-------------------------|-------------------|-------------------------|--------|----------------|-----------------|--------|---------------------|-----------------|--------|-------|-----------------|
| Model | Compatible models | Size (W) × (H) × (D) mm | | | | | | | | | | | |
| 701964 | DLM3000/3000HD | 335 × 260 × 360 | | | | | | | | | | | |
| 701968 | DLM4000/5000/5000HD | 520 × 285 × 285 | | | | | | | | | | | |
| 701972 | DL950 | 450 × 260 × 275 | | | | | | | | | | | |

Software

IS8000 Integrated Software Platform

Unify high precision instruments and measurement data to accelerate engineering workflow

- Combines power measurement, high-speed waveform logging, and analysis software in a single platform.
- Seamlessly completes a series of operations from data collection and analysis to report generation.

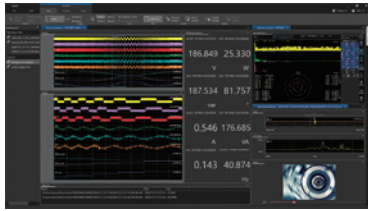

Download the free 30-day trial <<https://tmi.yokogawa.com/p/is8000/>>

| Device control | Measurement | Analysis | Export |
|------------------------|------------------------|-----------------|------------------|
| Device Settings | High-speed Acquisition | Enhanced Viewer | Export to CSV |
| Remote Monitoring | Power & Waveform Sync. | FFT Analysis | Export to MDF |
| Connect to Multi units | High-Speed Cam. Sync. | Enhanced Math | Report Generator |

IEC Harmonic/Flicker Test & Analysis IEC 61000

■ Standard functions of the software platform ■ Add-on Functions ■ Only available in IS8011/8012

Model numbers and suffix codes

Passive probe

| Model | Product | Description |
|--------|---|--|
| 701937 | Passive probe | 500 MHz bandwidth, ±600 Vpeak |
| 701938 | Passive probe | 200 MHz bandwidth, ±600 Vpeak |
| 701939 | Passive probe | 500 MHz bandwidth, ±600 Vpeak |
| 701940 | Passive probe | 10 MHz bandwidth, ±600 Vpeak |
| 701943 | Passive probe | 500 MHz bandwidth, ±600 Vpeak |
| 701946 | Miniature passive probe | 500 MHz bandwidth, 400 Vrms |
| 701949 | Miniature passive probe | 500 MHz bandwidth, 400 Vrms |
| 701944 | 100:1 high voltage probe | 400 MHz bandwidth, 1000 Vrms, cable length: 1.2 m |
| 701945 | 100:1 high voltage probe | 250 MHz bandwidth, 1000 Vrms, cable length: 3.0 m |
| 702906 | 10:1 passive probe (Wide operating temperature) | 200 MHz bandwidth, ±1000 Vpeak |
| 702907 | 10:1 passive probe (Wide operating temperature) | 200 MHz bandwidth, ±1000 Vpeak |
| 700929 | 10:1 probe | 100 MHz bandwidth, ±1000 Vpeak, for use with isolated BNC inputs |
| 701947 | 100:1 probe | 200 MHz bandwidth, ±1000 Vpeak, for use with isolated BNC inputs |
| 702902 | 10:1 passive probe (Wide operating temperature) | 60 MHz bandwidth, ±1000 Vpeak, for use with isolated BNC inputs |
| 701974 | Low capacitance probe | 5 GHz bandwidth, 500 Ω or 1 kΩ input impedance |

FET probe/Probe accessories

| Model | Product | Description |
|--------|---------------------|--|
| 700939 | FET probe | 900 MHz bandwidth, ±10 Vpeak |
| 366945 | PCB adapter | For 701937, 701938, 701939, 701943, 700939 (10 pieces) |
| 366946 | Solder-in adapter | For 701937, 701938, 701939, 701943, 700939 |
| 700971 | Mini clip converter | For 701937, 701938, 701939, 701943, 700939 |
| 700972 | BNC adapter | For 701937, 701938, 701939, 701943, 700939 |
| 701948 | Plug on clip | For 700929, 701947 |

Other software

Correspondence: Yes Incompatible: No

| Category | Software | Features/Description | Off-line waveform display and analysis | Waveform monitoring on a PC | Data transfer to a PC | Command control Custom software development |
|---------------|---------------------------|---|--|-----------------------------|-----------------------|---|
| Free Software | XWirepuller | Control the DL (M) series from the PC | No | Yes | Yes | No |
| | Control library "TMCTL" | Create programs and control the instrument remotely | No | No | No | Yes |
| | DL-Term | Command line tool for the DL series library | No | No | No | Yes |
| | LabVIEW drivers | Instrument driver *Program development environment provided by National Instruments (NI) | No | No | No | Yes |
| | MATLAB WDF Access ToolBox | Access to waveform data files saved in WDF format on MATLAB*. *MathWorks's product. | No | No | No | Yes |

Differential probe

| Model | Product | Description |
|--------|--------------------|---|
| 701977 | Differential probe | Maximum ±7000 Vpeak, 50 MHz bandwidth |
| 701978 | Differential probe | Maximum ±1500 Vpeak, 150 MHz bandwidth |
| 702923 | Differential probe | Maximum ±1000 Vpeak, 400 MHz bandwidth |
| 702924 | Differential probe | Maximum ±2000 Vpeak, 400 MHz bandwidth |
| 702928 | Differential probe | Maximum ±20 Vpeak, 200 MHz bandwidth, probe I/F |
| 701927 | Differential probe | Maximum ±1400 Vpeak, 150 MHz bandwidth, probe I/F |
| 702921 | Differential probe | Maximum ±1000 Vpeak, 400 MHz bandwidth, probe I/F |
| 702922 | Differential probe | Maximum ±2000 Vpeak, 400 MHz bandwidth, probe I/F |

Current probe

| Model | Product | Description |
|--------|---------------------------------|---|
| 701917 | Current probe | DC to 50 MHz, 5 Arms, high-sensitivity |
| 701918 | Current probe | DC to 120 MHz, 5 Arms, high-sensitivity |
| 701928 | Current probe | DC to 100 MHz, 30 Arms, probe I/F |
| 701929 | Current probe | DC to 50 MHz, 30 Arms, probe I/F |
| 701930 | Current probe | DC to 10 MHz, 150 Arms |
| 701931 | Current probe | DC to 2 MHz, 500 Arms |
| 701932 | Current probe | DC to 100 MHz, 30 Arms |
| 701933 | Current probe | DC to 50 MHz, 30 Arms |
| 701934 | Power supply | Number of connectors: 4 |
| 701936 | Deskew correction signal source | For voltage to current skew adjustment |
| 702915 | Current probe | DC to 50 MHz, 30 Arms, 3 input ranges |
| 702916 | Current probe | DC to 120 MHz, 30 Arms, 3 input ranges |

Logic probe

| Model | Product | Description |
|---------|------------------------|---------------------------------------|
| 700986 | High speed logic probe | TTL input |
| 700987 | Isolation logic probe | Isolated input |
| 701988 | Logic probe | Maximum toggle frequency: 100 MHz |
| 701989 | Logic probe | Maximum toggle frequency: 250 MHz |
| 702911 | Logic probe | TTL/contact input, cable length: 1 m |
| 702912 | Logic probe | TTL/contact input, cable length: 3 m |
| B9852ES | IC clip | For contiguous 0.5 mm pitch terminals |
| 701909 | Accessory kit | For 701989 |

High voltage measurement accessories

| Model | Product | Description |
|---|-------------------------------|---|
| 701901 | 1:1 safety BNC adapter lead | 1000 Vrms CAT II, Cable length:1.6 m |
| 701904 | 1:1 safety adapter lead | 1000 Vrms CAT II, Cable length:1.6 m |
| (701901/701904 can use with the accessories below.) | | |
| 701906 | Long test clips | 1000 Vrms CAT II, A set of black and red clip |
| 701954 | Alligator clip (Dolphin type) | 1000 Vrms CAT II, A set of black and red clip |
| 758921 | Fork terminal adapter | 1000 Vrms CAT II, A set of black and red clip |
| 758922 | Small alligator-clip adapter | 300 Vrms CAT II, A set of black and red clip |
| 758929 | Large alligator-clip adapter | 1000 Vrms CAT II, A set of black and red clip |
| 701902 | Safety BNC cable | 1000 Vrms, Cable length: 1 m |
| 701903 | Safety BNC cable | 1000 Vrms, Cable length: 2 m |
| 758917 | Measurement lead set | 1000 Vrms CAT II, A set of black and red cable |
| 758933 | Measurement lead set | 1000 Vrms CAT III, A set of black and red cable |

Cables

| Model | Product | Description |
|-----------|------------------|--|
| 366924 | BNC cable | Total length: 1 m |
| 366925 | BNC cable | Total length: 2 m |
| 366926 | BNC cable | BNC-alligator clip cable, Total length: 1 m |
| 366961 | Measurement lead | Banana-plugs (male) cable with alligator clips |
| 366973 | GO/NO-GO Cable | For DLM series |
| 701982-01 | Connection cable | For DLMsync, Cable length: 1 m |
| 701982-02 | Connection cable | For DLMsync, Cable length: 2.8 m |

Adapters

| Model | Product | Description |
|--------|-----------------|-------------------|
| 700976 | 50 Ω terminator | Feed-through type |

ScopeCorder accessories

| Model | Product | Description |
|-----------|------------------------------|--|
| 701955 | Bridge head | NDIS cable (5 m) included, 120 Ω |
| 701956 | Bridge head | NDIS cable (5 m) included, 350 Ω |
| 701957 | Bridge head | D-sub cable (5 m) included, 120 Ω |
| 701958 | Bridge head | D-sub cable (5 m) included, 350 Ω |
| A1002JC | NDIS connector | For strain module |
| 720901-01 | Synchronous connecting cable | For SL1000, Cable length: 1 m |
| 720901-02 | Synchronous connecting cable | For SL1000, Cable length: 3 m |
| 720922 | DC power cable | For DL350, cigarette lighter plug type |
| 720941 | Optical Transceiver Module | For multi-unit connection |
| 720942 | Optical Fiber Cord | For multi-unit connection, 3 m |
| 701972 | Soft carrying case | For DL950 |
| 720940 | GPS unit | For DL950, SL2000 and DL350 |

Printer Paper

| Model | Product | Description | Sales unit |
|---------|---------------|-------------------------------------|------------|
| B9988AE | Printer paper | For DLM3000/3000HD/4000/5000/5000HD | 10 |

Please order multiple of the order quantity.

| Model | Product | Description |
|--------|---------------|------------------------------|
| 701966 | Printer paper | For DL750P, SL1400 (6 rolls) |



YOKOGAWA TEST & MEASUREMENT CORPORATION
Global Sales Dept. /E-mail: tm@cs.jp.yokogawa.com

YOKOGAWA CORPORATION OF AMERICA
YOKOGAWA EUROPE B.V.
YOKOGAWA TEST & MEASUREMENT (SHANGHAI) CO., LTD.
YOKOGAWA ELECTRIC KOREA CO., LTD.
YOKOGAWA ENGINEERING ASIA PTE. LTD.
YOKOGAWA INDIA LTD.
YOKOGAWA ELECTRIC CIS LTD.
YOKOGAWA AMERICA DO SUL LTDA.
YOKOGAWA MIDDLE EAST & AFRICA B.S.C(c)

<https://tmi.yokogawa.com/us/>
<https://tmi.yokogawa.com/eu/>
<https://tmi.yokogawa.com/cn/>
<https://tmi.yokogawa.com/kr/>
<https://tmi.yokogawa.com/sg/>
<https://tmi.yokogawa.com/in/>
<https://tmi.yokogawa.com/ru/>
<https://tmi.yokogawa.com/br/>
<https://tmi.yokogawa.com/bh/>

Others

| Model | Product | Description |
|--------|-------------|---|
| 701919 | Probe stand | Attachable probe: approx. dia. 8 to 13 mm |

Carrying Cases

| Model | Product | Description |
|--------|--------------------|-------------------------|
| 701964 | Soft carrying case | For DLM3000/3000HD |
| 701968 | Soft carrying case | For DLM4000/5000/5000HD |
| 701972 | Soft carrying case | For DL950 |
| 93050 | Carrying case | For DL350 |

Rack mount kit

| Model | Product | Description |
|-----------|-------------------|-------------------------------|
| 701969-E | Rack mount kit | For DLM4000/5000/5000HD (EIA) |
| 751541-E4 | Rack mount kit | For SL1000 (EIA) |
| 751542-E4 | Rack mounting kit | For SL2000 (EIA) |

Front Panel Protective Covers

| Model | Product | Description |
|---------|------------------------------|--------------------|
| B8219EP | Front cover | For DLM3000/3000HD |
| B8069CH | Front cover | For DLM4000 |
| B8217CB | Front panel protective cover | For DL950 |
| B8229CH | Front panel protective cover | For DLM5000/5000HD |

Software

| Product | Model | Suffix code | Description |
|-------------------------------------|-----------------|-------------|---|
| IS8000 Integrated Software Platform | IS8001*1 | | IS8000 Integrated Software Platform Subscription (Annual license) |
| | | | IS8000 Integrated Software Platform Perpetual (Permanent license) |
| Classic Data Viewer | IS8002 CDV*1 | -P01 | Perpetual (Permanent license) |
| XWirepuller | (Free software) | | Waveform monitoring and instrument control |

*1: See Bulletin IS8000-01EN for more detail about IS8000.

Visit the following web sites for details about this software:
<<http://tmi.yokogawa.com/products/oscilloscopes/oscilloscopes-application-software/>>

Any company's names and product names mentioned in this document are trade names, trademarks or registered trademarks of their respective companies.

NOTICE

- Before operating the product, read the user's manual thoroughly for proper and safe operation.

<https://tmi.yokogawa.com/>

YMI-N-MI-M-E03

The contents are as of November 2025. Subject to change without notice.
Copyright © 2022, Yokogawa Test & Measurement Corporation
[Ed: 04/b] Printed in Japan, 511(KP)