



Advanced Test Equipment Corp.

www.atecorp.com 800-404-ATEC (2832)



WINDOW FOR THE NANO WORLD

SCANNING ELECTRON MICROSCOPES

TABLE-TOP SEM : EM SERIES

EM-30N

New & Notable

EM-30N, which is a product of COXEM's steady investment for technology and development with a view to the era of nano-mechatronics, can deliver clear images without noise even at high magnification and scan an even wider area with its panorama feature.

Also, its full compatibility with EDS delivers optimized performance.

Satisfactory both in performance and price, EM-30N will shine in all research areas and deliver superb results to the development and utilization of advanced technology.



Effect of High Resolution

EM-30N boasts the advantage that it enables high magnification observation of images. Moreover, it can effectively get high-resolution images by adjusting the voltage, operational distance, and electronic beam size.

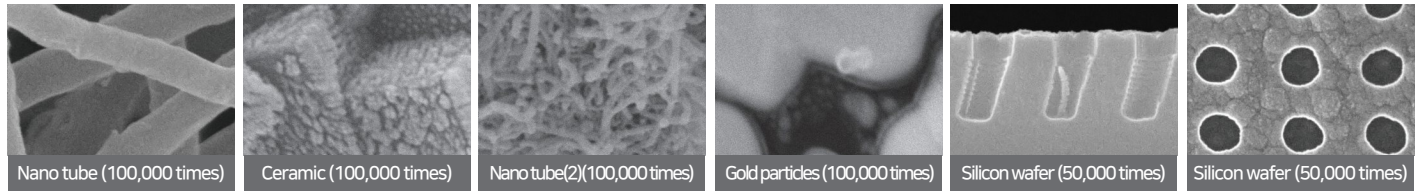

Dual Display / Signal Mixing Mode

Dual Display Mode

The dual display mode delivers SE and BSE images in a single-view presentation.

Signal Mixing Mode

Combining SE and BSE images provides a single-view access to the forms and chemical composition of samples.

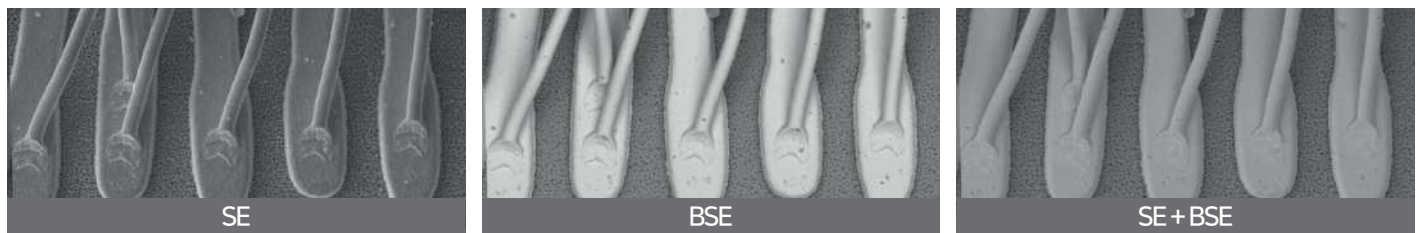

Duplex Navi

The NanoStation interface provides multiple means of navigation simply by clicking within any of the 3 different magnified views:

- ① A micro view using the CCD Navi Cam or Sample Holder map to move from sample to sample or areas of a large sample.
- ② A micro view using the low magnification MiniMap image with a Field of View (FOV) indicator to move within a sample
- ③ A nano view at the desired FOV allows movement by clicking in the image or using the Image Shift controls to make nanometer movements for perfect centering and alignment of sample features of interest

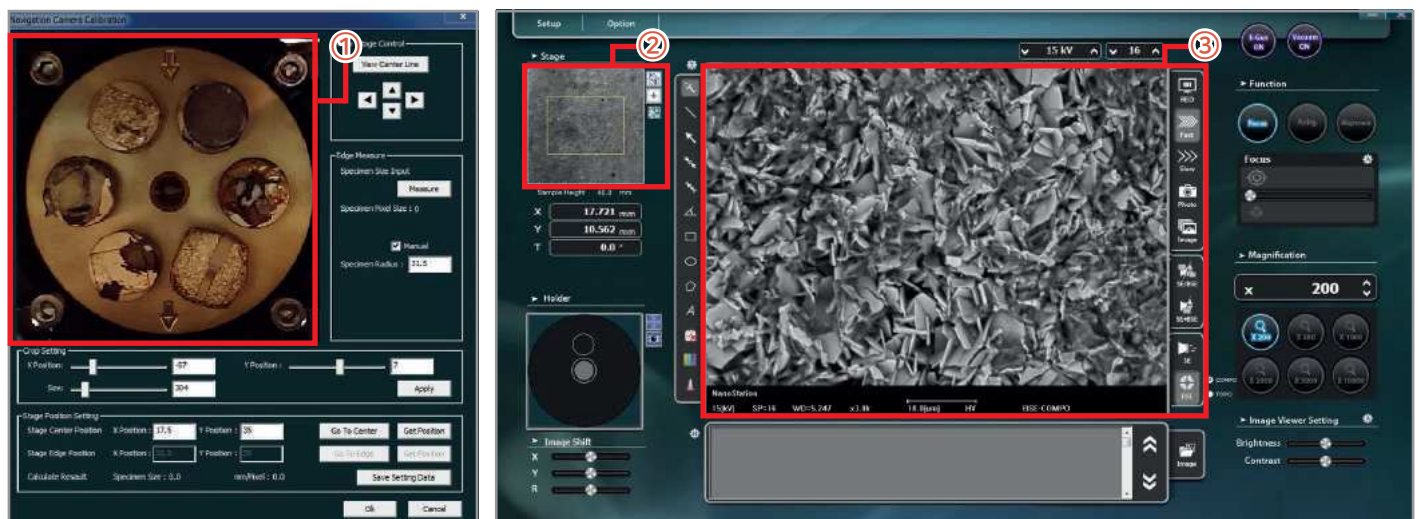

Particle Analysis

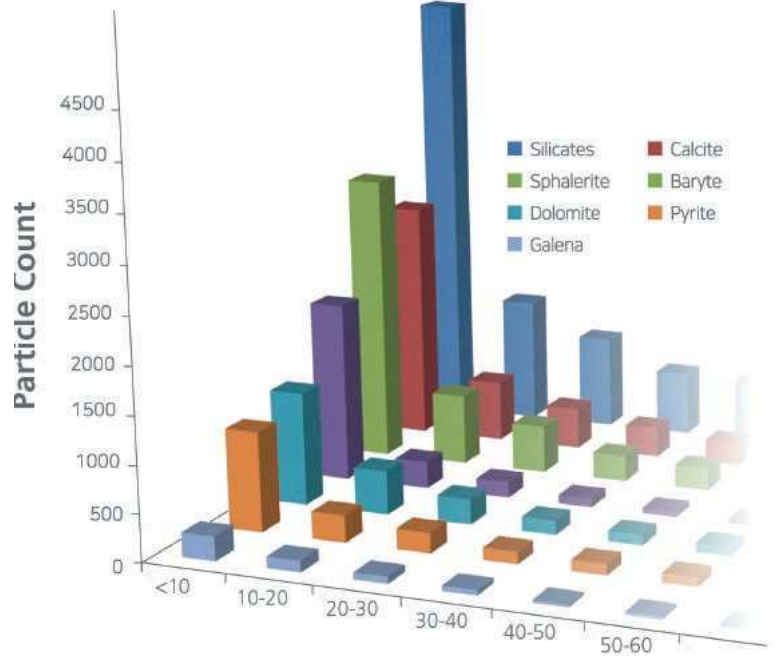
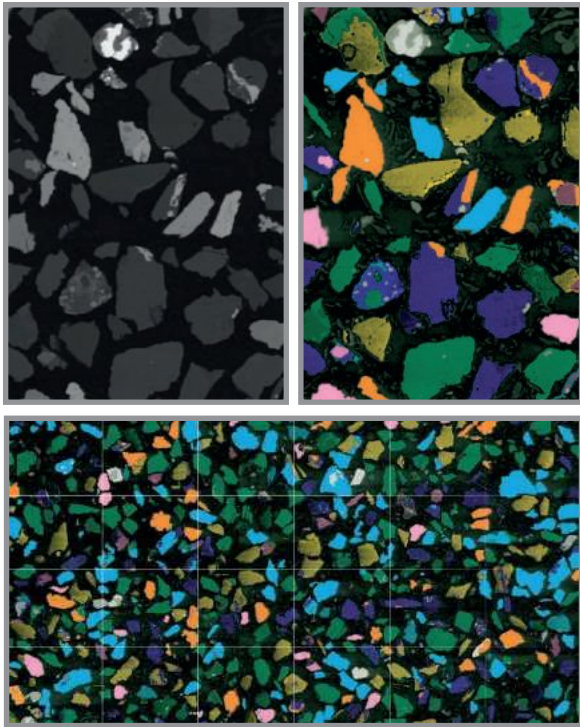

Particle analysis can be done with various methods, and accurate analysis is ensured even for composite samples.

STEM Analysis

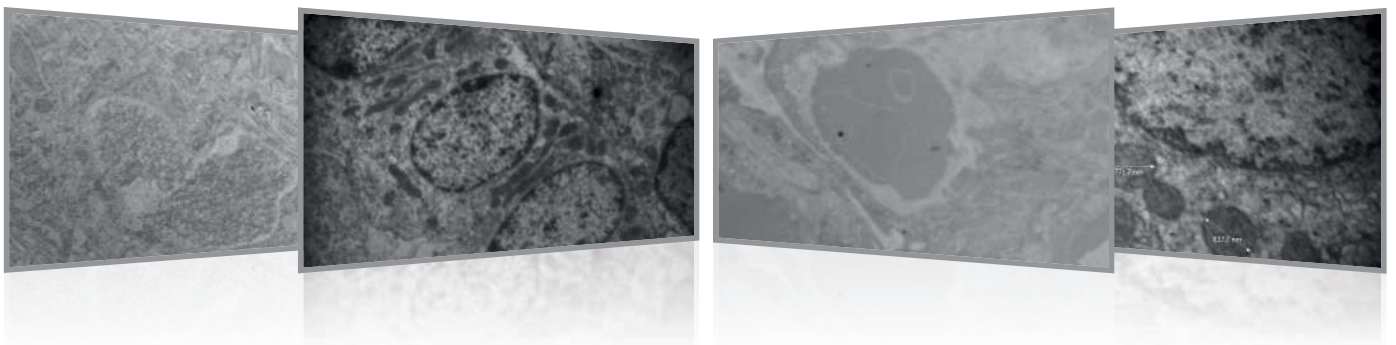

Coxem offers a true, retractable STEM detector enabling the EM-30N to perform TEM analysis of samples on standard TEM grids using our higher kV capability than other Tabletop SEM models. Imaging in both Bright and Dark field is possible as well as using EDS on up to 4 samples mounted simultaneously.

Coolstage

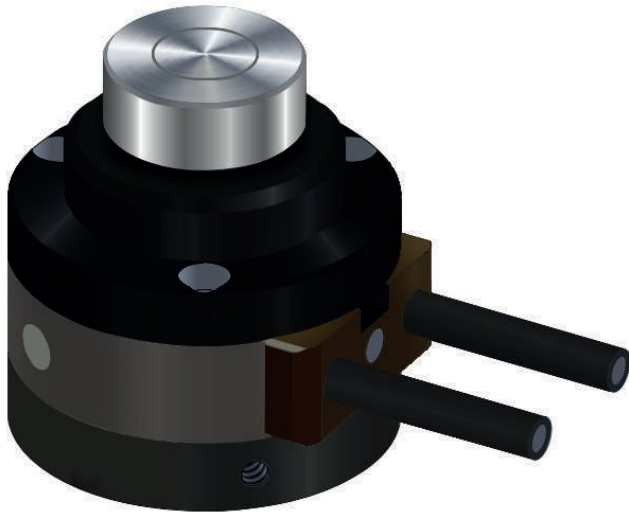

Performing SEM observations of moist samples requires a variety of pretreatments such as critical point drying and fixation. To shorten such complex sample preparation procedures, the COXEM Coolstage lowers the temperature of the sample to freeze internal moisture preventing the damaging effects of vacuum on delicate microstructure.

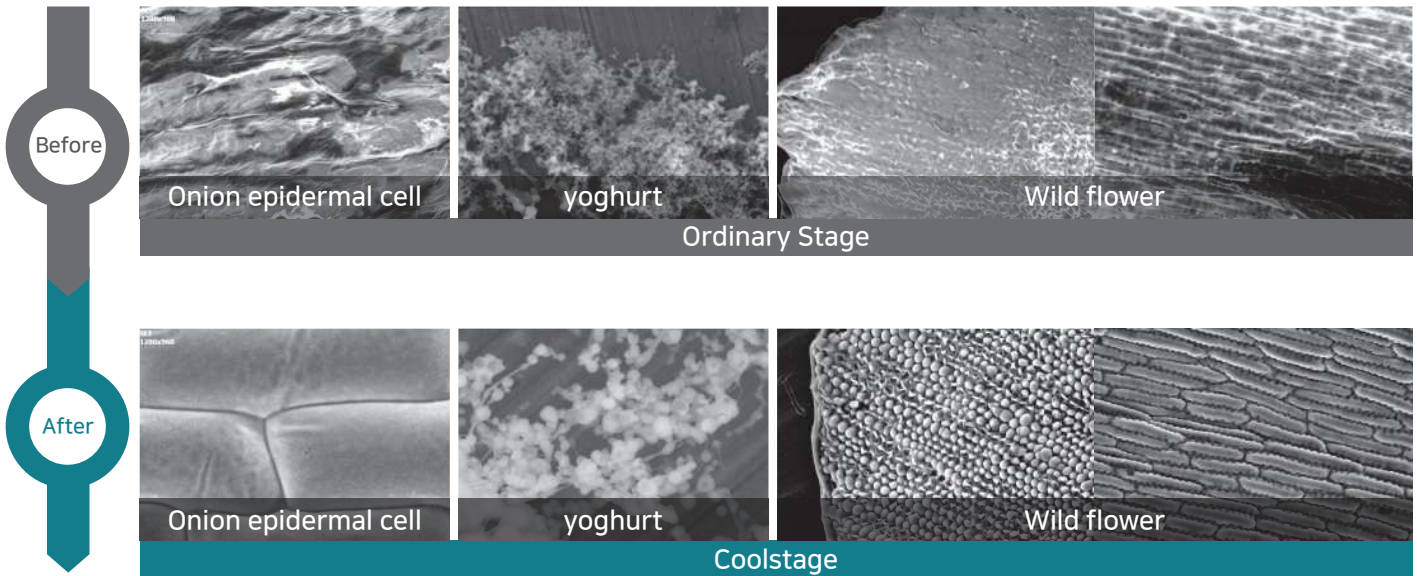

Control Temperature Range	-25°C~ 50°C
Temperature Precision	±0.1°C
Temperature Accuracy	±0.1°C
Sample Holder Size	18mm(d)

EM Series

Model	EM-30P	EM-30N
Resolution	5nm	5nm
Magnification	Up to 150,000 X	Up to 150,000 X
Standard	SED	SED
	BSED	BSED(DP)
		Navi Cam
		LV
		Diaphragm Pump
Optional	Navi Cam	STEM
	LV	Coolstage
	Diaphragm Pump	EDS(MPO)
	Coolstage	EDS(MPO+Feature)
	EDS(MPO)	Panorama Ver 2.0

Items	EM-30P	EM-30N
SED	v	v
BSED	v	
BSED(DP)		v
NaviCam	o	v
LV	o	v
Panorama Ver 1.0	v	v
Panorama Ver 2.0		o
Diaphragm Pump	o	v
STEM		o
Coolstage	o	o
EDS(MPO)	o	o
EDS(MPO+Feature)	o	o

* v : standard

* o : option

Low Vacuum Mode

Using the low vacuum (LV) mode, one can easily get an image of non-conductive samples or insulating materials without involving any special pretreatment.

High Vacuum

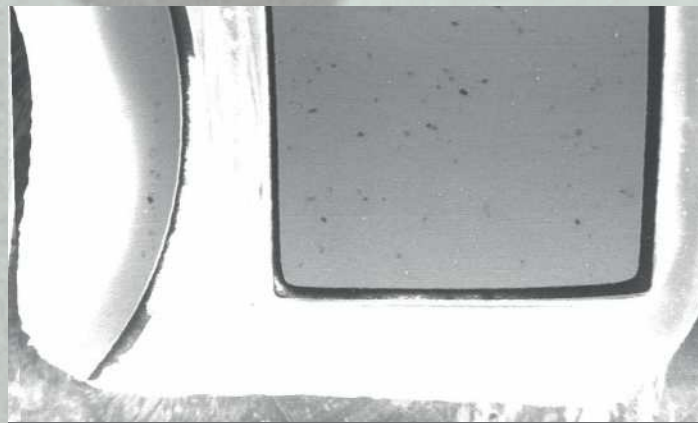

Low Vacuum



Semiconductor



Semiconductor

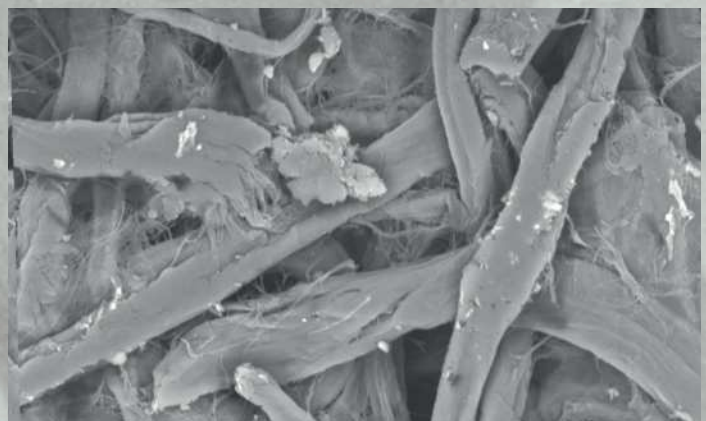

Paper

Dual Image / Signal Mixing Mode

Electron microscope can realize images by collecting the different signals generated from samples with electronic beam.

The SE detector can get data as created by ruggedness by capturing secondary electrons (SE), and the backscattered electrons (BSE) collected with the BSE detector can get the elementary composition and stereoscopic images of the samples. It also performs signal merging, which presents the images of the forms and shapes of samples on a single screen.

Metals

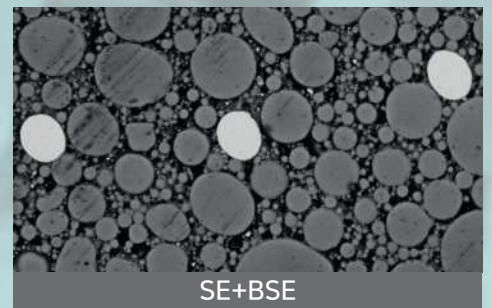
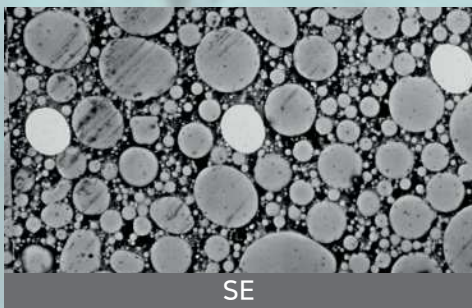

Semiconductor

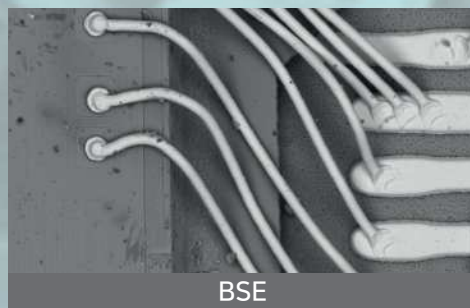

Minerals

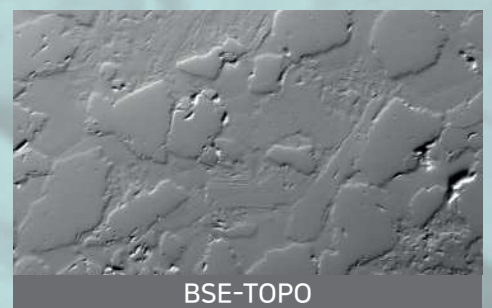
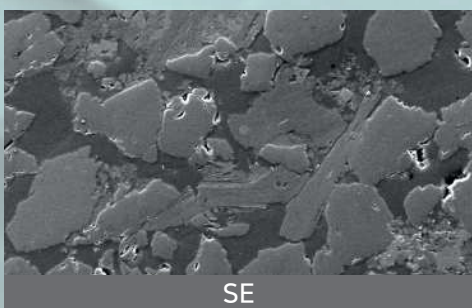

Minerals

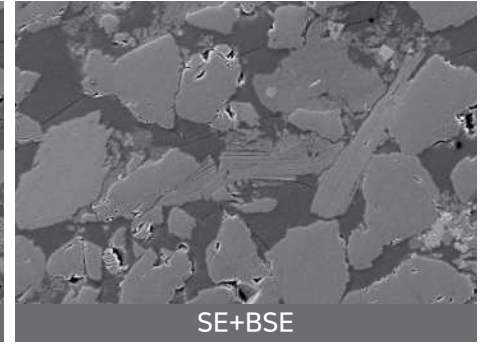
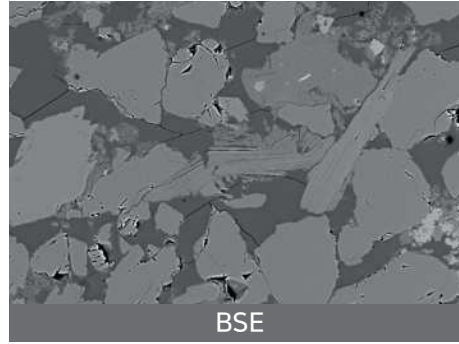
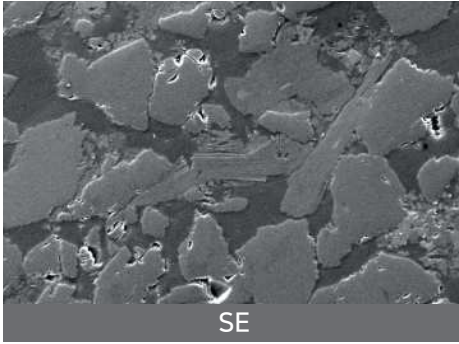

Rice

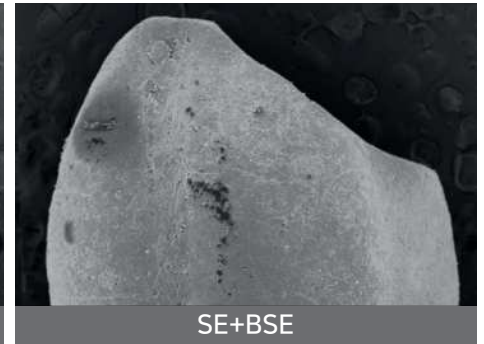
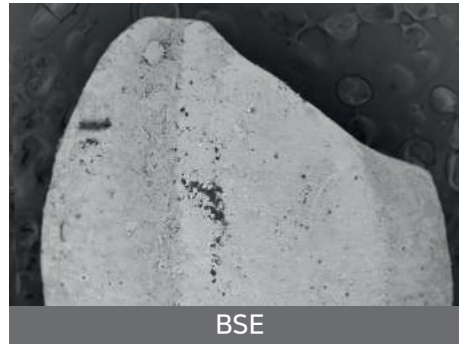

Rocks

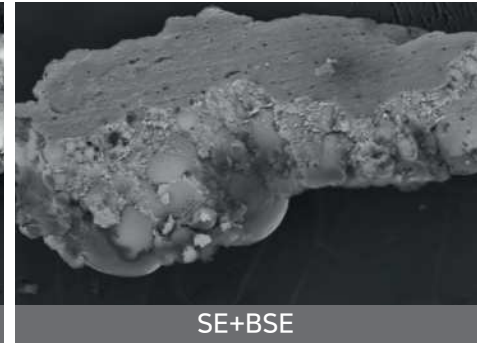
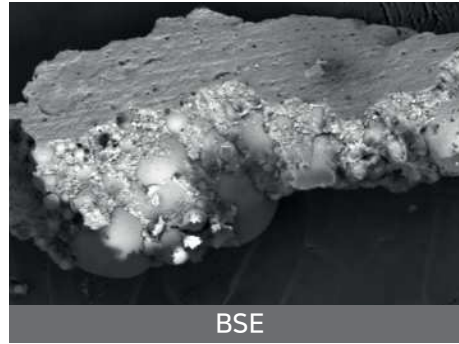
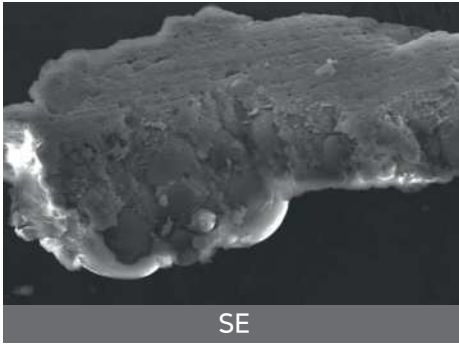

Tree bark

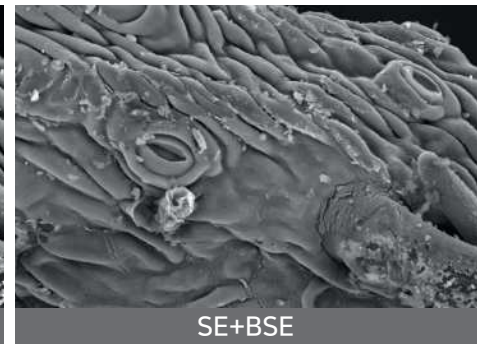
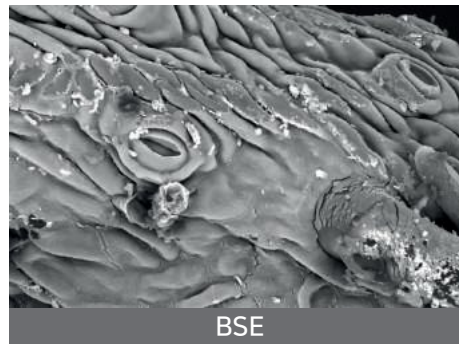
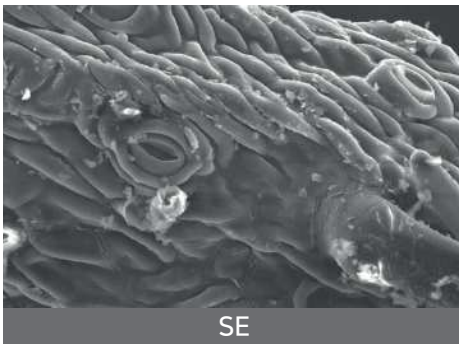

Nano Station

Panorama Shot

The panorama feature gets an image covering a very large scope at high magnification.

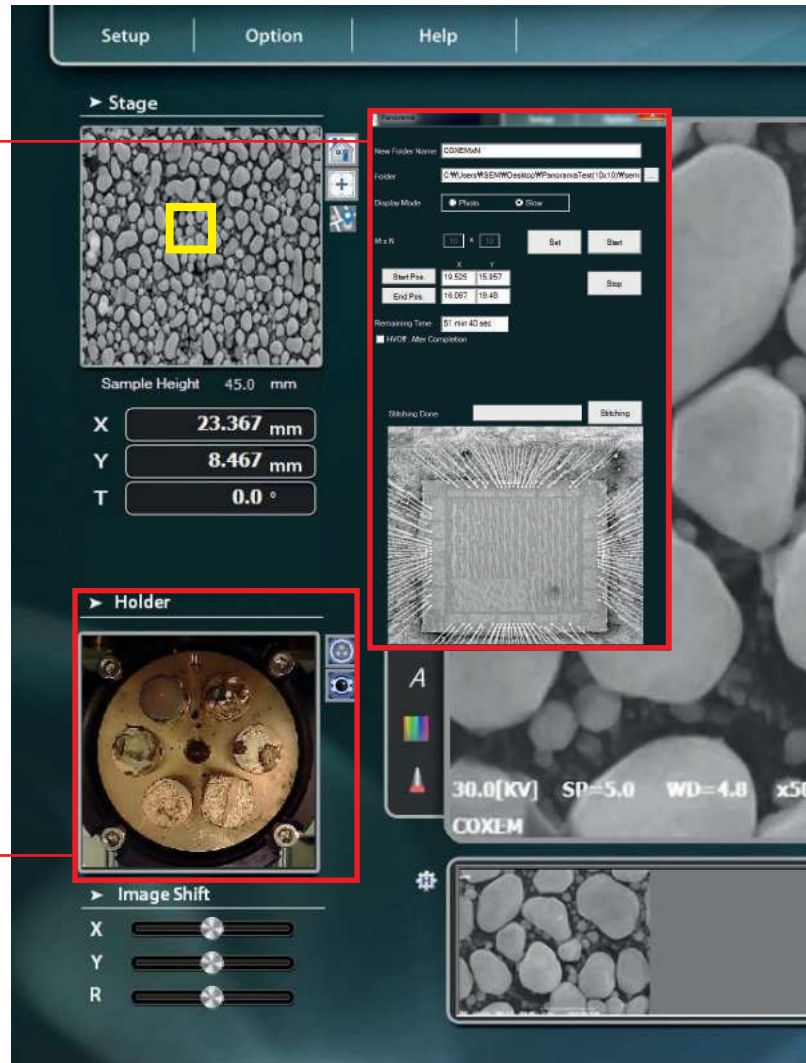
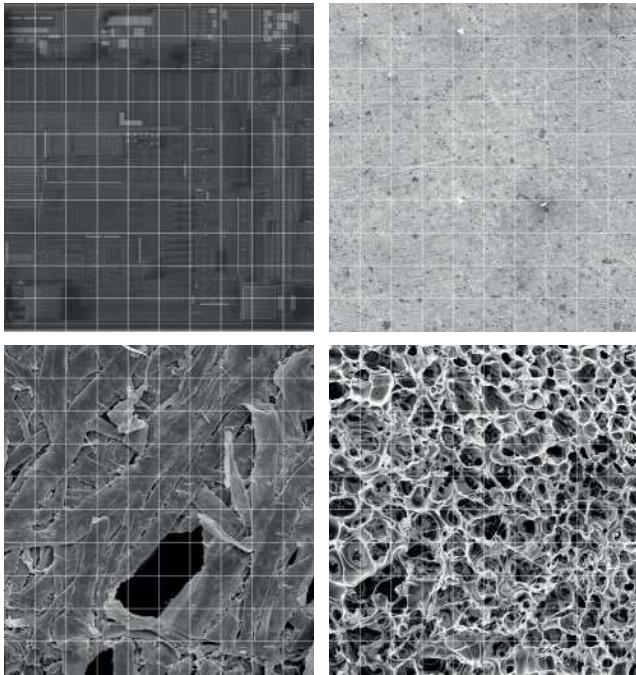

Multi-Sample holder

The SEM sample holder, which is available in various kinds, ensures easy, quick, and accurate measurement that adapts to sample location.

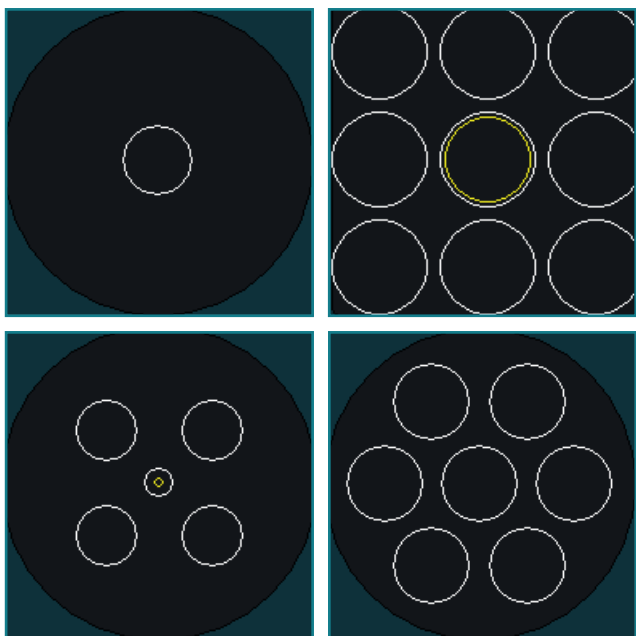

Navigation Camera

The built-in optical camera serves to locate actual samples and can move to desired locations.

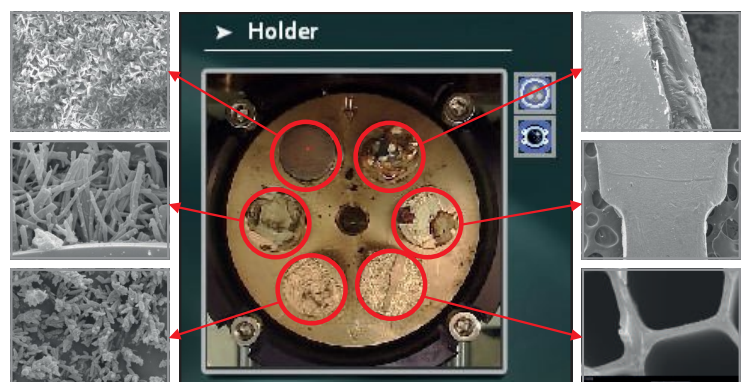



Auto Brightness Contrast

The user can get an optimized image in 1 second.

Line Profile tool

The line-profiling technique provides more detailed data as the size and size can be measured more closely with nanoscale steps.



Buyer's Guide

STEP
01

Which SEM is the best for you?

1. COXEM's SEM, which can freely adjust acceleration voltage between 1kV and 30kV, can analyze images in a way that fits the characteristics of a sample.

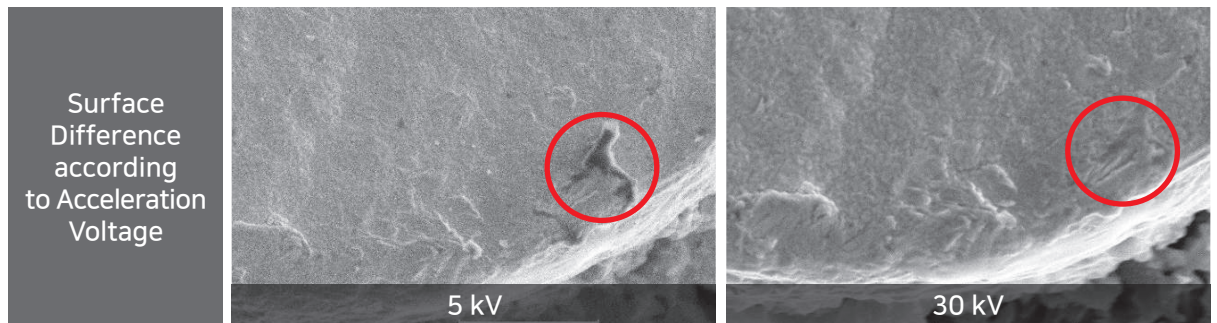

2. COXEM's SEM can perform analysis at varying magnification ranging from low to high. 20x to 150,000x

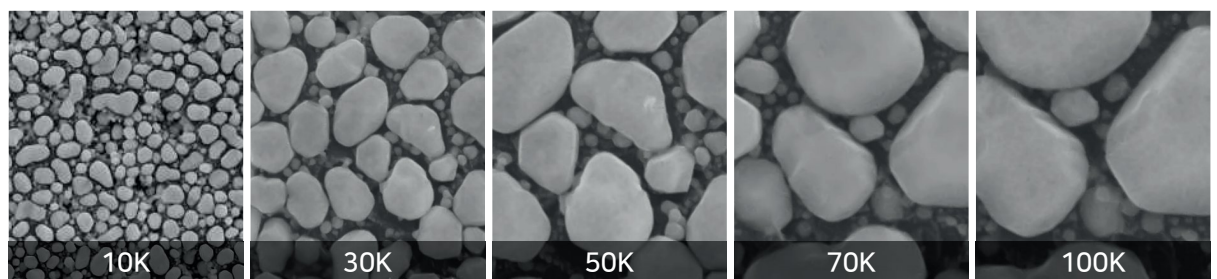

3. COXEM's SEM, which inserts the STEM detector, can perform the TEM analysis with its sensor, thus able to analyze asbestos, cell tissue, and nano-structures among others.

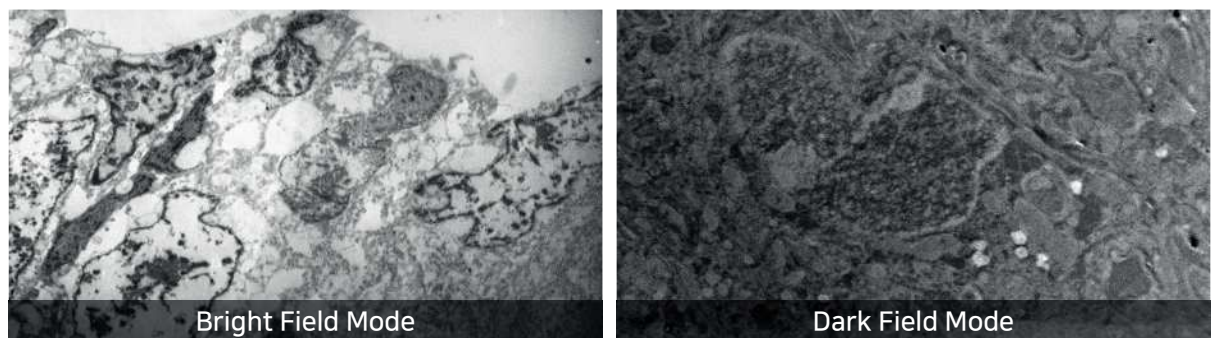

4. COXEM's SEM can include EDS in addition and analyze various particles including features, GSR, and steel.



5. COXEM's SEM, which uses Coolstage, can analyze live specimens (such as fungi, cells, and insects) by freezing them and get images of microstructures free from damage.

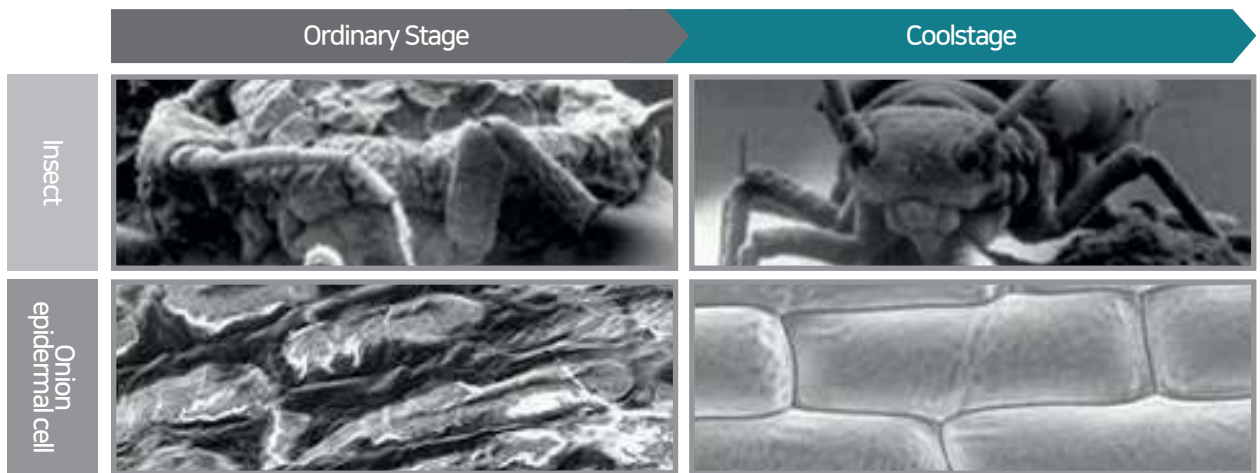

6. COXEM's SEM is convenient and easy to install.
Simply connect power, USB and the provided vacuum pump.



* Our local Distributors provide Installation and Training Service if desired

How best can I buy the product?

1. If you have any sample to analyze, send it to COXEM.
As our Demonstration Room has pretreatment equipment including sputter, polisher, and cool stage, we can analyze various kinds of specimens.
2. Based on the analysis data, we compare, analyze and evaluate the resulting values as measured against the customer's expectations.
3. Check the analysis parameters desired about the sample and seek consultation.
Options may be added according to purposes (such as SE, BSE, and EDS).
4. Select, buy, and get training for the equipment suitable for the sample analysis.
Training is provided on how to effectively use the equipment with a view to its installation.
5. In case a customer needs additional training, please consult your local distributor.



STEP
02

Buyer's Guide

STEP 03

If you need services as a user of SEM, please call us.

1. Reach us through our website or call your local distributor.
To find your local distributor, please visit our website at www.coxem.com
2. Problems can be identified and usually corrected via remote control access by our service team or distributors.
3. On-site support and repairs are available through your local distributor.



COXEM and its network of Sales Agents around the world are available to assist you with local sales, support, training and **equipment evaluation**.



■ KOREA : Daejeon

■ International Offices :

- China - Beijing, Shanghai, Ansan
- USA - Portland
- United Kingdom - London

- Germany - Mannheim
- Spain - Madrid
- Italy - Milano
- France - Paris

- Russia - Moscow
- Thailand - Bangkok
- Australia - Perth

Installation

Specification

	EM-30N	EM-30AXN
Magnification	20-150,000X	
Spatial Resolution	<5nm	
Vacuum Mode	HV/LV (Standard)	
Acceleration Voltage	1 - 30kV (adjustable in 1kV scale)	
Electron Source	Pre-Centered Tungsten Filament	
Detector	SED(DP)	
	BSED(DP)	
	EDS Option	EDS standard (30mm Compact Type EDS)
Sample Size	70mm (W) x 45mm (H)	
X-Y/T Traverse	35x35mm / 0 - 45°	
Features	Panorama 1.0	
	Auto Focus	
	1 second Auto Brightness / Contrast	
	Auto Filament	
	Auto Start	
	Duplex Navi	
	Signal Mix	
	Dual Display & Save	
	Line Profile	
	Image Filtering	
	Line Measurement	
	Color Measurement	
Automation	Focus, Filament, Brightness/Contrast	
Data Output Format	JPEG, TIFF, BMP	
Dimensions	400 x 600 x 550 mm	
Weight	85 kg	95 kg
OPTIONS	STEM	
	CoolStage	
	Panorama 2.0	
	30mm Active Size Compact Type EDS (Particle Analysis)	
	30mm Active Size Compact Type EDS (MPO included)	

Installation Condition *

Power	110V/ 220V, 50/60Hz, Ground 3V, Capacity 1kVA
Vibration	Less than 35dB
Magnetic Field	Less than 0.50mG
Sound Noise	Less than 60dB
Temperature	20°C ±5°C
Humidity	Less than 70%

* In order to reach maximum performance specifications

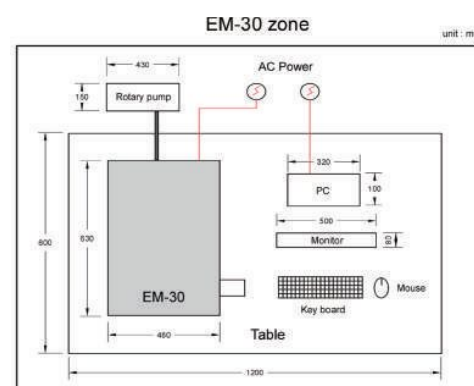



#201, Migun Technoworld, 199 Techno2-ro,
Yuseong-gu, Daejeon, Korea, 34025
Tel_+82-42-861-1686 Fax_+82-42-861-1689
Email_overseas@coxem.com

www.coxem.com
www.coxem-app.com