



Advanced Test Equipment Corp.

www.atecorp.com 800-404-ATEC (2832)



**SATURN THERMOCOUPLE
CALIBRATION FACILITY
MODEL 877**





User Maintenance Manual/Handbook

Isothermal Technology Limited, Pine Grove, Southport, PR9 9AG, England

Tel: +44 (0)1704 543830 Fax: +44 (0)1704 544799 Internet: www.isotech.co.uk E-mail: info@isotech.co.uk

The company is always willing to give technical advice and assistance where appropriate. Equally, because of the programme of continual development and improvement we reserve the right to amend or alter characteristics and design without prior notice. This publication is for information only

CONTENTS

CONTENTS	2
GUARANTEE.....	3
CAUTIONARY NOTE.....	4
 EMC INFORMATION.....	5
 ELECTRICAL SAFETY	5
Environmental Ratings.....	5
 HEALTH AND SAFETY INSTRUCTIONS	6
 IMPORTANT SATURN 'SPIDER' UNPACKING NOTE	7
INTRODUCTION	8
THEORY OF OPERATION	9
SATURN HIGH TEMPERATURE CALIBRATION FURNACE 100°C TO 1300°C	10
INTRODUCTION	10
FEATURES	10
HORIZONTAL CROSS SECTION THROUGH THE SATURN	11
PRINCIPLE OF OPERATION.....	11
NOMINAL DIMENSIONS.....	12
SPECIAL FEATURES.....	14
EACH UNIT COMPRISES	15
PRECAUTIONS	16
 CAUTION	17
ON ARRIVAL	18
COMMISSIONING	19
SAMPLE RESULTS	19
USING THE CONTROLLER.....	20
FRONT PANEL LAYOUT	20
The Temperature Controller.....	20
Altering the Setpoint	20
ADVANCED CONTROLLER FEATURES.....	20
Setpoint Ramp Rate.....	20
Instrument Address.....	21
Monitoring the Controller Status	21
Units.....	21
DIAGNOSTIC ALARMS.....	22
USING THE PC INTERFACE	23
CONNECTIONS.....	23
CAL NOTEPAD.....	24
DEVELOPMENT	24
HOW TO INSTALL CAL NOTEPAD	25
PROTOCOL	25
GETTING THE BEST FROM YOUR SATURN	26
INTRODUCTION	26
SATURN MODEL 877 PERFORMANCE REPORT - APPENDIX I.....	27

GUARANTEE

This instrument has been manufactured to exacting standards and is guaranteed for twelve months against electrical break-down or mechanical failure caused through defective material or workmanship, provided the failure is not the result of misuse. In the event of failure covered by this guarantee, the instrument must be returned, carriage paid, to the supplier for examination and will be replaced or repaired at our option.

FRAGILE CERAMIC AND/OR GLASS PARTS ARE NOT COVERED BY THIS GUARANTEE

INTERFERENCE WITH OR FAILURE TO PROPERLY MAINTAIN THIS INSTRUMENT MAY INVALIDATE THIS GUARANTEE

RECOMMENDATION

The life of your **ISOTECH** Instrument will be prolonged if regular maintenance and cleaning to remove general dust and debris is carried out.

ISOTHERMAL TECHNOLOGY LTD.
PINE GROVE, SOUTHPORT
PR9 9AG, ENGLAND

TEL: +44 (0) 1704 543830/544611

FAX: +44 (0) 1704) 544799

The company is always willing to give technical advice and assistance where appropriate. Equally, because of the programme of continual development and improvement we reserve the right to amend or alter characteristics and design without prior notice. This publication is for information only.

**CAUTIONARY NOTE**



ISOTECH PRODUCTS ARE INTENDED FOR USE BY TECHNICALLY TRAINED AND COMPETENT PERSONNEL FAMILIAR WITH GOOD MEASUREMENT PRACTICES.

IT IS EXPECTED THAT PERSONNEL USING THIS EQUIPMENT WILL BE COMPETENT WITH THE MANAGEMENT OF APPARATUS WHICH MAY BE POWERED OR UNDER EXTREMES OF TEMPERATURE, AND ARE ABLE TO APPRECIATE THE HAZARDS WHICH MAY BE ASSOCIATED WITH, AND THE PRECAUTIONS TO BE TAKEN WITH, SUCH EQUIPMENT.

CE EMC INFORMATION

This product meets the requirements of the European Directive on Electromagnetic Compatibility (EMC) 89/336/EEC as amended by EC Directive 92/31/EEC and the European Low Voltage Directive 73/25/EEC, amended by 93/68/EEC. To ensure emission compliance please ensure that any serial communications connecting leads are fully screened.

The product meets the susceptibility requirements of EN 50082-1, criterion B.

Symbol Identification	Publication	Description
	ISO3864	Caution (refer to manual)
	IEC 417	Caution, Hot Surface

ELECTRICAL SAFETY

This equipment must be correctly earthed.

This equipment is a Class I Appliance. A protective earth is used to ensure the conductive parts cannot become live in the event of a failure of the insulation.

The protective conductor of the flexible mains cable which is coloured green/yellow **MUST** be connected to a suitable earth.

The blue conductor should be connected to Neutral and the Brown conductor to Live (Line).

Warning: Internal mains voltage hazard. Do not remove the panels.

There are no user serviceable parts inside. Contact your nearest Isotech agent for repair.

Voltage transients on the supply must not exceed 2.5kV.

Conductive pollution, e.g. Carbon dust, must be excluded from the apparatus. EN61010 pollution degree 2.

Environmental Ratings

Operating Temperature 0-50°C

Relative Humidity 5-95%, non condensing

HEALTH AND SAFETY INSTRUCTIONS

1. Read this entire manual before use.
2. Wear appropriate protective clothing.
3. Operators of this equipment should be adequately trained in the handling of hot and cold items and liquids.
4. Do not use the apparatus for jobs other than those for which it was designed, i.e. the calibration of thermometers.
5. Do not handle the apparatus when it is hot (or cold), unless wearing the appropriate protective clothing and having the necessary training.
6. Do not drill, modify or otherwise change the shape of the apparatus.
7. Do not dismantle the apparatus.
8. Do not use the apparatus outside its recommended temperature range.
9. If cased, do not return the apparatus to its carrying case until the unit has cooled.
10. There are no user serviceable parts inside. Contact your nearest Isotech agent for repair.
11. Ensure materials, especially flammable materials are kept away from hot parts of the apparatus, to prevent fire risk.

IMPORTANT SATURN 'SPIDER' UNPACKING NOTE

1. Cut open top of the outer box.
2. Remove the polystyrene and shredded material.
3. Carefully remove the inner case and stand it on its four screwed studding's.
4. Carefully unscrew bolts and remove chipboard and Polystyrene Square, exposing ceramic spider.

INTRODUCTION

This furnace has been uniquely designed for the accurate calibration of a number of thermocouples over a very wide temperature range.

Introduced by Isothermal Technology in 1984, the full potential of the bath has yet to be realized. However, with proper care, a thermocouple may be calibrated from 100°C up to 1250°C in as many steps as required.

A variety of special designs are available to customer's requirements.

Special attention has been given in the design to the geometric layout of the sensors to enable up to 15 thermocouples, including their head assemblies to be housed and calibrated at the same time.

THEORY OF OPERATION

The major problem of calibration furnace systems has been what is called "end effects".

This is the problem encountered in any tubular furnace due to the fact that the ends of the tube tend to be cooler than the central part of the tube.

To compensate for this, windings that heat the tube are specially profiled to give a uniform area of constant temperature in the central part of the tubular oven or furnace.

To further even out the temperature gradients, metal or ceramic equalising blocks are introduced.

With enough effort this fundamentally unsound device can be made to give fairly good results.

The theory behind the Isotech Saturn Furnace is that a solid conducting sphere suspended in the centre of a hollow outer, heated sphere will take up the temperature of the outer hollow heated sphere by convection and radiation to give a very stable temperature reference without end or edge effects.

The second step in the design of the sphere was the assumption that the point at the centre of the inner solid sphere would be not only at a stable temperature, but would be virtually unaffected by short term fluctuations in the temperature of the outer hollow heated sphere.

In practice, the above assumptions have proved correct and after considerable development have enabled a practical realisation of the theory to become available.

A number, up to 16, of close ended pockets have been introduced into the central sphere along a circumference. These pockets meet the very centre of the inner sphere, thus tapping the source of uniform unfluctuating temperature.

The larger the number of pockets and the larger each pocket becomes the further from the centre of the inner sphere are the ends of the pockets.

To compensate for this the central sphere is made larger so that there is a slower response to temperature changes and a longer time to stabilise.

Unlike its competitors, the Saturn Furnace rewards the patience of its user. The longer the furnace is left, the more any temperature gradients inside the inner sphere even out.

SATURN HIGH TEMPERATURE CALIBRATION FURNACE 100°C TO 1300°C

INTRODUCTION

The Isotech Saturn Furnace has been designed for the accurate calibration of thermocouples over the temperature range 100°C to 1300°C.

Most high temperature calibration furnaces are no more than specially profiled muffle or tube furnaces in which thermocouples are placed in parallel tubes. These designs suffer from a number of problems, the major ones being poor temperature stability and limited access, (usually only 3 or 4 thermocouples can be calibrated at one time).

Isotech's calibration furnace is revolutionary from a number of aspects:-

FEATURES

1. It is spherical and its design ensures a central zone of constant temperature.
2. Thermocouples are inserted around the circumference of the furnaces and when fully inserted, the measuring junctions are within a few millimetres of each other and of the centre of the sphere.
3. 7 to 15 thermocouples can be calibrated simultaneously.
4. The accuracy ($\pm 0.25^\circ\text{C}$ in 1000°C) of the furnace has only previously been achieved by using heat pipes.
5. Because of the design, the price is only half to one third of a bath with comparable accuracy and much smaller capacity for calibration.
6. The temperature of the furnace is controlled from a microprocessor based controller which can incorporate remote facilities, enabling the furnace temperatures to be pre-programmed from a computer. Thus, totally automatic calibration becomes possible and easily realizable.
7. The use of newly developed modern ceramic materials has enabled high accuracy, low mass and high stability to be obtained.
8. Each thermocouple is completely isolated in a gas tight closed end tube to prevent any contamination problems during calibration.
9. Normally the windings will require replacing after 2 or 4 years of operating (dependant on work cycle) and so the furnace has been designed with ease of maintenance in mind. A spare set of windings is provided free with each furnace, as is a comprehensive manual.

HORIZONTAL CROSS SECTION THROUGH THE SATURN

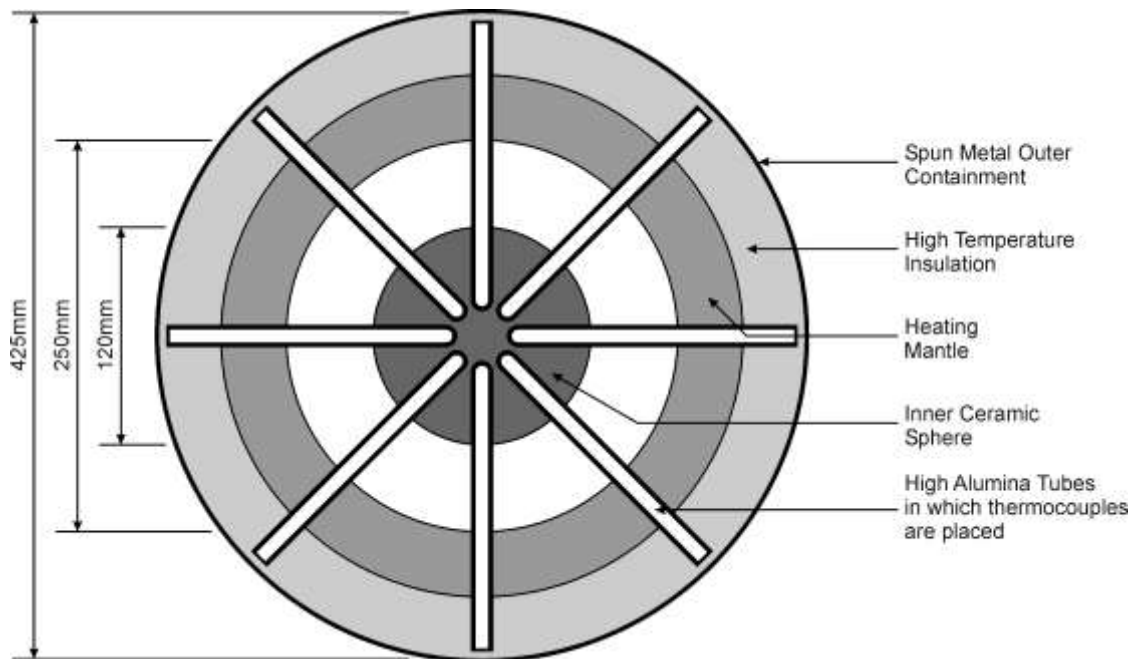

PRINCIPLE OF OPERATION

The Saturn comprises of a number of concentric shells. The outer layer of spun metal is for containment and support, inside this is a layer of ceramic fibre. Within the fibre is a ceramic spherical mantle containing the heater windings.

Lastly, in the centre of the furnace is a solid ceramic sphere cast with 8 or 16 tubes* to be used for the thermocouples requiring calibration.

*Depending on design requirements.

NOMINAL DIMENSIONS

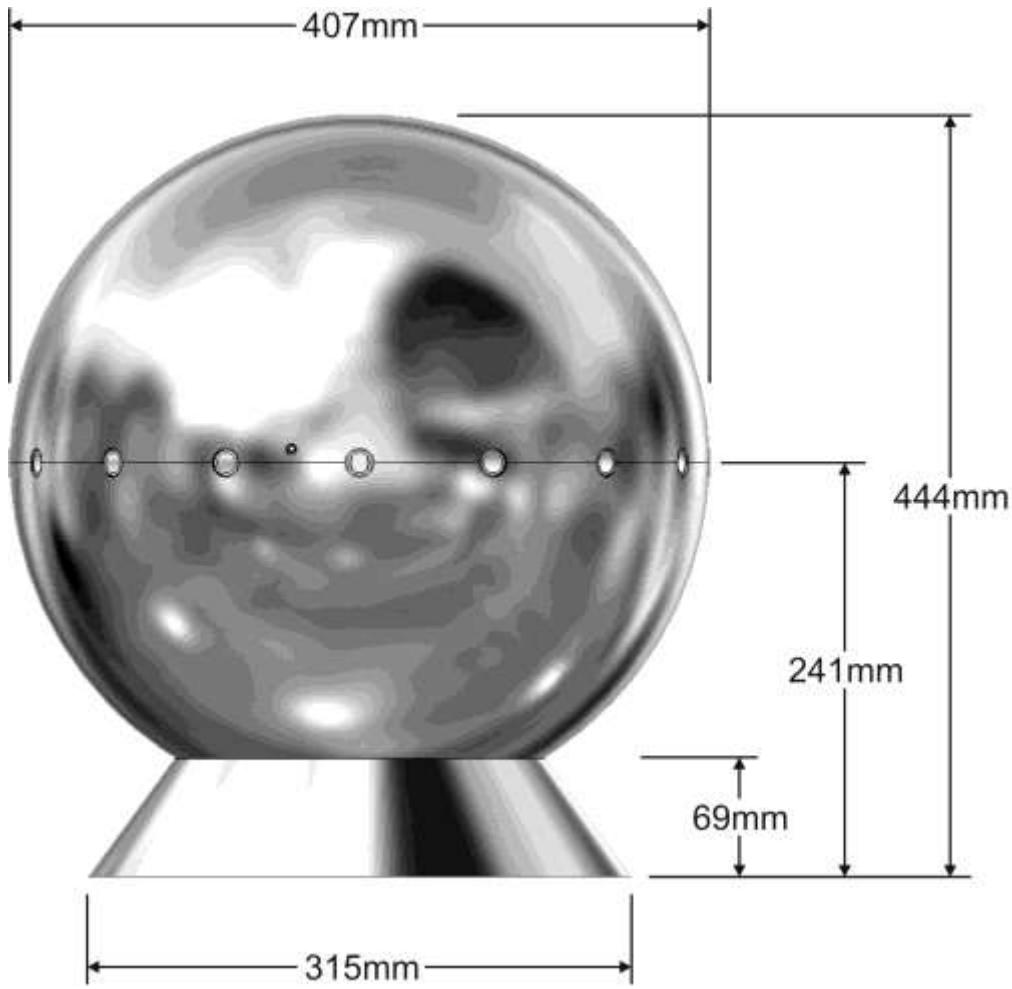

SPECIFICATION

Size	425mm diameter sphere
Weight	25 kilos
Temperature Range	100°C to 1300°C
No. of Calibration Points	8 normal - 16 to special requirements
Diameter of Sensors	Up to 8mm (others by arrangement)
Depth of immersion	200mm
Accuracy	±0.25°C at 1000°C (Using comparison techniques)
Warm-up times*	1 hour to 700°C 3 hours to 1300°C
Stabilization time*	1 hour to ±0.25°C
Power supply	240V, 50Hz 3KW Typically Single Phase
Ambient Operating Temp	0 – 50°C <70%RH

*These times may increase as the windings age or if the supply voltage is low.

SPECIAL FEATURES

The Saturn is normally supplied 240V, 50Hz, 3 KW with 8 sensor insertion points, one of which is used to house the control thermocouple. Eight tubes with a nominal internal diameter of 6mm have been found to give a very good and stable performance. It is the configuration around which the specification has been written.

To special order, the following options are available:

1. **16 Thermocouple Inserts:** Because of the extra thermal mass involved in offering this option to the same accuracy, an extra 30 minutes should be allowed for full stabilization.
2. **Larger thermocouple inserts:** Inserts of up to 10mm diameter can be accommodated in the furnace. Please contact ISOTECH for details.
3. **A PC interface is included.**

EACH UNIT COMPRISES

1. Saturn Furnace Model 877
2. Saturn Spider
3. Controller
4. Spare set of Windings
5. Thermocouple
6. User Maintenance Manual/Guarantee

PRECAUTIONS

Some precautions should be noted as follows:-

1. Due to the nature that the furnace is used the outer surface will become hot during operation at elevated temperatures.
2. Thermal Shock: - The materials used in the furnace have been especially selected for their purity and ability to withstand Thermal Shock. However, if a cold sensor is introduced into the furnace at high temperatures it should be inserted slowly, allowing the sensor to warm-up in, say 1 cm steps. Failure to observe the above can cause fracture of the tube into which it was being inserted. If this happens, it will not impair the accuracy of the rest of the system, but will reduce its capacity. New central equalising spheres are available from ISOTECH.
3. Over Temperature: - All the materials used in the construction of the furnace have been rated to 1,400°C. However, at these temperatures the life expectancy of the heater windings for example are very short. We therefore recommend an upper temperature of 1300°C for the bath.
4. Electrical Noise Pick-Up:- At high temperatures all ceramics have a reduced insulation value and hence conduct more electricity. This means that at temperatures from in excess of 700°C an increasing amount of 'noise' or electrical interference can be noticed on thermocouple outputs.

Three techniques can be used to eliminate this problem.

The first is to use a filter circuit; the second is to momentarily switch off the furnace heater whilst the thermocouple reading is taken. Alternatively an isolation transformer can be used to reduce the electrical leakage.

5. The furnace must be mounted on a suitable solid flat surface, horizontal to within $\pm 5^\circ$.

 **CAUTION**

Before switching on, check that there is approximately 20Ω between the furnace heater windings and greater than 5Megohms between windings and outer furnace case.

Assuming this is so you may now commission the furnace.

Please read the operating instructions carefully before proceeding.

ON ARRIVAL

On unpacking the Saturn you will find 4 parts:-

1. The Controller.
2. The furnace.
3. The equalizing sphere complete with its pockets.
4. A packet containing the control thermocouple, a spare set of windings and this instruction book.

To assemble the furnace, use the following procedure:-

- a. Carefully remove all the packing material.
- b. Stand the furnace on a flat surface and carefully unscrew the upper half of the outer sphere.
- c. Lift off the upper half of the sphere and the ceramic fibre insulation – dust precautions should be taken at this point.
- d. You will then see the hollow half of the inner sphere containing the heater windings.
- e. Two wires come from the top of the hollow sphere. Without disturbing these wires, carefully lift the upper hemisphere from its locating pegs and slide in the equalising block with its pockets. This normally requires two people.

Carefully position the equalising block until it sits correctly in the grooves provided and is symmetrically placed inside the furnace. Use some small pieces of insulation (supplied) to pack underneath the pockets so they sit on a soft bed of insulation rather than the ceramic heater support. This protects the pockets and improves the performance.

Beneath the furnace is an adjustment which will allow you to adjust the height of the heater winding ceramic. Adjust so that the sphere re-assembles without undue pressure on the equalizing block.

- f. Reassemble the furnace.
- g. Unpack the controller and connect the white cable with the IP65 connector to the white cable from the lower half of the furnace using the colour coded connector.
- h. Connect to a suitable electrical supply. Check the ratings plate on the controller for details.
- i. Push the control thermocouple into one of the pockets 150mm to the mark on the thermocouple and connect to the thermocouple input of the controller.

It is important not to fully immerse the control sensor into the equalising block pocket. Doing this will create a large thermal lag between the controller and the heaters thus introducing instability and the very long delay in reaching the setpoint.

COMMISSIONING

During its trip to you, the package containing the furnace may have become damp, therefore, we recommend the following initial procedure:-

1. Switch on the furnace/controller and set the temperature to 100°C. Allow the temperature to reach 100°C and stabilise there for 2 hours.
2. Increase the set temperature to 200°C. Allow 2 hours for stabilisation.
3. Increase the temperature in 100°C steps allowing 1 to 2 hours between each change until the furnace has reached 1,000°C.

Your Saturn is now ready for use!

SAMPLE RESULTS

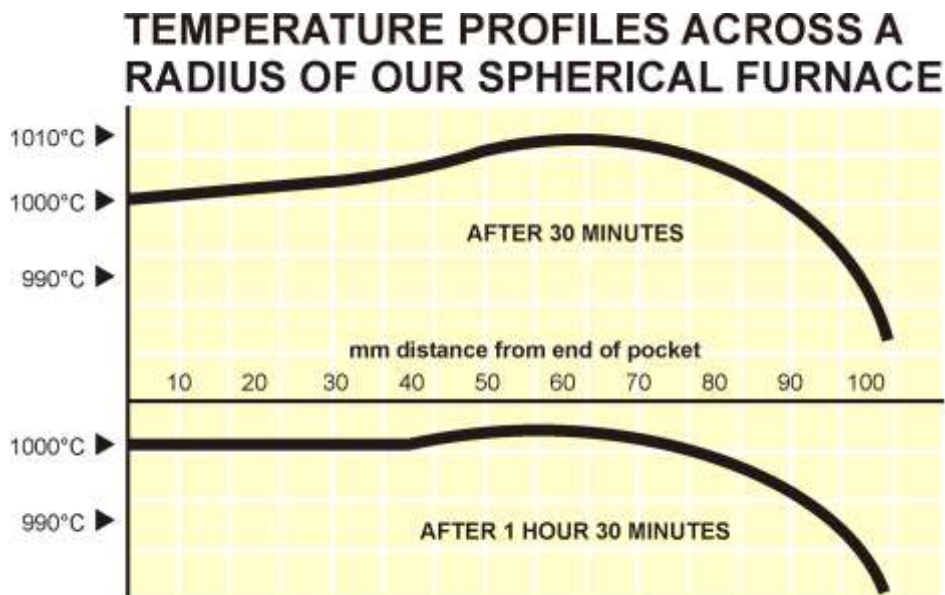

USING THE CONTROLLER

FRONT PANEL LAYOUT

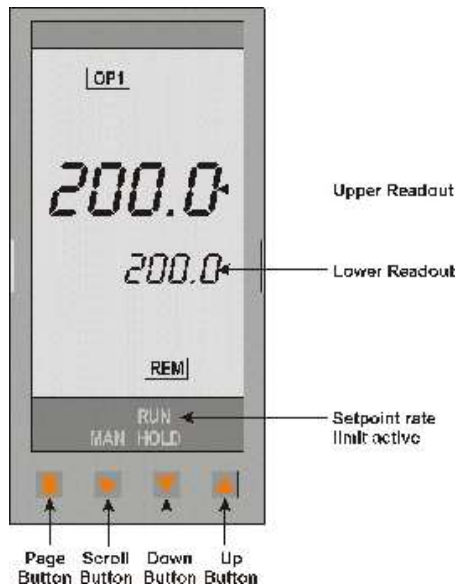

The Temperature Controller

The controller has a dual display, the upper display indicates the nominal block temperature, and the lower display indicates the desired temperature or setpoint.

Altering the Setpoint

To change the setpoint of the controller simply use the UP and DOWN keys to raise and lower the setpoint to the required value. The lower display changes to indicate the new setpoint.

ADVANCED CONTROLLER FEATURES

Setpoint Ramp Rate

By default the bath is configured to heat and cool as quickly as possible. There may be some calibration applications where it is advantageous to limit the heating or cooling rate.

An example might be when testing bimetallic thermostats, by forcing the bath to heat at a controlled rate it is easier to determine the temperature at which the thermostat changes state.

The bath can have its heating rate limited with the Setpoint Ramp Rate feature. This feature is accessed from the Scroll key. Depress the key until the display shows,

SPrr

On the Upper Display, the lower display will show the current value from OFF (default) to 999.9. The desired rate is set here with the UP and DOWN keys, the units are °C/min.

When the SPrr is active the controller display will show "RUN", the lower setpoint display will now automatically update with the current value, known as the working setpoint. The setpoint can be seen by pressing either the UP and DOWN key.

The Setpoint ramp rate operates when the bath is heating and cooling.

Instrument Address

The controller has a configurable "address" which is used for PC communications. Each instrument has an address, this allows several instruments to be connected in parallel on the same communications bus. The default value is 1. This address would only need to be changed if more than one bath is connected to the same PC port.

To check the Address value press the scroll key until the top display indicates,

Addr

The lower display will show the current value that can be modified with the UP and DOWN keys.

Monitoring the Controller Status

A row of beacons indicate the controllers status as follows,

OPI	Heat Output
REM	This beacon indicates activity on the PC interface

Units

Momentary pressing the Scroll key will show the controller units °C or °F.

DIAGNOSTIC ALARMS

Diagnostic alarms indicate a possible fault within the controller or connected devices.

Display shows	What it means	What to do about it
EE.Er	<i>Electrically Erasable Memory Error:</i> The value of an operator or configuration parameter has been corrupted	Contact Isotech
S.br	<i>Sensor Break:</i> Input sensor is unreliable or the input signal is out of range.	Contact Isotech
HW.Er	<i>Hardware error :</i> Indication that a module is of the wrong type, missing or faulty	Contact Isotech
Err1	<i>Error 1: ROM self-test fail</i>	Consult Isotech
Err2	<i>Error 2: RAM self-test fail</i>	Consult Isotech
Err3	<i>Error 3: Watchdog fail</i>	Consult Isotech
Err4	Error 4: Keyboard failure Stuck button, or a button was pressed during power up.	Switch the power off and then on without touching any of the controller buttons.
Err5	<i>Error 5: Input circuit failure</i>	Consult Isotech
Pwr.F	<i>Power failure.</i> The line voltage is too low	Check that the supply to the controller is within the rated limits

Additional Information;

1. If the input is too high HHHHH will be displayed.
2. If the input is too low LLLLL will be displayed.

USING THE PC INTERFACE

The ^{Plus} models include an RS422 PC interface, a special converter cable that allows use with a standard RS232 port. When using the bath with an RS232 port it is essential that this converter cable is used. Replacement cables are available from Isotech, part number ISO-232-432. A further lead is available as an option, Part Number ISO-422-422 lead which permits up to 5 instruments to be daisy chained together.

The benefit of this approach is that a number of calibration baths may be connected together in a "daisy chain" configuration - and then linked to a single RS232, see diagram.



Note: The RS 422 standard specifies a maximum lead length of 1200M (4000ft). A true RS422 port will be required to realise such lead lengths. The Isotech conversion leads are suitable for maximum combined lead lengths of 10M that is adequate for most applications.

CONNECTIONS

For RS232 use simply connect the Isotech cable, a 9 to 25 pin converter is included to suit PCs with a 25 pin serial converter.

RS422 Connections

Pin	Connection
4	Tx+ A
5	Tx- B
8	Rx+ A
9	Rx- B
1	Common

CAL NOTEPAD

Cal Notepad can be used to log and display values from the Dry Blocks and an optional temperature indicator such as the milliK or TTI-10. The software requires Windows 9X, XP, a minimum of 5Mb of free hard drive space and free serial ports for the instruments to be connected.

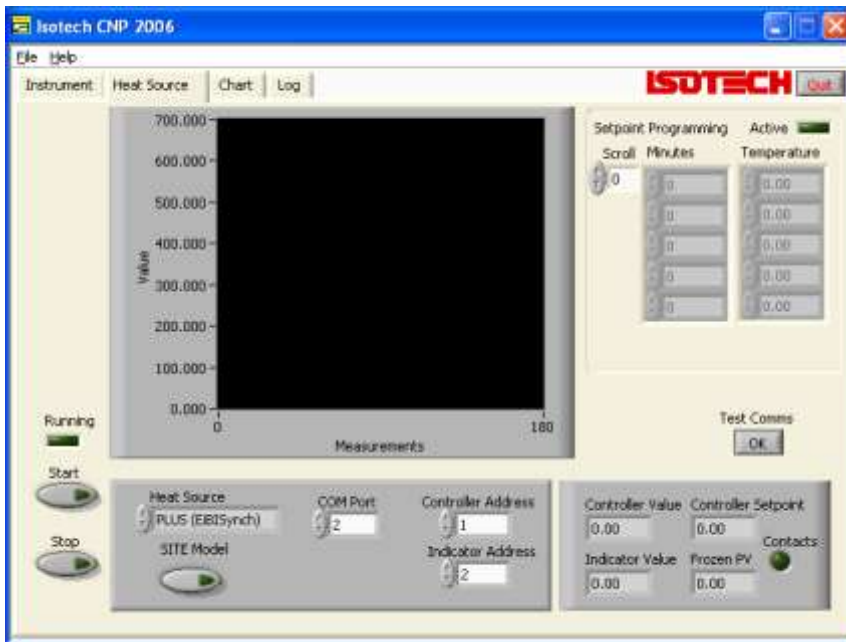

DEVELOPMENT

Cal NotePad was developed by Isothermal Technology using LabVIEW from National Instruments. The license details are shown on the download page and in the Cal Notepad manual.

HOW TO INSTALL CAL NOTEPAD

1. Download the ZIP from <http://www.isotech.co.uk/downloads> (7.6Mb)
2. Extract the files to a temporary folder
3. Run setup.exe



4. Follow the prompts which will install the application, a user manual with setup information and the necessary LabVIEW run time support files.
5. Should you ever need to uninstall the software then use the Add/Remove Programs option from the Control Panel.

PROTOCOL

The instruments use the "Modbus Protocol"

If required, e.g. for writing custom software the technical details are available from our Document Library at <http://www.isotech.co.uk>

GETTING THE BEST FROM YOUR SATURN

INTRODUCTION

Although every effort is made to get complete symmetry inside the Saturn. Variations in tube wall thickness, winding spacing, ceramic densities inevitably mean that there is a small consistent and reproducible profile round the inner equalizing sphere.

After assembly, the following test procedure will allow an evaluation of this profile. The profile will be consistent throughout the life of the furnace and enable calibration to be performed to an accuracy of 0.25°C.

1. Set temperatures to 100°C and allow 1 to 1.5 hours for stabilisation to occur.
2. Make two thermocouples type R or S, (or use two model I600s available from ISOTECH).
3. Place 1 in a designated pocket, place the second thermocouple in each of the other pockets in turn, taking readings in each pocket compared to the standard pocket.
4. Repeat survey at 200°C intervals.
5. Use the survey to provide a correction factor to the results subsequently obtained.

SATURN MODEL 877 PERFORMANCE REPORT - APPENDIX I

A. STABILITY

"The ability of a measurand to maintain constant its metrological characteristics".

Short term	less than 0.1°C
Long term	typically 1°C/year

The function of the Saturn requires explanation. It comprises a spherical heater whose temperature is controlled.

At the centre of the sphere is solid ball of alumina with 8 or 16 hollow tubes penetrating to the centre of the ball.

Once the furnace has settled down the measurand (the ball in the middle) changes its temperature by less than 0.1°C in 10 minutes and typically 0.1°C/hour.

These times are considered sufficient for a survey of pockets, or a set of results.

Long term stability in this case is defined by the calibrated thermocouple's performance which for a type R thermocouple should be about 1°C per year or better at 1000°C provided the atmosphere is oxidizing.

B. MEASUREMENT UNCERTAINTY

"An estimate characterizing the range of values within which the true value of a measurand lies".

As measured by a small mass exposed junction Type R Thermocouple calibrated by our National Laboratory, the measurement uncertainty is estimated at 0.5°C.

C. TEMPERATURE DISTRIBUTION

Two type R thermocouples as 'B' above were used to survey the pocket temperatures at various set temperatures.

A profile exists which is slightly different for each Saturn, depending on the pocket configuration, the size and material of the thermocouples being evaluated.

Once characterized, the repeatability of results is typically $\pm 0.25^\circ\text{C}$.

An evaluation giving a complete survey of the temperature profile of a Saturn is available on request.

D. DISSIMILAR PROBES

The effects of sensor length and reproducibility must be taken into account when assessing the apparent errors in calibration results.

A tutorial called "Denver Lecture" is available on request.

E. ACCURACY OF MEASUREMENT

"The closeness of the agreement between the result of a measurement and the value of the measurand".

This value will be a statistical combination of A.B.C.D. above.

PLEASE NOTE

The Saturn will give large errors and may be damaged by large diameter thermocouples.

The high temperature sodium heat pipe furnace is the best furnace for large diameter thermocouples. Model No. ITL-M-17702.