



**Advanced Test Equipment Rentals**  
**www.atecorp.com 800-404-ATEC (2832)**

**RTE-140 Refrigerated  
Bath/Circulator  
With Analog/Digital Controller**

Thermo NESLAB Manual P/N 000022  
Rev. 11/17/00

**Instruction and Operation Manual**



# RTE-140 Refrigerated Bath/Circulator Instruction and Operation Manual

## Table of Contents

<b>PREFACE</b>	
	Compliance ..... 2
	Unpacking ..... 2
	Warranty ..... 2
	NES-care ..... 2
	After-sale Support ..... 2
<b>SECTION I</b>	
<b>Safety</b>	
	Warnings ..... 3
<b>SECTION II</b>	
<b>General Information</b>	
	Description ..... 4
	Specifications ..... 4
<b>SECTION III</b>	
<b>Installation</b>	
	Site ..... 5
	Electrical Requirements ..... 5
	Plumbing Requirements ..... 6
	Fluids ..... 8
	Filling Requirements ..... 8
<b>SECTION IV</b>	
<b>Controllers</b>	
	Controllers ..... 9
	Start Up ..... 9
	Shut Down ..... 10
	High Temperature/Low Liquid Level Safety ..... 11
	15-Pin Accessory Connector ..... 12
<b>SECTION V</b>	
<b>Maintenance</b>	
	Service Contracts ..... 13
	Condenser ..... 13
	Reservoir Cleaning ..... 14
	Algae ..... 14
<b>SECTION VI</b>	
<b>Troubleshooting</b>	
	Checklist ..... 15
	Service Assistance and Technical Support ..... 15
<b>APPENDIX NESCOM SOFTWARE</b>	
<b>SECTION VII</b>	
<b>Warranty</b>	..... 17

## Preface

**Compliance** Products tested and found to be in compliance with the requirements defined in the EMC standards defined by 89/336/EEC as well as Low Voltage Directive (LVD) 73/23/EEC can be identified by the CE label on the rear of the unit. The testing has demonstrated compliance with the following directives:

LVD, 73/23/EEC	Complies with UL 3101-1:93
EMC, 89/336/EEC	EN 55011, Class A Verification
	EN 50082-1:1992
	IEC 1000-4-2:1995
	IEC 1000-4-3:1994
	IEC 1000-4-4:1995

For any additional information refer to the Letter of Compliance that shipped with the unit (Declaration of Conformity).

**Unpacking** Retain all cartons and packing material until the unit is operated and found to be in good condition. If the unit shows external or internal damage, or does not operate properly, contact the transportation company and file a damage claim. Under ICC regulations, this is your responsibility.

**Warranty** Units have a warranty against defective parts and workmanship for one full year from date of shipment. See back page for more details.

### ***NES-care* Extended Warranty Contract**

- Extend parts and labor coverage for an additional year.
- Worry-free operation.
- Control service costs.
- Eliminate the need to generate repair orders.
- No unexpected repair costs.

Other contract options are available. Please contact Thermo NESLAB for more information.

### **After-sale Support**

Thermo NESLAB is committed to customer service both during and after the sale. If you have questions concerning the operation of your unit or the information in this manual, contact our Sales Department. If your unit fails to operate properly or if you have questions concerning spare parts or Service Contracts, contact our Service Department.

Before calling, *please* refer to the serial number label on the rear of the case top to obtain the following information:

- *BOM number* \_\_\_\_\_

- *Serial number* \_\_\_\_\_

## Section I Safety

### Warnings

Make sure you read and understand all instructions and safety precautions listed in this manual before installing or operating your unit. If you have any questions concerning the operation of your unit or the information in this manual, contact our Sales Department.

**Performance of installation, operation, or maintenance procedures other than those described in this manual may result in a hazardous situation and may void the manufacturer's warranty.**

**Transport the unit with care. Sudden jolts or drops can damage the refrigeration lines. The unit weighs approximately 99 pounds (45 kilograms) and should be transported with equipment designed to lift that weight.**

**Observe all warning labels.**

**Never remove warning labels.**

**Never operate damaged or leaking equipment.**

**Never operate the unit without bath fluid in the bath.**

**Above 115°C, never use pure ethylene glycol as a bath fluid.**

**For 220 - 240 volt units supplied without a line cord, use a harmonized (HAR) grounded 3-conductor cord, type H 05 V V - F , with conductors listed below. A suitable cord end is required for connecting to the equipment (see unit socket) and must terminate with an IEC approved plug for proper connection to power supply.**

**Example: Nominal 1.0 mm<sup>2</sup> cross section rated 10 Amps**

**Unit Socket: IEC - 320 C13**

**Always turn off the unit and disconnect the line cord from the power source before performing any service or maintenance procedures, or before moving the unit.**

**Always empty the bath before moving the unit.**

**Never operate equipment with damaged line cords.**

**Refer service and repairs to a qualified technician.**

In addition to the safety warnings listed above, warnings are posted throughout the manual. These warnings are designated by an exclamation mark inside an equilateral triangle with text highlighted in bold print. Read and follow these important instructions. Failure to observe these instructions can result in permanent damage to the unit, significant property damage, personal injury or death.

## Section II General Information

### Description

The RTE-140 Refrigerated Bath/Circulators are designed to provide temperature control for applications requiring a fluid work area or pumping to an external system.

Units consist of a non-CFC air-cooled refrigeration system, circulation pump, seamless stainless steel bath, work area cover, and a temperature controller.

### Specifications

<b>Temperature Range</b> <i>Analog controller</i> <i>Digital controller</i>	-40°C to +100°C -40°C to +150°C
<b>Temperature Stability<sup>1,2,3</sup></b> <i>Analog controller</i> <i>Digital controller</i>	±0.1°C ±0.05°C
<b>Cooling Capacity<sup>4</sup></b> <i>Watts</i> <i>BTU/H</i>	500 @ 0°C 1705 @ 0°C
<b>Pump Capacity</b>	15 lpm at 0' (0 M) 0 lpm at 16' (4.9 M)
<b>Heater</b> <i>Watts</i> <i>50 Hz Models</i>	800 1000
<b>Bath Work Area</b> <i>(L x W x D)</i> <i>Inches</i> <i>Centimeters</i>	4 3/4 x 8 x 5 12.1 x 20.3 x 12.7
<b>Bath Volume</b> <i>Liters</i>	7.0
<b>Case Dimensions</b> <i>(H x W x D)</i> <i>Inches</i> <i>Centimeters</i>	26 x 12 3/8 x 19 66.0 x 31.4 x 48.3
<b>Power Requirements<sup>5</sup></b>	115 V, 60 Hz, 16 Amp 220/240 V, 50 Hz, 8.6 Amp

- Specifications listed for units operating at 20°C bath temperature using water.
- For operation below 0°C, covering the bath work area may improve stability.
- For some applications, agitation and stability above ambient temperatures may be improved by connecting a small length of hose between the PUMP INLET and PUMP OUTLET connections on the rear of the unit.
- 60 Hertz units, 375 watts for 50 Hertz. Specifications listed for units operating at 0°C bath temperature, +20°C (+70°F) ambient, using fluid with a specific gravity of 0.5
- Power Board Transformer Fuse—Analog T 0.5A 250V (Qty 1), Digital T 0.8A 250V (Qty 2)  
[T=Time Delay]

## Section III Installation

### Site

The indentations on the sides of the unit are designed to function as handles. Lift the unit by the handles and locate it on a sturdy table or bench top. Ambient temperatures should be inside the range of +50°F to +104°F (+10°C to +40°C).



**Never place the unit in a location where excessive heat, moisture, or corrosive materials are present.**

The unit has an air-cooled refrigeration system. Air is drawn through the front panel and discharged through the rear panel. The unit must be positioned so the air intake and discharge are not impeded. A minimum clearance of 12 inches (30 centimeters) at the front and rear of the unit is necessary for adequate ventilation. Inadequate ventilation will reduce cooling capacity and, in extreme cases, can cause compressor failure.

Excessively dusty areas should be avoided and a periodic cleaning schedule should be instituted (see Section VI, Cleaning).

The unit will retain its full rated capacity in ambient temperatures up to approximately +68°F (+20°C). Above +68°F, derate the cooling capacity 1% for every 1°F above +68°F to a maximum ambient temperature of 104°F. In terms of Celsius, derate the cooling capacity 1% for every 0.5°C above +20°C, to a maximum ambient temperature of +40°C.

### Electrical Requirements



**Line voltage may be easily accessible inside the pump/control box. Always unplug the unit prior to removing pump/control box cover.**

Refer to the serial number label on the rear of the unit to identify the specific electrical requirements of your unit.

Ensure the voltage of the power source meets the specified voltage,  $\pm 10\%$ .

The unit construction provides extra protection against the risk of electric shock by grounding appropriate metal parts. The extra protection may not function unless the power cord is connected to a properly grounded outlet. It is the user's responsibility to assure a proper ground connection is provided.



**For 220 - 240 volt units supplied without a line cord, use a harmonized (HAR) grounded 3-conductor cord, type H 05 V V - F, with conductors listed below. A suitable cord end is required for connecting to the equipment (see unit socket) and must terminate with an IEC approved plug for proper connection to power supply.**

**Example: Nominal 1.0 mm<sup>2</sup> cross section rated 10 Amps**

**Unit Socket: IEC - 320 C13**

## Plumbing Requirements



**Ensure the unit is off before connecting tubing to the unit.**

**To prevent damage to the plumbing lines, always support the 3/4" fittings while installing/removing the pumping caps and lines.**

### Hose Connections

The pump connections are located at the rear of the pump box and are labelled PUMP INLET and PUMP OUTLET. These connections are bent upward so the recirculating fluid will drain back into the reservoir when the hoses are disconnected. Both connections are capped with stainless steel serrated plugs.

The pump lines have 1/4" male pipe threads for mating with standard plumbing fittings. For your convenience two stainless steel adapters, 1/4" female pipe thread to 3/8" O.D. serrated fitting, are provided. (To assure proper fit, they should be installed using Teflon® tape around the threads.)

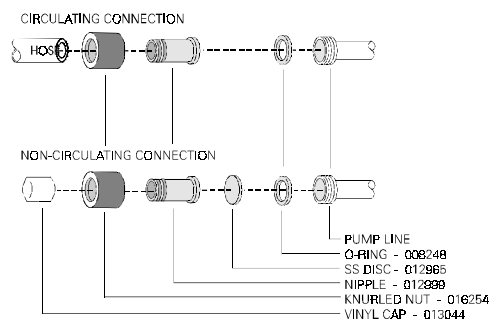

Flexible tubing, if used, should be of heavy wall or reinforced construction. Make sure all tubing connections are securely clamped. Avoid running tubing near radiators, hot water pipes, etc. If substantial lengths of tubing are necessary, insulation may be required to prevent loss of cooling capacity.

Tubing and insulation are available from Thermo NESLAB. Contact our Sales Department for more information (see Preface, After-sale Support).

It is important to keep the distance between the unit and the external system as short as possible, and to use the largest diameter tubing practical. Tubing should be straight and without bends. If diameter reductions must be made, make them at the inlet and outlet of the external system, not at the unit.

If substantial lengths of cooling lines are required, they should be pre-filled with bath fluid before connecting them to the unit. This will ensure that an adequate amount of fluid will be in the bath once it is in operation.

### Pumping

The pump is designed to deliver a flow of 15 liters/minute (4 gallons minute) at 0 feet head. To prevent external circulation, the PUMP INLET and PUMP OUTLET lines on the rear of the unit are capped. The caps must be removed when external circulation is required.

To properly secure external hose connections to the unit, wrap Teflon® tape around the pipe line threads before installation. Once the hose connections are made, the hoses must be properly plumbed to an external system. *It is important the bath is not in operation until all plumbing is complete.*

**NOTE:** To increase agitation in the bath when not circulating externally, connect a short loop of hose between the inlet and outlet lines.

If the bath is not used for external circulation, make sure the stainless steel caps are in place prior to operating the bath.

### Circulating to an open container

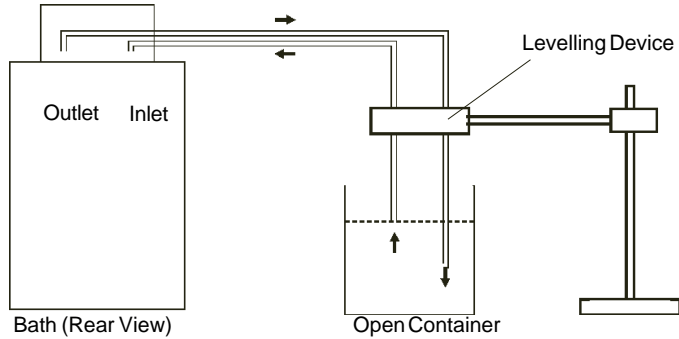

A stainless steel leveling device is available to aid circulation to an open vessel. Contact our Sales Department for more information (see Preface, After-sale Support).

Support the leveling device over the open container with a ringstand. Stagger the tubes in the leveling device so one tube is submerged in the vessel fluid, and the other tube is level with the fluid surface. Connect the deeper tube to the PUMP OUTLET and the shorter tube to the PUMP INLET.

Adjust the flow rate using the accessory flow control valve connected to the PUMP OUTLET, or by partially restricting the outlet tubing. When properly adjusted, the pump inlet will draw an occasional air bubble to prevent over flow, and the pump outlet will force fluid through the submerged tube to prevent aeration of the vessel.

To avoid siphoning the bath work area when the unit is shut off, lift the leveling device out of the vessel and above the level of the unit.

### Circulating through two closed loops

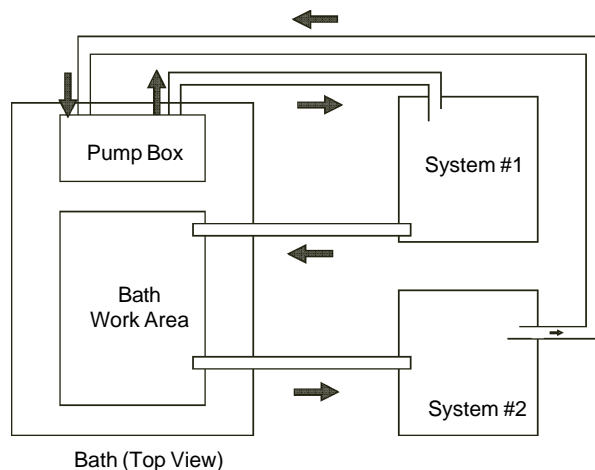

The pump can be used to circulate through two closed loop systems. Connect the shortest practical length of flexible tubing from the PUMP OUTLET to the inlet of external system #1. Connect the outlet of system #1 directly into the bath work area. Connect tubing from the bath work area to the inlet of system #2. Connect the outlet of system #2 to the PUMP INLET.



## Drain



**Ensure the temperature of the bath fluid is safe before draining the unit.**

The unit is equipped with a drain located at the back of the unit at the base of the bath. The drain has ¼ inch male pipe threads and is capped with a stainless steel plug. To drain the reservoir simply remove the cap.

To assure proper fit when replacing the cap, be sure to line the threads with Teflon® tape.

## Fluids



**Never use flammable or corrosive fluids with this unit.**

The selected fluid must have a viscosity of 50 centistokes or less at the lowest operating temperature.

Filtered tap water is the recommended fluid for operation from +8°C to +80°C.

For operation from +8°C to -30°C, a 50/50 mixture, by volume, of filtered tap water and laboratory grade ethylene glycol is suggested.

Above +80°C and below -30°C, the user is responsible for fluids used.



**Never use pure ethylene glycol as a bath fluid. A minimum 80/20 mixture of Ethylene Glycol and filtered tap water is allowed.**

## Filling Requirements

The bath work area has a high and low level marker to guide filling. The markers are 1 inch horizontal slits located in the center of the stainless steel baffle separating the work area and the pump assembly. The correct fluid level falls between these two markers. The heating and cooling coils will be exposed and may become damaged if the correct fluid level is not provided.

When pumping to an external system, keep extra fluid on hand to maintain the proper level in both the circulating lines and the external system.



**Never run the unit when the work area is empty. Avoid overfilling. Overfilling the bath may damage the insulation and affects stability as well as low-end performance.**

## Section IV Controllers

### Controllers

Two standard temperature controllers are available with the unit: Analog and Digital. This section explains the installation and operation of the controllers.

### Start Up

Before starting the unit, check all electrical and plumbing connections and make sure the work area has been properly filled with bath fluid.

To start the unit press the I/O switch on the side of the controller to the **I** (power on) position. The pump will start and the POWER LED will light.

220V units have a circuit breaker instead of a switch. The circuit breaker is labeled **I** (power on) and **O** (power off). Ensure the circuit breaker is in the **I** position.

The REFRIGERATION switch should be ON for normal operation below 40°C.



**Operating the refrigeration above 40°C could result in premature compressor failure.**

The HEAT LED indicates the status of the heater. As the temperature of the fluid in the bath approaches the temperature setpoint, the lamp will cycle on and off to indicate the approximate duty cycle of the heater.

### Analog Temperature Adjustment

Units with Analog temperature controller are equipped with a glass tube thermometer. Insert the thermometer in the grommet located on the left side of the work area.

To adjust the bath temperature, turn the dial to the desired setpoint. Use the bath thermometer to make fine adjustments to the bath temperature.

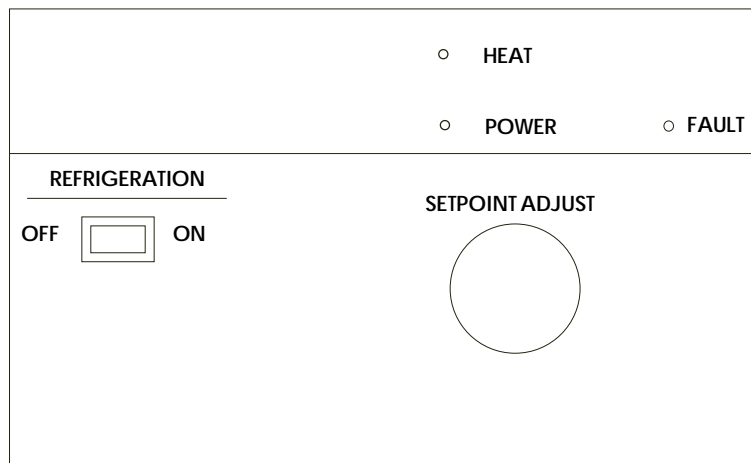

Analog Controller

### Digital Temperature Adjustment

To display the temperature setpoint, press the DISPLAY switch. To adjust the setpoint, press and hold the DISPLAY switch and turn the COARSE and FINE dials until the temperature setpoint is indicated on the LED display.

**NOTE:** Inadvertent movement of the COARSE and FINE dials, regardless of the position of the DISPLAY switch, will result in a change of the setpoint. The change will not be immediately reflected on the LED display unless the DISPLAY switch is pressed. The display will eventually change as the unit responds to the new setpoint.

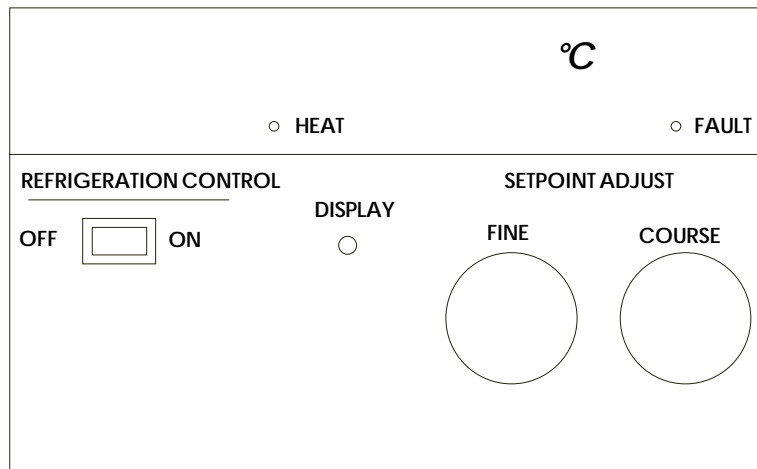

Digital Controller

### Shut Down

When the unit is shut off wait approximately five minutes before restarting. This allows time for the refrigeration pressures to equalize. If the pressures are not allowed to equalize, the compressor will short-cycle (clicking sound) and no cooling will occur.

## High Temperature/ Low Liquid Level Safety

To protect your application, the adjustable High Temperature/Low Liquid Level Safety (HIGH TEMP/LOW LEVEL) ensures the heater will not exceed temperatures which can cause serious damage to your unit. A single temperature sensor, located on the heater coils in the bath, monitors both conditions. A High Temperature/Low Liquid Level fault occurs when the temperature of the sensor exceeds the set temperature limit.

In the event of a fault, the unit will shut down. The cause of the fault must be identified and corrected before the unit can be restarted.

The safety is not pre-set and must be adjusted during initial installation.

To set the safety, locate the HIGH TEMP/LOW LEVEL SAFETY adjustment dial on the right side of the pump box. Turn the dial fully clockwise and press the red RESET switch. The RESET switch is located next to the adjustment dial.

Start the unit. Adjust the setpoint for a few degrees higher than the highest desired fluid temperature and allow the bath to stabilize at the temperature setpoint. Turn the HIGH TEMP/LOW LEVEL SAFETY dial counter-clockwise until you hear a click and the unit shuts down. The red FAULT LED on the temperature controller will light to indicate a fault has occurred.

Cool the bath and then, without moving the adjustment dial, press the red RESET switch.

**NOTE:** The minimum high temperature safety setting is 50°C.

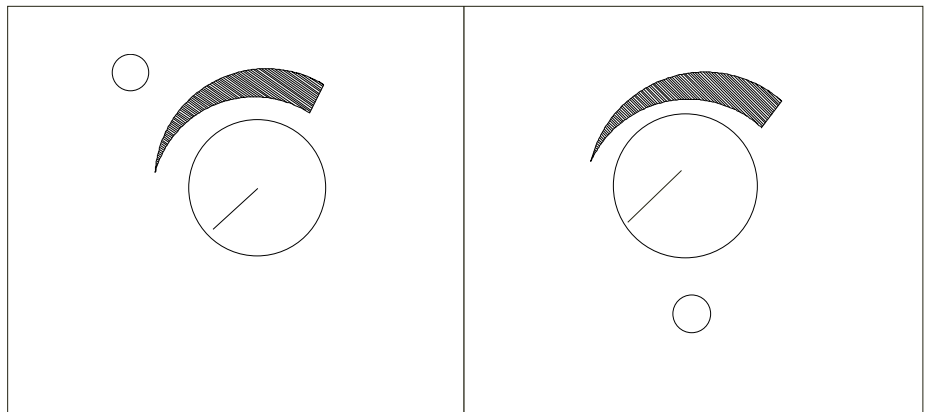

High Temperature/Low Liquid Level Safety (Typical)

## 15-Pin Accessory Connector

Digital units are equipped with a 15 pin D-subminiature female receptacle on the right side of the power box. An ENABLE/DISABLE switch is located just below the receptacle. Place the switch to the ENABLE position to control the bath via the receptacle connection. (The sensor temperature and setpoint, pin 7 and 8, can be read with the switch in either position.) The pin-out information is listed below.

Pin #	Function
1	Chassis ground.
2	No connection.
3	Span +. Indicates the maximum setpoint value the unit can be set to operate. The temperature scale is 10mV/°C, referenced to analog ground, pin 6 (example: +350mV = +35.0°C).
4	Span -. Indicates the minimum setpoint value the unit can be set to operate. The temperature scale is 10mV/°C, referenced to analog ground, pin 6 (example: +50mV = +5.0°C).
5	No connection.
6	Analog ground. The analog ground is physically separated from the power ground throughout the unit. To prevent offsets that result from ground currents, the analog and power grounds are only connected at the unit's power supply. Analog ground should only be used as a reference pin.
7	Sensor temperature (current limited through 2.7K OHM resistor). The fluid temperature, as measured by the controller's sensor located in the reservoir, can be read at this pin. The temperature scale is 10mV/°C, referenced to analog ground, pin 6 (example: +150mV = +15.0°C).
8	Setpoint out. The present temperature setpoint can be read at this pin. The temperature scale is 10mV/°C, referenced to analog ground, pin 6 (example: +150mV = +15.0°C).
9	Power Ground.
10	No connection.
11	No connection.
12	Digital display (input only). An external voltage can be displayed on the operator panel digital display by applying the voltage to this pin. The display has a low input resistance and a full scale rating of ±1.99VDC. Input is referenced to analog ground, pin 6. The maximum voltage applied to the display should be limited to ±2VDC.
13	- 5V. Power supply of -5VDC (15mA maximum).
14	+5V. Power supply of +5VDC (50mA maximum).
15	Setpoint in. The temperature setpoint can be controlled by applying a known voltage to this pin. The temperature scale is 10mV/°C, referenced to analog ground, pin 6 (example: +230mV = +23.0°C).

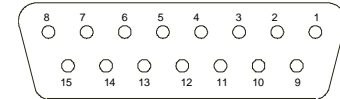

15 pin D-subminiature female receptacle

NOTE: With the switch in the ENABLE position and no input to pin 15, the bath will slowly go to the setpoint value set on the digital controller.

## Section V Maintenance



**To avoid electrical shock, disconnect the mains cord prior to removing any access panels or covers.**

### Service Contracts

Thermo NESLAB offers on-site Service Contracts that are designed to provide extended life and minimal down-time for your unit. For more information, contact our Service Department (see Preface, After-sale Support).

### Condenser

For proper operation, the unit needs to pull substantial amounts of air through a condenser. A build up of dust or debris on the fins of the condenser will lead to a loss of cooling capacity.

Periodic vacuuming of the condenser is necessary. To access the condenser the front grille must be removed.



**The unit must be turned off before the front panel is removed.**

All units have a two piece grille assembly. First remove the left (blue-colored) section by simply pulling it forward. Pull forward on the remaining (white-colored) section to remove it.

The frequency of cleaning depends on the operating environment. After initial installation, we recommend a monthly visual inspection of the condenser. After several months, the frequency of cleaning will be established.

## Reservoir Cleaning

Routine cleaning can be achieved by simply sponging down the seamless stainless steel tank with tap water. (Dish washing detergent may be used but the tank must be thoroughly rinsed.)

To gain access to the entire reservoir the pump box and reservoir cover should be removed.

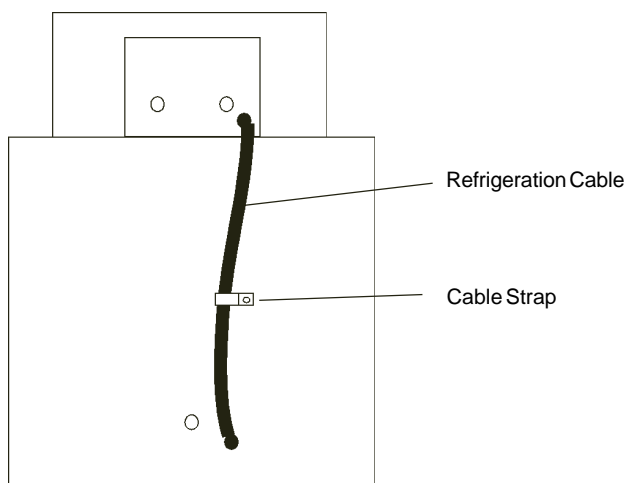

Remove the line cord from the rear of the unit and then remove the four screws (two on each side) securing the reservoir's cover.

To get slack on the refrigeration cable, remove the cable strap. The cable itself does not need to be disconnected.

Turn the cover assembly over and carefully place it on a supporting platform.

## Algae

To restrict the growth of algae in the bath, we recommend the bath cover be kept in place and that all circulation lines be opaque. This will eliminate the entrance of light required for the growth of most common algae.

Thermo NESLAB recommends the use of Chloramine-T, 1 gram per 3.7 liters.

## Section VI Troubleshooting

### Checklist

#### Unit will not start

Make sure the voltage of the power source meets the specified voltage,  $\pm 10\%$ . Refer to the serial number label on the rear of the unit to identify the specific electrical requirements of your unit.

Check the High Temperature/Low Liquid Level Safety. If the FAULT light is on, make sure the fluid level in the bath is between the marks in the baffle and the HIGH TEMP/LOW LEVEL SAFETY setting is greater than the fluid temperature. Push the RESET switch and attempt to restart.

#### Loss of cooling capacity

Check the position of the REFRIGERATION switch.

Be sure the cooling capacity of the unit has not been exceeded if circulating to an external system.

When the unit is shut off, wait approximately five minutes before restarting. This allows time for the refrigeration pressures to equalize. If the pressures are not allowed to equalize, the compressor will short-cycle (clicking sound) and no cooling will occur.

Proper ventilation is required for heat removal. Make sure ventilation through the front and rear panels is not impeded and the panels are free of dust and debris.

Ice build up on the cooling coils can act as insulation and lower the cooling capacity. Raise the temperature of the bath to de-ice the cooling coil and increase the concentration of non-freezing fluid.

#### No external circulation

Check for obstructions, kinks, or leaks in the circulation tubing.

Circulation will cease when the pump head has been exceeded.

### Service Assistance and Technical Support

If, after following these troubleshooting steps, your unit fails to operate properly, contact our Customer Service Department for assistance (see Preface, After-sale Support). In addition to arranging warranty service, our Service Department can provide you with a wiring diagram and a complete list of spare parts for your unit. Before calling, please obtain the following:

*Part number*

*Serial number*

*Voltage of unit*

*Voltage of power source*



## APPENDIX NEScom SOFTWARE

The Thermo NESLAB Communications Software is a user friendly software that allows you to automate your temperature control process. The software includes a 3½" disk, Comprehensive Operator's Manual and a toll-free number to a trained technical staff.

NEScom Software allows you to write custom temperature programs for our Digital or Microprocessor based temperature control apparatus. Choose upper or lower temperature limits and monitor system status with an alarm. NEScom can also record your results on a user selectable graph. NesCom must be used with an IBM or 100% compatible computer.

Select from easy to use product icons.

Create graphs and charts.

Easily configure ramping functions which set the setpoint over time.

View pop-up alarm windows which display if an alarm condition occurred.

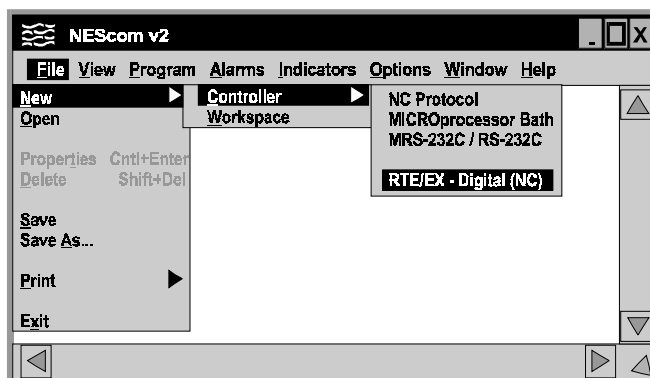

*Select software functions from the easy to use pulldown menus.*



*View a virtual controller screen which allows remote monitoring and operation of product control panel.*

## WARRANTY

Thermo NESLAB Instruments, Inc. warrants for 12 months from date of shipment any Thermo NESLAB unit according to the following terms.

Any part of the unit manufactured or supplied by Thermo NESLAB and found in the reasonable judgment of Thermo NESLAB to be defective in material or workmanship will be repaired at an authorized Thermo NESLAB Repair Depot without charge for parts or labor. The unit, including any defective part must be returned to an authorized Thermo NESLAB Repair Depot within the warranty period. The expense of returning the unit to the authorized Thermo NESLAB Repair Depot for warranty service will be paid for by the buyer. Thermo NESLAB's responsibility in respect to warranty claims is limited to performing the required repairs or replacements, and no claim of breach of warranty shall be cause for cancellation or rescission of the contract of sales of any unit. With respect to units that qualify for field service repairs, Thermo NESLAB's responsibility is limited to the component parts necessary for the repair and the labor that is required on site to perform the repair. Any travel labor or mileage charges are the financial responsibility of the buyer.

The buyer shall be responsible for any evaluation or warranty service call (including labor charges) if no defects are found with the Thermo NESLAB product.

This warranty does not cover any unit that has been subject to misuse, neglect, or accident. This warranty does not apply to any damage to the unit that is the result of improper installation or maintenance, or to any unit that has been operated or maintained in any way contrary to the operating or maintenance instructions specified in Thermo NESLAB's Instruction and Operation Manual. This warranty does not cover any unit that has been altered or modified so as to change its intended use.

In addition, this warranty does not extend to repairs made by the use of parts, accessories, or fluids which are either incompatible with the unit or adversely affect its operation, performance, or durability.

Thermo NESLAB reserves the right to change or improve the design of any unit without assuming any obligation to modify any unit previously manufactured.

THE FOREGOING EXPRESS WARRANTY IS IN LIEU OF ALL OTHER WARRANTIES, EXPRESSED OR IMPLIED, INCLUDING BUT NOT LIMITED TO WARRANTIES OR MERCHANTABILITY AND FITNESS FOR A PARTICULAR PURPOSE.

Thermo NESLAB'S OBLIGATION UNDER THIS WARRANTY IS STRICTLY AND EXCLUSIVELY LIMITED TO THE REPAIR OR REPLACEMENT OF DEFECTIVE COMPONENT PARTS AND Thermo NESLAB DOES NOT ASSUME OR AUTHORIZE ANYONE TO ASSUME FOR IT ANY OTHER OBLIGATION.

Thermo NESLAB ASSUMES NO RESPONSIBILITY FOR INCIDENTAL, CONSEQUENTIAL, OR OTHER DAMAGES INCLUDING, BUT NOT LIMITED TO LOSS OR DAMAGE TO PROPERTY, LOSS OF PROFITS OR REVENUE, LOSS OF THE UNIT, LOSS OF TIME, OR INCONVENIENCE.

This warranty applies to units sold in the United States. Any units sold elsewhere are warranted by the affiliated marketing company of Thermo NESLAB Instruments, Inc. This warranty and all matters arising pursuant to it shall be governed by the law of the State of New Hampshire, United States. All legal actions brought in relation hereto shall be filed in the appropriate state or federal courts in New Hampshire, unless waived by Thermo NESLAB.