



Advanced Test Equipment Corp.
www.atecorp.com 800-404-ATEC (2832)



V60 Series Electrical Safety Testers



Operating Manual

For all Models V60, V61, and V63

9880A Via Pasar, San Diego CA 92126 USA

V: (858)689-2755

F: (858)689-2760

Web: www.vitre.com

E-mail: info@vitrek.com

Vitrek V60 Series – Electrical Safety Tester USER MANUAL

Vitrek V60 Series – Electrical Safety Tester USER MANUAL

WARNING

Vitrek Corporation, its representatives, vendors, and distributors assume no liability for the operation of this instrument in an unsafe manner. This instrument generates and delivers hazardous voltages (up to 5KVAC / 6KVDC). Always be extremely careful when using this instrument or any high voltage device. Read this manual completely and observe operating precautions in section three before operating the instrument.

Limited Warranty

The standard warranty period for this instrument is one year from date of shipment. Please refer to your invoice or shipping documents to determine appropriate warranty dates. Vitrek warrants to the original purchaser that this product will be free from defects in material and workmanship under normal use throughout the warranty period, provided that such defects are not determined by Vitrek to have been caused by abuse, misuse, alteration, improper installation, neglect or adverse environmental conditions. Vitrek Corporation's liability under this warranty is limited solely to the repair or replacement of this instrument during the warranty period, provided it is returned to the factory freight prepaid with a return authorization number.

No other warranty is expressed or implied. Vitrek Corporation is not liable for incidental, consequential, direct or indirect damages nor for costs, losses or expenses of any kind. A return authorization number must be obtained directly from the factory for warranty repairs. No liability will be accepted if returned without factory authorization number.

Technical Support

After reading this manual, if you have any questions or need technical assistance, please contact Vitrek customer support at:

Email: info@vitrek.com Vitrek Corporation
Fax: (858)689-2760 9880A Via Pasar
Voice: (858)689-2755 San Diego, CA 92126 USA

Extended Three Year Warranty Program

To qualify your instrument for an extended three-year warranty period you must:

1. Register your unit within 30 days from receipt by faxing or emailing the following data

Vitrek Model no. & S/N	
Contact Name	
Company / Organization	
Street Address	
City, State, Zip Code	
Contact Email Address	
Contact Phone Number	

2. Contact the factory for a reference number to return your unit to the factory for annual calibration and re-certification prior to the expiration of the initial cal due date. Upon receipt of your PO number for the calibration fee, the warranty will be extended for an additional year (up to a maximum of three years total warranty.)

TABLE OF CONTENTS	PAGE
1. INTRODUCTION to V60 SERIES.....	3
1-1. Description.....	3
1-2. Features.....	4
2. SPECIFICATIONS.....	4
3. PRECAUTIONS BEFORE OPERATION.....	6
3-1. Unpacking the Instrument.....	6
3-2. Safety Notice.....	6
3-3. Environment.....	7
4. PANEL INTRODUCTION.....	8
4-1. Front Panel.....	8
4-2. Rear Panel.....	9
5. OPERATING INSTRUCTIONS.....	10
5-1. Main LCD Display.....	10
5-2. Preparing the EST for Use.....	11
5-3. Structure of Stored Test Steps.....	17
5-4. Menu Parameter Setup & Operation.....	18
5-5. Remote Interface Operation.....	21
6. MEASUREMENT CONNECTIONS.....	22
7. PROGRAMMING.....	24
7-1. Introduction.....	24
7-2. Connecting the V60 via the GPIB interface.....	24
7-3. Connecting the V60 via the RS232 interface.....	26
7-4. Input and Output Queue.....	27
7-5. Commands and Syntax.....	27
7-6. Details of Command Reference.....	35
7-7. Status and Error Reporting.....	51
8. TROUBLE SHOOTING & MAINTENANCE.....	56
8-1. Fuse Rating and Type.....	56
8-2. Cleaning.....	57
8-3. Trouble Shooting.....	57
8-4. V60 Series Failure Indication.....	57
8-5. V60 Series Cal Procedure.....	58

SAFETY TERMS AND SYMBOLS

These terms may appear in this manual or on the product:



WARNING. Warning statements identify conditions or practices that could result in injury or loss of life.



CAUTION. Caution statements identify conditions or practices that could result in damage to this product or other property.

The following symbols may appear in this manual or on the product:



DANGER
High Voltage



ATTENTION
Refer to Manual



Protective
Conductor
Terminal



Ground
Terminal

1. V60 SERIES PRODUCT INTRODUCTION

Our goal at Vitrek is 100% customer satisfaction with both our products and our people. Please feel free to contact us if we can be of help with application or technical assistance, repair or calibration services accessories or spare parts.

Vitrek Corporation
9880A Via Pasar
San Diego, CA 92126 USA

Phone: (858)689-2755 Fax: (858)689-2760 E-mail: info@vitrek.com

1-1. Description

The Vitrek V60 Series Electrical Safety Testers comply with the requirement for electrical equipment and appliance control ordinances as defined by UL, CSA, JIS, BS and many other international standards. The testers are ideal for voltage withstand (Hipot) testing on a wide variety of electrical equipment and components. The Vitrek V60 series is a family of four automatic voltage withstand testers. The functions they provide include AC Hipot, DC Hipot, Insulation Resistance plus continuity.

Function Model	AC	DC	IR
V60	X		
V61	X	X	
V62	X		X
V63	X	X	X

1-2. Features

The V60 series electrical safety testers offer many outstanding features:

- 1) **No load setup of trip current and output voltage.** A safe way to setup the trip current and output voltage is without the high voltage being activated.
- 2) **A large 24x2 character LCD with adjustable LED back light.**
Provides a clear display showing test parameters including: group, step, mode, status, output voltage, trip current, and test time.
- 3) **Easy and quick setup via the front panel.** A user-friendly interface provides user with an easy and quick way to set all parameters.
- 4) **Electronic ramping and testing.** Digital controlled ramping time and testing time.
- 5) **Line and load regulation.** Linear amplifier with feedback-control, maintains output voltage regardless of the variation of load.
- 6) **Selectable output frequency.** 50/60 Hz is selectable by utility setup.
- 7) **Adjustable ARC detects level.** ARC detect level is selected by utility setup.
- 8) **Storage of up to 10 groups, 16 steps for each group.** A total of 10 groups provide the operator with the capability of testing different products. Each group includes 16 steps.
- 9) **Manual output voltage adjustment mode.** With a special test mode on the MAN group, the operator is able to adjust the output voltage during testing.
- 10) **Flashing high voltage indicator.** A flashing red LED indicates danger when high voltage output is activated.
- 11) **PLC remote control.** The 9-pin interface provides inputs (START, RESET) and outputs (TEST, PASS, FAIL).
- 12) **Data lock function.** Front panel can be locked or unlocked by utility setup.
- 13) **Ground Check function.** Check the continuity of earth ground in the power inlet before testing.
- 14) **Scanner Interface**
A pair of Scanner test with 96 channels.
- 15) **RS-232 and GPIB Interface**
The RS-232 and GPIB interface enables remote control operation and signal processing via a PC.

2. 2. VITREK V60 SERIES SAFETY TESTER SPECIFICATIONS

1) AC Hi-Pot Specifications:

Voltage Range	0.100~5.000Kv
Voltage Step	5V/step
Voltage Regulation (line & load)	1% + 5V
Voltage Accuracy	1% of reading +10V
Current Sourcing *	30~40Ma(above 500V, maximum test time: 180 sec) 0.10~29.99Ma(above 500V, continuous test) 0.10~10Ma(below 500V, continuous test)
Current Limit	0.10~40Ma, 0.02Ma/step
Current Accuracy	1% of reading + 50M a

2) DC Hi-Pot Specifications (V61, V63 only):

Voltage Range	0.100~6.000kV
Voltage Step	5V/step
Voltage Regulation (line & load)	1% + 5V
Voltage Accuracy	1% of reading +10V
Current Sourcing *	0.10~10.00mA(above 500V, continuous test) 0.10~2mA(below 500V, continuous test)
Current Limit	0.10~10mA, 0.01mA/step
Current Accuracy	1% of reading + 50μ A

3) Insulation Resistance Specifications (V62, V63 only):

DC Voltage	50V/100V/500V/1000V
Resistance Accuracy	50V/100V: 1~50MΩ : 5% of reading 51~200MΩ : 10% of reading 201~1990MΩ : 20% of reading 500V/1000V: 1~500MΩ : 5% of reading 501~2000MΩ : 10% of reading 2001~9999MΩ : 20% of reading

4) Continuity Specifications

Test Current	100mA
Resistance Range	0.001 to 1.500Ω
Resistance Accuracy	±0.075Ω

5) Ramp Time and Test Time

AC Hi-Pot Ramp/Test time	000.0~999.9s
DC Hi-Pot Ramp/Test time	000.0~999.9s
Insulation Resistance Time	001.0~999.9s
Ground Bond Test Time	000.0~999.9s

6) ARC Detect

Detect Current	40 level (1~40mA)
----------------	-------------------

Vitrek V60 Series – Electrical Safety Tester USER MANUAL

7) Storage

Groups	10
Steps	16

8) Interface

RS-232	Standard
GPIB	Option

9) PLC Control

D-sub 9 pins female	Standard
---------------------	----------

10) Scanner Interface

D-sub 9 pins female	Standard
---------------------	----------

11) General

Power Source	AC100V, 120V, 220V, 230V±10% 50/60Hz
Operation Environment	Indoor use, altitude up to 2000m. Ambient Temperature 0°C to 40°C. Relative Humidity 80% (Maximum). Installation category II Pollution Degree 2
Storage temperature & Humidity	-10°C to 70°C. 70% (Maximum).
Accessories	TL-20-60 × 1 Instruction manual × 1, Power Cord x 1
Dimension	446(L) × 330(W) × 149(H) (m/m)
Weigh	Approx. 14.9 kgs, 35lbs

The main purpose provided by the series of instruments is for Puncture Testing. The specification is not for continuous test. The temperature of heat sink is monitored. The test procedure will stop if the heat sink is too hot. Please refer to Figure 2-1.

Stop the instrument for 10 minutes when continuously proceeding 30~40mA withstanding test for one hour.

GENERAL SPECIFICATIONS:

Test Database: 10 Test Sequences with up to 16 steps per test sequence

Front Panel Lockout: Prevents database edit while in lockout mode

Arc Detect: 10 level trip select

Remote Interface: Fully interactive RS232 standard, GPIB optional, standard 9-pin D-sub connector with Outputs of Testing, Pass, Fail and inputs of Start, Reset. Output isolation is 400V with 130mA Continuous load current.

Timer Accuracy: 0.10% ± 50mS

Power Source: AC100V, 120V, 220V, 230V (±10% 50/60Hz), 250W max

Operating Environment: Indoor use, Altitude up to 6500ft (2000m). Installation Category II. Pollution Degree 2

Operating Temperature: 0°C to 40°C, 80% RH max.

Storage Temperature: -10°C to 70°C, 70% RH max

Dimension: 17.6”L x 13”W x 5.9”H, 446(L) x 330(W) x 149(H) mm

Weight: 30 lbs (14kg) net, 34 lbs (16 kg) ship

Vitretek V60 Series – Electrical Safety Tester USER MANUAL

Accessories: NIST certification, TL-20-60 Test Leads, Instruction Manual and power cord

Accuracy: Stated specifications apply for 1 year at 23 °C ± 5 °C

Calibration: Certificate of calibration, traceable to NIST provided

Compliance: CE mark certified to EN61010 and EMC directives EN50081-1 & EN50082-2

QuickTest™ Software Option QT-2: Bundled test automation software, with PC GPIB interface and cable. It has an easy to load graphical test sequence development and operating environment. Provides time/date, operator, test parameters, and test results for review, printout or export to database program.

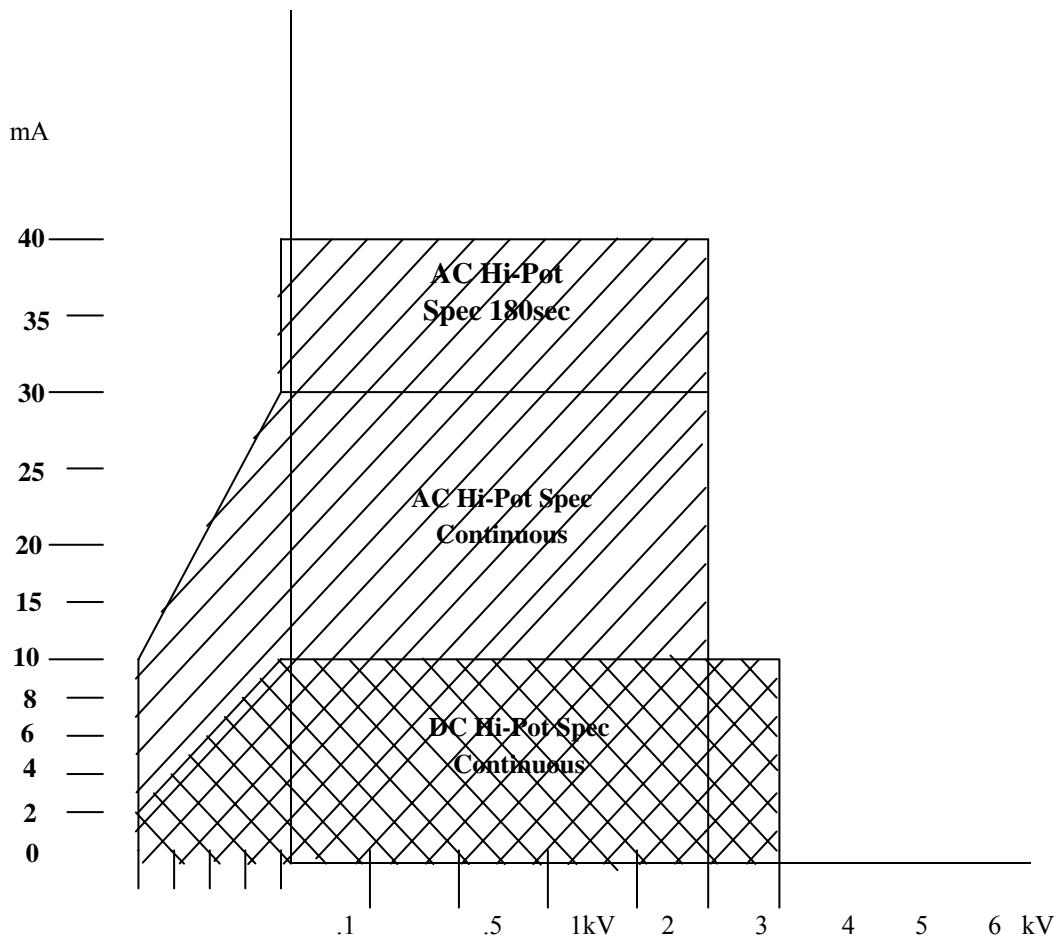

Figure 2-1

3. PRECAUTIONS BEFORE OPERATION

3-1. Unpacking the instrument

The product has been fully inspected and tested before shipping from the factory. Upon receiving the instrument, please unpack and inspect it for any damage that may have occurred during transportation. If any sign of damage is found, notify the carrier and Vitrek or your distributor immediately.

3-2. Safety Notice

Work Place Safety

The work place must be isolated from routine traffic and when high voltage testing is in process, a warning signal should be provided.

Checking the Line Voltage

The instrument can be connected to any kind of line voltage shown in the table below. Before connecting the power plug to an AC line outlet, make sure the voltage selector on the rear panel is set to the correct position corresponding to the line voltage. CAUTION: Damage to the instrument may occur if it is connected to the wrong AC line voltage.



WARNING. To avoid electrical shock the power cord protective grounding conductor must be connected to ground.

When line voltage is changed, install the required fuses shown as below:

Line voltage	Range	Fuse	Line voltage	Range	Fuse
100V	90-110V	T 4.0A	220V	198-242V	T 4.0A
120V	108-132V	250V	230V	207-250V	250V



WARNING. To avoid personal injury, disconnect the power cord before removing the fuse holder.

Operator's Precaution

- (1) Because of the extreme high output voltage and current of the breakdown tester, only a qualified person should operate the tester in order to avoid fatal electric shock.
- (2) On-the-job training is required for the operator to use the tester efficiently and safely.
- (3) The operator should be prohibited from wearing metal jewelry, etc in order to avoid an electrical shock.
- (4) A person with a heart condition or who wears a pacemaker must not operate the tester.

Safe, Secure Testing

The earth ground contact of the power cord must be properly connected in accordance with instructions. The return lead must be connected to the tested object first before high voltage testing. Do not handle the

Vitrek V60 Series – Electrical Safety Tester USER MANUAL

alligator test leads while high voltage is applied. Also, when using the optional HV probe do not touch the exposed conductive tip of the test probe during testing. Provide full control the power supplied to the tester by means of a carefully placed on/off switch or remote power control device.



WARNING: During testing, do not touch the test object or any other connected objects

3-3. Environment

The normal ambient temperature range of this instrument is from 0° to 40°C (32° to 104°F). Operation of the instrument above this specific temperature range may cause damage to the circuits.

Do not use the instrument in a place where a strong magnetic or electric field exists, as they may distort the measurements.

4. PANEL INTRODUCTION

4-1. Front Panel

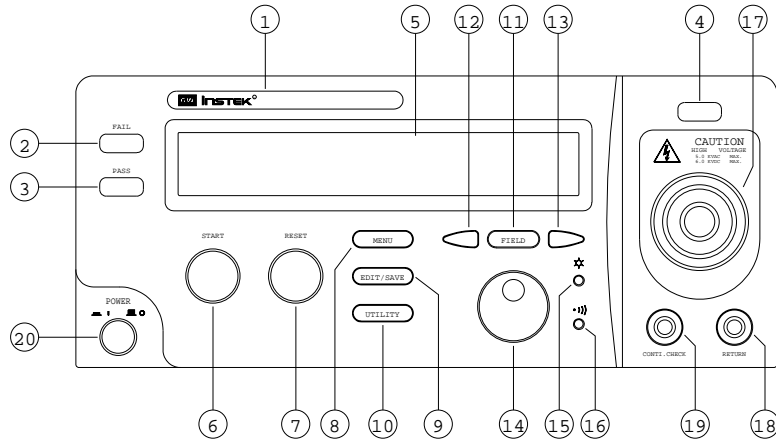

1	Model Number	Model number and description
2	FAIL Indicator LED	The red LED indicates failure of test procedure
3	PASS Indicator LED	The green LED indicates pass of test procedure
4	CAUTION Indicator LED	During test the red LED will flash to indicate danger.
5	Main Display LCD	The LCD displays all message about test procedure
6	START Button	Press the green button to start a test procedure
7	RESET Button	Press the red button to reset/stop a test procedure
8	MENU Key	When you press the MENU key, the status becomes MENU and you can browse all groups.
9	EDIT/SAVE Key	When you press the EDIT/SAVE key, the status EDIT is active and you can edit this step or setup. Press the EDIT/SAVE key again will save this step or setup.
10	UTILITY Key	When you press the UTILITY key, the status UTILITY is active and you can view all the utility setups.
11	FIELD Key	When you edit the test step, press the FIELD key to change the active parameter of stop.
12	Left Arrow Key	Press the arrow key to adjust knob's resolution.
13	Right Arrow Key	Press the arrow key to adjust knob's resolution.
14	Knob	If status EDIT is active, turn the knob to increase or decrease the value of active parameter. If status MENU is active, turn the knob to increase or decrease active Step.
15	LCD Back light Adjustment	Turn the VR to adjust the LED back light of LCD.
16	Buzzer Volume Adjustment	Turn the VR to adjust the buzzer volume.
17	High Voltage Output Seat	High voltage output terminal.
18	RETURN Terminal	Test return terminal.
19	CONTI. CHECK Terminal	Continuity check output terminal.
20	Power Switch	Press the power switch to turn on the tester.

4-2. Rear Panel

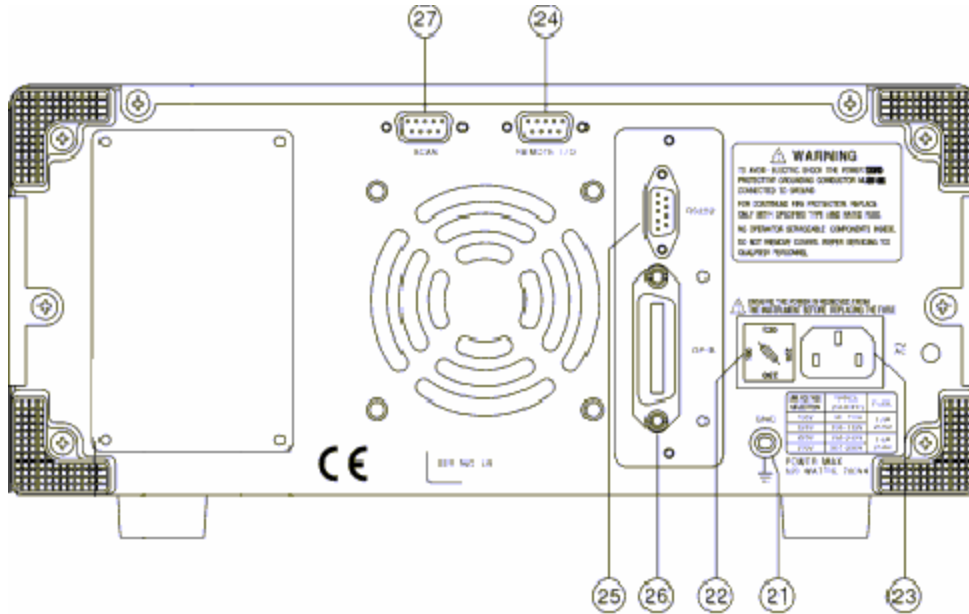

21	Ground Terminal	Connect Ground terminal to the earth ground.
22	Fuse Holder with Voltage Selector	To change AC source voltage, pull the fuse holder and rotate it to the proper value.
23	AC Inlet	Connect the AC power line to the inlet.
24	Remote I/O	The remote I/O performs all the functions of PLC control.
25	RS232 Terminal	D-SUB 9 pin connector, Input/Output connector for RS232.
26	GPIB Terminal	Blue 24 connector, Input/Output connector for IEE-488.
27	Scanner Interface	D-sub 9 pins female connector for scanner box.

5. OPERATING THE INSTRUMENT

5-1. Main Display LCD

Storage	Mode	Output Voltage/Current	Status
1 : 1	ACW	V = 5 . 0 0 0 k V	R E A D Y
I m A x = 0 1 . 0 0 m A		T E S T = 0 0 0 . 0 s	
Measurement Limit		Ramp/Test Time	

Table of Parameters

Storage	Group: There are a total of 10 groups, 6 steps for each group. The first number indicates the group while the second number indicates the step. Ex. 3:1 means the 1st step in group 3 is active.
Mode	The test mode of tester includes: ACW: AC Withstanding voltage test DCW: DC Withstanding voltage test I R : Insulation Resistance test Cont: Continuity check (The available modes vary by model.)
Output Voltage/Current	Output voltage or current for each step: AC: Output voltage (0.100~ 5.000 kV) DC: Output voltage (0.100~ 6.000 kV) IR: Output voltage (0.500kV or 1.000kV) Cont: Output current (0.100A)
Status	The status of tester includes: MENU: Browse and check steps of test. EDIT: Edit parameters SAVE: Save parameters UTIL: Browse and check system utility. READY: Ready for test TEST: Testing PASS: The result of test is pass FAIL: The result of test is fail STOP: Stop the test
Measurement Limit	Lower and upper limit of measurement: Imax/Imin: Current measurement limit (ACW & DCW) Rmax/Rmin: Resistance measurement limit (IR & Cont)
Ramp/Test Time	Ramp time and test time: AC: Ramp/Test (000.0~999.9 s) DC: Ramp/Test (000.0~999.9 s) IR: Test (000.0~999.9 s) Con: Test (000.0~999.9 s)

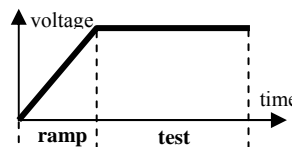

5-2. Preparing the V60 Series EST for Use

To view the Stored Steps

1. Press the **MENU** key to access test number field.

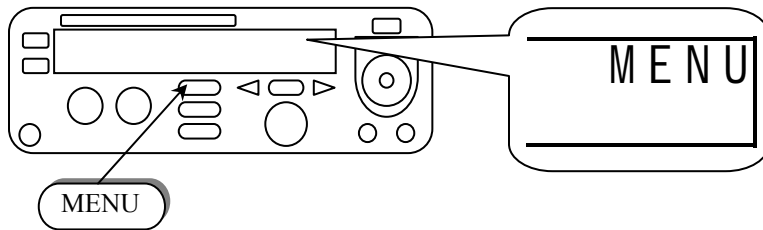

2. Use the left and right arrow keys to select group or step. Use the knob to change the active step.

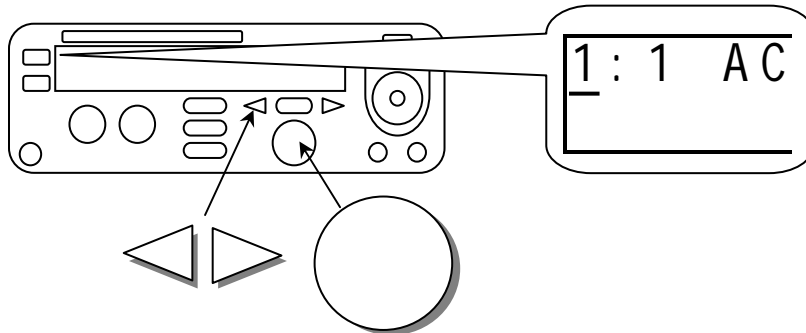

To Edit and Save the Stored Steps

1. Follow the above procedure “**To View the Stored Steps**” in order to select the desired step.
2. Press the **EDIT/SAVE** key to enter EDIT status.

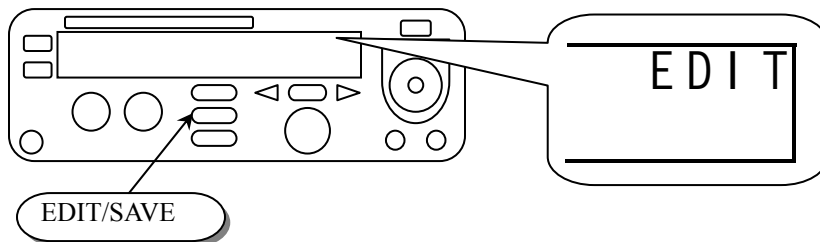

3. Use the knob to adjust the parameter. Use arrow keys to change the knob's resolution.

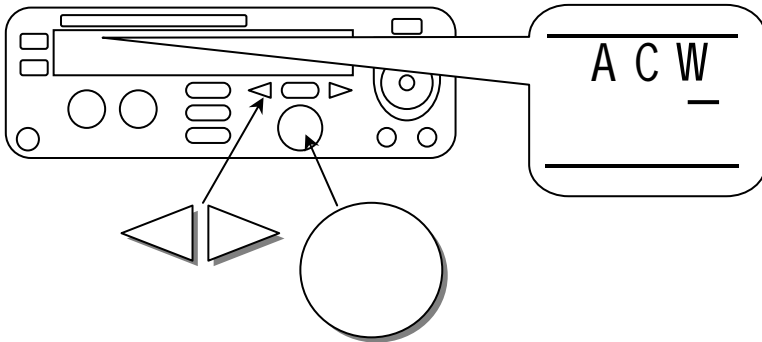

4. Use **FIELD** key to advance to the next parameter field.

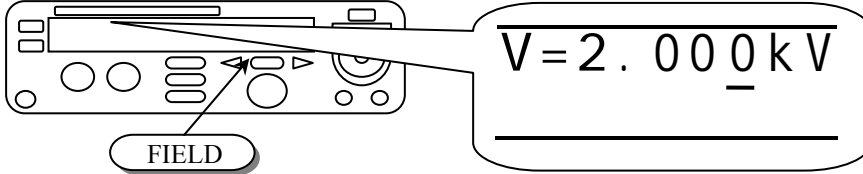

5. Repeat step 3 and 4 to adjust parameters.

6. After setting all parameters, press **EDIT/SAVE** to save the step. The status will become SAVE. After the step is saved, the status will return to EDIT.

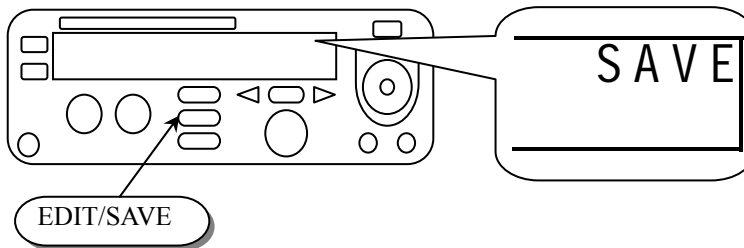

7. Repeat the procedure “**To View the Stored Steps**” to select another step.

To Begin a Group Test

1. Repeat the procedure “**To View the Stored Steps**” to select a step.
2. Press RESET button to enter status READY.

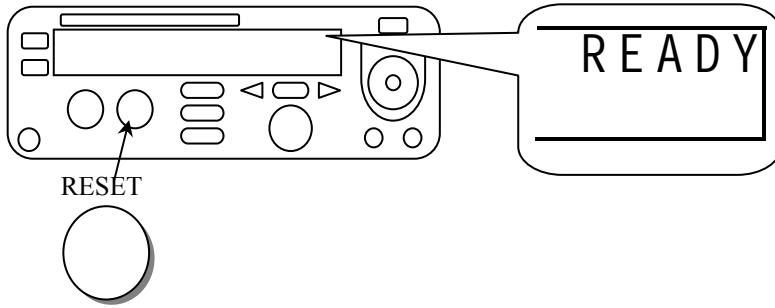

3. Make sure the test environment is safe.
4. Press START button to start the test while the status TEST is active and the CAUTION LED flashes.

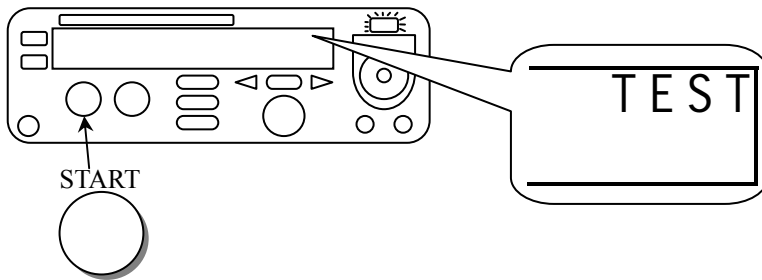

5. If you press RESET button the test will stop immediately.

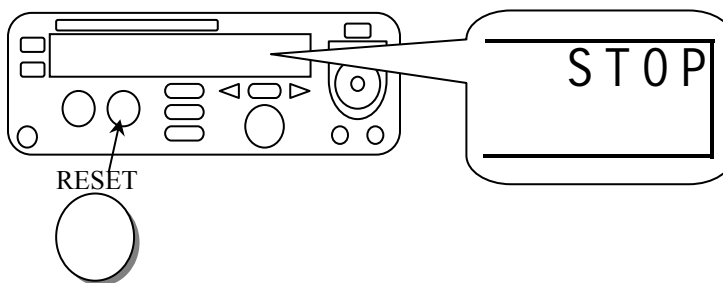

6. If the result is pass, the PASS LED will be active.

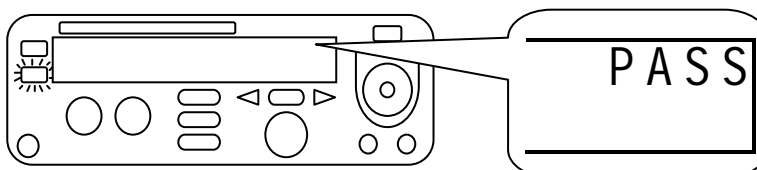

7. If the result is fail, the FAIL LED will be active and the buzzer will alarm the operator. To stop the alarm, press RESET button again.

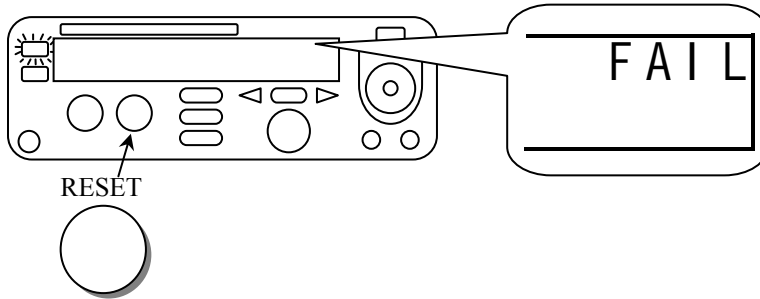

8. Use the knob to view the result of group step by step.

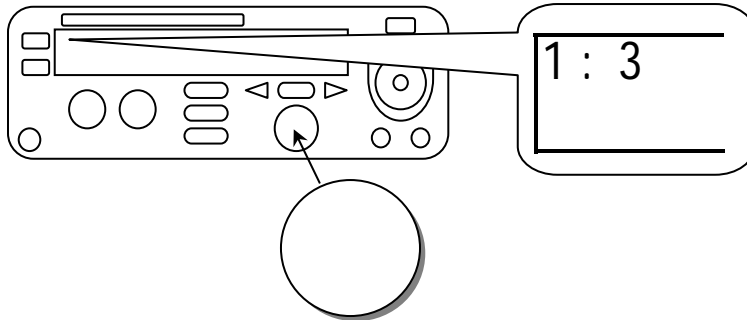

To View the System Utility

1. Press the **UTILITY** key to enter status UTIL.

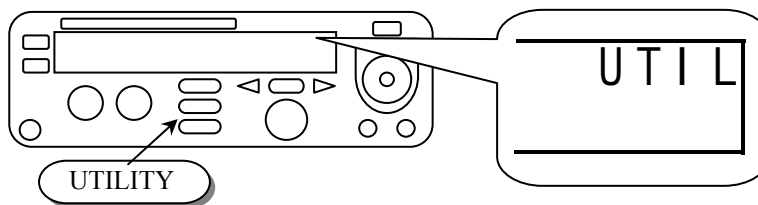

2. Use the knob or arrow keys to change the active parameter.

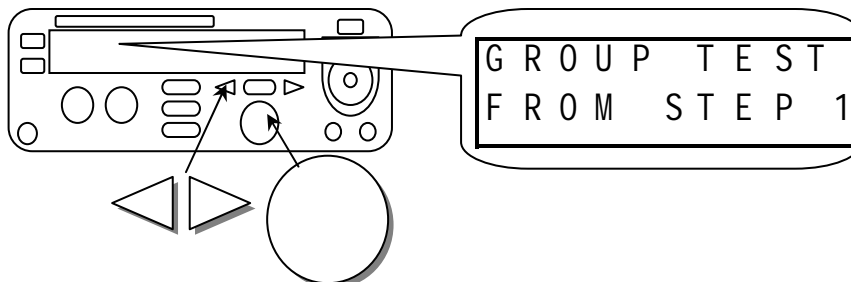

Vitrek V60 Series – Electrical Safety Tester USER MANUAL

Table of system utility:

Parameter	Option	Description
TEST MODE	From STEP 1	The group test procedure always begins from step 1 to end of group. (e.g. 3:1~3:6, 4:1~4:6)
	From the present step	The group test procedure always begins from the step selected to end of group. (e.g. 3:3~3:6, 4:3~4:6)
ARC MODE	DISABLE	Disable the function arc detection.
	ENABLE & STOP	Enable the arc detection and stop the test when arc is active.
	ENABLE & CONTINUE	Enable the arc detection and continue the test when arc is active.
ARC CURRENT*		Set the current level of arc detection.
AC FREQUENCY	50 Hz	Set the ac hipot output frequency to 50 Hz.
	60 Hz	Set the ac hipot output frequency to 60 Hz.
CONTROL MODE	MODE 1	Mode 1: Double click (Reset / Start)
	MODE 2	Mode 2: Press the start button directly.
	MODE 3	Mode 3: PLC remote enable
DATA LOCK	UNLOCKED	Accepts and saves all parameters of test step and utility.
	LOCKED	Will not change any parameters of test step and utility.
FAIL Setting	Stop	The operation will stop upon the failure occurred at any step of group test.
	Continue	The operation will not stop until all 16 group steps have been tested.
Interface	RS-232 Baud Rate	1200, 2400, 4800, 9600.
	GPIB Address	00~31
Conti. Calibration		Calibrates (zeroes) the resistance of test leads for the Continuity check.

* The arc detection circuit is tuned for high frequencies. It does not see any line frequency energy. Arcs are a wide band phenomenon and are not required for electrical safety testing, so it is safe to disable this feature. It is there primarily as a QC feature above and beyond the safety requirement. The safety spec is checking for electrical breakdown of the primary insulation. Breakdown is defined by UL as a sudden and uncontrolled flow of current. Since an arc tends to be a controlled flow of current it is not considered a breakdown.

Please note that the Utility menu is context sensitive—that is, the options available are contingent upon which test is currently ready to be run. For example, if you have an ACW test ready, you will have the Arc Mode and Current selections available to you, but not the IR Test Mode or Cont Zero Check selections. To set these, select either an IR or a Cont test, respectively. The Group Test, Test Control Mode, Data Lock, Interface, and Fail Setting options are available regardless of what test is selected. Refer to the following table for a complete listing of options

	GROUP TEST	ARC MODE	ARC CURRENT	AC FREQ	TEST CONTROL	DATA LOCK	IR MODE	Cnt ZERO	INTERFACE	FAIL SETTING
AC										
DC										
IR										
Cnt										

To Edit/Save the System Utility

1. Follow the above procedure “To View the System Utility “ to select a parameter.
2. Press the **EDIT/SAVE** key to enter EDIT mode.

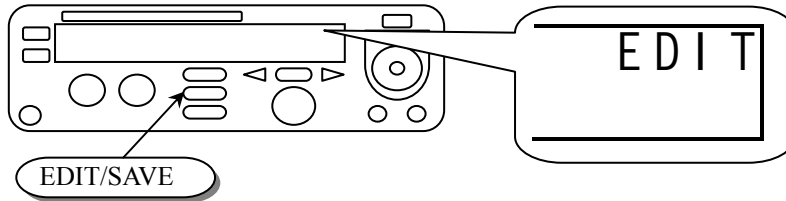

3. Use the knob to adjust the parameter. Use arrow keys to change the knob's resolution.

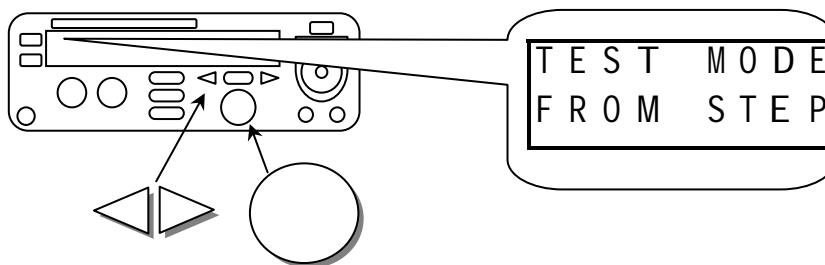

4. After setting the parameter, press **EDIT/SAVE** key in order to save the parameter. The unit will go into SAVE mode. After the parameter is saved, the unit will return to EDIT mode.

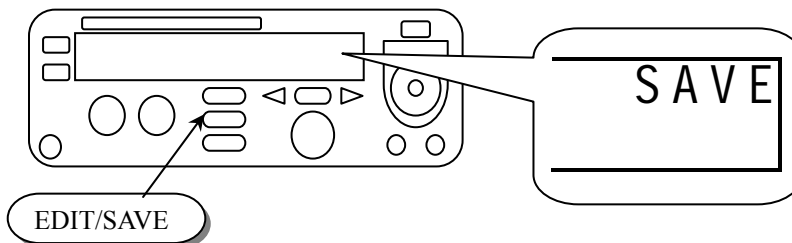

5. To exit edit mode, press the UTILITY button to select another parameter, or the MENU button to return to the test menu.
6. Repeat the procedure “**To View the System Utility**” to select another parameter.

5-3. Structure of Test Sequence Storage

The test sequence database of the EST consists of a total of 6 test sequences or groups (group 1 ~ group 6), with 6 steps (step 1 ~ step 6) for each group. In addition to these steps, there is another step “0:0” for manually controlled tests. The order of stored steps is Group: Step. The first number represents the Group number while the second represents the Step number.

	Group 0	Group 1	Group 2	Group 3	Group 4	Group 5	~	Group 9
Step 1	0:01	1:01	2:01	3:01	4:01	5:01	~	9:01
Step 2	0:02	1:02	2:02	3:02	4:02	5:02	~	9:02
Step 3	0:03	1:03	2:03	3:03	4:03	5:03	~	9:03
Step 4	0:04	1:04	2:04	3:04	4:04	5:04	~	9:04
↓	↓	↓	↓	↓	↓	↓		↓
Step 16	0:16	1:16	2:16	3:16	4:16	5:16	~	9:16

The special test group “MAN” contains another two types of tests: CAC and CDC. The function of CAC and CDC is the same as ACW and DCW, except that the user is able to manually adjust the output voltage with the knob during the test.

After each step has been tested, the tested status will be shown on the screen:

Step	1	2	3	4	5	6	7	8	9	0	1	2	3	4	5	6
Test	P	P	P	P	P	P	P	P	P	P	P	P	P	P	P	P

N: Empty

P: Pass

F: Fail

- Step 1: CH1
- Step 2: CH2
- Step 3: CH3
- Step 4: CH4
- Step 5: CH5
- Step 6: CH6
- Step 7: CH7
- Step 8: CH8
- Step 9: CH9
- Step 0: CH10
- Step 1: CH11
- Step 2: CH12
- Step 3: CH13
- Step 4: CH15
- Step 5: CH15
- Step 6: CH16

To view the detailed results of any individual step, simply rotate the knob to select the desired step.

5-4. Menu Parameter Setup

- **AC/DC Hipot - Voltage withstand test (ACW/DCW)**

Press MENU key to enter MENU mode then use knob and arrow keys to select a step.

Press EDIT/SAVE key to enter EDIT mode. The cursor stays at the “test mode” field. Use knob to select desired test ACW (DCW).

Functionality of FIELD key:

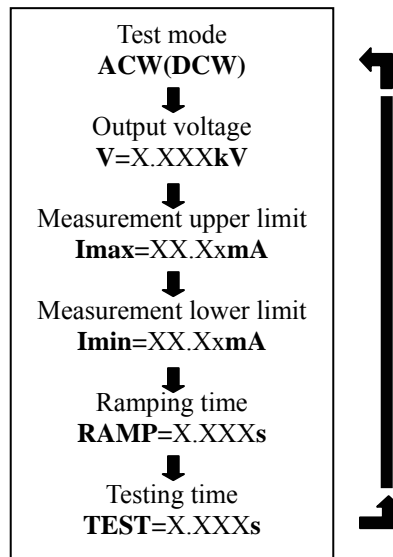

Press FIELD key to edit the next field “output voltage”. Use the knob to adjust the desired output voltage while using the arrow keys to adjust the knob’s resolution (0.100~ 5.000 kV for ACW, 0.100~ 6.000 kV for DCW).

Press FIELD key again to enter the next field “measurement upper limit”. Use the knob to adjust the desired upper limit of leakage current while using the arrow keys to adjust the knob’s resolution (0.10~15mA for ACW, 0.10~7.5mA for DCW).

Press FIELD key again to enter the next field “measurement lower limit”. Use the knob to adjust the desired lower limit of leakage current while using the arrow keys to adjust the knob’s resolution (0.10~15mA for ACW, 0.10~7.5mA for DCW).

Press FIELD key again to enter the next field “ramping time”. Use the knob to adjust the desired ramping time while using the arrow keys to adjust the knob’s resolution (0~999.9s).

Press FIELD key again to enter the next field “testing time”. Use the knob to adjust the desired testing time while using the arrow keys to adjust the knob’s resolution (0~999.9s).

Press FIELD key again to return to the first field “test mode” again.

Press EDIT/SAVE key to save all the parameters.

- **Continuous AC/DC withstanding voltage test (CAC/CDC)**

The CAC/CDC test is available only on step “MAN”. Like the traditional hipot tester, you can use the knob and arrow keys to adjust output voltage during the test.

All the parameters of CAC/CDC are the same as ACW/DCW, except the testing time. The testing of CAC/CDC is not limited.

- **Insulation Resistance test (IR)**

Press MENU key to enter status MENU then use the knob and Arrow keys to select a step.

Press EDIT/SAVE key to enter status EDIT. Now the cursor stays at the “test mode” field. Use the knob to select IR mode.

Functionality of FIELD key:

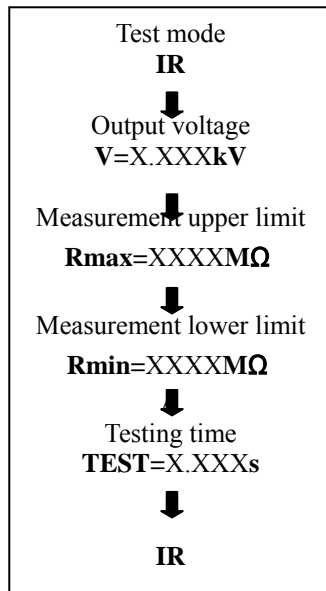

Press FIELD key to edit the next field “output voltage”. Use the knob to adjust the desired output voltage (500V/1000V).

Press FIELD key again to enter the next field “measurement upper limit”. Use the knob to adjust the desired upper limit of resistance while using the arrow keys to adjust the knob’s resolution (0~9999MΩ).

If no upper resistance limit is desired, enter 0.000 and the upper resistance limit will be ignored.

Press FIELD key again to enter the next field “measurement lower limit”. Use the knob to adjust the desired lower limit of resistance while using the arrow keys to adjust the knob’s resolution (0~9999MΩ).

Press FIELD key again to enter the next field “testing time”. Use the knob to adjust the desired testing time while using the arrow keys to adjust the knob’s resolution

Press FIELD key again to return to the first field “test mode” again.

Press EDIT/SAVE key to save all the parameters.

- **Continuity Check (Cont.)**

Press MENU key to enter status MENU then use the knob and arrow keys to select a step.

Press EDIT/SAVE key to enter status EDIT. Now the cursor stays at the “test mode” field. Use the knob to select mode Cnt. The output current is fixed at 0.100A.

Functionality of FIELD key:

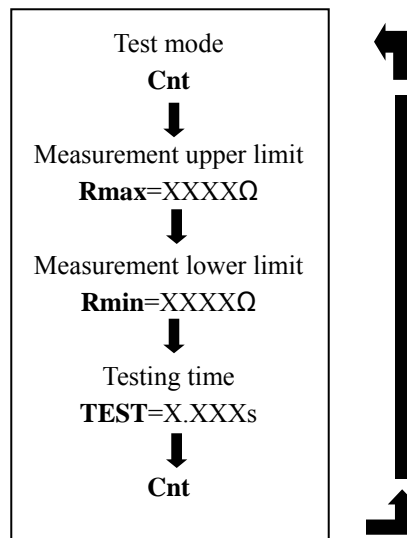

Press FIELD key to enter the next field “measurement upper limit”. Use the knob to adjust the desired upper limit of resistance while using the arrow keys to adjust the knob’s resolution (0~1.200).

Press FIELD key again to enter the next field “testing time”. Use the knob to adjust the desired testing time while using the arrow keys to adjust the knob’s resolution (0~999.9s).

Press FIELD key again to return to the first field “test mode” again.

Press EDIT/SAVE key to save all the parameters.

5-5 Remote Interface Operation

To prepare the unit for control via the remote interface, press the UTILITY key and dial up the TEST CONTROL MODE using the knob. Press the SAVE/EDIT key to edit the field and use the knob to select MODE 3: PLC ENABLE, then press SAVE/EDIT to save the setting and press MENU to exit the utility mode. The unit is now configured for remote operation.

The remote interface provides two inputs (START and RESET) and three outputs (TESTING, PASS and FAIL). The I/O connector is a DB9 FM. Output contacts are rated at 400V/ 1.3 amps maximum.

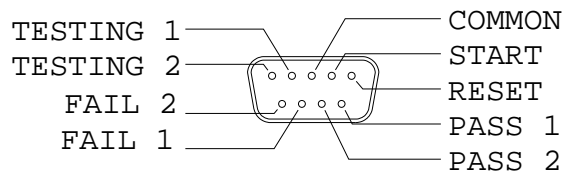

- RESET: Connecting “RESET”(pin 1) to “COMMON”(pin 3) will reset or interrupt this machine (the same function as the RESET button on the front panel). A reset is required to clear the pass/fail status and place the tester in the ready mode.
- START: In status READY, connecting “TEST”(pin 2) to “COMMON”(pin 3) will start the test procedure (the same functionality as the START button in the front panel).
- TESTING 1, 2 While testing, the “TESTING” lines will be shorted and will remain shorted until the pass/fail contacts are set.
- PASS 1, 2 If the result of the test is “pass”, the “PASS 1” and “PASS 2”(pins 6 & 7) will be shorted.
- FAIL 1, 2 If the result of the test is “fail”, the “FAIL 1 and “FAIL 2”(pins 8 & 9) will be shorted. The pass/fail results will remain valid until the reset is activated.

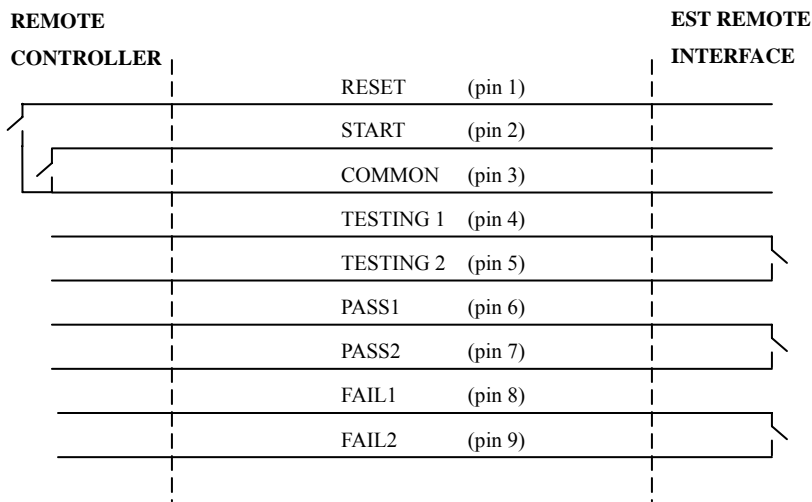

6. MEASUREMENT CONNECTIONS



- 1. High Voltage Output Terminal.** This large HV connector with a red circle around it is the output terminal for all HV tests (ACW, DCW and IR). For typical electrical safety testing, this terminal connects to both the line and neutral power pins of the device under test (DUT). For ease of connection Vitrek offers the TL-IEC-60 shown above, which plugs directly into an IEC 320 style power inlet. For devices using a NEMA 5-15 (North American) power plug the available TL-115-60 provides for quick and convenient connection. CAUTION: The HV terminal is capable of delivering up to 5kVAC or 6kVDC. Avoid contact with the terminal, test leads and the DUT when high voltage is present on this terminal.
- 2. Return Terminal.** The return terminal is the reference terminal for leakage current measurements and is also one of the two terminals used in making a continuity (low resistance) measurement. This terminal typically connects to the earth ground pin of the DUT. Inside the TL-115-60 and the TL-IEC-60 this terminal is connected to the earth socket of the test adapter.
- 3. Conti. Check.** This is the other of the two terminals used in making a continuity (low resistance) measurement. The V60 Series EST's always measure continuity between the "Conti. Check" and the "Return" terminals.

4. **Device Under Test (DUT).** A power supply shown here, represents a typical DUT. The connection to the DUT power inlet is made here by way of the optional TL-IEC-60.
5. **DUT Chassis.** The Conti Check terminal connects directly to the DUT chassis via the standard alligator test lead.

Typical Electrical Safety Test Connection Diagram

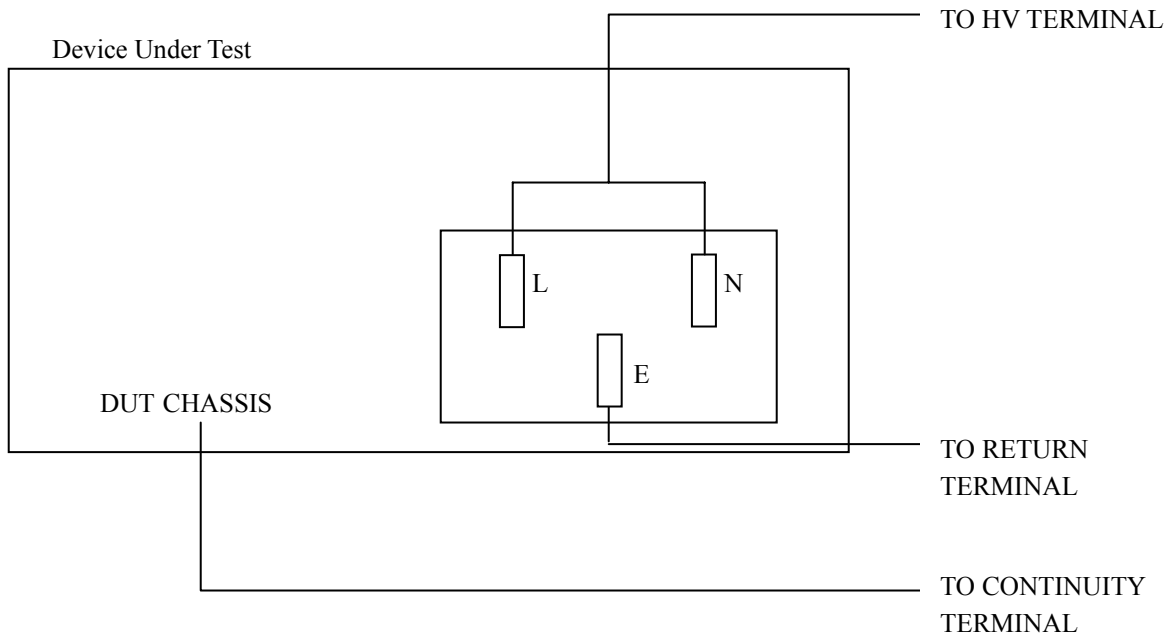

7. PROGRAMMING

7-1. Introduction

The Vitrek V60 Series Electrical Safety Tester (EST) is a fully interactive automatic measurement system. Communication between the V60 Series and host computers is easily accomplished. The V60 Series' standard RS232 interface or optional GPIB interface provide the capability to download and run a custom test sequence, as well as, monitor the status of the test and retrieve results and actual readings.

Interface selection and setup:

The GPIB address and RS232 baud rate can be changed in normal operation condition. Press [UTILITY] key and knob switch or arrow keys on the front panel, in which the last transmitting interface settings will be displayed. Select interface and press [EDIT/SAVE], then select the baud rate (or GPIB address) and press [FIELD] to confirm the setting. Finally, press [EDIT/SAVE] to store the setup.

7-2. Connecting the V60 Series via GPIB Interface

The GPIB interface capabilities:

The GPIB interface of the V60 Series corresponds to the standard of IEEE488.1-1987, IEEE488.2-1992 and SCPI-1994. The GPIB interface functions are listed as follows:

SH1 (Source Handshake):	The EST can transmit multilane messages across the GPIB.
AH1 (Acceptor Handshake):	The EST can receive multilane messages across the GPIB.
T6 (Talker):	Talker interface function includes basic talker, serial poll, and unaddress if MLA capabilities, without talk only mode function.
L4 (Listener):	The EST becomes a listener when the controller sends its listen address with the ATN (attention) line asserted. The power supply does not have listen only capability.
SR1 (Service Request):	The EST asserts the SRQ (Service request) line to notify the controller when it requires service.
RL1 (Remote/Local):	The EST responds to both the GTL (Go to Local) and LLO(Local Lock Out) interface messages.
PP0 (Parallel Poll):	The EST has no Parallel Poll interface function.
DC1 (Device Clear):	The EST has a Device clear capability that returns the device to the power on status.
DT0 (Device Trigger):	The EST has no Device Trigger interface function.
C0 (Controller):	The EST cannot control other devices.

Notes for GPIB installation:

When the V60 Series is set up with a GPIB system, please check the following things:

- Only a maximum of 15 devices can be connected to a single GPIB bus.
- Do not use more than 20m of cable to connect devices to a bus.
- Connect one device for every 2m of cable used.
- Each device on the bus needs a unique device address. No two devices can share the same device address.
- Turn on at least two-thirds of the devices on the GPIB system while using the system.

- Do not use loop or parallel structure for the topology of GPIB system.

Computer's Connection

A personal computer with a GPIB card is the essential facilities in order to operate the V60 Series via GPIB interface. The connections between power supply and computer are following:

1. Connect one end of a GPIB cable to the computer.
2. Connect the other end of the GPIB cable to the GPIB port on the V60 Series.
3. Turn on the V60 Series.
4. Turn on the computer.

The GPIB connection testing:

If you want to test whether the GPIB connection is working or not, you can send a GPIB command from computer. For instance, the query command

*idn?

should return the Manufacturer, model number, serial number and firmware version in the following format:

Vitrek, V60 Series, FW1.00

If you do not receive a proper response from the EST, please check if the power is on, the GPIB address is correct, and all cable connections are active.

7-3. Connecting the V60 Series via the RS232 Interface

The RS232 interface capabilities:

The RS232 interface provides a point-to-point connection between two items of equipment such as a computer and the EST. There are some parameters you need to set on the both sides. Once you have set these parameters, you can control the power supply through the RS232 interface.

- Baud rate: You can set rates of 1200, 2400, 4800 or 9600 baud.
- Parity bit: none.
- Data bit: 8 bits.
- Stop bit: 1 stop bit.
- Data flow control: none.

Notes for RS232 installation:

The EST is a DTE device with a 9-pin D-type shell RS232 connector located on the rear panel. Figure 1 shows the equipment of 9-pin connector (male) with its pin number assignments. Figure 2 shows the wiring configuration for DB9 to DB9. When the V60 Series is set up with a RS232 interface, please check the following points:

- Do not connect the output line of one DTE device to the output line of the other.
- Many devices require a constant high signal on one or more input pins.
- Ensure that the signal ground of the equipment is connected to the signal ground of the external device.
- Ensure that the chassis ground of the equipment is connected to the chassis ground of the external device.
- Do not use more than 15m of cable to connect devices to a PC.
- Ensure the same baud rate is used on the device as the one used on PC terminal.
- Ensure the connector for the both side of cable and the internal connected line are met the demand of the instrument.

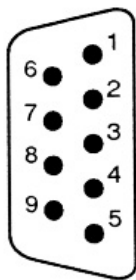

1. No connection
2. Receive Data (RxD) (input)
3. Transmit Data (TxD) (output)
4. No connection
5. Signal Ground (GND)
6. No connection
7. No connection
8. No connection
9. No connection

Pin assignments of the RS232 connector on the rear panel for DB-9-D

Wiring configurations for DB9 to DB9:

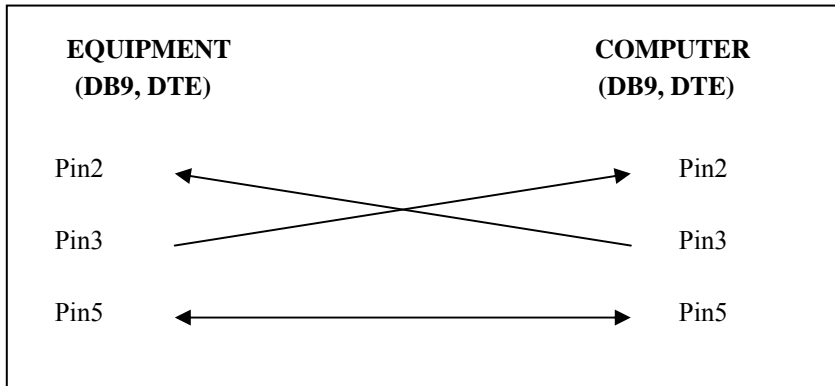

Computer's Connection

A personal computer with a COM port is the essential facilities in order to operate the V60 Series via RS232 interface. The connections between EST and computer are as follows:

1. Connect one end of a RS232 cable to the computer.
2. Connect the other end of the cable to the RS232 port on the V60 Series.
3. Turn on the V60 Series.
4. Turn on the computer.

The RS232 connection testing:

If you want to test whether the RS232 connection is working or not, you can send a command from computer. For instance, using a terminal program send the query command

*idn?

should return the Manufacturer, model number, serial number and firmware version in the following format:

GW.Inc, GPI-745,FW1.00

If you do not receive a proper response from the EST, please check if the power is on, the RS232 baud rate are the same on both sides, and all cable connections are active.

7-4. Input and Output Queue

The design of 128 bytes input queue and 128 bytes output queue for storing the pending commands or return messages is to prevent the transmitted commands of remote control and return messages from missing. As the maximum stored capacity for Error/Event Queue is 20 groups of messages, it should be noted that input data exceeding the capacity by using these buffers would cause data missing.

7-5. Commands and Syntax

The GPIB commands of the V60 Series are compatible with IEEE-488.2 and SCPI standards

SCPI (Standard Commands for Programmable Instruments) is a standard that created by an international consortium of the major test and measurement equipment manufacturers. The IEEE-488.2

syntax has been adopted by SCPI to provide common commands for the identical functions of different programmable instruments.

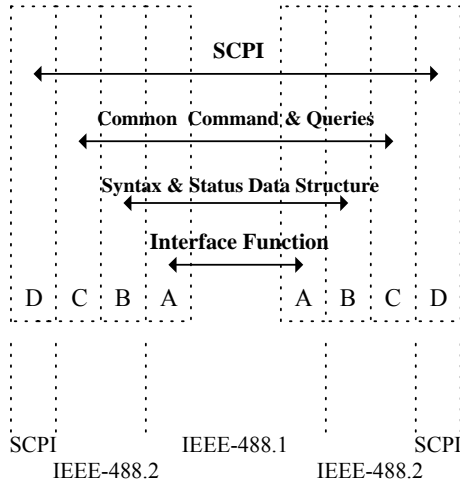

Relationship between IEEE-488.1, IEEE-488.2, and SCPI

As shown in the figure 3, the IEEE-488.1 standard locates at layer A, the layer A belongs to the protocol of interface function on the GPIB bus. The source handshake (SH), acceptor handshake (AH) and talker are included to this layer (10 interface functions totally).

At layer B, the syntax and data structure could be the essence of entire IEEE-488.2 standard. The syntax defines the function of message communication, which contain the <PROGRAM MESSAGE> (or simply “commands”) and <RESPONSE MESSAGE>. The two kinds of messages represent the syntax formation of device command and return value. The data structure is the constitution of status reporting, which IEEE-488.2 standard have been defined.

The common commands and queries are included to layer C. Commands and queries can be divided into two parts: mandatory and optional. Commands modify control settings or tell the instrument to perform a specific action. Queries cause the instrument to send data or status information back to the computer. A question mark at the end of a command identifies it as a query.

Layer D is interrelated with device information. Different devices have different functions. SCPI command sets belong to this layer.

Command Syntax

If you want to transfer any instructions to an instrument, and comply with SCPI, there are three basic elements must be included.

- Command header
- Parameter (if required)
- Message terminator or separator

Command Header

The command header has a hierarchical structure that can be represented by a command tree (Figure 4). The top level of the tree is the root level. A root node is located at the root level. A root node and one or more lower-level nodes form a header path to the last node called the leaf node.

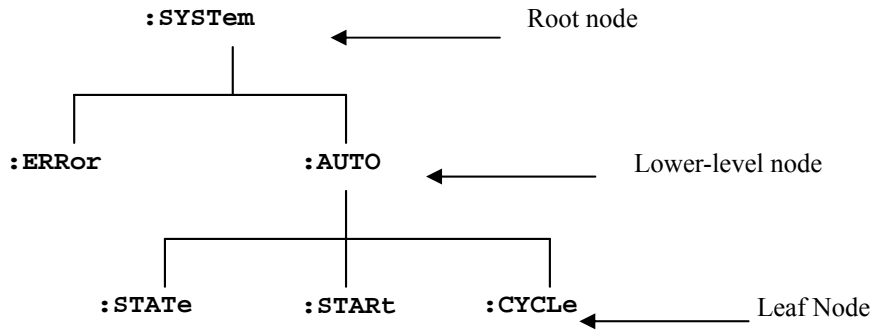

Figure 4: Tree hierarchy

The command header is configured by header path and leaf node. Figure 5 shows the command header for the leaf node indicated in Figure 4.

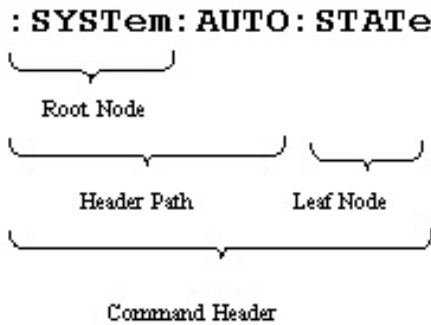

Figure 5 Command Header

Parameter

If the commands have parameters, the values have to be included. In this manual, when we expressed the syntax of the command, the <> symbols are used for enclosing the parameter type. For instance, the syntax of the command in Figure 6 includes the Boolean parameter type.

NOTE: Do not include the <, >, or / symbols when entering the actual value for a parameter.

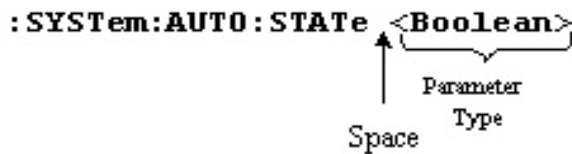

Figure 6 Command Header with Parameter

Table 1 defines the Boolean and other parameter types for the V60 Series.

Parameter Type	Description	Example
Boolean	Boolean numbers or values	0, 1
NR1	Integers	0, 1, 18
NR2	Decimal numbers	1.5, 3.141, 8.4
NR3	Floating point numbers	4.5E-1, 8.25E+1
String	Alphanumeric characters	“No error”

Table 1: Parameter Types for Syntax Descriptions

Message Terminator and Message Separator

I. GPIB message terminators

In accordance with IEEE 488.2 standard, any of the following message terminators are acceptable:

- LF[^]END Line feed code (hexadecimal 0A) with END message
- LF Line feed code
- <dab>[^]END Last data byte with END message

These terminators are compatible with most application programs. A semicolon separates one command from another when the commands appear on the same line.

II. RS232 message terminators

As there is no signal of end message on RS232 bus, therefore, use LF as message terminator. When a series of commands are sent to the instrument, it must add a LF to be a judgment for message terminator. As for query command, the return message of the instrument is also added a LF for PC to judge message terminator.

Entering Commands

The standards that govern the command set for the V60 Series allow for a certain amount of flexibility when you enter commands. For instance, you can abbreviate many commands or combine commands into one message that you send to the V60 Series. This flexibility, called friendly listening, saves programming time and makes the command set easier to remember and use.

Command Characters

The V60 Series are not sensitive to the case of command characters. You can enter commands in either uppercase or lowercase.

You can execute any command with white space characters. You must, however, use at least one space between the parameter and the command header

Abbreviating Commands

Most commands have a long form and a short form. The listing for each command in this section shows the abbreviations in uppercase. For instance, you can enter the query : ACWStanding: VOLTage 1.000 simply as : ACWStanding: VOLTage 1.000

Because the V60 Series hypothesis that a command starts from the root, you have the option of beginning the initial command header with a colon (:).

Combining Commands

You can use a semicolon (;) to combine commands. But continuously query command will cause message missing. For example

```
:GRO:STEP:ACWS:VOLT::CMAx?
```

If the command that follows the semicolon has a different header path from the root level, you must use a colon to force a return to the root level.

```
:ACC:CMIN 1.00::ACC:CMAx 2.00
```

If the command that follows the semicolon has the same header path, you may omit the colon and the path and state only the new leaf node. For example:

```
:ACC:CMIN 1.00;;ACC:CMAx 2.00
```

is equal to

```
:ACC:CMIN 1.00;;CMAx 2.00
```

You can combine commands and queries into the same message. Note, for example, the following combination:

```
:ACC:CMIN 1.00;CMIN?
```

Synopsis of Commands

The tables in this section summarize the command of the programmable power supply. These tables divide the commands into three functional classifications:

- **General Setting Commands:** control and query the settings of the power supply
- **Status Commands:** set and query the various registers and queues that make up the status and event structure of the programmable power supply.
- **Miscellaneous Commands:** control general housekeeping functions of the programmable power supply.
- **Note:** Not all commands will be applicable to all V60 Series units (I.E., IR functions are only used by the V63). Be sure that the command you are using is a valid function for your unit.

Table 2: General Setting Commands

Commands	Explanation
:GROup <NR1>	Set the value of group
:GROup?	Query the value of group
:STEP <NR1>	Set the value of step
:STEP?	Query the value of step
:FUNctIon:TEST:MODE <NR1>	Set the value of test mode
:FUNctIon:TEST:MODE?	Query the value of test mode
:FUNctIon:TEST:STATE <NR1>	Set the value of test state
:FUNctIon:TEST:STATE?	Query the value of test state
:MEASure<x>?	Query the value of measurement
:UTILity:ACWS:FREQuency <NR1>	Set the value of AC frequency
:UTILity:ACWS:FREQuency?	Query the value of AC frequency
:UTILity:ARC:CURREnt <NR2>	Set the value of ARC current

Vitrek V60 Series – Electrical Safety Tester USER MANUAL

:UTILity:ARC:CURRent?	Query the value of ARC current
:UTILity:ARC:MODe <NR1>	Set the ARC test mode
:UTILity:ARC:MODe?	Query the ARC test mode
:UTILity:TEST:MODe <NR1>	Set the test mode from step 1 or form present setp
:UTILity:TEST:MODe?	Query the test mode
:UTILity:IRTest:MODe <NR1>	Set the value of IR test mode
:UTILity:IRTest:MODe?	Query the value of IR test mode
:ACContinuous:VOLTagE <NR2>	Set the CAC test voltage
:ACContinuous:VOLTagE?	Query the CAC test voltage
:ACContinuous:CMINimum <NR2>	Set the CAC test minimum current
:ACContinuous:CMINimum?	Query the CAC test minimum current
:ACContinuous:CMAXimum <NR2>	Set the CAC test maximum current
:ACContinuous:CMAXimum?	Query the CAC test maximum current
:ACContinuous:RTIME <NR2>	Set the CAC ramp time
:ACContinuous:RTIME?	Query the CAC ramp time
:DCContinuous:VOLTagE <NR2>	Set the CDC test voltage
:DCContinuous:VOLTagE?	Query the CDC test voltage
:DCContinuous:CMINimum <NR2>	Set the CDC test minimum current
:DCContinuous:CMINimum?	Query the CDC test minimum current
:DCContinuous:CMAXimum <NR2>	Set the CDC test maximum current
:DCContinuous:CMAXimum?	Query the CDC test maximum current
:DCContinuous:RTIME <NR2>	Set the CDC ramp time
:DCContinuous:RTIME?	Query the CDC ramp time
:ACWStanding:VOLTagE <NR2>	Set the ACW test voltage
:ACWStanding:VOLTagE?	Query the ACW test voltage
:ACWStanding:CMINimum <NR2>	Set the ACW test minimum current
:ACWStanding:CMINimum?	Query the ACW test minimum current
:ACWStanding:CMAXimum <NR2>	Set the ACW test maximum current
:ACWStanding:CMAXimum?	Query the ACW test maximum current
:ACWStanding:RTIME <NR2>	Set the ACW ramp time
:ACWStanding:RTIME?	Query the ACW ramp time
:ACWStanding:TTime <NR2>	Set the ACW test time
:ACWStanding:TTime?	Query the ACW test time
:DCWStanding:VOLTagE <NR2>	Set the DCW test voltage
:DCWStanding:VOLTagE?	Query the DCW test voltage

Vitrek V60 Series – Electrical Safety Tester USER MANUAL

:DCWStanding:CMINimum <NR2>	Set the DCW test minimum current
:DCWStanding:CMINimum?	Query the DCW test minimum current
:DCWStanding:CMAximum <NR2>	Set the DCW test maximum current
:DCWStanding:CMAximum?	Query the DCW test maximum current
:DCWStanding:RTIME <NR2>	Set the DCW ramp time
:DCWStanding:RTIME?	Query the DCW ramp time
:DCWStanding:TTime <NR2>	Set the ACW test time
:DCWStanding:TTime?	Query the ACW test time
:IRESistance:VOLtage <NR2>	Set the IR test voltage
:IRESistance:VOLtage?	Query the IR test voltage
:IRESistance:RMINimum <NR2>	Set the IR test minimum resistance
:IRESistance:RMINimum?	Query the IR test resistance
:IRESistance:RMAximum <NR2>	Set the IR test maximum resistance
:IRESistance:RMAximum?	Query the IR test resistance
:IRESistance:TTime <NR2>	Set the IR test time
:IRESistance:TTime?	Query the IR test time
:CONTInuity:RMINimum <NR2>	Set the continuity test minimum resistance
:CONTInuity:RMINimum?	Query the continuity test resistance
:CONTInuity:RMAximum <NR2>	Set the continuity test maximum resistance
:CONTInuity:RMAximum?	Query the continuity test resistance
:CONTInuity:TTime <NR2>	Set the continuity test time
:CONTInuity:TTime?	Query the continuity test time

Table 3: Status Commands

Commands	Explanation
*CLS	Clears the status data structures.
*ESE <NR1>	Sets the Event Status Enable Register (ESER).
*ESE?	Returns contents of Event Status Enable Register (ESER).
*ESR?	Returns and clear the contents of Standard Event Status Register (SESR).
*SRE <NR1>	Sets contents of Service Request Enable Register (SRER).
*SRE?	Returns contents of Service Request Enable Register (SRER).
*STB?	Reads Status Byte Register (SBR).

Vitrek V60 Series – Electrical Safety Tester USER MANUAL

:STATus:OPERation:CONDition ?	Returns the contents of the OPERation condition register. Returns NR1.
:STATus:OPERation:ENABLE <NR1>	Sets the contents of the enable mask for the OPERation event register.
:STATus:OPERation:ENABLE ?	Returns the contents of the enable mask for the OPERation event register. Returns NR1.
:STATus:OPERation:EVENT ?	Query the contents of the OPERation Event register.
:STATus:PRESet	Presets the OPERation and QUEStionable status registers.
:STATus:QUEStionable:CONDition ?	Returns the contents of the OPERation condition register. Returns NR1.
:STATus:QUEStionable:ENABLE <NR1>	Sets the contents of the enable mask for the QUEStionable enable register.
:STATus:QUEStionable:ENABLE ?	Query the contents of the Questionable Enable register.
:STATus:QUEStionable:EVENT ?	Query the contents of the QUEStionable Event register.

Table 4: Miscellaneous Commands

Command	Explanation
*IDN?	Returns instrument identification.
*OPC	Reports when operation is complete by setting the Operation Complete bit in SESR.
*OPC?	Reports when operation is complete. Same as *OPC except returns a 1 to the output queue and dose not set the SESR bit.
*RCL	Recall the setting data from the memory which previous saved.
*RST	Resets the protection levels and states, resets the current and voltage levels to zero, sets the output off, and sets memory section to 00.
*SAV	Saves the setting data to memory.
*TST?	Initiates internal self-test and reports results.
*WAI	Wait to continue. This command forces sequential operation of commands. This command is required by IEEE-488.1-1987. The power supply, however, forces sequential operation of commands by design.

7-6. Details of Command Reference

Each command in this chapter will give a detailed description. The examples of each command will be provided and what query form might return.

***CLS (no query form)**

Function:

Clear all event status data register. This includes the Output Queue, Operation Event Status Register, Questionable Event Status Register, and Standard Event Status Register.

Syntax:

*CLS

Examples:

*CLS - clears all event registers.

***ESE**

Function:

Set or return the bits in the Event Status Enable Register (ESER). The ESER enables the Standard Event Status Register (SESR) to be summarized on bit 5 (ESB) of the Status Byte Register (SBR).

Syntax:

*ESE <NR1>

*ESE?

<NR1> is in the range from 0 through 255.

Returns:

<NR1> is a number from 0 to 255 that indicates the decimal value of the binary bits of the ESER.

Examples:

*ESE 65 - sets the ESER to binary 0100 0001.

*ESE? - returns “130” if the ESER contains the binary value 1000 0010.

***ESR? (query only)**

Function:

Return and clear the contents of the Standard Event Status Register (SESR).

Syntax:

*ESR?

Returns:

<NR1> is a number from 0 to 255 that indicates the decimal value of the binary bits of the ESER.

Examples:

*ESR? - returns “198” if the ESER contains the binary value 1100 0110.

***IDN? (query only)**

Function:

Return the unique identification code of the EST.

Syntax:

*IDN?

Returns:

<string> includes Manufacturer, model number, serial number and firmware version.

Examples:

*IDN? - returns “Vitretek.Inc, V60, 0, FW1.21”

***OPC**

Function:

The command form (*OPC) sets the operation complete bit (bit 0) in the Standard Event Status Register (SESR) when all pending operations are finished.

The query form (*OPC?) tells the V60 Series to place an ASCII 1 in the Output Queue when the power supply completes all pending operations.

Syntax:

*OPC

*OPC?

Returns:

1

***RCL**

Function:

Recall the setting data from the memory saved previously.

Syntax:

*RCL <NR1>

<NR1> is in the range from 0 through 99.

Examples:

*RCL 12 - recalls the setting data stored in memory location 12

***RST (no query form)**

Function:

Set all control settings of EST to there default values but does not purge stored setting. The equivalent panel control will be set as below:

Front Panel Control	Default Setting
RESET	OFF
Rcall to RAM 0:0	ON (Stop to 0:0)

Syntax:

*RST

***SAV**

Function:

Save the setting data to a specific memory location.

Syntax:

*SAV <NR1>

<NR1> is in the range from 0 through 99.

Examples:

*SAV 01 - saves the current setting data to memory location 1.

***SRE**

Function:

Set the contents of the Service Request Enable Register (SRER). The query form returns the contents of the SRER. Bit 6 of the SRER is always zero. The bits on the SRER correspond to the bits on the SBR.

Syntax:

*SRE <NR1>

*SRE?

Returns:

<NR1> is in the range from 0 through 255.

Examples:

*SRE 7 - sets bits of the SRER to 0000 0111.

*SRE? - returns “3” if the SRER is set to 0000 0111.

***STB? (query only)**

Function:

The query of the Status Byte register (SBR) with *STB? will return a decimal number representing the bits that are set (true) in the status register.

Syntax:

*STB?

Returns:

<NR1> is in the range from 0 through 255.

Examples:

*STB? - returns “81”, if SBR contains the binary value 0101 0001.

***TST? (query only)**

Function:

Self-test and test the RAM, ROM.

Syntax:

*TST?

Returns:

0|-300

Examples:

*TST? - returns “0”, if the test is successful.

*TST? - returns “-300”, if the test is unsuccessful.

***WAI (no query form)**

Function:

WAI prevents the programming instrument from executing further commands or queries until all pending operations are finished.

Syntax:

*WAI

:GROup

Function:

Set or query the value of group.

Syntax:

:GROup <NR1>

:GROup?

<NR1> is in the range from 0 through 10.

Return:

<NR1>

Examples:

:GROup 3 - sets the group to 3.

:GROup? - returns “3” if the group setting is 3.

:STEP

Function:

Set or query the value of step

Syntax:

:STEP <NR1>

:STEP?

<NR1> is in the range from 0 through 16.

Return:

<NR1>

Examples:

:STEP 3 - sets the step to 3

:STEP? - returns “3” if the STEP setting is 3.

:FUNCTION:TEST:MODE

Function:

Set or query the test function (0:EMPTY 1: ACW 2: DCW 3: IR 4: CONT 5: CAC 6: CDC 7: HOLD)

Syntax:

:FUNCTION:TEST:MODE <NR1>

:FUNCTION:TEST:MODE?

<NR1> is in the range from 0 through 7.

Return:

<NR1>

Examples:

:FUNCTION:TEST:MODE 3 - sets the test function to IR.

:FUNCTION:TEST:MODE? - returns “3” if the test function setting is IR.

:FUNCTION:TEST:STATe

Function:

Set or query the test state (0.OFF 1. ON 2.CONTINUE)

Syntax:

:FUNCTION:TEST:STATe <NR1>

:FUNCTION:TEST:STATe?

<NR1> is in the range from 0 through 2.

Return:

<NR1>

Examples:

:FUNCTION:TEST:STATe 1 - start test.

:FUNCTION:TEST:STATe? - returns “1” if the test state is on.

:MEASure

Function:

Return measurement value

(NOTE: if no test has been run, the value returned by this function will be all zeroes)

Syntax:

:MEASure <X>?

<X> is in the range from 0 through 16 for STEP.

You must enter a step number. Do not use a space between the command and the step number.

Return:

Status, Mode, V/I, Meas, Time

(2 bytes) (1 byte) (7 bytes) (8 bytes) (7 bytes)

Status: 00:Empty
10:Pass
20:Fail
21:Interlock
22:Low Voltage
23:Hi voltage
24:ARC
25:Measurement over limit maximum
26:Measurement below limit minimum
30:Stop
32:Hight Voltage
33:Heatsink is too hot

Mode: 0: Empty

1:ACW
2:DCW
3:IR
4:CONT
5:CAC
6:CDC
7:HOLD

Vitrek V60 Series – Electrical Safety Tester USER MANUAL

V/I:

Test Function (5 bytes)	Unit (2 bytes)
ACW	KV
DCW	KV
IR	-V
CONT	-A
CAC	KV
CDC	KV
HOLD	PAUSE

Meas:

Test Function (5 bytes)	Unit (4 bytes)
ACW	MA
DCW	MA
IR	MΩ
CONT	mΩ
CAC	MA
CDC	MA
HOLD	

Time:

Time (1 byte)	Value (5 bytes)	Unit (1 byte)
Ramp	005.0	sec
Test	005.0	sec

Examples:

Use the command **:MEAS3?** after measurement
Display for PC 10,1,0.100kV,01.00mA, T005.0S
10=Pass
1=ACW
0.100kV=Measurement voltage 100V
01.00mA=Measurement current 1mA
T005.0S=Test time 5 sec

:UTILity:ACWStanding:FREQuency

:UTILity:ACContinuous:FREQuency

Function:

Set or query the ACW or CAC frequency (50 or 60Hz)

Syntax:

:UTILity:ACWStanding:FREQuency <NR>

:UTILity:ACWStanding:FREQuency?

<NR>can be 50 (50Hz) or 60 (60Hz)

Return:

50 | 60

Examples:

:UTILity:ACWStanding:FREQuency 50 - sets the ACW frequency to 50Hz

:UTILity:ACWStanding:FREQuency? - returns “50” if the ACW frequency setting is 50Hz.

(NOTE: The Test Mode must be set to either ACW or CAC before this setting can be changed)

:UTILity:ARC:CURRent

Function:

Set or query the ARC current

Syntax:

:UTILity:ARC:CURRent <NR2>

:UTILity:ARC:CURRent?

<NR2>Please refer to the specification

Return:

<NR2> is in the integer range 1 to 40mA

Examples:

:UTILity:ARC:CURRent 2 - sets the ARC current to 2.00mA.

:UTILity:ARC:CURRent? - returns “2.00” if the ARC current setting is 2.00mA.

:UTILity:ARC:MODE

Function:

Set or query the ARC test state

(0:Disable, 1:Enable & Stop, 2:Enable & Continue)

Syntax:

:UTILity:ARC:MODE <NR1>

:UTILity:ARC:MODE?

<NR1> is in the range from 0 through 2.

Return:

<NR1>

Examples:

:UTILity:ARC:MODE 0 - sets the ARC test state to “Disable”.

:UTILity:ARC:MODE? - returns “0” if the ARC mode setting is Disable.

:UTILity:TEST:MODE

Function:

Set or query the test mode (0:From Step 1, 1: From the present step)

Syntax:

:UTILity:TEST:MODE <Boolean>

:UTILity:TEST:MODE?

<Boolean>can be 0 or 1

Return:

0 | 1

Examples:

:UTILity:TEST:MODE 0 - sets the test mode to “From Step 1”.

:UTILity:TEST:MODE? - returns “0” if the mode setting is From Step 1.

:UTILity:IRTest:MODE

Function:

Set or query the IR test mode (0 :Stop on Fail, 1: Stop on Pass, 2: TIMER)

Syntax:

:UTILity:IRTest:MODE <NR1>

:UTILity:IRTest:MODE?

<NR1> is in the range from 0 through 2.

Return:

<NR1>

Examples:

:UTILity:IRTest:MODE 0 - sets the IR test mode to “Stop on Fail”.

:UTILity:IRTest:MODE? - returns “0” if the IR test mode setting is Stop on Fail.

:ACContinuous:VOLTage

Function:

Set or query the CAC test voltage.

Syntax:

:ACContinuous:VOLTage <NR2>

:ACContinuous:VOLTage?

<NR2> Please refer to the specification

Return:

<NR2>

Examples:

:ACContinuous:VOLTage 1.000 - sets the CAC test voltage to 1.000kV.

:ACContinuous:VOLTage? - returns “1.000” if the CAC test voltage setting is 1.000kV.

:ACContinuous:CMINimum

Function:

Set or query the CAC test minimum current.

Syntax:

:ACContinuous:CMINimum <NR2>

:ACContinuous:CMINimum?

<NR2> Please refer to the specification

Return:

<NR2>

Examples:

:ACContinuous:CMINimum 1.00 - sets the CAC test minimum current to 1.00mA.

:ACContinuous:CMINimum? - returns “1.00” if the CAC test minimum current setting is 1.00mA.

:ACContinuous:CMAXimum

Function:

Set or query the CAC test maximum current.

Syntax:

:ACContinuous:CMAXimum <NR2>

:ACContinuous:CMAXimum?

<NR2> Please refer to the specification

Return:

<NR2>

Examples:

:ACContinuous:CMAXimum 1.00 - sets the CAC test maximum current to 1.00mA.

:ACContinuous:CMAXimum? - returns “1.00” if the CAC maximum current setting is 1.00mA

:ACContinuous:RTIME

Function:

Set or query the CAC ramp time.

Syntax:

:ACContinuous:RTIME <NR2>

:ACContinuous:RTIME?

<NR2> Please refer to the specification

Return:

<NR2>

Examples:

:ACContinuous:RTIME 5.0 - sets the CAC ramp time to 5 sec.

:ACContinuous:RTIME? - returns “5.0” if the CAC ramp time setting is 5 sec.

:DCContinuous:VOLTage

Function:

Set or query the CDC test voltage.

Syntax:

:DCContinuous:VOLTage <NR2>

:DCContinuous:VOLTage?

<NR2> Please refer to the specification

Return:

<NR2>

Examples:

:DCContinuous:VOLTage 1.000 - sets the CDC test voltage to 1.000kV.

:DCContinuous:VOLTage? - returns “1.000” if the CDC test voltage setting is 1.000kV.

:DCContinuous:CMINimum

Function:

Set or query the CDC test minimum current.

Syntax:

:DCContinuous:CMINimum <NR2>

:DCContinuous:CMINimum?

<NR2> Please refer to the specification

Return:

<NR2>

Examples:

:DCContinuous:CMINimum 1.00 - sets the CDC test minimum current to 1.00mA.

:DCContinuous:CMINimum? - returns “1.00” if the CDC test minimum current setting is 1.00mA.

:DCContinuous:CMAximum

Function:

Set or query the CDC test maximum current.

Syntax:

:DCContinuous:CMAximum <NR2>

:DCContinuous:CMAximum?

<NR2> Please refer to the specification

Return:

<NR2>

Examples:

:DCContinuous:CMAximum 1.00 - set the CDC test maximum current to 1.00mA.

:DCContinuous:CMAximum? - returns “1.00” if the CDC test maximum current setting is 1.00mA.

:DCContinuous:RTIME

Function:

Set or query the CDC ramp time.

Syntax:

:DCContinuous:RTIME <NR2>

:DCContinuous:RTIME?

<NR2> Please refer to the specification

Return:

<NR2>

Examples:

:DCContinuous:RTIME 5.0 - sets the CDC ramp time to 5 sec.

:DCContinuous:RTIME? - returns “5.0” if the CDC ramp time setting is 5 sec.

:ACWStanding:VOLTage

Function:

Set or query the ACW test voltage.

Syntax:

:ACWStanding:VOLTage <NR2>

:ACWStanding:VOLTage?

<NR2> Please refer to the specification

Return:

<NR2>

Examples:

:ACWStanding:VOLTage 1.000 - sets the ACW test voltage to 1.000kV.

:ACWStanding:VOLTage? - returns “1.000” if the CAC test voltage setting is 1.000kV.

:ACWStanding:CMINimum

Function:

Set or query the ACW test minimum current.

Syntax:

:ACWStanding:CMINimum <NR2>

:ACWStanding:CMINimum?

<NR2> Please refer to the specification

Return:

<NR2>

Examples:

:ACWStanding:CMINimum 1.00 - sets the ACW test minimum current to 1.00mA.

:ACWStanding:CMINimum? - returns “1.00” if the ACW test minimum current setting is 1.00mA.

:ACWStanding:CMAXimum

Function:

Set or query the ACW test maximum current.

Syntax:

:ACWStanding:CMAXimum <NR2>

:ACWStanding:CMAXimum?

<NR2> Please refer to the specification

Return:

<NR2>

Examples:

:ACWStanding:CMAXimum 1.00 - sets the ACW test maximum current to 1.00mA.

:ACWStanding:CMAXimum? - returns “1.00” if the ACW test maximum current setting is 1.00mA.

:ACWStanding:RTIME

Function:

Set or query the ACW ramp time.

Syntax:

:ACWStanding:RTIME <NR2>

:ACWStanding:RTIME?

<NR2> Please refer to the specification

Return:

<NR2>

Examples:

:ACWStanding:RTIME 5.0 - sets the ACW ramp time to 5 sec.

:ACWStanding:RTIME? - returns “5.0” if the ACW ramp time setting is 5 sec.

:ACWStanding:TTIME

Function:

Set or query the CAW test time.

Syntax:

:ACWStanding:TTIME <NR2>

:ACWStanding:TTIME?

<NR2> Please refer to the specification

Return:

<NR2>

Examples:

:ACWStanding:TTIME 5.0 - sets the ACW test time to 5 sec.

:ACWStanding:TTIME? - returns “5.0” if the ACW test time setting is 5 sec.

:DCWStanding:VOLTage

Function:

Set or query the DCW test voltage.

Syntax:

:DCWStanding:VOLTage <NR2>

:DCWStanding:VOLTage

<NR2> Please refer to the specification

Return:

<NR2>

Examples:

: DCWStanding:VOLTage 1.000 - sets the DCW test voltage to 1.000kV.

: DCWStanding:VOLTage? - returns “1.000” if the DCW test voltage setting is 1.000kV.

:DCWStanding:CMINimum

Function:

Set or query the DCW test minimum current.

Syntax:

:DCWStanding:CMINimum <NR2>

:DCWStanding:CMINimum?

<NR2> Please refer to the specification

Return:

<NR2>

Examples:

:DCWStanding:CMINimum 1.00 - sets the DCW test minimum current to 1.00mA.

:DCWStanding:CMINimum? - returns “1.00” if the DCW test minimum current setting is 1.00mA.

:DCWstanding:CMAximum

Function:

Set or query the DCW test maximum current

Syntax:

:DCWStanding:CMAximum <NR2>

:DCWStanding:CMAximum?

<NR2> Please refer to the specification

Return:

<NR2>

Examples:

:DCWStanding:CMAximum 1.00 - sets the DCW test maximum current to 1.00mA.

:DCWStanding:CMAximum? - returns “1.00” if the DCW test maximum current setting is 1.00mA.

:ACWStanding:RTIME

Function:

Set or query the DCW ramp time.

Syntax:

:DCWStanding:RTIME <NR2>

:DCWStanding:RTIME

<NR2> Please refer to the specification

Return:

<NR2>

Examples:

:DCWStanding:RTIME 5.0 - sets the DCW ramp time to 5 sec.

:DCWStanding:RTIME? - returns “5.0” if the DCW ramp time setting is 5 sec.

:DCWStanding:TTIME

Function:

Set or query the DCW test time.

Syntax:

:DCWStanding:TTIME <NR2>

:DCWStanding:TTIME?

<NR2> Please refer to the specification

Return:

<NR2>

Examples:

:DCWStanding:TTIME 5.0 - sets the DCW test time to 5 sec.

:DCWStanding:TTIME? - returns “5.0” if the DCW test time setting is 5 sec.

:IRESistance:VOLTage

Function:

Set or query the IR test voltage.

Syntax:

:IRESistance:VOLTage <NR1>

:IRESistance:VOLTage?

<NR1> Please refer to the specification

Return:

<NR1> is 50, 100, 500, or 1000

Examples:

:IRESistance:VOLTage 100 - sets the IR test voltage to 100V.

:IRESistance:VOLTage? - returns “100” if the IR test voltage setting is 100V.

:IRESistance:RMINimum

Function:

Set or query the IR test minimum resistance.

Syntax:

:IRESistance:RMINimum <NR1>

:IRESistance:RMINimum

<NR1> Please refer to the specification

Return:

<NR1>

Examples:

:IRESistance:RMINimum 100 - sets the IR test minimum resistance to 100MΩ.

:IRESistance:RMINimum? - returns “100” if the IR test minimum resistance is 100MΩ.

:IRESistance:RMAXimum

Function:

Set or query the IR test maximum resistance.

Syntax:

:IRESistance:RMAXimum <NR1>

:IRESistance:RMAXimum?

<NR1> Please refer to the specification

Return:

<NR1>

Examples:

:IRESistance:RMAXimum 100 - sets the IR test maximum resistance to 100M Ω .

:IRESistance:RMAXimum? - returns “100” if the IR test maximum resistance setting is 100M Ω .

:IRESistance:TTime

Function:

Set or query the IR test time.

Syntax:

:IRESistance:TTime <NR2>

:IRESistance:TTime?

<NR2> Please refer to the specification

Return:

<NR2>

Examples:

:IRESistance:TTime 5.0 - sets the IR test time to 5 sec.

:IRESistance:TTime? - returns “5.0” if the IR test time setting is 5 sec.

:CONTinuity:RMINimum

Function:

Set or query the continuity test minimum resistance.

Syntax:

:CONTinuity:RMINimum <NR1>

:CONTinuity:RMINimum?

<NR1> Please refer to the specification

Return:

<NR1>

Examples:

:CONTinuity:RMINimum 100.0 - sets the continuity test minimum resistance to 100m Ω .

:CONTinuity:RMINimum? - returns “100” if the continuity test minimum resistance setting is 100m Ω .

:CONTInuity:RMAXimum

Function:

Set or query the continuity test maximum resistance.

Syntax:

:CONTInuity:RMAXimum <NR1>

:CONTInuity:RMAXimum?

<NR1> Please refer to the specification

Return:

<NR1>

Examples:

:CONTInuity:RMAXimum 100.0 - sets the continuity test maximum resistance to 100.0mΩ.

:CONTInuity:RMAXimum? - returns “100.0” if the continuity test maximum resistance setting is 100mΩ.

:CONTInuity:TTIME

Function:

Set or query the continuity test time.

Syntax:

:CONTInuity:TTIME <NR2>

:CONTInuity:TTIME?

<NR2> Please refer to the specification

Return:

<NR2>

Examples:

:CONTInuity:TTIME 5.0 - sets the continuity test time to 5 sec.

:CONTInuity:TTIME? - returns “5.0” if the continuity test time setting is 5 sec.

7-7. Status and Error Reporting

A set of status registers allows the user to quickly determine the EST’s internal processing status. The status register, as well as the status and event reporting system, adhere to SCPI recommendations.

The sketch of the status and event reporting system is showed in figure 7. Each component of the sketch represents a set of registers and queues that can read, report, or enable the occurrence of certain events within the system. If a specific event in the EST sets a bit in a *status register*, reading which can tell you what types of events have occurred. Each bit in the status register corresponds to a bit in an *enable register*; the enable bit must be high for the event to be reported to the Status Byte Register. A Service Request (SRQ) is the last event to occur. The SRQ requests an interrupt on the GPIB to report events to the system controller.

Status Registers.

There are two kinds of status registers are included to the programmable power supplies.

1. OPERation Status Registers (CONDition, EVENT, and ENABLE)
2. QUEStionable Status Registers (CONDition, EVENT, and ENABLE)

The lower level nodes: QUEStionable and OPERation each have three 16 bits registers: CONDition, EVENT, and ENABLE. Figure 8 shows the sequential relationship between these three types of registers and the commands that relate to each register.

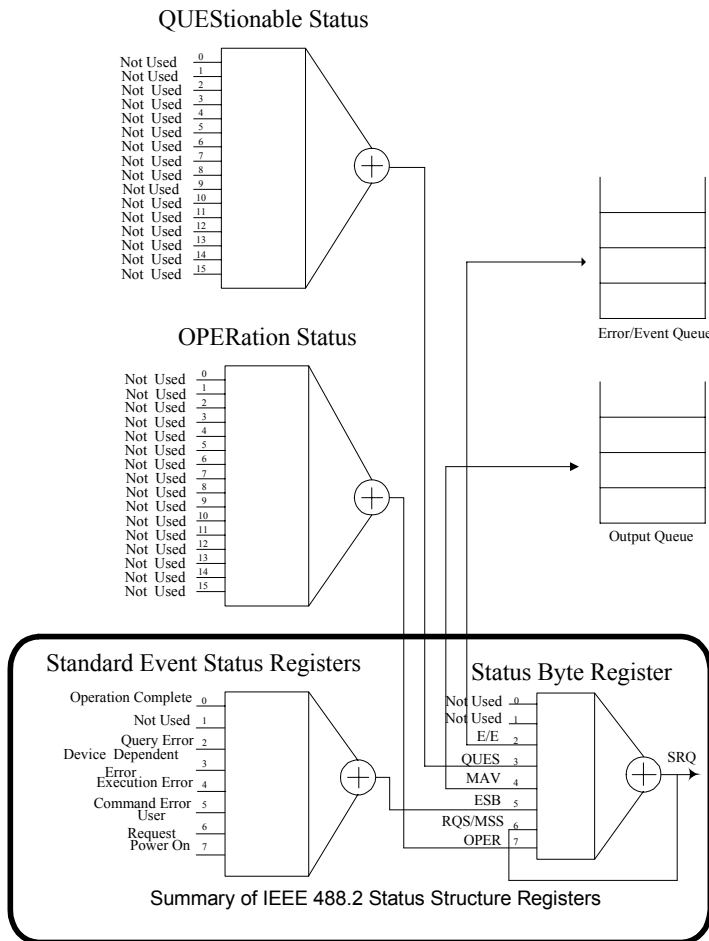
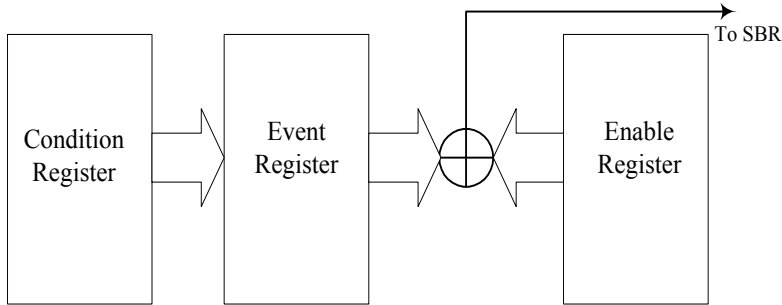

Figure 7: a graphic representation of the status register and its connections.

Figure 8: Status registers and related commands



The CONDition register is a read-only register which monitors the present state of the instrument. The CONDition register updates in real time and the inputs are not latched or buffered. When a condition monitored by the CONDition register becomes true, the bit for that condition also becomes true (1). When the condition is false, the bit is 0.

The read-only EVENT register latches any false-to-true change in condition. Once the bit in the EVENT register is set, it is no longer affected by changes in the corresponding bit of the CONDition register. The bit remains set until the controller reads it. The command *CLS (Clear Status) clears the EVENT register.

QUESTIONable Status Registers.

Table 4: 16 bit QUESTIONable Status Register

Bit 15	Bit 14	Bit 13	Bit 12	Bit 11	Bit 10	Bit 9	Bit 8
	*NU	NU	NU	NU	NU	NU	NU
Bit 7	Bit 6	Bit 5	Bit 4	Bit 3	Bit 2	Bit 1	Bit 0
NU	NU	NU	NU	NU	NU	NU	NU

The command STATUS:QUESTIONable:CONDtion? Reads the QUESTIONable CONDition register but does not clear it.

The command STATUS:QUESTIONable:EVENT? Reads the QUESTIONable EVENT Status register and clears it.

OPERation Status Registers

Table 5: 16 bit OPERation Status Register

Bit 15	Bit 14	Bit 13	Bit 12	Bit 11	Bit 10	Bit 9	Bit 8
	NU	NU	NU	NU	NU	NU	NU
Bit 7	Bit 6	Bit 5	Bit 4	Bit 3	Bit 2	Bit 1	Bit 0
NU	NU	NU	NU	NU	NU	NU	NU

* NU: not used

Status Registers

There are two status registers are included to the EST defined by IEEE-488.1 and IEEE-488.2 standards.

1. Status Byte Register (SBR)
2. Standard Event Status Register (SESR)

Status Byte Register (SBR): The SBR (Table 6) summarizes the status of all other registers and queues.

Table 6: Status Byte Register (SBR)

Bit 7	Bit 6	Bit 5	Bit 4	Bit 3	Bit 2	Bit 1	Bit 0
OPER	RQS/MSS	ESB	MAV	QUES	E/E	NU	NU

The bit 0 and 1 are not used, so these bits are always zero. The bit 2 (Error and Event) indicates an error code is waiting to be read in the Error Event Queue. The bit 3 (QUES, QUEStionable) is the summary bit for the QESR (QUEStionable Event Status Register). When the bit is high it indicates that status is enabled and present in the QUES. The bit 4 (MAV, Message Available) indicates that output is available in the output queue. The bit 5 (ESB, Event Status Bit) is the summary bit for the Standard Event Status Register (SESR). When the bit is high it indicates that status is enabled and present in the SESR. The bit 6 (RQS, Request Service) is obtained from a serial poll and shows that the EST requests service from the GPIB controller. The bit 7 (OPER, OPERation) is the summary bit for the OESR (OPERation EVENt STATus Register).

Use the serial poll or the *STB? Query to read the contents of the SBR. The bits in the SBR are set and cleared depending on the contents of the Standard Event Status Register (SESR), the Standard Event Status Register (SESR), and the Output Queue.

Table 7: Standard Event Status Register (SESR)

Bit 7	Bit 6	Bit 5	Bit 4	Bit 3	Bit 2	Bit 1	Bit 0
PON	URQ	CME	EXE	DDE	QYE	NU	OPC

The bit 0 (OPC, Operation Complete) shows that the operation is completed. This bit is active when all pending operations are completed following an *OPC command. The bit 1 is always zero. The bit 2 (QYE, Query Error) indicates a command or query protocol error. The bit 3 (DDE, Device Error) shows that a device error occurred. The bit 4 (EXE, Execution Error) shows that an error occurred while the EST was executing a command or query. The bit 5 (CME, Command Error) shows that an error occurred while the EST was parsing a command or query. The bit 6 (USR, User Request) indicates the LOCAL button was pushed. The bit 7 (PON, Power On) shows that the EST was powered on.

Use the *ESR? Query to read the SESR. Read the SESR and clear the bits of the registers so that the register can accumulate information about new events.

Enable Registers

The enable registers determine whether certain events are reported to the Status Byte Register and SRQ. The EST has the following enable registers:

- Event Status Enable Register (ESER)
- OPERation Enable Register
- QUEStionable Enable Register

Service Request Enable Register (SRER)

When one of the bits of the enable registers is high and the corresponding bit in the status register is high, the enable registers will perform a logical OR function, the output that controls the set bit of the Status Byte Register is high.

Various commands set the bits in the enable registers. The following sections describe the enable registers and the commands that set them:

- **Event Status Enable Register (ESER):** The ESER controls which types of events are summarized by the Event Status Bit (ESB) in the SBR. The bits of the ESER correspond to the bits of the SESR. Use the *ESE command to set the bits in ESER. Use the *ESE? query to read it.
- **OPERation Enable Register:** Even though the OPERation Enable Register is present in the V60 Series, the OPERation registers do not report any conditions.
- **QUEStionable Enable Register:** The QUEStionable Enable Register controls which types of events are summarized by the QUES status bit in the SBR. Use the STATus:QUEStionable:ENABLE command to set the bits in the QUEStionable Enable register. Use the STATus:QUEStionable:ENABLE? query to read it.
- **Service Request Enable Register (SRER):** The SRER controls which bits in the SBR generate a service request. Use the *SRE command to set the SRER. Use the *SRE? query to read it.

Queues

Output Queue: The V60 Series store query responses in the output queue by succeeding the IEEE 488.2 protocol. If the power supply receives a new command or query message after a message terminator, the power supply will clear and reset this queue each time. The computer must read a query response before it sends the next command (or query) or it loses response to earlier queries. The output queue is included to power supplies.

Error/Event Queues: When an error or event occurs, the output queue stores the message. The output queue stores and reports the messages on a FIFO (first in first out) state. The SYSTem:ERRor? query reads the next item from the output queue. If output queue overflows, the error message is -350, "Queue overflow"; the queue can't store or report succeeding messages till it is read or cleared.

Error Message

Table 8: The SCPI error messages for the programmable power supplies

SCPI Error Code and Description	SESR Bit
0, "No error"	
-100, "Command error"	5
-200, "Execution Error"	4
-221, "Settings conflict"	4
-221, "Settings conflict; Timer setting error"	4
-221, "Settings conflict; Voltage setting error"	4
-221, "Settings conflict; Current setting error"	4
-221, "Settings conflict; Resistance setting error"	4
-221, "Settings conflict; Frequency setting error"	4

Vitrek V60 Series – Electrical Safety Tester USER MANUAL

-221, "Settings conflict; Recall setting error"	4
-222, "Data out of range;"	4
-222, "Data out of range; Timer too large"	4
-222, "Data out of range; Voltage too large"	4
-222, "Data out of range; Current too large"	4
-222, "Data out of range; Resistance too large"	4
-222, "Data out of range; Timer too small"	4
-222, "Data out of range; Voltage too small"	4
-222, "Data out of range; Current too small"	4
-222, "Data out of range; Resistance too small"	4
-240, "Hardware Error"	3
-300, "Device-specific error"	3
-310, "System error"	3
-330, "Self-test failed"	3
-350, "Queue overflow"	3
-410, "Query INTERRUPTED"	2
-420, "Query UNTERMINATED"	2
-430, "Query DEADLOCKED"	2

8. MAINTENANCE

The following instructions should be used only by a qualified person in order to avoid electrical shock. Do not perform any service other than contained in the operation instructions unless you are qualified to do so.

8-1. Fuse Rating and type

If the fuse blows, the FUNCTION GENERATOR will not operate. Try to determine and correct the cause of the blown fuse, then replace the fuse with the correct rating and type shown as below:

Line voltage	Range	Fuse	Line voltage	Range	Fuse
100V	90-110V	T 4.0A	220V	198-242V	T 4.0A
120V	108-132V	250V	230V	207-250V	250V



WARNING: For continued fire protection, replace only with 250V fuse of the specified type and rating, and disconnect the power cord before proceeding fuse replacement.

8-2. Cleaning

To keep the instrument clean, wipe the case with a damp cloth and detergent. Do not use abrasives or solvents.

8-3. Trouble Shooting

Problem: Unit passes continuity test even when leads are disconnected.

Solution: Unit has improper test lead zeroing. Press “Utility” key use knob to select “Conti Calibration Util” short Continuity and return test leads together and then press the “start” button.

Problem: PLC start input does not work.

Solution: Unit has not been set to correct PLC mode. Press “Utility” key use knob to select “TEST CONTROL MODE. Press the SAVE/EDIT key to edit the field and use the knob to select MODE 3: PLC ENABLE, then press SAVE/EDIT to save the setting and press MENU to exit the utility mode. The unit is now configured for remote operation.

Problem: Start button does not start test.

Solution: Unit is set to PLC mode 3. Press “Utility” key use knob to select “TEST CONTROL MODE. Press the SAVE/EDIT key to edit the field and use the knob to select MODE 1: Normal, then press SAVE/EDIT to save the setting and press MENU to exit the utility mode. The unit is now set for front panel operation.

Problem: ACW or DCW test fails right away with DUT attached or even with no DUT.

Solution: Check the setting for minimum current. If it is set above zero, then set to 0.00mA and try again. Any reading below the minimum current limit value will cause an immediate failure.

Problem: Unit reports “Error ACW Hot Heatsink”

Solution: The V60 series EST’s are not designed to source current above 10mA for more than 10 seconds. Repeated high duty cycle use above 10mA will cause overheating to occur.

8- 4. V60 Series Failure Indications

Note: All indicators occur after you press the reset button to stop the tone, but before you press the reset button to reset the test. It is very easy to just hit the reset button twice and miss these error messages, as they often do not show up for a second after the first press of the reset button.

Failure	Indication
Imeas is less than Imin	The Imeas field in the lower left hand corner of the LCD will change to Imin and blink slowly, displaying the current that failed, not the current Imin setting.
Imeas is greater than Imax	The Imeas field in the lower left hand corner of the LCD will change to Imax and blink slowly, displaying the current that failed, not the current Imax setting.
Rmeas is greater than Rmax	The Rmeas field in the lower left hand corner of the LCD will change to Rmax and blink slowly, displaying the resistance that failed, not the current Rmax setting.
Rmeas is less than Rmin	The Rmeas field in the lower left hand corner of the LCD will change to Rmin and blink slowly, displaying the resistance that failed, not the current Rmax setting.
Arc (with arc detection disabled)	When running a test and an arc failure occurs, the test will fail, but the tester will be displaying a voltage under the set voltage. After pressing reset once, the Imax field will blink, even though the Imeas is still less than the Imax
Arc (with arc detection set to Enable & Stop)	When an arc is detected during a test, a star (*) will appear to the right of the voltage. The test will fail immediately, and upon pressing the reset button once, the star will blink.
Arc (with arc detection set to Enable & Continue)	When an arc is detected in this mode, a star (*) will appear to the right of the voltage, but the test will continue. If the test fails due to the arc breaking down, it will display a voltage under the user’s setting, and after pressing the reset button once, the Imeas field will change to Imax and start blinking, even if the Imeas is under the Imax.

8-5. Vitrek V60 Series Calibration Procedure

Calibration Procedure No. V60-020502

The following procedure will provide verification of the calibration status of the Vitrek V60 Series EST. Utilize the attached V60 Series calibration data sheet for verification sequence, nominal values and maximum allowable tolerance. Not all units in the V60 series have all functions. Omit test points for any given unit where dashes are shown.

Calibration Verification Equipment

Precision AC/DC High Voltage Meter (Vitrek model 4600A or equivalent)

Vitrek 4610A (or 501) HV Standard Resistor Set - 1Ω, 100kΩ (10watts minimum), 1MΩ, 100MΩ, 1GΩ

Verification Procedure

1. Using ACW mode, measure and record the AC output voltages of the V60 Series at settings of 1000 and 5000VAC.
2. Reduce output to zero and hook-up 1MΩ across HV output and return. Apply 1000VAC to resistor and record 1mA reading. Be sure to correct reading for any known deviation from 1000VAC output.
3. Repeat step 2 using 100kΩ for 10mA reading.
4. Using DCW mode, measure and record the DC output voltages of the V60 Series at settings of 1000 and 6000VDC.
5. Using DCW mode, output 1000VDC into a 1MΩ resistor to record 1mA reading. Note: minimum load impedance for DC mode is 330k ohm.
6. Using the IR mode, measure and record 100MΩ and 1GΩ resistors.
7. Use continuity cal function (under “utility”) to “zero out” lead resistance prior to checking continuity accuracy. Using continuity mode, measure and record 1Ω resistor

V60 Series Calibration Data Chart

Nominal Values	V60	V61	V62	V63	Maximum Tolerance
1000VAC					± 15V
5000VAC					± 55V
1mA AC					± .06mA
10mA AC					± .15mA
1000VDC	-----		-----		± 15VDC
6000VDC	-----		-----		± 65VDC
1mA DC	-----		-----		± .06mA
100MΩ	-----	-----			± 5MΩ
1000MΩ	-----	-----			± 100MΩ
1Ω					± .100Ω

Calibration for each module

The Vitrek V60 Series ESTs can be divided into several modules for calibration & adjustment. The modules consist of: main board, isolation board, AC withstanding voltage, DC withstanding voltage, IR, and Continuity check.

Model	Main Board	Insulating board	AC withstanding voltage	DC withstanding voltage	IR	Continuity check
V60	*	*	*	-	-	*
V61	*	*	*	*	-	*
V62	*	*	*	-	*	*
V63	*	*	*	*	*	*

Calibration Modules

Calibration procedures are built in the software of the EST series. Please follow as:

1. Connect with high voltage transformer & main board. The safety cover should be closed.
2. Press UTILITY key and press power SW. While the machine is turned on, keep pressing the UTILITY key until the LCD shows “PRESS START TO PROCESS”.
3. While the machine is warmed up, the LCD monitor will display the model name.
4. Check the model name. If it’s not the same model name, turn off the power and repeat the “MODEL SETTING”.
5. In the meantime, EST series will self test the grounding condition of power line. If the earth check failed, EST series will be alarmed. Therefore, turn off the power and re-check grounding again.
6. If self-test is passed, the LCD monitor will display the “PRESS START TO PROCESS” message. Press START key to begin calibration procedures.
7. Select the calibration modules by pressing the left & right arrow key. Press START key to begin calibration procedures. The calibration procedures are following:

STEP 1: AC withstanding voltage- voltage adjustment procedure (STEP1:ACV)

1. Connect V60 Series unit to Vitrek 4600A high voltage meter.

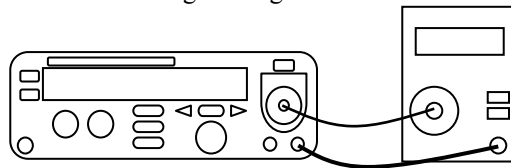

2. Follow ” **Modules Calibration Starting Procedures**”, Select the calibration module “**STEP 1: ACV**”. Press START key to begin calibration procedures.
3. The “50Hz 600V” will be calibrated first. Use knob and left & right arrow key to adjust the value of the LCD monitor. The readout of high voltage meter shall be monitored in the same time. If the meter’s readout reach to 600V ($\pm 2V$), wait for 3 seconds and press EDIT/SAVE key.
4. Repeat step 3 for “50Hz 3000V”, “60Hz 600V”, and “60Hz 3000V” in sequence.
5. After calibration of 4 sets voltage are finished, the LCD monitor will go back the original display. Press the left & right arrow key to select the next calibration procedure-“**DC withstanding voltage- voltage adjustment procedure**”. (V60 & V62 will jump to “**AC withstanding voltage- current adjustment**”.

proceduce” directly.)

STEP 2: DC withstanding voltage- voltage adjustment proceduce (STEP2:DCV)

1. The calibrations of “**DC withstanding voltage- voltage adjustment proceduce**” and “**AC withstanding voltage- voltage adjustment proceduce**” are similar. Switch the high voltage meter to “DCV” and press “START” key to calibrate “DC 600V” , “DC 3000V” in sequence. (error deviation is $\pm 2V$). Wait for 3 seconds and press EDIT/SAVE key finally.
2. After calibration of 2 sets voltage are finished, the LCD monitor will go back the orginal display. Press the left & right arrow key to select the next calibration proceduce-“**AC withstanding voltage- current adjustment proceduce**”.

STEP 3: AC withstanding voltage- current adjustment proceduce (STEP 3: ACI)

1. Connect a 600K Ω /150W resistor with DMM (on the range of AC True RMS current 20mA) and EST in series.

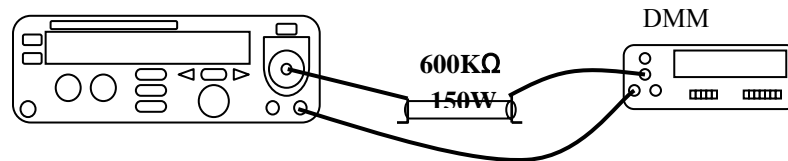

2. Select the “**STEP 3: ACI**” modules by pressing the left & right arrow key. Press START key to begin calibration proceduces.
3. The “50Hz 1mA” will be calibrated in advance. Use knob and left & right arrow key to adjust the value of the LCD monitor. The readout of DMM shall be monitored in the same time. If the meter’s readout reach to 1.000mA ($\pm 0.005mA$), wait for 3 seconds and press EDIT/SAVE key to “AUTO Calibration” mode. EST series will send an output voltage and adjust the setting of cutting current automatically. If entire calibration proceduce is finished, the LCD monitor will display an “ADJ to 5mA” message. EST series is going to next calibration proceduce for “50Hz 5mA”.
4. Repeat step 3 for “50Hz 5mA”, “60Hz 1mA”, and “60Hz 5mA” in sequence.
After calibration of 2 sets current are finished, the LCD monitor will go back the orginal display. Press the left & right arrow key to select the next calibration proceduce-“**DC withstanding voltage- current adjustment proceduce**”. (V60 will jump to “**Continuity check adjustment proceduce**” directly; V62 will jump to “**IR adjustment proceduce**” directly)

STEP 4: DC withstanding voltage- current adjustment proceduce (STEP 4: DCI)

1. The calibrations of “**DC withstanding voltage- current adjustment proceduce**” and “**AC withstanding voltage- current adjustment proceduce**” are similar. Connect a 1.2M Ω /50W resistor with DMM (on the range of DC current 20mA) and EST in series. Switch the EST to “DCI” module and press “START” key to calibrate “DC 0.5mA” , “DC 2.5mA” in sequence. (error deviation is $\pm 0.005\text{mA}$). Wait for 3 seconds and press EDIT/SAVE key finally.

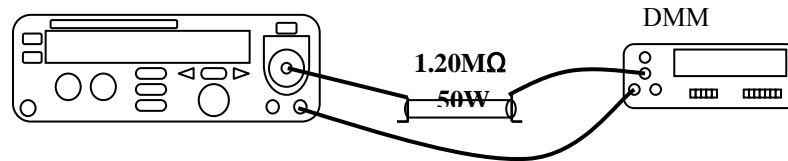

2. After calibration of 2 sets current are finished, the LCD monitor will go back the original display. Press the left & right arrow key to select the next calibration procedure-“**Insulation Resistance adjustment proceduce**”. (V61 will jump to “**Continuity check adjustment proceduce**” directly)

STEP 5: Insulation Resistance adjustment proceduce (STEP 5: IR)

Select the "STEP 5:IR" modules by pressing the left & right arrow key. Press START key to begin the voltage calibration procedure.

LCD monitor will display a "calibration voltage 50V" message.

Connect high voltage meter (DC) to HV output and return.

Rotate knob to 50V, press EDIT/SAVE key.

LCD monitor will display an "IR 2000M" message.

Connect the 2000 M Ω of "HIGH RESISTANCE BOX (SR-2)" with EST.

Press START key to begin calibration procedures. When the entire calibration procedure is finished, the LCD monitor will display an "IR 50 M Ω " message.

Connect the 50 M Ω "HIGH RESISTANCE BOX (SR-2)" with EST.

Press START key to begin calibration procedures. When the entire calibration procedure is finished, the LCD monitor will display an "IR 100 M Ω " message.

Connect the 100 M Ω "HIGH RESISTANCE BOX (SR-2)" with EST.

Press START key to begin calibration procedures. When the entire calibration procedure is finished, the LCD monitor will display an "IR 2.5 M Ω " message.

Vitrek V60 Series – Electrical Safety Tester USER MANUAL

Connect the 2.5 M Ω "HIGH RESISTANCE BOX (SR-2)" with EST.
Press START key to begin calibration procedures. When the entire calibration procedure is finished, the LCD monitor will display a "calibration voltage 100V" message.

Connect high voltage meter (DC) to HV output and return.
Rotate knob to 100V, press EDIT/SAVE key.
LCD monitor will display an "IR 2000M" message.

Connect the 2000 M Ω of "HIGH RESISTANCE BOX (SR-2)" with EST.
Press START key to begin calibration procedures. When the entire calibration procedure is finished, the LCD monitor will display an "IR 50 M Ω " message.

Connect the 50 M Ω "HIGH RESISTANCE BOX (SR-2)" with EST.
Press START key to begin calibration procedures. When the entire calibration procedure is finished, the LCD monitor will display an "IR 100 M Ω " message.

Connect the 100 M Ω "HIGH RESISTANCE BOX (SR-2)" with EST.
Press START key to begin calibration procedures. When the entire calibration procedure is finished, the LCD monitor will display an "IR 2.5 M Ω " message.

Connect the 2.5 M Ω "HIGH RESISTANCE BOX (SR-2)" with EST.
Press START key to begin calibration procedures. When the entire calibration procedure is finished, the LCD monitor will display a "calibration voltage 500V" message.

Connect high voltage meter (DC) to HV output and return.
Rotate knob to 500V, press EDIT/SAVE key.
LCD monitor will display an "IR 2000M" message.

Connect the 2000 M Ω of "HIGH RESISTANCE BOX (SR-2)" with EST.
Press START key to begin calibration procedures. When the entire calibration procedure is finished, the LCD monitor will display an "IR 50 M Ω " message.

Connect the 50 M Ω "HIGH RESISTANCE BOX (SR-2)" with EST.
Press START key to begin calibration procedures. When the entire calibration procedure is finished, the LCD monitor will display an "IR 100 M Ω " message.

Connect the 100 M Ω "HIGH RESISTANCE BOX (SR-2)" with EST.
Press START key to begin calibration procedures. When the entire calibration procedure is finished, the LCD monitor will display an "IR 2.5 M Ω " message.

Connect the 2.5 M Ω "HIGH RESISTANCE BOX (SR-2)" with EST.
Press START key to begin calibration procedures. When the entire calibration procedure is finished, the LCD monitor will display a "calibration voltage 1000V" message.

Vitrek V60 Series – Electrical Safety Tester USER MANUAL

Connect high voltage meter (DC) to HV output and return.

Rotate knob to 1000V, press EDIT/SAVE key.

LCD monitor will display an "IR 2000M" message.

Connect the 2000 M Ω of "HIGH RESISTANCE BOX (SR-2)" with EST.

Press START key to begin calibration procedures. When the entire calibration procedure is finished, the LCD monitor will display an "IR 50 M Ω " message.

Connect the 50 M Ω "HIGH RESISTANCE BOX (SR-2)" with EST.

Press START key to begin calibration procedures. When the entire calibration procedure is finished, the LCD monitor will display an "IR 100 M Ω " message.

Connect the 100 M Ω "HIGH RESISTANCE BOX (SR-2)" with EST.

Press START key to begin calibration procedures. When the entire calibration procedure is finished, the LCD monitor will display an "IR 2.5 M Ω " message.

Connect the 2.5 M Ω "HIGH RESISTANCE BOX (SR-2)" with EST.

Press START key to begin calibration procedures. When the entire calibration procedure is finished, the LCD monitor will go back the original display.

STEP6:Continuity check adjustment procedure (STEP6:Cont)

1. Select the "STEP 6: CONT" modules by pressing the left & right arrow key. Press START key to begin calibration procedures. The LCD monitor will display a "GC SHORT" message.
2. The two "RETURN" and "CONT CHECK" terminals shall be shorted circuit.
3. Press START key to begin calibration procedures.
4. If entire calibration procedure is finished, the LCD monitor will display a "GC 1 Ω " message.
5. The two "RETURN" and "CONT CHECK" terminals shall be connected with a 1 Ω resistor.
6. Press START key to start calibration procedures.
7. If entire calibration procedure is finished, the LCD monitor will go back the original display.

For technical support email info@vitrek.com