



#### **WARRANTY**

The Anritsu product(s) listed on the title page is (are) warranted against defects in materials and workmanship for one year from the date of shipment.

Anritsu's obligation covers repairing or replacing products which prove to be defective during the warranty period. Buyers shall prepay transportation charges for equipment returned to Anritsu for warranty repairs. Obligation is limited to the original purchaser. Anritsu is not liable for consequential damages.

#### **LIMITATION OF WARRANTY**

The foregoing warranty does not apply to Anritsu connectors that have failed due to normal wear. Also, the warranty does not apply to defects resulting from improper or inadequate maintenance by the Buyer, unauthorized modification or misuse, or operation outside the environmental specifications of the product. No other warranty is expressed or implied, and the remedies provided herein are the Buyer's sole and exclusive remedies.

#### **TRADEMARK ACKNOWLEDGEMENTS**

MS-DOS, Windows, Windows for Workgroups, Windows NT, and Windows 95 are registered trademarks of the Microsoft Corporation. **Site Master** and **Cable Mate** are trademarks of Anritsu Company.

#### **NOTICE**

Anritsu Company has prepared this manual for use by Anritsu Company personnel and customers as a guide for the proper installation, operation and maintenance of Anritsu Company equipment and computer programs. The drawings, specifications, and information contained herein are the property of Anritsu Company, and any unauthorized use or disclosure of these drawings, specifications, and information is prohibited; they shall not be reproduced, copied, or used in whole or in part as the basis for manufacture or sale of the equipment or software programs without the prior written consent of Anritsu Company.

## DECLARATION OF CONFORMITY

**Manufacturer's Name:** ANRITSU COMPANY

**Manufacturer's Address:** Microwave Measurements Division  
490 Jarvis Drive  
Morgan Hill, CA 95037-2809  
USA

declares that the product specified below:

**Product Name:** Site Master

**Model Number:** S251A

conforms to the requirement of:

EMC Directive 89/336/EEC as amended by Council Directive 92/31/EEC & 93/68/EEC  
Low Voltage Directive 73/23/EEC as amended by Council directive 93/68/EEC

### **Electromagnetic Interference:**

Emissions: CISPR 11:1990/EN55011:1991 Group 1 Class A

Immunity: EN 61000-4-2:1995/EN50082-1:1997 - 4kV CD, 8kV AD  
EN 61000-4-3:1997/EN50082-1:1997 - 3V/m  
ENV 50204/EN50082-1:1997 3V/m  
EN 61000-4-4:1995/EN50082-1:1997 - 0.5kV SL, 1kV PL  
EN 61000-4-5:1995/EN50082-1:1997 - 1kV L-L, 2kV L-E

### **Electrical Safety Requirement:**

Product Safety: The Product Complies when used with Company supplied Power  
Supply (tested to EN 60950)

Morgan Hill, CA

  
\_\_\_\_\_  
Manager of Corporate Quality

5/11/98  
\_\_\_\_\_  
Date

European Contact: For Anritsu product EMC & LVD information, contact Anritsu LTD, Rutherford Close,  
Stevenage Herts, SG1 2EF UK, (FAX 44-1438-740202)

# *Table of Contents*

---

<b>General Information . . . . .</b>	<b>1-1</b>
<b>Introduction. . . . .</b>	<b>1-1</b>
<b>Description . . . . .</b>	<b>1-1</b>
<b>Standard Accessories . . . . .</b>	<b>1-2</b>
<b>Options . . . . .</b>	<b>1-3</b>
<b>Optional Accessories . . . . .</b>	<b>1-3</b>
<b>Performance Specifications . . . . .</b>	<b>1-5</b>
<b>Preventive Maintenance . . . . .</b>	<b>1-8</b>
<b>Calibration . . . . .</b>	<b>1-9</b>
<b>Annual Verification . . . . .</b>	<b>1-10</b>
<b>Connectors and Controls . . . . .</b>	<b>2-1</b>
<b>Introduction. . . . .</b>	<b>2-1</b>
<b>Test Panel Connectors . . . . .</b>	<b>2-1</b>
<b>Keypad Controls . . . . .</b>	<b>2-2</b>
<b>Soft Keys and Menus . . . . .</b>	<b>2-7</b>
<b>Determining Remaining Battery Life . . . . .</b>	<b>2-26</b>
<b>Printing. . . . .</b>	<b>2-27</b>
Printer Switch Settings . . . . .	2-27
Printing a Screen . . . . .	2-28
<b>Symbols . . . . .</b>	<b>2-29</b>
<b>Self Test . . . . .</b>	<b>2-29</b>
<b>Error Codes . . . . .</b>	<b>2-29</b>
Self Test Errors . . . . .	2-29
Range Errors . . . . .	2-29
<b>Replacing the Battery . . . . .</b>	<b>2-29</b>
<b>Using the Soft Carrying Case. . . . .</b>	<b>2-35</b>

<b>Operation . . . . .</b>	<b>3-1</b>
<b>Introduction . . . . .</b>	<b>3-1</b>
<b>Operating Functions . . . . .</b>	<b>3-1</b>
<b>Making Common Function Selections . . . . .</b>	<b>3-3</b>
Applying Power . . . . .	3-3
Setting Options . . . . .	3-3
Setting Markers . . . . .	3-3
Setting Scale/Limits . . . . .	3-4
<b>Return Loss (SWR) and Cable Loss</b>	
<b>(One Port) Measurement . . . . .</b>	<b>3-5</b>
Required Equipment . . . . .	3-5
Device-Under-Test Specification . . . . .	3-5
Procedure . . . . .	3-5
Selecting the Measurement Mode . . . . .	3-5
Selecting the Frequency Range . . . . .	3-7
Performing a Calibration . . . . .	3-7
Cable Return Loss Measurement . . . . .	3-9
Setting the Limit Line . . . . .	3-9
Setting the Markers . . . . .	3-9
Saving Display to Memory . . . . .	3-11
Cable Loss Measurement . . . . .	3-11
Scaling the Display . . . . .	3-11
Saving Display to Memory . . . . .	3-12
<b>DTF Measurement . . . . .</b>	<b>3-13</b>
Required Equipment . . . . .	3-13
Device-Under-Test Specification . . . . .	3-13
Procedure . . . . .	3-13
DTF Parameters Setup . . . . .	3-13
Performing a Calibration . . . . .	3-15
DTF Measurement (Determining the Length	
of the Cable) . . . . .	3-16
DTF Measurement (Determining the Quality	
of the Cable) . . . . .	3-18
<b>Insertion Gain (Amplifier) Measurement . . . . .</b>	<b>3-20</b>
Required Equipment . . . . .	3-20

Device-Under-Test Specification . . . . .	3-20
Procedure . . . . .	3-20
Insertion Gain Mode Selection . . . . .	3-20
Selecting the Frequency Range . . . . .	3-21
Performing a Calibration. . . . .	3-21
Amplifier Gain Measurement . . . . .	3-24
Setting the Markers. . . . .	3-24
Activating the Bias Tee . . . . .	3-27
Scaling the Display . . . . .	3-27
Saving Display to Memory . . . . .	3-28
<b>Making Power Measurements . . . . .</b>	<b>3-29</b>
Entering Power Monitor Mode . . . . .	3-29
Zeroing the Power Monitor . . . . .	3-29
Measuring High Input Power Levels . . . . .	3-29
Displaying Power in dBm and Watts . . . . .	3-30
Displaying Relative Power . . . . .	3-30
<b>RF Source Operation . . . . .</b>	<b>3-31</b>
Generating a CW Frequency. . . . .	3-31
<b>Software Tools Program . . . . .</b>	<b>4-1</b>
Description . . . . .	4-1
Requirements . . . . .	4-1
<b>Communication Port Setting. . . . .</b>	<b>4-2</b>
Changing COM Port Settings–Windows 3.1 . . . . .	4-2
Changing COM Port Settings–Windows 95 . . . . .	4-4
<b>Software Installation . . . . .</b>	<b>4-6</b>
<b>Plot Capture. . . . .</b>	<b>4-8</b>
Capture multiple to database . . . . .	4-8
Capture multiple traces to PC screen. . . . .	4-9
Single trace capture. . . . .	4-10
<b>Program Operation . . . . .</b>	<b>4-11</b>
<b>Fault Location Software . . . . .</b>	<b>4-11</b>
<b>Smith Chart Software. . . . .</b>	<b>4-12</b>
<b>Saving a Plot as a Windows Metafile. . . . .</b>	<b>4-12</b>

<b>Saving Data to a Spreadsheet. . . . .</b>	<b>4-13</b>
<b>Saving Data to a Database . . . . .</b>	<b>4-13</b>
<b>“Drag-n-Drop” . . . . .</b>	<b>4-14</b>
<b>Printing. . . . .</b>	<b>4-14</b>
<b>Appendix A Reference Data . . . . .</b>	<b>A-1</b>
<b>Description . . . . .</b>	<b>A-1</b>

## How to Use this Manual

The operation of the **Site Master**™ is straightforward and intuitive. However, you may find it helpful to review the operation of the keys and menus prior to first-time use.

Descriptions of the keys and menus are provided in Chapter 2; measurement procedures are found in Chapter 3.

First-time users and maintenance supervisors will benefit from perusing the material in Chapter 1. This chapter describes the instrument and provides listings of options, accessories, and performance specifications.

---

### Please Recycle

This product contains a rechargeable nickel-cadmium battery. Spent nickel-cadmium batteries are valuable resources, do not throw them away. Arrange for proper return for recycling in your locality. If you do not have access to proper disposal methods, return the battery to your Anritsu service center.

Anritsu service centers will dispose of the unit at no charge. Anritsu service centers are listed in Table 1-2 (page 1-11).



*NiCd*

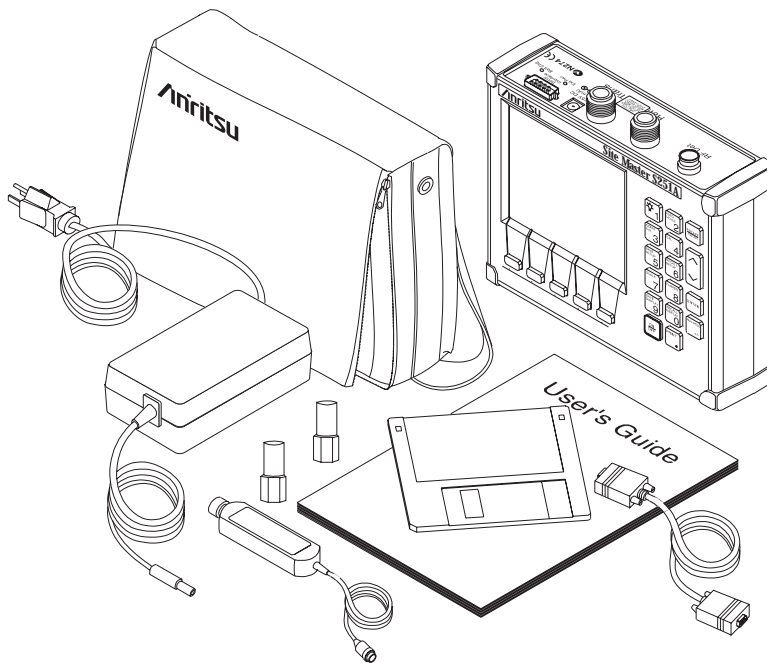

---

Figure 1-1. Site Master System

**1 - 0**



# Chapter 1

## General Information



### Introduction

This chapter provides a description, performance specifications, optional accessories, preventive maintenance, and calibration requirements for the **Site Master** model **S251A**. Throughout this manual, the term **Site Master** will refer to the model **S251A**.

<u>Model</u>	<u>Frequency Range</u>
S251A	625 to 2500 MHz

### Description

The **Site Master** (Figure 1-1) is a hand held  $S_{21}$  (transmission gain or loss), SWR/RL (standing wave ratio/return loss), and Distance-To-Fault (DTF) measurement instrument that includes a built-in synthesized signal source and an optional power monitor. It uses a keypad to enter data and a liquid crystal display (LCD) to provide a graphical indication of  $S_{21}$ , SWR, or RL over the selected frequency range. The **Site Master** has a built-in distance-to-fault (DTF) capability. It is capable of up to two hours of continuous operation from a fully charged internal battery and can be operated from a 12.5 dc source (which will also simultaneously charge the battery). Built-in energy conservation features can be used to extend battery life over an eight-hour work day.

The **Site Master** is designed for measuring transmission gain/insertion loss, SWR, return loss, or cable insertion loss and locating faulty RF

components in antenna systems. Power monitoring and bias tee capabilities are available as options. The displayed trace can be scaled and/or enhanced with settable frequency markers and/or a limit line. A menu option provides for an audible “beep” when the limit value is exceeded. To permit use in low-light environments, the LCD can be back lit using a front panel key.

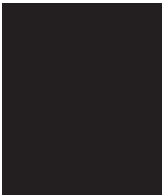

## **Standard Accessories**

A PC based software program (called Software Tools) provides an on-line database record for storing measurement data. **Site Master** Software Tools can also convert the **Site Master** display to a Microsoft Windows 95 graphic. Measurements stored in the **Site Master** internal memory are down-loaded to the PC using the included serial cable. This null-modem serial cable connects between the Serial Interface connector on the **Site Master** and a Com Port on a DOS/Windows-based PC. Once stored, the graphic trace can then be displayed, scaled, and/or enhanced with markers and limit lines. Historical graphs can be overlaid with current data by using the PC's mouse in “drag-n-drop” fashion. The underlying data can be extracted and used in spreadsheets or for other analytical tasks.

The Software Tools program also performs DTF (Distance To Fault) or Fault Location by clicking on the appropriate icon.

The following items are supplied with the basic hardware.

- Soft Carrying Case
- AC-DC Adapter
- Automotive Cigarette Lighter 12 Volt DC Adapter,
- 3 1/2-inch floppy disk containing the Software Tools program. This program contains Fault Location (DTF) and Smith Chart functions
- Serial Interface Cable (Null Modem Type)
- One year Warranty (includes battery, firmware, and software)
- User's Guide



## Options

- Option 5 — Add RF Wattmeter Power Monitor
- Option 10 — Add Bias Tee

## Optional Accessories

- Anritsu Precision N (m) Short/Open, Part No. 22N50
- Anritsu Precision N (f) Short/Open, Part No. 22NF50
- Site Master Precision N (m) Load, 42 dB, Part No. SM/PL
- Site Master Precision N (f) Load, 42 dB, Part No. SM/PLNF
- 7/16 (m) Precision Open/Short/Load, Part No. 2000-767
- 7/16 (f) Precision Open/Short/Load, Part No. 2000-768
- Adapter, Precision N (m) to N (m), Part No. 34NN50A

## ***Chapter 1 General Information***

---

- Adapter, Precision N (f) to N (f), Part No. 34NFN50
- Adapter, 7/16 (f) to N (m), Part No. 510-90
- Adapter, 7/16 (f) to N (f), Part No. 510-91
- Adapter, 7/16 (m) to N (m), Part No. 510-92
- Adapter, 7/16 (m) to N (f), Part No. 510-93
- Adapter, 7/16 DIN (m) to 7/16 DIN (m), Part No. 510-96
- Adapter, 7/16 DIN (f) to 7/16 DIN (f), Part No. 510-97
- Armoured Test Port Extension Cable, 1.5 meter, N (m) to N (f), Part No. 15NNF50-1.5A
- Armoured Test Port Extension Cable, 3.0 meter, N (m) to N (f), Part No. 15NNF50-3.0A
- Armoured Test Port Extension Cable, 5.0 meter, N (m) to N (f), Part No. 15NNF50-5.0A
- Armoured Test Port Extension Cable, 1.5 meter, N (m) to N (m), Part No. 15NN50-1.5A
- Armoured Test Port Extension Cable, 3.0 meter, N (m) to N (m), Part No. 15NN50-3.0A
- Armoured Test Port Extension Cable, 5.0 meter, N (m) to N (m), Part No. 15NN50-5.0A
- Armoured Test Port Extension Cable, 1.5 meter, N (m) to 7/16 DIN (f), Part No. 15NDF50-1.5A
- Armoured Test Port Extension Cable, 1.5 meter, N (m) to 7/16 DIN (m), Part No. 15ND50-1.5A
- RF Detector, 1 to 3000 MHz, N(m) input connector, 50 Ohms, Part No. 5400-71N50

---

*Chapter 1 General Information*

- Transit Case for Site Master, Part No. 760-215
- HP Deskjet 340 Printer, Part No. 2000-766
- Serial-to-Parallel Converter Cable (use with the HP 340 Printer), Part No. 2000-753
- Seiko DPU-414 Thermal Printer, Part No. 2000-754 (U.S.) or 2000-761 (Europe)
- US Adapter (use with the DPU-414 Printer), Part No. 2000-1002
- Europe Adapter (use with the DPU-414 Printer) Part No. 2000-1003
- Battery Pack (use with the DPU-414 Printer) Part No. 2000-1004
- Serial Interface Cable (use with the DPU-411 Printer), Part No. 2000-XXX
- Thermal Paper (use with the DPU-411/DPU-414 Printer), Part No. 2000-755

## **Performance Specifications**

Performance specifications are provided in Table 1-1, on the following page.

**Chapter 1 General Information**

---

*Table 1-1. Performance Specifications (1 of 2)*

*Specifications are valid when the unit is calibrated at ambient temperature after a 5 minute warmup.*



<u>Description</u>	<u>Value</u>
Frequency Range:	625 to 2500 MHz
Frequency Accuracy (RF Source Mode)	75 parts per million @ 25°C*
Frequency Resolution	100 kHz
SWR:	
Range	1.00 to 65.00
Resolution	0.01
Return Loss:	
Range	0.0 to 54.00 dB
Resolution	0.01 dB
Cable Insertion Loss:	
Range	0.0 to 54.00 dB
Resolution	0.01 dB
Insertion Loss/Gain:	
Range	-120.0 to 100.0 dB
Resolution	0.01 dB
**Distance-To-Fault (DTF):	
Range	0 to (Resolution x 129)
Resolution (in meters) (Rectangular Windowing)	$\frac{(1.5 \times 10^8)(V_f)}{\Delta Frequency}$
	Where $V_f$ is the cable's relative propagation velocity.
Bias Tee:	
Input Voltage	12.5 - 15 Vdc
Output Current	200 mA max

---

**Chapter 1 General Information**

---

*Table 1-1. Performance Specifications (2 of 2)*

---

Wattmeter Power Monitor:	
Range	–50.0 to +20 dBm <i>or</i> 10.0 nW to 100.0 mW
Offset Range	0 to +60.0 dB
Resolution	0.1 dB <i>or</i> 0.1 xW
Test Port, Type N	50 Ohms
***Immunity to Interfering signals up to the level of	+10 dBm, Reflection +30 dBc, Transmission
Maximum Input (Damage Level):	
Test Port, Type N	+22 dBm
RF Detector	+20 dBm
Measurement Accuracy: Measurement accuracy depends on calibration components. Precision calibration components have a directivity of 42 dB.	
Temperature:	
Storage	–20° C to 75° C
Operation	0° C to 50° C
Weight:	3.0 pounds (1.36 kg)
Size:	8 x 7 x 2¼ inches (203.2 x 177.8 x 57.2 mm)

---

$\pm 2$  ppm/ $\Delta^{\circ}$ C from 25°C

\*\* Fault location is accomplished by inverse Fourier Transformation of data taken with the **Site Master**. Resolution and maximum range depend on the number of frequency data points, frequency sweep range and relative propagation velocity of the cable being tested.

\*\*\* Immunity measurement is made in CW mode with incoming interfering signal exactly at the same frequency (worst case situation). Typical immunity is better when swept frequency is used.

---

## Preventive Maintenance

**Site Master** preventive maintenance consists of cleaning the unit and inspecting and cleaning the RF connectors on the instrument and all accessories.

Clean the **Site Master** with a soft, lint-free cloth dampened with water or water and a mild cleaning solution.

**CAUTION:** *To avoid damaging the display or case, do not use solvents or abrasive cleaners.*

Clean the RF connectors and center pins with a cotton swab dampened with denatured alcohol. Visually inspect the connectors. The fingers of the N (f) connectors and the pins of the N(m) connectors should be unbroken and uniform in appearance. If you are unsure whether the connectors are good, gauge the connectors to confirm that their dimensions are correct.

Visually inspect the test port cable(s). The test port cable should be uniform in appearance, not stretched, kinked, dented, or broken.



## Calibration

The **Site Master** is a field portable unit operating in the rigors of the test environment. An Open-Short-Load (OSL) calibration should be performed prior to making a measurement in the field. A built-in temperature sensor in the **Site Master** advises the user, via an icon located on the left side of the LCD screen, that the internal temperature has exceeded a safety window, and the user is advised to perform another OSL calibration in order to maintain the integrity of the measurement.



**NOTES:**

*For best calibration results—compensation for all measurement uncertainties—ensure that the Open/Short/Load is at the end of the test port or optional extension cable; that is, at the same point that you will connect the antenna or device to be tested.*

*For best results, use a phase stable Test Port Extension Cable (see Optional Accessories). If you use a typical laboratory cable to extend the **Site Master** test port to the device under test, cable bending subsequent to the OSL calibration will cause uncompensated phase reflections inside the cable. Thus, cables which are **NOT** phase stable may cause measurement errors that are more pronounced as the test frequency increases.*

*For optimum calibration, Anritsu recommends using precision calibration components.*

## **Annual Verification**

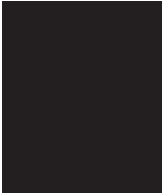

Anritsu recommends an annual calibration and performance verification of the **Site Master** and the OSL calibration components by local Anritsu service centers. Anritsu service centers are listed in Table 1-2 beginning on the following page.

The **Site Master** itself is “self calibrating”, meaning that there are no field-adjustable components. However, the OSL calibration components are crucial to the integrity of the calibration and therefore, must be verified periodically to ensure performance conformity. This is especially important is the OSL calibration components have been accidentally dropped or over-torqued.

---

**Chapter 1 General Information**

---

*Table 1-2. Anritsu Service Centers (1 of 2)*

---

**UNITED STATES**

ANRITSU COMPANY  
685 Jarvis Drive  
Morgan Hill, CA 95037-2809  
Telephone: (408) 776-8300  
FAX: 408-776-1744

ANRITSU COMPANY

10 Kingsbridge Road  
Fairfield, NJ 07004  
Telephone: (201) 227-8999  
FAX: 201-575-0092

**AUSTRALIA**

ANRITSU PTY. LTD.  
Unit 3, 170 Foster Road  
Mt. Waverley, VIC 3149  
Australia  
Telephone: 03-9558-8177  
Fax: 03-9558-8255

**BRAZIL**

ANRITSU ELECTRONICA LTDA.  
Praia de Botafogo 440, Sala 2401  
CEP 22250-040, Rio de Janeiro, RJ, Brasil  
Telephone: 021-28-69-141  
Fax: 021-53-71-456

**CANADA**

ANRITSU INSTRUMENTS LTD.  
215 Stafford Road, Unit 102  
Nepean, Ontario K2H 9C1  
Telephone: (613) 828-4090  
FAX: (613) 828-5400

**CHINA**

ANRITSU BEIJING SERVICE CENTER  
Beijing Fortune Building  
416W, 5 Dong San Huan Bei Lu  
Chaoyang qu  
Beijing 100004, China  
Telephone: 011861065909237  
FAX: 011861065909236

**FRANCE**

ANRITSU S.A  
9 Avenue du Quebec  
Zone de Courtaboeuf  
91951 Les Ulis Cedex  
Telephone: 016-44-66-546  
FAX: 016-44-61-065

**GERMANY**

ANRITSU GmbH  
Grafenberger Allee 54-56  
D-40237 Dusseldorf  
Germany  
Telephone: 0211-96 85 50  
FAX: 0211-96 85 555

**INDIA**

MEERA AGENCIES (P) LTD  
A-23 Hauz Khas  
New Delhi 110 016  
Telephone: 011-685-3959  
FAX: 011-686-6720



## **Chapter 1 General Information**

---

*Table 1-2. Anritsu Service Centers (2 of 2)*

---

### **ISRAEL**

TECH-CENT, LTD  
Haarad St. No. 7, Ramat Haahayal  
Tel-Aviv 69701  
Telephone: (03) 64-78-563  
FAX: (03) 64-78-334

### **ITALY**

ANRITSU Sp.A  
Rome Office  
Via E. Vittorini, 129  
00144 Roma EUR  
Telephone: (06) 50-22-666  
FAX: (06) 50-22-4252

### **JAPAN**

ANRITSU CORPORATION  
1800 Onna Atsugi-shi  
Kanagawa-Prf. 243 Japan  
Telephone: 0462-23-1111  
FAX: 0462-25-8379

### **KOREA**

ANRITSU KOREA (AWK)  
#901 Daeo Bldg. 26-5  
Yeoido Dong, Youngdeungpo  
Seoul Korea 150 010  
Telephone: 02-782-7156  
FAX: 02-782-4590

### **SINGAPORE**

ANRITSU (SINGAPORE) PTE LTD  
3 Shenton Way #24-03  
Shenton House  
Singapore 0106  
Telephone: 022-65-206  
FAX: 022-65-207

### **SOUTH AFRICA**

ETESCSA  
1st Floor Montrose Place  
Waterfall Park, Becker Road  
MIDRAND  
SOUTH AFRICA  
Telephone: 011-315-1366  
Fax: 011-315-2175

### **SWEDEN**

ANRITSU AB  
Botvid Center  
S-145 84  
Stockholm, Sweden  
Telephone: (08) 534-717-00  
FAX: (08)534-717-30

### **TAIWAN**

ANRITSU CO., LTD.  
8F, No. 96, Section 3  
Chien Kuo N. Road  
Taipei, Taiwan, R.O.C.  
Telephone: (02) 515-6050  
FAX: (02) 509-5519

### **UNITED KINGDOM**

ANRITSU LTD.  
200 Capability Green  
Luton, Bedfordshire  
LU1 3LU, England  
Telephone: 015-82-41-88-53  
FAX: 015-82-31-303

---



This page intentionally blank.

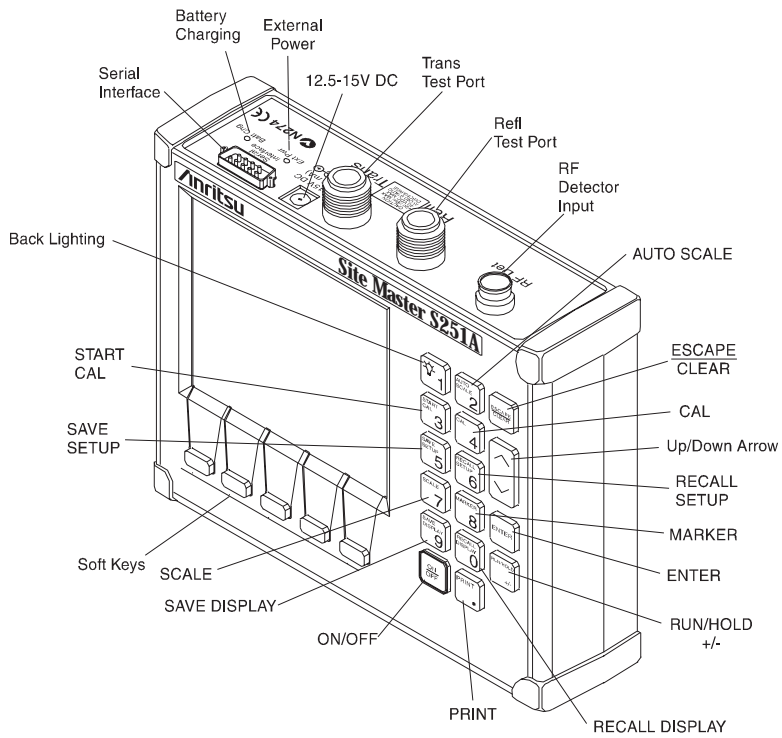

Figure 2-1. *Site Master Controls and Connectors*

**2 - 0**

# Chapter 2

## Connectors and Controls

### Introduction

This chapter provides a description of each **Site Master** control and connector. In addition, this chapter contains listings of the LCD icon symbols and error messages and instructions for printing a screen.



### Test Panel Connectors

The connectors and indicators located on the test panel are listed and described below.

**12.5-15VDC (600 mA)** Provides input for battery charging the unit. Input is 12.5 to 15 Vdc @ 600 mA.

**Battery Charging** Indicator light to show that the battery is being charged. (Indicator automatically shuts off when the battery is fully charged.)

**External Power** Indicator light to show that the **Site Master** is being powered by the external charging unit.

**Serial Interface** Provides an RS232 DB9 interface with a Com Port on a personal computer (for use with the Anritsu

## Chapter 2 Connectors and Controls

---

Software Tools program). Also provides an interface to a HP Deskjet 340 printer or a Seiko DPU-411/DPU-414 Thermal printer.

**Refl Test Port** Provides RF output, 50Ω impedance.

**Trans Test Port** Provides RF input, 50Ω impedance.

**RF Det** Provides RF detector input for the Power Monitor.

## Keypad Controls

The next five pages contains an alphabetical listing of the **Site Master** front panel keypad controls along with a brief description of each.



Turns the liquid crystal display (LCD) back-lighting ON or OFF. (Leaving back lighting off conserves battery power.)

**AUTO SCALE** Automatically scales the display for optimum resolution.

**CAL** Displays the calibration configuration—the type of calibration, the frequency range, the valid temperature range of the calibration, and the current temperature.

**ENTER** Implements certain menu and key selections.



<b><u>ESCAPE</u> CLEAR</b>	Exits the present operation and/or clears the display. If a parameter is being edited, pressing this key will clear the value currently being entered and restore the last valid entry. Pressing this key again will close the parameter. During normal sweeping, pressing this key will move up one menu level.
<b>MARKER</b>	Calls up the Markers Menu, described on page 2-23.
<b><u>ON</u> OFF</b>	Turns the <b>Site Master</b> on or off. When turned on, the system state at the last turn-off is restored. If the <b>ESCAPE/CLEAR</b> key is held down, the factory preset state is restored.
<b>PRINT</b>	Prints the current display to the selected printer.
<b>RECALL DISPLAY</b>	Recalls a previously saved trace from memory location 1 through 50. When the key is pressed, "Recall display:" appears on the display. Select an appropriate number from the keypad and press the <b>ENTER</b> key to implement.
<b>RECALL SETUP</b>	Recalls a previously saved setup from memory location 0 through 4. When the key is pressed, "Recall Setup:" appears on the display. Select an appropriate number using the <b>Up/Down Arrow</b> key and press the <b>ENTER</b> key to implement. Setup 0 recalls the factory preset state.
<b><u>RUN</u> HOLD</b>	When in the Hold mode, this key starts the <b>Site Master</b> sweeping and provides a Single Sweep Mode trigger; when in the Run mode, it pauses the sweep.

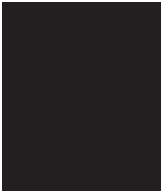

## Chapter 2 Connectors and Controls

---

When in the Hold mode, the hold symbol (Table 2-1, page 2-30) appears on the left side of the LCD. (HOLD conserves considerable battery power.)

**+/-** When in the Gain/Insertion Loss measurement mode, the +/- key is used in conjunction with the Scale Menu to toggle the top, bottom, and limit numerical value sign. A negative numeric value is generated by pressing the +/- key after the number is entered.



### SAVE DISPLAY

Saves the displayed trace to 1 of 50 internal non-volatile memory locations. When the key is pressed, the next available empty memory location appears on the display (i.e. "Save display 3"). Press **ENTER** to save to the current empty memory location or select an appropriate number from the keypad or use the **Up/Down Arrow** key and press the **ENTER** key to implement. Use the keypad or the **Up/Down Arrow** key to manually enter the Time, Date, and Trace Designator for each saved display.

To erase saved displays select 0 and press **ENTER**. Individual displays may be selected and erased by entering the display number and pressing **ENTER**. Selecting display 0 will erase all saved displays.

**CAUTION:** *The selected memory location will be overwritten by the SAVE DISPLAY operation. No warning is given.*

**SAVE SETUP** Saves the current system setup to 1 of 4 internal non-volatile memory locations. When the key is pressed, "Save Setup:" appears on the display. Select an appropriate number using the Up/Down Arrow key and press the **ENTER** key to implement.

**CAUTION:** *The selected memory location will be overwritten by the SAVE SETUP operation. No warning is given.*

**SCALE** Calls up the Scale Menu, described on page 2-14.

**START CAL** Follow the text in the message area that instructs you to do the following:

- Connect OPEN to REFL port, Press ENTER  
The **Site Master** then measures the calibration "open" that you must attach to the end of the Refl test port.
- Connect SHORT to REFL port, Press ENTER  
The **Site Master** then measures the calibration "short" that you must attach to the end of the Refl test port.
- Connect LOAD to REFL port, Press ENTER  
The **Site Master** then measures the 50Ω termination (load) that you must attach to the end of the Refl test port.



## Chapter 2 Connectors and Controls

---

- ❑ Connect LOAD to REFL and TRANS ports, press ENTER  
The **Site Master** then measures the isolation (50Ω termination load) that you must attach to the end of the Refl test port and the Trans test port.
- ❑ Connect REFL port to TRANS port, Press ENTER  
The **Site Master** then measures the through "transmission" that you must attach from the Refl test port to the Trans test port.



**NOTE:**

*The combined measurements of an open, a short, a known-impedance load, a through, and an isolation normalizes the measurement system, to account for uncertainties introduced by measurement-system components (e.g., cables, connectors, etc.).*

**Up/Down Arrow Key** Increments or decrements a parameter value.

**NOTE:**

*At turn on, before any other keys are pressed, the Up/Down Arrow Key may be used to adjust display contrast.*

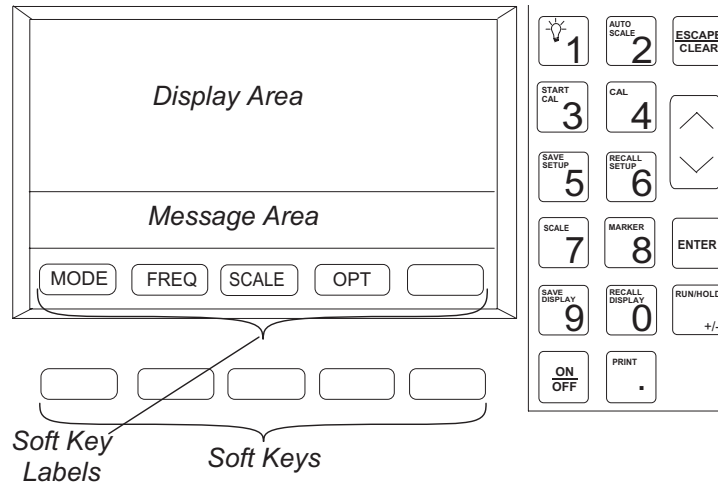

Figure 2-2. Site Master Front Panel Display Layout

## Soft Keys and Menus

Each of the soft keys has a corresponding soft key label area on the display. The label identifies the function of the soft key for the current menu selection.

Figure 2-3, on the following page, shows the menu structure, the soft key labels for each menu selection, and the page where a description of the menu can be found.

## Chapter 2 Connectors and Controls

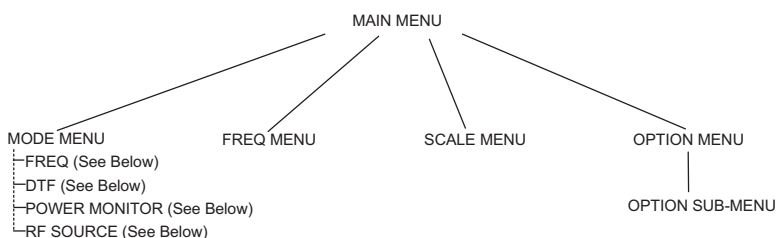

MODE	MENU TITLE	SOFT KEY LABELS	PAGE
FREQ (Default Mode)	MAIN MENU	[MODE] [FREQ] [SCALE] [OPT] [ ]	2-9
	FREQUENCY MENU	[F1] [F2] [ ] [ ] [MAIN]	2-13
	SCALE MENU	[TOP] [BOTTOM] [LIMIT] [ ] [MAIN]	2-14
	OPTION MENU	[B1] [B2] [B3] [B4] [MORE]	2-15
	OPTION SUB-MENU	[B5] [B6] [B7] [B8] [MAIN]	2-16
DTF	MAIN MENU	[MODE] [DIST] [SCALE] [OPT] [ ]	2-10
	DISTANCE MENU	[D1] [D2] [DTF AID] [ ] [MORE]	2-17
	DISTANCE SUB-MENU	[LOSS] [PROP V] [CABLE] [WINDOW] [MAIN]	2-18
	SCALE MENU	[TOP] [BOTTOM] [LIMIT] [ ] [MAIN]	2-14
	OPTION MENU	[B1] [B2] [B3] [B4] [MORE]	2-15
OPTION SUB-MENU	[B5] [B6] [B7] [B8] [MAIN]	2-16	
POWER MONITOR	MAIN MENU	[UNITS] [REL] [OFFSET] [ZERO] [MAIN]	2-11
RF SOURCE	MAIN MENU	[FREQ] [POWER] [ ] [ ] [MAIN]	2-12

Figure 2-3. Site Master Menu Structure

**Main Menu** At turn on, the Main Menu soft keys, below, are displayed, and the Marker status is shown in the message area.



These soft keys provide the following menu selections:

- ❑ **MODE** — Selects the type of measurement. Use the **Up/Down Arrow** key and the **ENTER** key to select the type of measurement in the **FREQ**, **DTF**, **POWER MONITOR**, and **RF SOURCE** measurement modes.
- ❑ **FREQ** — Selects the Frequency Menu, described on page 2-13.
- ❑ **SCALE** — Selects the Scale Menu, described on page 2-14.
- ❑ **OPT** — Selects the Option Menu, described on page 2-15.



**DTF** When the DTF measurement mode is selected, the  
**Main Menu** Main Menu soft keys, below, are displayed, and the  
Marker status is shown in the message area.



These soft keys provide the following menu selections:

- **MODE** — Selects the type of measurement. Use the **Up/Down Arrow** key and **ENTER** key to select the type of measurement in the **FREQ**, **DTF**, and **POWER MONITOR** measurement modes.
- **DIST** — Selects the Distance Menu, described on page 2-17.
- **SCALE** — Selects the Scale Menu, described on page 2-14.
- **OPT** — Selects the Option Menu, described on page 2-15.





**Power Monitor Main Menu** When the Power Monitor measurement mode is selected, the Main Menu soft keys, below, are displayed, and the units, relative, offset, and zero adjust status are shown in the message area.



- **UNITS**— Toggles between dBm and Watts.
- **REL**— Turns relative mode OFF, if currently ON. If relative mode is currently OFF, turns it ON and causes the power level to be measured and saved as the base level. Subsequent measurements are then displayed relative to this saved value. With units of dBm, relative mode displays dB<sub>r</sub>; with units of Watts, relative mode displays % (percent).
- **OFFSET**— Turns Offset OFF, if currently ON. If Offset is currently OFF, turns it ON and opens the Offset parameter for data entry. Press **ENTER** when data entry is complete. Offset is the attenuation (in dB) inserted in the line between the DUT and the RF detector. The attenuation is added to the measured input level prior to display.
- **ZERO**— Turns Zero OFF, if currently ON. If Zero is currently OFF, turns it ON and initiates collection of a series of power level samples, which are averaged and saved. This saved value is then subtracted from subsequent measurements prior to display.



- **MAIN**— Returns to the Main Menu.

**RF Source Main Menu** When the RF Source measurement mode is selected, the Main Menu soft keys, below, are displayed and the frequency is shown in the message area.



- **FREQ**— Opens the RF source frequency parameter for data entry. Press **ENTER** when data entry is complete.
- **POWER**— Toggles the RF source power between +6 dBm and -30 dBm.
- **MAIN**— Returns to the Main Menu.



**Frequency Menu (FREQ)** Provides for setting sweep frequency end-points. Selected frequency values may be changed using the keypad or **Up/Down Arrow** key.

Choosing **FREQ** causes the soft keys, below, to be displayed and the corresponding values to be shown in the message area.



- **F1** — Opens the F1 parameter for data entry. This is the start value for the frequency sweep. Press **ENTER** when data entry is complete.
- **F2** — Opens the F2 parameter for data entry. This is the stop value for the frequency sweep. Press **ENTER** when data entry is complete.
- **MAIN** — Returns to the Main Menu.



**Scale Menu (SCALE)** Provides for changing the display scale. Selected values may be changed using the **Up/Down Arrow** key or keypad.

Choosing **SCALE** causes the soft keys, below, to be displayed and the corresponding values to be shown in the message area.

Pressing the **SCALE** key on the keypad will also call up this menu.



- **TOP** — Opens the TOP parameter for data entry and provides for setting the top scale value. Press **ENTER** when data entry is complete.
- **BOTTOM** — Opens the BOTTOM parameter for data entry and provides for setting the bottom scale value. Press **ENTER** when data entry is complete.
- **LIMIT** — Turns Limit OFF, if currently ON. If Limit is currently OFF, turns it ON and opens the Limit parameter for data entry. Press **ENTER** when data entry is complete.
- **MAIN** — Returns to the Main Menu.

**Option  
Menu  
(OPT)**

Provides for selecting **Site Master** options.

Choosing **[OPT]** causes the soft keys, below, to be displayed and the corresponding values to be shown in the message area.



- ❑ **[B1]** MATH — Opens a menu of trace math operation modes; OFF, TRACE + MEMORY, TRACE – MEMORY, TRACE ÷ 2. Use the Up/Down Arrow key and **[ENTER]** key to make a selection.
- ❑ **[B2]** LIMIT BEEP ON/OFF — Toggles the limit beeping sound on or off. When on, the **Site Master** sounds a beep when the measured value is above the limit line.
- ❑ **[B3]** BIAS TEE ON/OFF — Toggles the bias tee option on or off. External power must be connected to the battery charging port to activate the bias tee function. When on, the bias tee voltage and current are displayed.
- ❑ **[B4]** SINGLE SWP ON/ OFF — Toggles the single sweep function on or off. When on, the **Site Master** will have to be manually triggered using the **[RUN/HOLD]** key on the keypad for each sweep.
- ❑ **[MORE]** — Selects the Option Sub-Menu, described on page 2-16.



**Option  
Sub-Menu**

Provides for selecting additional **Site Master** options.

Choosing **[MORE]** causes the soft keys, below, to be displayed and the corresponding values to be shown in the message area.



- [B5] UNITS** — Toggles between ENGLISH and METRIC units.
- [B6] FIXED CW** — Toggles the fixed CW mode on or off.
- [B7] PRINTER** — Displays a menu of supported printers—None, Seiko DPU-411, Seiko DPU-414, and HP Deskjet 340. Use the **[Up/Down Arrow]** key and **[ENTER]** key to make the selection.
- [B8] CONTRAST** — Enables adjustment of the LCD contrast. Use the **[Up/Down Arrow]** key and **[ENTER]** key to set the contrast.
- [MAIN]** — Returns to the Main Menu.



**Distance Menu (DIST)**

Provides for setting Distance to Fault parameters. Selected distance values may be changed using the keypad or **[Up/Down Arrow]** key. Entry can be in feet or meters, depending on the setting of the **[B5]** soft key in the Option Sub-Menu (page 2-16).

Choosing **[DIST]** causes the soft keys, below, to be displayed and the corresponding values to be shown in the message area.



- ❑ **[D1]**— Opens the start distance (D1) parameter for data entry. This is the start value for the distance range. Press **[ENTER]** when data entry is complete.
- ❑ **[D2]**— Opens the end distance (D2) parameter for data entry. This is the end value for the distance range. Press **[ENTER]** when data entry is complete.
- ❑ **[DTF AID]**— Provides interactive help to optimize DTF set up parameters. User is prompted for system parameter values of maximum distance, center frequency, cable type, or propagation velocity. Frequency parameters are then calculated to optimize both range and resolution.
- ❑ **[MORE]**— Selects the Distance Sub-Menu, described on page 2-18.



*NOTE: Refer to Appendix A for a listing of common coaxial cables showing values for "Relative Propagation Velocity" and "Nominal Attenuation in dB/m @ 1000 MHz".*

**Distance Sub-Menu** Provides for setting the cable loss and relative propagation velocity of the coaxial cable. Selected values may be changed using the **Up/Down Arrow** key or keypad.

Choosing **MORE** causes the soft keys, below, to be displayed and the corresponding values to be shown in the message area.

**LOSS** **PROP V** **CABLE** **WINDW** **MAIN**

- **LOSS** — Opens the Cable Loss parameter for data entry. Enter the loss per foot (or meter) for the type of transmission line being tested. Press **ENTER** when data entry is complete. (Range is 0.000 to 5.000 dB/m or 0.000 to 1.000 dB/ft)
- **PROP V** (relative propagation velocity) — Opens the Propagation Velocity parameter for data entry. Enter the propagation velocity for the type of transmission line being tested. Press **ENTER** when data entry is complete. (Range is 0.010 to 1.000)



- **CABLE**— Opens a cable folder containing a standard cable list and a custom cable list. Use the **Up/Down Arrow** key and **ENTER** key to select either the standard cable list or custom cable list. Then, use the **Up/Down Arrow** key and **ENTER** key to make a cable selection from the selected list. This feature provides a rapid means of setting both cable loss and propagation velocity.

*NOTE: Standard cable loss is specified at 1000 MHz.*

*The custom cable list must be downloaded via the "cable download" program supplied.*



## Chapter 2 Connectors and Controls

---

- **WINDW**— Opens a menu of FFT windowing types for the DTF calculation. Scroll the menu using the **Up/Down Arrow** key and make a selection with the **ENTER** key.

**NOTE: Using Windowing**

*The theoretical requirement for inverse FFT is for the data to extend from zero frequency to infinity. Side lobes appear around a discontinuity due to the fact that the spectrum is cut off at a finite frequency. Windowing reduces the side lobes by smoothing out the sharp transitions at the beginning and end of the frequency sweep. As the side lobes are reduced the main lobe widens thereby reducing the resolution.*

*In situations where there may be a small discontinuity close to a large one, side lobe reduction Windowing should be used. When distance resolution is critical Windowing can be reduced. The types of Windowing in order of increasing side lobe reduction are: rectangular, nominal side lobe, low side lobe, minimum side lobe. Figures 2-4 thru 2-7, on pages 2-21 and 2-22, are examples of the types of Windowing.*

- **MAIN**— Returns to the Main Menu.

*Chapter 2 Connectors and Controls*

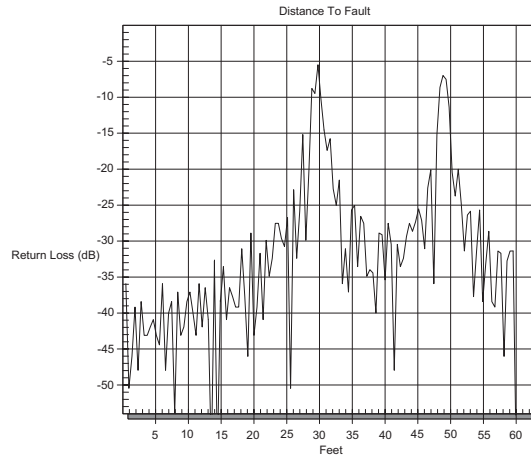

*Figure 2-4. Rectangular Windowing Example*

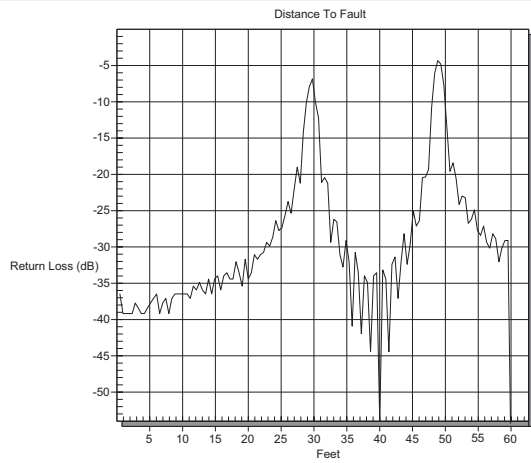

*Figure 2-5. Nominal Side Lobe Windowing Example*

*Chapter 2 Connectors and Controls*

---

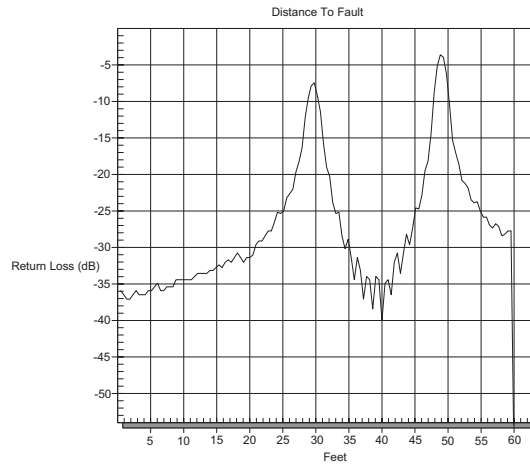

*Figure 2-6. Low Side Lobe Windowing Example*

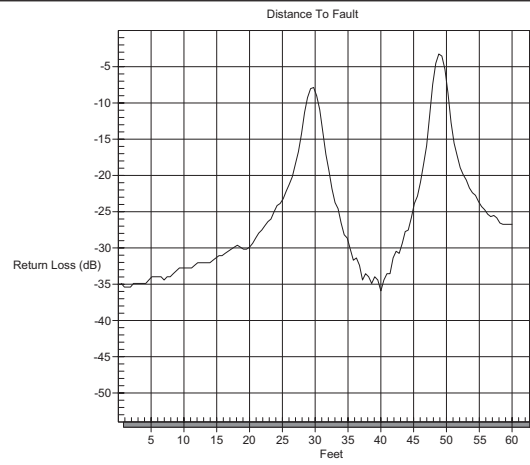
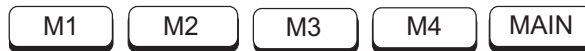

*Figure 2-7. Minimum Side Lobe Windowing Example*

**Markers Menu**

Provides for setting marker values. Selected frequency marker or distance marker values may be changed using the keypad or **Up/Down Arrow** key.

Pressing the **MARKER** key causes the soft keys, below, to be displayed and the corresponding values to be shown in the message area.



- ❑ **M1** — Selects the M1 marker parameter, displaying either frequency or distance and the corresponding SWR, RL, CL, or IL/IG, and opens the Markers 2nd Level Menu, described on page 2-24.
- ❑ **M2** — Selects the M2 marker parameter, displaying either frequency or distance and the corresponding SWR, RL, CL, or IL/IG, and opens the Markers 2nd Level Menu, described on page 2-24.
- ❑ **M3** — Selects the M3 marker parameter, displaying either frequency or distance and the corresponding SWR, RL, CL, or IL/IG, and opens the Markers 2nd Level Menu, described on page 2-24.
- ❑ **M4** — Selects the M4 marker parameter, displaying either frequency or distance and the corresponding SWR, RL, CL, or IL/IG, and opens the Markers 2nd Level Menu, described on page 2-24.
- ❑ **MAIN** — Returns to the Main Menu.



**Markers Menu (2nd Level)** Provides for turning the selected marker on and off and for setting marker values. Selected frequency marker and distance marker values can be changed using the keypad or **Up/Down Arrow** key.

Choosing **M1** causes the soft keys, below, to be displayed and the corresponding values to be shown in the message area.

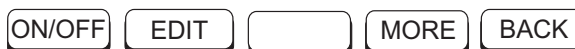

Choosing **M2**, **M3**, or **M4** causes the soft keys, below, to be displayed and the corresponding values to be shown in the message area.



- **ON/OFF** — Turns the selected marker on or off.
- **EDIT** — Opens the selected marker parameter for data entry. Press **ENTER** when data entry is complete.
- **DELTA** — Displays delta SWR, RL, CL, or IL/IG as well as delta frequency or distance for the selected marker with respect to the M1 marker.
- **MORE** — Selects the Markers 3rd Level Menu, described on page 2-25.
- **BACK** — Returns to Main Markers Menu.

**Markers Menu (3rd Level)** Provides selections for placing the selected marker at the frequency or distance with the maximum or minimum SWR, RL CL, or IL/IG.

Choosing **MORE** causes the soft keys, below, to be displayed and the corresponding values to be shown in the message area.



- **PEAK**— Places the selected marker at the frequency or distance with the maximum SWR, RL, CL, or IL/IG. Each time the **PEAK** soft key is pressed, the marker will find the next peak value. Up to 5 consecutive peak values can be selected.
- **VALLEY**— Places the selected marker at the frequency or distance with the minimum SWR, RL, CL, or IL/IG.
- **BACK**— Returns to the Markers 2nd Level Menu.
- **MKRS**— Returns to the Main Markers Menu.



## Determining Remaining Battery Life

When the AC-DC adapter is disengaged from the **Site Master**, a battery indicator symbol is continuously displayed at the top-right corner of the display (Figure 2-8). A totally black bar indicates a fully charged battery.

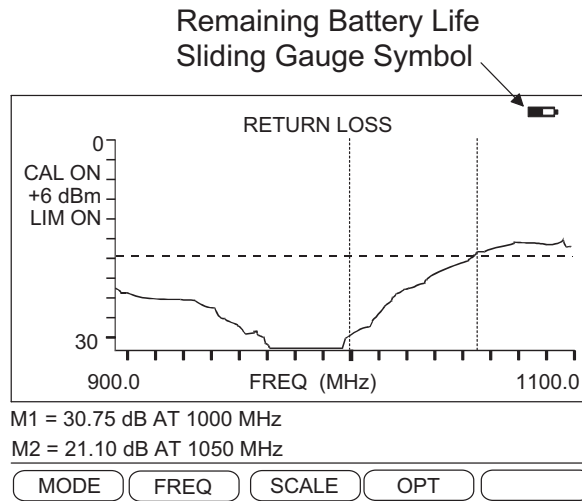

Figure 2-8. Battery Monitor



## Printing

Printing is accomplished with any of the following printers: the Seiko DPU-411 thermal printer, the Seiko DPU-414 thermal printer, or the Hewlett Packard DeskJet 340 ink jet printer. Figure 2-9 shows a setup diagram for these two types of printers.

### Printer Switch Settings

Set the switches, SW1 and SW2, on the Seiko DPU-411 thermal printer as follows:

<u>Switch</u>	<u>1</u>	<u>2</u>	<u>3</u>	<u>4</u>	<u>5</u>	<u>6</u>	<u>7</u>	<u>8</u>
SW1	OFF	ON	ON	ON	ON	OFF	ON	ON
SW2	ON	ON	ON	OFF	OFF	OFF		

Set the switches, SW1, SW2, and SW3, on the Seiko DPU-414 thermal printer as follows:

<u>Switch</u>	<u>1</u>	<u>2</u>	<u>3</u>	<u>4</u>	<u>5</u>	<u>6</u>	<u>7</u>	<u>8</u>
SW1	OFF	ON	ON	ON	ON	OFF	ON	ON
SW2	ON	ON	ON	ON	ON	ON	ON	OFF
SW3	ON	ON	ON	OFF	OFF	ON	ON	ON

Set the switches on the serial-to-parallel interface cable to the HP Desk-jet 340 ink jet printer as follows:

<u>SW1</u>	<u>SW2</u>	<u>SW3</u>	<u>SW4</u>	<u>SW5</u>	<u>SW6</u>	<u>SW7</u>	<u>SW8</u>
OFF	ON	OFF	OFF	OFF	OFF	OFF	OFF

### Printing a Screen

- Step 1. Connect the printer as shown in Figure 2-9.
- Step 2. Obtain a SWR, RL, CL, Insertion Loss/Insertion Gain, or Distance-to-Fault measurement display.
- Step 3. Select the printer using the **B7** soft key from the Option Sub-Menu (page 2-16).
- Step 4. Press the **PRINT** key (Figure 2-1, page 2-0).

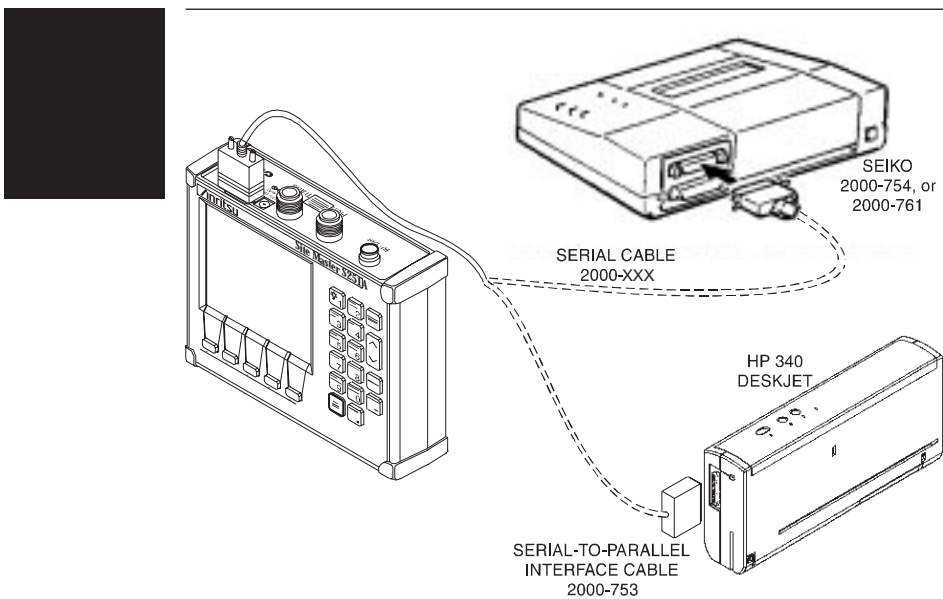

Figure 2-9. Printer Setup

## **Symbols**

Table 2-1 provides a listing of the symbols used as condition indicators on the LCD display.

## **Self Test**

At turn-on, the **Site Master** runs through a series of quick checks to ensure the system is functioning properly. Note that the battery voltage and temperature are displayed in the lower left corner below the self test message. If the battery is low, or if the ambient temperature is not within the specified operational range, Self Test will fail. If Self Test fails AND the battery is fully charged AND the **Site Master** is within the specified operating range, call your Anritsu Service Center.



## **Error Codes**

### **Self Test Errors**

A listing of Self Test Error messages is given in Table 2-2.

### **Range Errors**

A listing of Range Error messages is given in Table 2-3.

## **Replacing the Battery**







Replacing the battery is the only recommended field-level maintenance action. If your battery fails, contact your Anritsu Sales Office or Service Center. Table 1-2 (page 2-11) provides a listing of current service centers.

## Chapter 2 Connectors and Controls

---

Table 2-1. LCD Icon Symbols

---

<u>Icon</u>	<u>Symbol</u>
	<b>Site Master</b> is in Hold or Power Conservation mode. To resume sweeping, press the <b>RUN/HOLD</b> key. After 10 minutes without a key press, the <b>Site Master</b> will automatically enter into its power conservation mode.
	Indicates internal data processing.
	Lock fail indication. Check battery. (If <b>Site Master</b> fails to lock with a fully charged battery, call your Anritsu Service Center.)
	Processor timeout failure. Symbol appears at the frequency that causes an input RF overload; it then disappears as the sweep continues past that point.
	When calibration is performed, the <b>Site Master</b> stores the ambient temperature. If the temperature drifts outside the specified range, this indicator will flash. A recalibration at the current temperature is recommended.
	Indicates the remaining charge on the battery. The inner white rectangle grows longer as the battery charge depletes.

---

Table 2-2. Self Test Error Messages

<b>Error Message</b>	<b>Description</b>
BATTERY LOW	Battery voltage is less than 12.5 volts. Charge battery. <i>If condition persists, call your Anritsu Service Center.</i>
EXTERNAL POWER LOW	External supply voltage is less than 12.5 volts. <i>Call your Anritsu Service Center</i>
PLL FAILED	Phase-locked loops failed to lock. Charge battery. <i>If condition persists with a fully charged battery, call your Anritsu Service Center</i>
INTEGRATOR FAILED	Integration circuit could not charge to a valid level. Charge battery. <i>If condition persists with a fully charged battery, call your Anritsu Service Center.</i>
EEPROM R/W FAILED	Non-volatile memory system has failed. <i>Call your Anritsu Service Center.</i>
OUT OF TEMP. RANGE	Ambient temperature is not within the specified operating range. Return temperature to specified operating range. <i>If condition persists, call your Anritsu Service Center.</i>

*Note: A listing of current Anritsu service centers is given in Table 1-2, page 1-11.*

**Chapter 2 Connectors and Controls**

---

Table 2-3. Range Error Messages (1 of 3)

<b>Error Message</b>	<b>Description</b>
RANGE ERROR:F1 > F2	The start (F1) frequency is greater than the stop (F2) frequency.
RANGE ERROR:D1 > D2	The start (D1) distance is greater than the stop (D2) distance.
RANGE ERROR:D2 > DMax=xx.x ft (m)	<p>The stop distance (D2) exceeds the maximum unaliased range. This range is determined by the frequency span, number of points, and relative propagation velocity:</p> $\text{Maximum Unaliased Range} = \frac{(1.5 \times 10^8) (129) (V_f)}{F2 - F1}$ <p>Where: <i>F1</i> is start frequency  <i>F2</i> is stop frequency  <i>V<sub>f</sub></i> is relative propagation velocity  maximum unaliased range is in meters</p> <p>Refer to Figure A-1, page A-4, for a plot of maximum range versus frequency span.</p>
RANGE ERROR: TOP<=BOTTOM	The SWR scale parameter top value is less than or equal to its bottom value.
RANGE ERROR: TOP>=BOTTOM	The RL scale parameter top value is greater than or equal to its bottom value.
CAL INCOMPLETE	A complete open, short, and load calibration must be performed before calibration can be turned on.
CAL VALID FROM: xxxx.x to xxxx.x MHz	The calibration was performed at a frequency range that is different from the current range.

Table 2-3. Range Error Messages (2 of 3)

<u>Error Message</u>	<u>Description</u>
DIST REQUIRES F1 < F2	Valid distance to fault plots require a non-zero frequency span.
DIST REQUIRES CAL	Distance-to-fault measurements do not provide usable data with CAL OFF.
NO STORED SWEEP AT THIS LOCATION	Attempting to recall a display from a location that has not been previously written to. That is, the location does not contain stored sweep.
USE OPTIONS MENU TO SELECT A PRINTER	Attempting to print a display with no printer selected. Select a printer, then retry.
DISTANCE AND CABLE INSERTION LOSS MODE ARE INCOMPATIBLE	DTF measurements only display RL or SWR versus distance.
CANNOT ZERO NO DETECTOR INSTALLED	Attempting to perform a Power Monitor zero adjust function with no RF detector connected to the <b>Site Master</b> .
CANNOT ZERO INPUT SIGNAL TOO HIGH	Attempting to perform a Power Monitor zero adjust function with an input of greater than -20 dBm.
POWER MONITOR OPTION NOT INSTALLED	Attempting to enter Power Monitor mode with no option 5 installed.

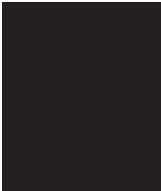

## Chapter 2 Connectors and Controls

---

Table 2-3. Range Error Messages (3 of 3)

<u>Error Message</u>	<u>Description</u>
BIAS TEE OPTION NOT INSTALLED	Attempting to use Bias Tee function without Option 10 installed.
BIAS TEE ONLY VALID WHEN EXTERNAL POWER IS ON	Attempting to use Bias Tee function without external power connected to the battery re-charger port.
EXCESS POWER DETECTED IN TRANSMISSION MODE	Exceeded power gain limit. To resolve, lower REFL output power or change the measurement mode to Insertion Gain mode and recalibrate.
TRACE/2 IS ONLY VALID IN INSERTION GAIN/LOSS MODE	Attempting to use Trace/2 Math function in incorrect mode
STORED SWEEP INCOMPATIBLE WITH CURRENT SWEEP	Attempting to do Trace Math functions with different mode sweeps.

---



## Using the Soft Carrying Case

The soft carrying case has been designed such that the strap can be un-snapped to allow the case to be easily oriented horizontally; thus allowing the Site Master controls to be more easily accessed (Figure 2-10).

---

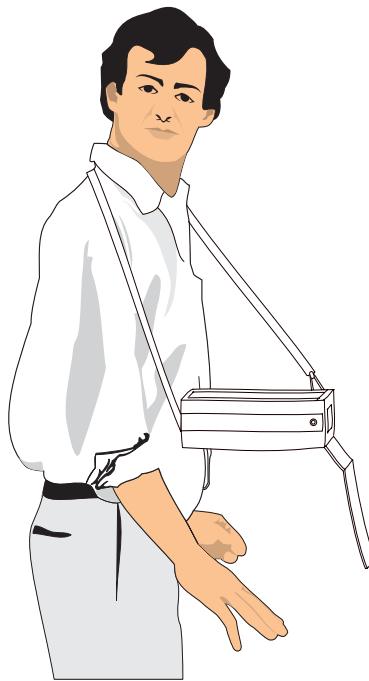

---

*Figure 2-10. Using the Soft Carrying Case*

# Chapter 3

## Operation

### Introduction

This chapter provides a description of the **Site Master** operating functions and examples of frequency domain and distance domain measurements.

### Operating Functions

**Site Master** operation is divided into five functional areas: common functions, frequency domain, distance domain, power monitor, and RF source.

- Common functions are options, markers, and scale functions that are common to both frequency domain and distance domain measurements.
- Frequency domain measurements consist of Standing Wave Ratio (SWR), Return Loss (RL), Cable Loss (CL), and Insertion Loss/Insertion Gain (IL/IG) made over a selectable frequency range. SWR and RL characterize the magnitude of reflections present in a device or transmission line. CL measurements display the insertion loss of a transmission line over frequency. IL/IG measurements display the gain or loss present in a device and/or transmission line over frequency. IL has an output power level of +6 dBm; IG has an output power level of -30 dBm.



### Chapter 3 Operation

---

- Distance domain measurements—commonly known as distance-to-fault (DTF)—are made over a selectable distance range. They include RL or SWR, but they also return information that can help locate discontinuities in a transmission line. CL cannot be measured in the distance domain.
- Power monitor measurements can be either absolute or relative to some base power level, and can be displayed in either dBm or Watts. To allow measurement and display of power levels above the unit's specified input, the user may attenuate the signal and enter the corresponding offset. The offset is added to the measured input power prior to display. Finally, a zero adjust function is provided to allow subtraction of an inherent “noise” level prior to display.
- RF source provides a selectable CW signal with +6 dBm or –30 dBm output power at the Refl port.



**CAUTION:** *The measurement system MUST be calibrated at the ambient temperature prior to making a measurement. You must calibrate when the setup frequency is changed. Calibrations and setups are not independent; they are tied together. The instrument can store up to four calibration/setups. When you recall a stored setup, perform a new calibration only if the test setup has been altered.*

## Making Common Function Selections

Common functions are options, marker, and scale functions that are common to both frequency- and distance-domain measurements.

### Applying Power

- Step 1. Turn the **Site Master** on using the **ON/OFF** key.
- Step 2. Observe that the **Site Master** opening screen appears and that it performs a self test. The firmware version and model number are shown in the opening screen.

### Setting Options

- Step 3. Press the **OPT** soft key, from the Main Menu (page 2-9).
- Step 4. Accept or change the settings of the **B1** through **B8** options. Refer to pages 2-15 and 2-16 for a description of each option.

### Setting Markers

- Step 5. Press the **MARKER** key on the keypad.
- Step 6. Accept or change the settings. To change, press the applicable **M1**, **M2**, **M3**, or **M4** soft key and:
  - Press the **ON/OFF** soft key to turn the selected marker on, if off.
  - Press the **EDIT** soft key to edit the marker. Use the keypad or **Up/Down Arrow** key to enter a numeric value. Press **ENTER** when the data entry is complete.

Refer to pages 2-23 thru 2-25 for a description of marker functions.

### **Setting Scale/Limits**

- Step 7.** Press the **SCALE** key on the keypad or the **SCALE** soft key, from the Main Menu.
- Step 8.** Accept or change the settings. To change, press the applicable **TOP**, **BOTTOM**, or **LIMIT** soft key and either:
- Enter a numeric value from the keypad and press the **ENTER** key.
  - Or press the **Up/Down Arrow** key and press the **ENTER** key.



## Return Loss (SWR) and Cable Loss (One Port) Measurement

The following frequency domain measurement is an example of a Return Loss (or Standing Wave Ratio) and Cable Loss measurement made over a selectable frequency range.

### Required Equipment

- Site Master Model S251A
- Precision Open/Short, Anritsu 22N50
- Precision Load, Anritsu SM/PL
- Test Port Extension Cable, Anritsu 15NNF50-1.5A

### Device-Under-Test Specification

Type	Typical Loss @1.5m	Vg
15NNF50-1.5A	0.40 dB @800 MHz 0.45 dB @900 MHz 0.60 dB @1710 MHz 0.70 dB @1990 MHz	0.86



### Procedure

**Step 1.** Press the **ON/OFF** key on the **Site Master**.

### Selecting the Measurement Mode

**Step 2.** Press the **MODE** soft key.

*Chapter 3 Operation*

---

**Step 3.** Use the **Up/Down Arrow** key to scroll to Return Loss (or SWR). Press the **ENTER** key to select Return Loss (or SWR) measurement mode.

---

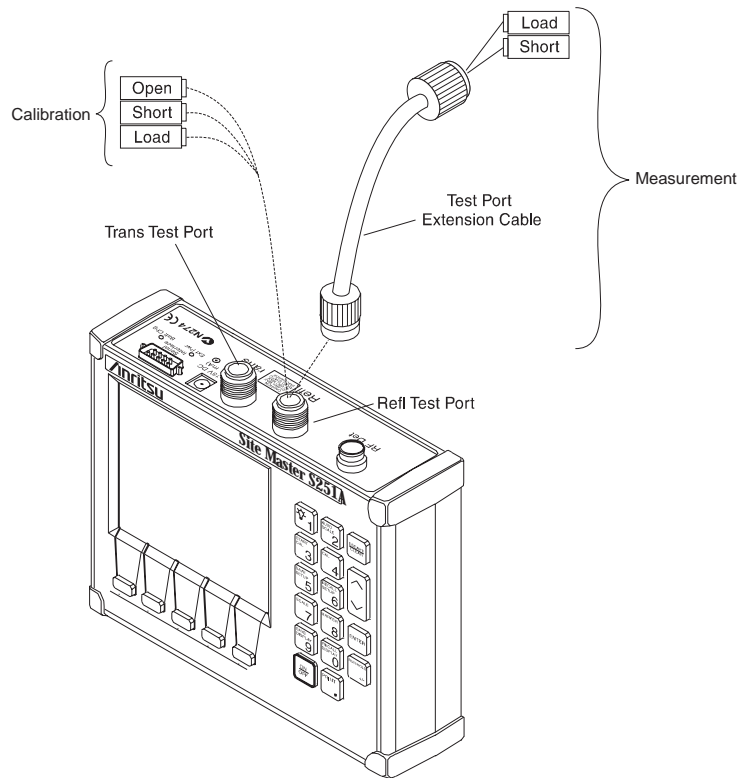

Figure 3-1. One-Port Calibration/Measurement Setup

## Selecting the Frequency Range

- Step 4.** Press the **FREQ** soft key.
- Step 5.** Press the **F1** soft key.
- Step 6.** Enter 8,0,0 using the keypad or **Up/Down Arrow** key. Press **ENTER** to set F1 to 800 MHz.
- Step 7.** Press the **F2** soft key.
- Step 8.** Enter 2,0,0,0 using the keypad or **Up/Down Arrow** key. Press **ENTER** to set F2 to 2000 MHz.

## Performing a Calibration

- Step 9.** Press the **START CAL** key. Follow the ensuing instructions that appear in the message area.
- Step 10.** Connect the Open to the REFL test port as shown in Figure 3-1. Press the **ENTER** key.
- Step 11.** When the measurement is complete, disconnect the Open and connect the Short to the REFL test port. Press the **ENTER** key.
- Step 12.** When the measurement is complete, disconnect the Short and connect the Load to the REFL test port. Press the **ENTER** key.

Figures 3-2 and 3-3 depict typical valid calibration measurements with Load attached.





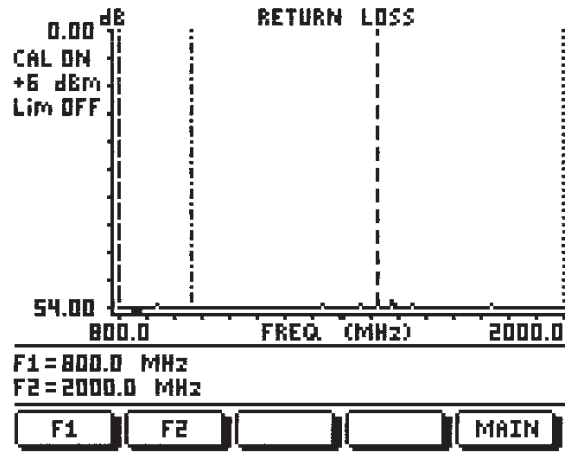

Figure 3-2. Return Loss Measurement Mode Calibration Results

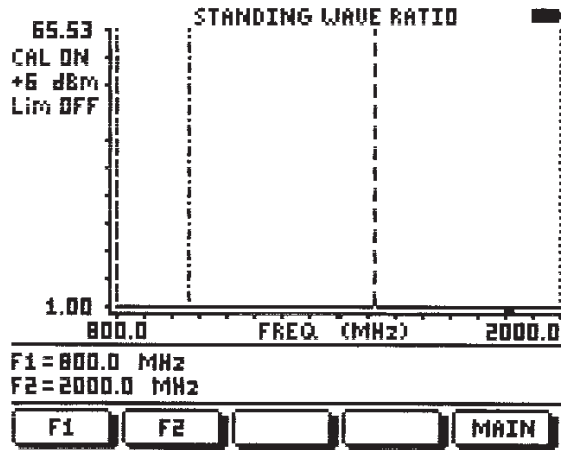

Figure 3-3. SWR Measurement Mode Calibration Results

## Cable Return Loss Measurement

- Step 13.** Disconnect the Load and connect the test port extension cable to the REFL test port. Connect the Load to the open end of the test port extension cable as shown in Figure 3-1.

## Setting the Limit Line

- Step 14.** Press the **SCALE** key to call up the Scale Menu (page 2-14).
- Step 15.** Press the **LIMIT** soft key and enter 2,7 using the keypad or **Up/Down Arrow** key. Press **ENTER** to set the limit line to 27.

## Setting the Markers

- Step 16.** Press the **MARKER** key to call up the Markers menu (page 2-23).
- Step 17.** Press the **M1** soft key to select the M1 marker function. Press **EDIT** soft key and enter 8, 2, 4 using the keypad or **Up/Down Arrow** key. Press **ENTER** to set M1 to 824 MHz. (Note: pressing the **ON/OFF** soft key activates or deactivates the M1 marker function.)
- Step 18.** Press the **BACK** soft key to return to the Markers menu.
- Step 19.** Repeat steps 17 and 18 for markers M2, M3, and M4. Set M2 to 960 MHz, M3 to 1710 MHz, and M4 to 1990 Mhz. (Figures 3-4 and 3-5 depict the cable return loss measurement.)



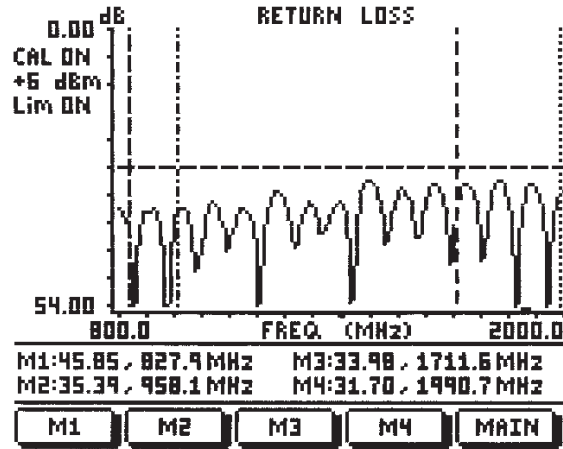

Figure 3-4. Cable Return Loss Measurement Results

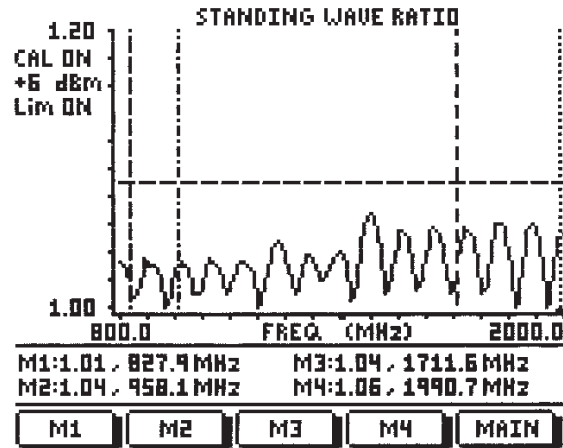

Figure 3-5. Cable SWR Measurement Results

## Saving Display to Memory

- Step 20.** Press the **SAVE DISPLAY** key to save the return loss measurement. Press **ENTER** to save to the current empty memory location or use the keypad or the **Up/Down Arrow** key to select another memory location. Press the **ENTER** key to implement. Use the keypad or the **Up/Down Arrow** key to manually enter the Time, Date, and Trace Designator for the save display.

## Cable Loss Measurement

- Step 21.** Disconnect the Load and connect the Short to the end of the test port extension cable (Figure 3-1). Observe the displayed measurement.
- Step 22.** Press the **BACK** soft key, the **MAIN** soft key, and the **MODE** soft key to activate the measurement mode. Use the **Up/Down Arrow** key to select CABLE LOSS-ONE PORT. Press the **ENTER** key to indicate selection.



## Scaling the Display

- Step 23.** Press the **SCALE** key and **BOTTOM** soft key. Enter 1 using the keypad or **Up/Down Arrow** key and press the **ENTER** key to change the marker value to 1 dB.
- or, press the **AUTO SCALE** key to automatically scale the display.

Figure 3-6 shows the cable loss measurement

### Saving Display to Memory

Step 24. Press the **SAVE DISPLAY** key to save the cable loss measurement to the next memory location (see step 20 for details).

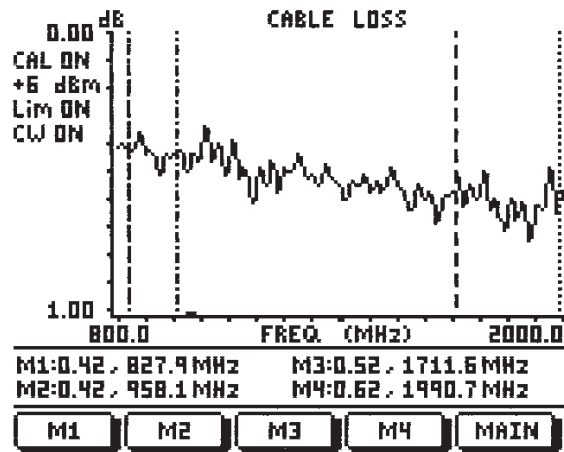

Figure 3-6. Cable Loss Measurement Results

## DTF Measurement

The following distance domain measurement is an example of a Distance-to-Fault (DTF) measurement over a selectable distance range.

### Required Equipment

- Site Master Model S251A
- Precision Open/Short, Anritsu 22N50
- Precision Load, Anritsu SM/PL
- Test Port Extension Cable, Anritsu 15NNF50-1.5A

### Device-Under-Test Specification

Type	Typical Loss @1.5m	V <sub>g</sub>
15NNF50-1.5A	0.40 dB @800 MHz 0.45 dB @900 MHz 0.60 dB @1710 MHz 0.70 dB @1990 MHz	0.86



### Procedure

**Step 1.** Press the **ON/OFF** key on the **Site Master**.

### DTF Parameters Setup

**Step 2.** Press the **MODE** soft key.

**Step 3.** Use the **Up/Down Arrow** key to scroll to DTF - Return Loss (or DTF - SWR). Press the **ENTER** key to select DTF in return loss (or SWR) measurement mode.

### Chapter 3 Operation

---

**Step 4.** In the DTF parameters table, scroll to D2 using the **Up/Down Arrow** key, then press **ENTER** to select cable length.

**NOTE:**

Where **CAL ON** is indicated on the **Site Master**, press the **DIST** soft key, then the **DTF AID** soft key to activate the DTF parameters table.

**Step 5.** Enter 2 using the keypad or **Up/Down Arrow** key. Press **ENTER** to set D2 to 2 meters.

**Step 6.** Use the **Up/Down Arrow** key to scroll to CF and press **ENTER** to select center frequency.

**Step 7.** Enter 1,4, 0, 0 using the keypad or **Up/Down Arrow** key. Press **ENTER** to set CF to 1400 MHz.

**NOTE:**

The reason  $CF = 1562.5$  MHz rather than 1400 MHz is that the maximum resolution distance, given the maximum frequency bandwidth of the **Site Master** (625 to 2500 Mhz), is 8.9 meters. Therefore, D2 of less than 8.9 meters will have a  $CF = 1562.5$  MHz.

**Step 8.** Use the **Up/Down Arrow** key to scroll to PROP VEL and press **ENTER** to customize cable propagation velocity.

- Step 9.** Enter ., 8, 6 using the keypad or **Up/Down Arrow** key. Press **ENTER** to set PROP VEL value to 0.86.
- Step 10.** Use the **Up/Down Arrow** key to scroll to LOSS and press **ENTER** to customize cable loss.
- Step 11.** Enter ., 3 using the keypad or **Up/Down Arrow** key. Press **ENTER** to set LOSS value to 0.3.

### **Performing a Calibration**

- Step 12.** Press **ENTER** to select EXIT - START CALIBRATION (or EXIT - START RE-CALIBRATION) to start calibration. Follow the ensuing instructions that appear in the message area.
- Step 13.** Connect the Open to the REFL test port as shown in Figure 3-1. Press the **ENTER** key.
- Step 14.** When the measurement is complete, disconnect the Open and connect the Short to the REFL test port. Press the **ENTER** key.
- Step 15.** When the measurement is complete, disconnect the Short and connect the Load to the REFL test port. Press the **ENTER** key.





## DTF Measurement (Determining the Length of the Cable)

**Step 16.** Disconnect the Load and connect the test port extension cable to the REFL test port. Connect the Short (or Open) to the open end of the test port extension cable as shown in Figure 3-1.

*Optional:* Press the **AUTO SCALE** key to optimize the amplitude scale.

**Step 17.** Press the **MARKER** key and the **M1** soft key to select the marker 1 function. (Note: pressing the **ON/OFF** soft key activates or deactivates the M1 marker function.)

**Step 18.** Press the **MORE** soft key, then the **PEAK** soft key to find the cable length. Press the **MKRS** soft key to return to the previous menu.

Figures 3-7 and 3-8 depict the DTF (cable length) measurement results.

**Step 19.** Press the **SAVE DISPLAY** key to save the DTF measurement. Press **ENTER** to save to the current empty memory location or use the keypad or the **Up/Down Arrow** key to select another memory location. Press the **ENTER** key to implement. Use the keypad or the **Up/Down Arrow** key to manually enter the Time, Date, and Trace Designator for the save display.

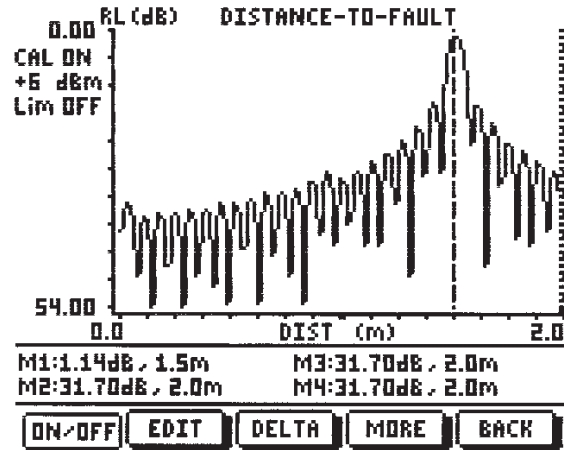

Figure 3-7. DTF-Return Loss Measurement Results (Cable Length)

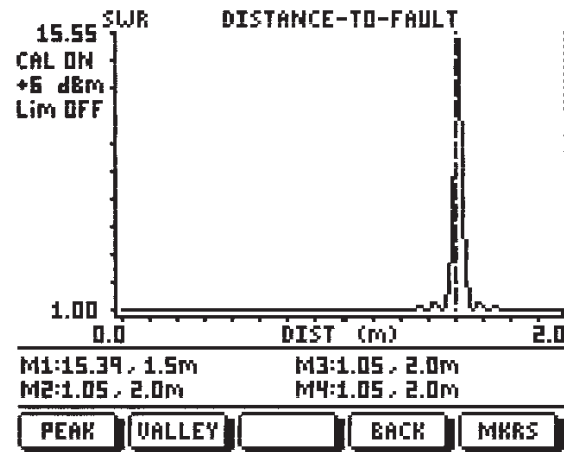

Figure 3-8. DTF-SWR Measurement Results (Cable Length)

## DTF Measurement (Determining the Quality of the Cable)

**Step 20.** Disconnect the Short (or Open) and connect the Load to the test port extension cable (Figure 3-1).

*Optional:* Press the **AUTO SCALE** key to optimize the amplitude scale.

**Step 21.** Press the **MARKER** key and the **M2** soft key to select the marker 2 function. (Note: pressing the **ON/OFF** soft key activates or deactivates the M2 marker function.)

**Step 22.** Press the **MORE** soft key, then the **PEAK** soft key to find the worst case average return loss with respect to distance. Press the **MKRS** soft key to return to the previous menu.

Figures 3-9 and 3-10 show the DTF (cable quality) measurement results.

**Step 23.** Press the **SAVE DISPLAY** key to save the DTF measurement to the next memory location (see step 19 for details).



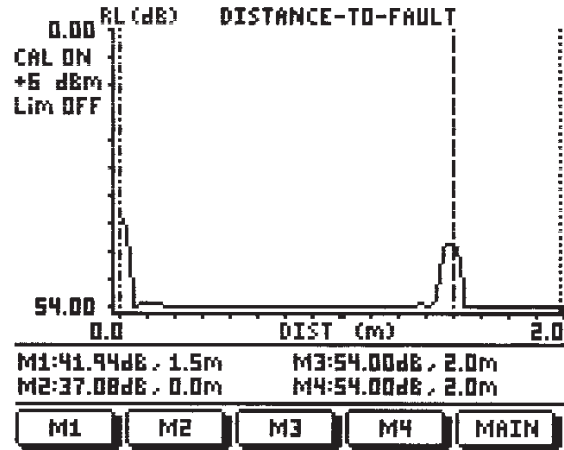

Figure 3-9. DTF-Return Loss Measurement Results (Cable Quality)

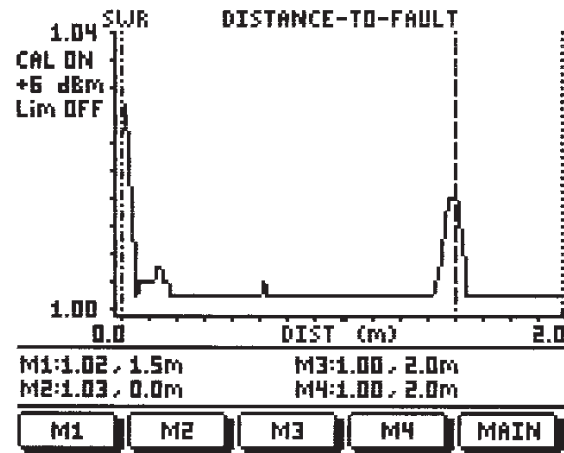

Figure 3-10. DTF-SWR Measurement Results (Cable Quality)

## Insertion Gain (Amplifier) Measurement

The following frequency domain measurement is an example of a Insertion Gain (Amplifier) measurement over a selectable frequency range.

### Required Equipment

- Site Master Model S251A
- (2) Precision 7/16(f) Open/Short/Load, Anritsu 2000-768
- (2) Test Port Extension Cable, Anritsu 15NDF50-1.5A
- 7/16(f) Adapter, Anritsu 510-97
- Tower Mount Amplifier, Ericsson A57001HQ85

### Device-Under-Test Specification



Type	Frequency Range	Gain (Typical)
TMA	1880 to 1910 MHz	12 dB

### Procedure

**Step 1.** Press the **ON/OFF** key on the Site Master.

### Insertion Gain Mode Selection

**Step 2.** Press the **MODE** soft key.

**Step 3.** Use the **Up/Down Arrow** key to scroll to **INSERTION GAIN (-30 dBm)**. Press the **ENTER** key to select insertion gain measurement mode.

## Selecting the Frequency Range

- Step 4.** Press the **FREQ** soft key.
- Step 5.** Press the **F1** soft key.
- Step 6.** Enter 1, 8, 4, 0 using the keypad or **Up/Down Arrow** key. Press **ENTER** to set F1 to 1840 MHz.
- Step 7.** Press the **F2** soft key.
- Step 8.** Enter 2, 0, 0, 0 using the keypad or **Up/Down Arrow** key. Press **ENTER** to set F2 to 2000 MHz.

## Performing a Calibration

- Step 9.** Connect the test port extension cables to the REFL and TRANS test ports as shown in Figure 3-11.
- Step 10.** Press the **START CAL** key. Follow the ensuing instructions that appear in the message area.
- Step 11.** Connect the Open to the open end of the REFL test port extension cable. Press the **ENTER** key.
- Step 12.** When the measurement is complete, disconnect the Open and connect the Short to the REFL test port extension. Press the **ENTER** key.
- Step 13.** When the measurement is complete, disconnect the Short and connect the Load to the REFL test port extension cable. Press the **ENTER** key.
- Step 14.** When the measurement is complete, connect the Load to the open end of the TRANS test port extension cable. Press the **ENTER** key.



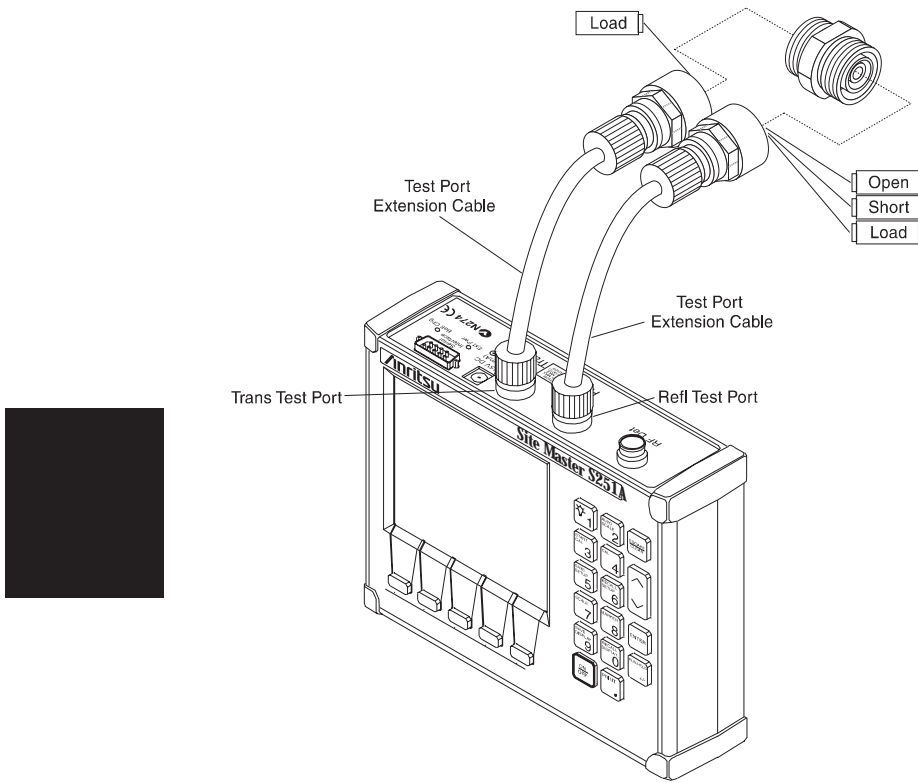

Figure 3-11. Two-Port Measurement Calibration Setup

**Step 15.** When the measurement is complete, disconnect both Loads from the test port extension cables and connect the 7/16(f) adapter to the open ends of the test port extension cables to complete a through path from the REFL to TRANS test port. Press the **ENTER** key.

When the measurement is complete the results should be similar to those shown in Figure 3-12.

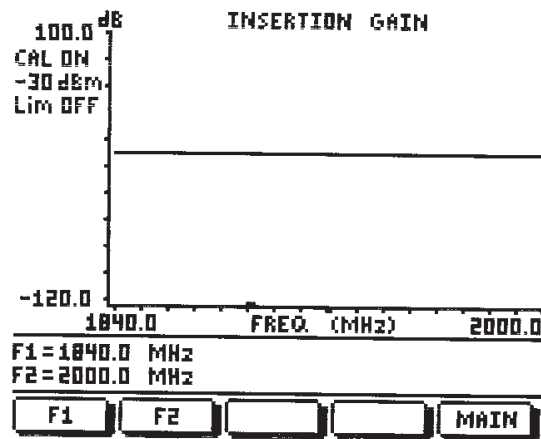

Figure 3-12. Two-Port Measurement Calibration Results



## Amplifier Gain Measurement

**Step 16.** Disconnect the 7/16(f) adapter. The resulting display should be similar to Figure 3-13.

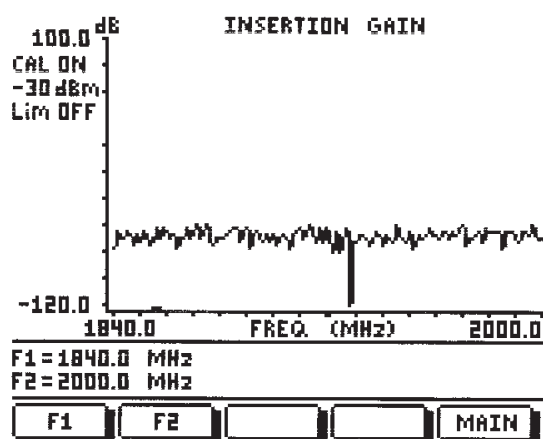

Figure 3-13. Measurement Display before Amplifier Connection

**Step 17.** Connect the amplifier to the test port extension cables as shown in Figure 3-14.

## Setting the Markers

**Step 18.** Press the **MARKER** key to call up the Markers menu (page 2-23).

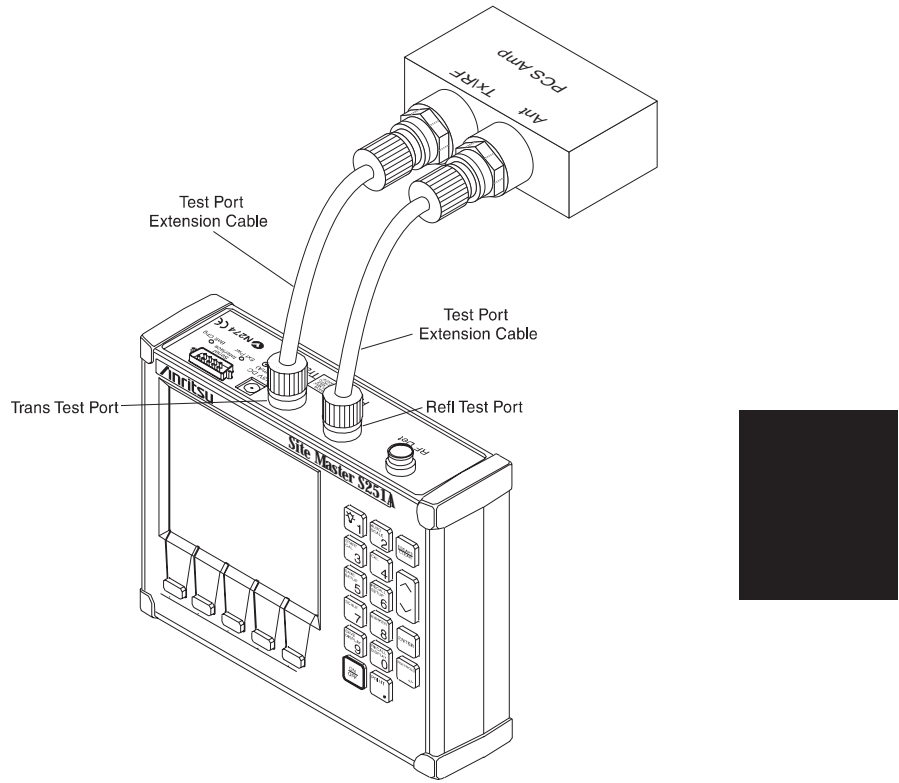

Figure 3-14. Amplifier Gain Measurement Setup

*Chapter 3 Operation*

---

- Step 19.** Press the **M1** soft key to select the M1 marker function. Press the **EDIT** soft key and enter 1, 8, 8, 0 using the keypad or **Up/Down Arrow** key. Press **ENTER** to set M1 to 1880 MHz. (Note: Pressing the **ON/OFF** soft key activates or deactivates the M1 marker function.)
- Step 20.** Press the **BACK** soft key to return to the Markers menu.
- Step 21.** Repeat steps 19 and 20 for markers M2, M3, and M4. Set M2 to 1910 MHz, M3 to 1960 MHz, and M4 to 1990 MHz.

Observe the bypass condition (Figure 3-15).

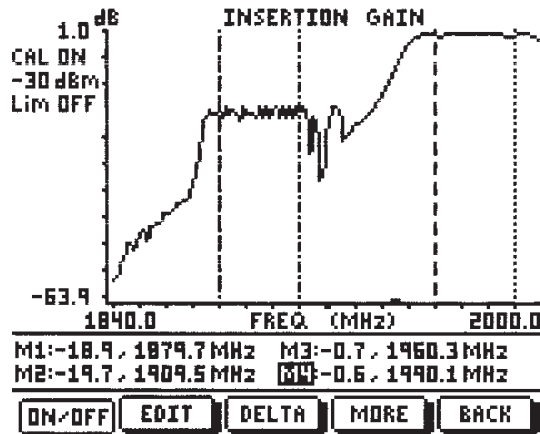

Figure 3-15. Measurement Display Showing Bypass Condition

### Activating the Bias Tee

- Step 22.** Press the **MAIN** soft key to return to the Main menu.
- Step 23.** Press the **OPT** soft key, then the **B3** soft key to activate the bias tee.

*NOTE:*  
*The Site Master must have Option 10 installed and the battery charger must be connected for the bias tee to activate.*

### Scaling the Display

- Step 24.** Press the **AUTO SCALE** key to narrow the display range.

Observe the display of amplifier gain performance (Figure 3-16 on the following page)



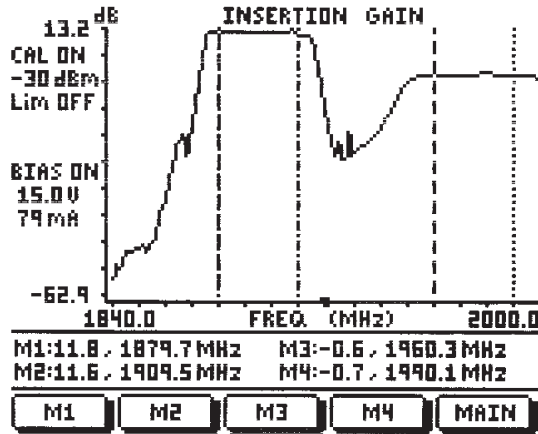

Figure 3-16. Measurement Display of Amplifier Gain

### Saving Display to Memory

- Step 25. Press the **SAVE DISPLAY** key to save the amplifier gain measurement. Press **ENTER** to save to the current empty memory location or use the keypad or the **Up/Down Arrow** key to select another memory location. Press the **ENTER** key to implement. Use the keypad or the **Up/Down Arrow** key to manually enter the Time, Date, and Trace Designator for the save display.

## Making Power Measurements

Power measurement is accomplished using a broadband (1 Mhz to 3 Ghz) RF detector, P/N 5400-71N50. The power monitor displays the measured power in dBm or Watts.

### Entering Power Monitor Mode

- Step 1.** Press the **MODE** soft key, from the Main menu (page 2-9).
- Step 2.** Use the **Up/Down Arrow** key to scroll to POWER MONITOR. Press **ENTER** to select power monitor mode.

### Zeroing the Power Monitor

- Step 3.** With no power applied to the DUT, press the **ZERO** soft key from the Power menu (page 2-11). Wait a few seconds while the **Site Master** accumulates samples of the quiescent power level. When complete, ZERO ADJ: ON is displayed in the message area.



### Measuring High Input Power Levels

- Step 4.** Insert an attenuator between the DUT and the RF detector, sufficient to insure that the input power to the Site Master is no greater than 20 dBm.
- Step 5.** Press the **OFFSET** soft key.
- Step 6.** Enter the attenuation in dB using the keypad. Press **ENTER** to complete the entry. The message area will show OFFSET is ON along with the entered value in dB.

### **Displaying Power in dBm and Watts**

**Step 7.** Press the **UNITS** soft key to display power in Watts.

### **Displaying Relative Power**

**Step 8.** With the desired base power level input to the Site Master, press the **REL** soft key. The message area will show REL: ON and the power reading will indicate 100%.

**Step 9.** Press the **UNITS** soft key to display power in dBm. Since REL is ON, the power reading will be in dBr, relative to the base power level.



## RF Source Operation

RF source allows the user to generate a single CW frequency with +6 dBm or -30 dBm output power within the instrument's operating frequency band.

### Generating a CW Frequency

- Step 1.** Press the **MODE** soft key, from the Main menu (page 2-9).
- Step 2.** Use the **Up/Down Arrow** key to scroll to RF SOURCE. Press **ENTER** to select RF source mode.
- Step 3.** Press the **FREQ** soft key, from the Main menu (page 2-12).
- Step 4.** Enter the desired numerical value using the keypad or the **Up/Down Arrow** key. Press **ENTER** when data entry is complete.
- Step 5.** Press the **POWER** soft key to toggle between +6 dBm and -30 dBm.
- Step 6.** Press the **MAIN** soft key to return to the Main menu.





# ***Chapter 4***

## ***Software Tools***

### ***Program***

#### **Description**

The **Site Master** Software Tools program provides the means for transferring the measured trace, along with any applied markers and/or a limit, to the screen of an MS-DOS based personal computer (PC) running Windows, Windows for Workgroups 3.xx, Windows NT, or Windows 95.

#### **Requirements**

The **Site Master** Software Tools program is a standard Windows 3.x program and will run on any computer that will run Windows, Windows for Workgroups 3.xx, Windows NT, or Windows 95. Typically, this means having a PC with the following characteristics:

- 386 or better microprocessor running enhanced mode (386DX, 33 MHz or better, recommended).
- 8 MBytes of memory, minimum.
- Hard Disk Drive, with approximately 3 MBytes of available space.



## Communication Port Setting

The **Site Master** Software Tools communicates with the **Site Master** through a standard COM port on the PC. It is important that your Windows COM port settings conform to the actual hardware settings. Table 3-1 provides a listing of standard COM port settings for most IBM AT-Compatible computers.

Table 3-1. Standard COM Port Settings

<u>Port</u>	<u>IRQ</u>	<u>Address</u>
COM1	4	3F8
COM2	3	2F8
COM3	4	3E8
COM4	3	2E8

Since various add-in devices such as sound cards, modems, and network cards use IRQ (Interrupts), it is possible that your computer has non-standard COM port settings. Please consult your computer vendor for COM port address and IRQ information.

### Changing COM Port Settings—Windows 3.1

Refer to Figure 3-1 while performing the following procedure.

- Step 1.** Open the **Windows Control Panel**.
- Step 2.** Double click on the **Ports** icon. The Ports dialog box appears.
- Step 3.** Click on the icon for the COM Port whose communications settings you wish to specify, then click the **Settings...** button. The Settings dialog box appears.

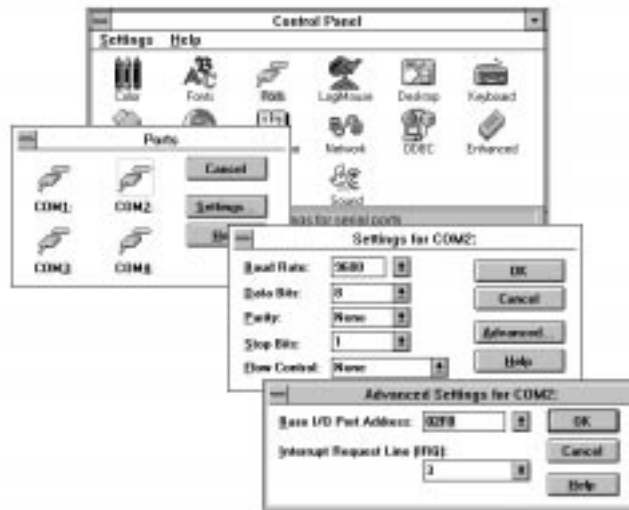

Figure 3-1. Windows 3.1 COM Port Setting Dialog Boxes

- Step 4.** Change to the following settings if necessary:
- Baud Rate: 9600
  - Data Bits: 8
  - Parity: None
  - Stop Bits: 1
  - Flow Control: None
- Step 5.** Click on the **Advanced...** button. At the Advanced Settings dialog box verify the COM Port Base Address and IRQ. Click **OK** when done.
- Step 6.** Click **OK** again and then **Close** to close the COM Port Setting Windows.



*Note:*  
*If you changed the COM Port Base Address and/or IRQ, you will need to restart Windows.*



Figure 3-2. Windows 95 COM Port Setting Dialog Boxes

## Changing COM Port Settings–Windows 95

Refer to Figure 3-2 while performing the following procedure.

- Step 1.** Open the **Windows Control Panel**.
- Step 2.** Double click on the **SYSTEM** icon. The System Properties window appears.
- Step 3.** Select **Device Manager**. The Device List appears.

---

*Chapter 4 Software Tools Program*

**Step 4.** Double click on the item **Ports (COM & LPT)** in the device list.

**Step 5.** Double click on the **Communications Port** you want to set. The Communications Port Properties window appears.

*NOTE:*  
*If Windows doesn't show any available COM Ports, consult your computer manufacturer.*

**Step 6.** Choose **Port Settings**, then change to the following settings if necessary.

Baud Rate: 9600  
Data Bits: 8  
Parity: None  
Stop Bits: 1  
Flow Control: None

**Step 7.** Choose **Resource** and verify the COM Port Base Address and IRQ. Click **OK** when done.

**Step 8.** Click **OK** again to close the System Properties window.

*Note:*  
*If you changed the COM Port Base Address and/or IRQ, you will need to restart Windows.*



## Software Installation

The **Site Master** Software Tools program is a conventional Microsoft Windows 3.x program. Installation is similar to all other such programs. For users new to Windows 3.x, a detailed procedure is given below.

- Step 1.** Insert the Anritsu **Site Master** Software Tools For Windows disk in floppy drive A:\ or B:\.
- Step 2.** In the Windows Program Manager, pull down the File menu and select Run. (For Windows 95 users, select Run under the Start menu.)
- Step 3.** Type A: (or B:)\SETUP, when the dialog box appears.
- Step 4.** Press the Enter key to select the default directory, C:\SITEMSTR, and begin the Setup routine.
- Step 5.** When the Setup program prompts, select “OK” or press the Enter key to restart Windows.



*NOTE: The Setup routine will create a new Program Manager Group named “Site Master Software Tools”. This group will contain three file icons, “Read Me,” “Site Master Help,” and “Site Master Software Tools.”*

- Step 6.** Double-click on the “Read Me” icon to read about (1) recent changes that did not get into this manual and/or (2) important features or problems that you should know about.

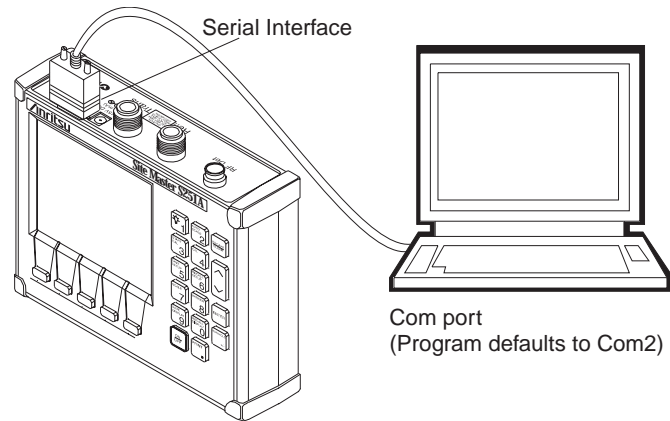

*Figure 3-3. Equipment Setup for Site Master Tools Operation*

- Step 7.** Double-click on the “Site Master Help” icon to acquaint yourself with the comprehensive on-line manual. This manual provides descriptive narrative for the various program features and controls.
- Step 8.** Double-click on the “Site Master Software Tools ” icon to open the Software Tools program.
- Step 9.** Click on Settings, in the top menu bar, and select COM Port. Enter the appropriate COM port number for the serial interface cable (null modem type).



## Plot Capture

Plots (traces) can be captured either singly from the **Site Master** display or in multiples from one or more stored-display locations. Both methods are described below.

The recommended method is the **Capture Multiple Traces** option in the **Capture** pull-down menu. Using this method, you can download to the Software Tools program in one operation all of the data residing in the up-to-70 Stored Display memory locations. The downloaded traces can be stored in a database or appear in cascade on the PC screen.

*NOTE: Trace scale can be captured as per **Site Master** or as autoscale by the capture program. To select per **Site Master** or autoscaling, click on **Settings** and **Default Plot Settings** from the top menu bar and pull-down menu.*

### Capture multiple to database

- Step 1.** Connect the supplied cable as shown in Figure 3-3.
- Step 2.** Open the “**Site Master Software Tools**” group, in the Windows Program Manager.  
*(Select the **Windows** pull-down menu from the Program Manager menu bar, and select **Site Master Software Tools**.)*
- Step 3.** Double-click on the “**Site Master Software Tools**” icon to open the program.





- Step 4.** Click on **Capture**, in the top menu bar, and select **Capture Multiple to Database** from the drop-down menu.
- Step 5.** Follow the database instructions to download the plot(s) to either a new database or an existing database.
- Step 6.** Enter the number(s) of the stored-display memory location(s) (1 to 50) from which you wish to store to the database, and click “OK”.
- Step 7.** Observe that the “Acquiring Control” box appears on the screen, then disappears as traces are automatically acquired. The “Database” box appears when the plot(s) has been completely captured into the database.

### **Capture multiple traces to PC screen**

- Step 1.** Perform steps 1, 2, and 3 of the capture-multiple-to-database procedure.
- Step 2.** Click on “**Capture Multiple Traces**” icon or click on **Capture**, in the top menu bar, and select **Capture Multiple Traces** from the drop-down menu.
- Step 3.** Enter the number (or numbers) of the stored-display memory location(s) (1 to 50) from which you wish to display traces in **Site Master Software Tools**.
- Step 4.** Select “OK.”
- Step 5.** Observe that the “Acquiring Control” box appears on the screen, then disappears as the traces are automatically acquired.



### Single trace capture

- Step 1.** Perform steps 1, 2, and 3 of the capture-multiple-to-database procedure.
- Step 2.** Click on “**Start a Plot Capture**” icon or click on **Capture**, in the top menu bar, and select **Start Capture** from the drop-down menu.
- Step 3.** Observe that a “Waiting for Data” box appears on the screen.
- Step 4.** On the **Site Master**,
- Capture a new trace and store it to a memory location.
  - Recall the stored plot to the screen.
  - Press the **ENTER** key (on the **Site Master**) to start the screen capture.

*NOTE: The **ENTER** key on the Site Master must be pressed while the PC screen shows “Waiting for Data” for the transfer of information to be complete.*

- Step 5.** On the PC, observe that the “Waiting for Data” box disappears and the trace capture process begins. Within a short time, the **Site Master** trace will appear.

## Program Operation

The captured trace on the PC can be scaled and have its limit line, markers, and properties changed. (Select **Plot Properties** under the **View** menu to make these changes.) The operation of the various menus that allow these operations to be accomplished is straightforward. To read about the operation of the menus, refer to the on-line help screens. They can be accessed from the **Help** menu, in the top menu bar.

## Fault Location Software

A captured RL or SWR trace can be transformed to a Distance to Fault display. This is useful for determining the location of faults, connections, and other discontinuities within the cable.

To transform a plot, select **Fault Find** from the **Tools** menu (or click the toolbar button). A drop down menu will appear that asks you to supply start and stop distances, along with propagation velocity and insertion loss values. The table in Appendix A provides these values for some of the more popular cables. The values are given at a nominal frequency of 1000 MHz. If values are needed at a different frequency, or if you need the exact values for more accurate measurement, please contact the cable manufacturer. Cables may be added to the list by editing the `cables.lst` file and following the existing format. The distance may be entered in feet or meters. Propagation velocity or dielectric constant may be used. The units may be changed by selecting **Default Plot Settings** under the **Settings** menu and changing “Distance Units” or “Cable Units.”

After supplying the needed information and clicking OK, a new plot will open showing cable match vs. distance.

## **Smith Chart Software**

After obtaining a frequency SWR or RL plot on the computer display, click the Smith Chart icon. Read the Help file to see how this feature functions (under Smith Chart and Data Readout).

## **Saving a Plot as a Windows Metafile**

Plots can be saved as Windows Metafiles (.WMF). The metafile may be imported into other graphic programs, but cannot be reloaded into the Site Master Software Tools program.

To save a plot as a Windows Metafile, click on **File**, in the top menu bar, and select **Save as Metafile** from the drop down menu.



## **Saving Data to a Spreadsheet**

The data points from a plot can be exported to a spreadsheet via the clipboard. To transfer data to a Windows spreadsheet program:

- Step 1.** Select **Settings** and **Clipboard Format** from the top menu bar and pull-down menu and choose **Formatted Text**.
- Step 2.** Capture or load the desired plot.
- Step 3.** Copy the data to the clipboard by selecting the “**Copy to Clipboard**” icon or **Copy** from the Edit menu.
- Step 4.** Open the spreadsheet program and place the cursor where the first data point should appear.
- Step 5.** Select **Paste** from the spreadsheet program's Edit menu.

## **Saving Data to a Database**

Plots can be saved to a database. Comments can be added to the plot data saved. Queries of the database provide a means of comparing plots in the database. Refer to the on-line help screens for operating instructions.

To save a plot to a database, click on **File**, in the top menu bar, and select **Save Plot to Database** from the drop-down menu.



## “Drag-n-Drop”

**Site Master** Software Tools is Windows based. Graphs can “Drag-n-Drop” onto each other. **Site Master** Software Tools allows quick comparison of “before” and “after” Distance-To-Fault measurements. Recent data is compared to a historical PC database record, which is usually recorded during site installation/commissioning.

Each cable/antenna tends to have a unique Distance-To-Fault (DTF) “Signature” because differing cable electrical lengths, cable types, dielectric thickness variations, and the positions of components (connectors, adapters, and lightning arrestors) will cause different reflections at differing positions in the transmission line. Variations in the “signature” between maintenance intervals offer a good indication of damage or damage causing conditions.

## Printing

Captured traces may be printed from a PC using **Site Master** Software Tools. Once a captured trace has been downloaded choose **Print** under the **File** menu for printing options. The printer setup can be altered, plots can be scaled, and multiple plots can be printed from the Print dialog box.



# Appendix A

## Reference Data

### Description

Table A-1 provides a standard listing of common coaxial cables along with their “Relative Propagation Velocity” and “Nominal Attenuation in dB/m @1000 MHz” values. Figure A-1 (page A-4) is a plot of maximum range and resolution vs frequency span.

Table A-1. Coaxial Cable Technical Data (1 of 3)

Cable Type	Relative Propagation Velocity ( $V_f$ )	Nominal Attenuation dB/m @ 1000 MHz
RG8, 8A, 10, 10A	0.659	0.262
RG9, 9A	0.659	0.289
RG17, 17A	0.659	0.180
RG55, 55A, 55B	0.659	0.541
RG58, 58B	0.659	0.558
RG58A, 58C	0.659	0.787
RG142	0.690	0.443
RG174	0.660	0.984
RG178B	0.690	1.509
RG187, 188	0.690	1.017
RG213/U	0.660	0.292
RG214	0.659	0.292
RG223	0.659	0.535

**Appendix A Reference Data**

---

*Table A-1. Coaxial Cable Technical Data (2 of 3)*

<b>Cable Type</b>	<b>Relative Propagation Velocity (<math>V_f</math>)</b>	<b>Nominal Attenuation dB/m @ 1000 MHz</b>
FSJ1-50A	0.840	0.197
FSJ2-50	0.830	0.134
FSJ4-50B	0.810	0.119
LDF4-50A	0.880	0.077
LDF5-50A	0.890	0.043
LDF6-50	0.890	0.032
LDF7-50A	0.880	0.027
LDF12-50	0.880	0.022
HJ4-50	0.914	0.087
HJ4.5-50	0.920	0.054
HJ5-50	0.916	0.042
HJ7-50A	0.921	0.023
LMR100	0.800	0.792
LMR200	0.830	0.344
LMR240	0.840	0.262
LMR400	0.850	0.135
LMR500	0.860	0.109
LMR600	0.870	0.087
LMR900	0.870	0.056
LMR1200	0.880	0.044
LMR1700	0.890	0.033
HCC12-50J	0.915	0.042
HCC78-50J	0.915	0.042
HCC158-50J	0.950	0.023



*Appendix A Reference Data*

*Table A-1. Coaxial Cable Technical Data (3 of 3)*

<b>Cable Type</b>	<b>Relative Propagation Velocity (<math>V_f</math>)</b>	<b>Nominal Attenuation dB/m @ 1000 MHz</b>
HCC300-50J	0.960	0.014
HCC312-50J	0.960	0.013
HF 4-1/8" Cu2Y	0.970	0.010
HF 5" Cu2Y	0.960	0.007
HF 6-1/8" Cu2Y	0.970	0.006
FLC 38-50J	0.880	0.115
FLC 12-50J	0.880	0.075
FLC 78-50J	0.880	0.045
FLC 114-50J	0.880	0.034
FLC 158-50J	0.880	0.029
CR50 540PE	0.880	0.070
CR50 1070PE	0.880	0.038
310801	0.820	0.115
311201	0.800	0.180
311501	0.800	0.230
311601	0.800	0.262
311901	0.800	0.377
352001	0.800	0.377

*Appendix A Reference Data*

---

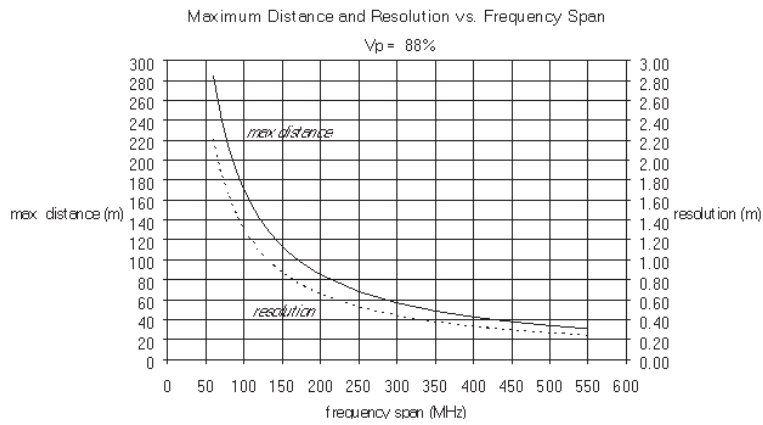
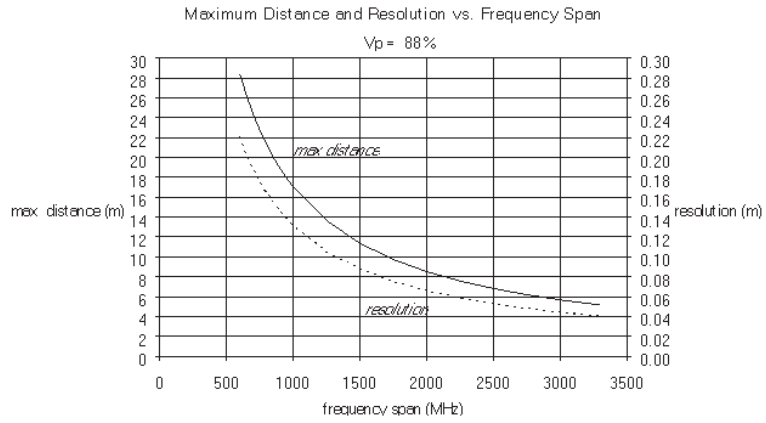

---

Figure A-1. *Maximum Distance and Resolution vs Frequency Span*



**Anritsu**

Color Cover P/N: 00986-00022