



Advanced Test Equipment Corp.

www.atecorp.com

800-404-ATEC (2832)

# iTIG III STATIC MOTOR TESTER AND WINDING ANALYZER



**FIND MORE FAULTS WITH ONE INSTRUMENT**



EXCELLENCE IN MOTOR AND COIL TESTERS

# THE iTIG III

The iTIG III is the industry's most advanced electric motor tester and winding analyzer. Bringing confidence to motor repair companies, industrial end users, OEMs, and manufacturers of rotating equipment, the iTIG III features over 20 high- and low-voltage tests including high frequency surge and partial discharge.

Choose multiple tests to run automatically in a sequence or select single tests. Report results with the easiest to use instrument available. Manually operate voltage dial or set up for automatic operation. Carry the iTIG III in the field or use it as a benchtop device. Connect to an external portable power pack for testing up to 40kV. The iTIG III is the most versatile and easy-to-use tester available.



**iTIG III**

Max Output Voltages: 4kV, 6kV, 12kV, and 15kV



**iTIG III with Power Pack III**

Max Output Voltages: 18kV, 24kV, 30kV, and 40kV

## Features

- High Frequency Surge Test - Finds More Faults
- Partial Discharge Test - No Accessories Required
- Highly Accurate Leakage Current Measurement
  - No need for separate specialized hipot/megohm instrument
- Time Saving Reporting Tools
  - Powerful Trend Analysis
- Lightweight and Rugged Case
- Easy-to-use Touch Screen Interface
- Fully Automatic Test Sequences

## Tests

- Surge Comparison including
  - Phase-to-Phase
  - Pulse-to-Pulse
  - Coil-to-Coil
- Partial Discharge (PD) including
  - RPDIV (inception voltage)
  - RPDEV (extinction voltage)
- DC Hipot including
  - Programmable Step Voltage
  - Ramp
- Insulation Resistance:
  - Megohm
  - Polarization Index (PI)
  - Dielectric Absorption (DAR)
- Winding Resistance, 4-wire ( $\mu\Omega$ )
- Capacitance (C)
- Inductance (L)
- Impedance (Z)
- Phase Angle
- Rotor Influence Check (RIC)

# WHO TRUSTS ELECTROM?

## Motor Shops

The iTIG III delivers best-in-class accuracy in measurements and diagnostics. Be confident with your decision to maintain, repair, or recondition a motor. Choose multiple tests to run automatically in a sequence or select single tests. Preset test parameters and pass/fail criteria. Conduct multi-coil testing quickly and efficiently. Generate complete electronic reports on the tester and transfer them to a server with one click of a button, or generate the reports on a PC.



## Motor and Coil Manufacturers

On the production floor or in the R&D lab, motor and coil manufacturers rely on the iTIG III for quality assurance and new technology development. Automate your production line testing with bar code scanning, external controls, and automatic uploading of test data. Develop and manufacture state-of-the-art motors, generators, alternators, or coils — large or small — and rest assured you are shipping the most reliable product for your customer's money.

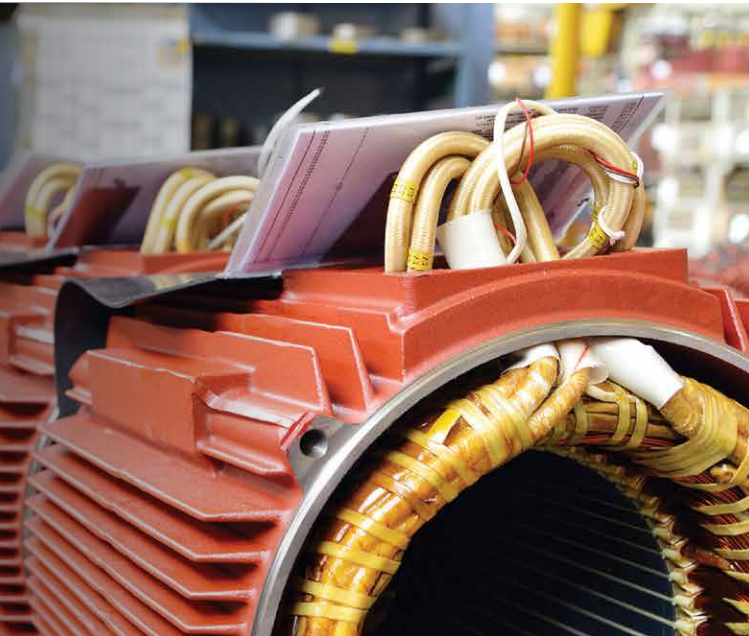

## Industrial Services & End Users

In the field or on site, the iTIG III is the most portable high voltage tester. With automated test sequences up to 15kV, the iTIG III has you covered for field testing needs and service calls. For high-voltage motors, add the Power Pack III, the only truly portable external power pack on the market with output up to 40kV. Avoid costly downtime and unplanned outages with industry leading sensitivity that finds more faults.

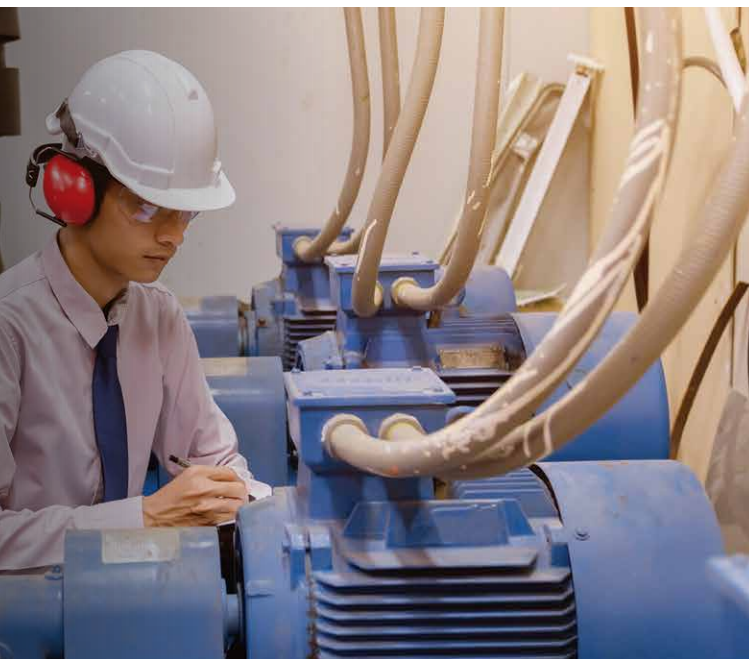

## Low, Medium, and High Voltage Tests That Find More Faults

The iTIG III uses low voltage measurements such as capacitance, inductance, impedance, and phase angle to find “hard” failures and critical changes in the windings.

Medium voltage measurements such as Megohm, Dielectric Absorption (DAR), and Polarization Index (PI) are used to test the ground-wall insulation resistance. The megohm (IR) test is known as the dirt test and mainly indicates how contaminated the windings are. The DAR and especially the PI test provides additional information about the insulation condition when the insulation is weak.

High voltage tests are required to find an insulation weakness above operating voltages. High Voltage testing stresses the insulation but is not destructive due to the low energy available for an arc. DC Hipot, Step Voltage and Ramp tests will find the voltage at which the ground insulation starts to break down.

The high voltage surge test is the only test that finds turn-to-turn weaknesses. It can also find shorts and weaknesses phase-to-phase, coil-to-coil and in many cases finds wrong connections. Catastrophic insulation faults, such as ground-wall failures, often start as a turn-to-turn weakness that progresses to a blowout.

Partial Discharge (PD) tests can find insulation weaknesses earlier than any other test for both high and low voltage motors. It is used for QA, maintenance and diagnostic purposes. PD is an important test for motors used in VFD power applications since VFDs can generate PD leading to failures if the power system is misapplied.

### LOW VOLTAGE

Winding Resistance  
Capacitance (C)  
Inductance(L)  
Impedance (Z)

### MEDIUM VOLTAGE

Insulation Resistance  
Megohm  
DAR  
PI

### HIGH VOLTAGE

DC Hipot  
Step Voltage/Ramp  
Surge Comparison  
Partial Discharge

## Know Your Motor - Test concentric or lap wound stators

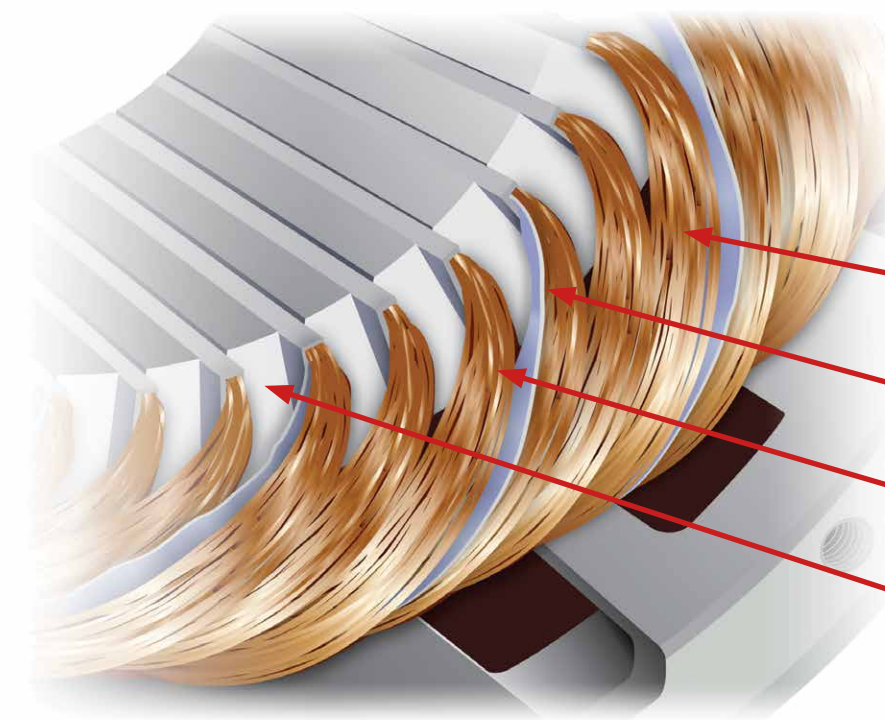

A surge test finds these common motor failure modes:

Turn-to-Turn

Phase-to-Phase

Coil-to-Coil

Phase-to-Ground

# ADVANCED TEST TECHNOLOGIES

Find more faults and insulation weaknesses with the iTIG III's highly sensitive and accurate range of tests. It's easy to use. Simply enter information using default settings, copy settings from other motors, or import motor nameplate information and automatically conduct a full range of tests. No PD accessories or manual lead switching are required on the Model D. No need to manually adjust voltage range and sweep. No need to set PD noise/signal threshold limits.

## High Frequency Surge Test Finds More Faults

The iTIG III generates fully automatic software controlled surge voltage pulses at a repetition rate up to 50Hz in compliance with IEEE 522. This high frequency surge test eliminates ionization dissipation typically seen with low frequency testers. As a result, the iTIG III finds more cases of weak insulation than low frequency surge testers.

Conduct pulse-to-pulse surge tests which can eliminate the need to turn rotors by hand during testing of an assembled motor. The surge test can also be used on motors with normal differences in phases such as those with concentric windings, and on single phase motors and coils when there are no other phases to compare to.

## Partial Discharge Testing Has Never Been Easier

The iTIG III is free of internal PD so no adjustments to the signal/noise threshold limit is necessary as the

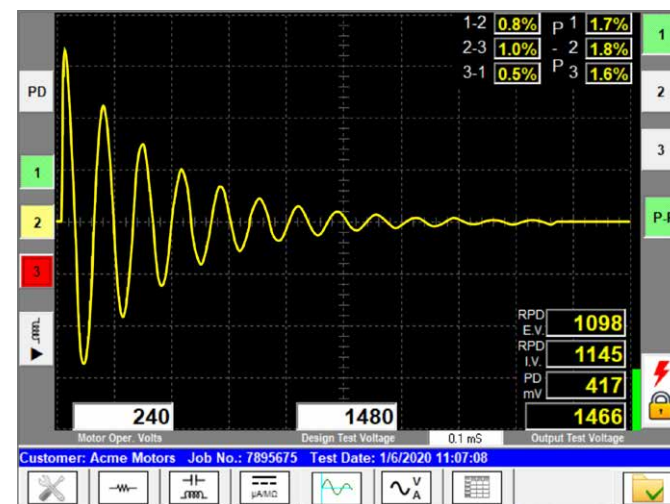

Surge Test

## Auto Mode Setup

Selected tests run automatically.

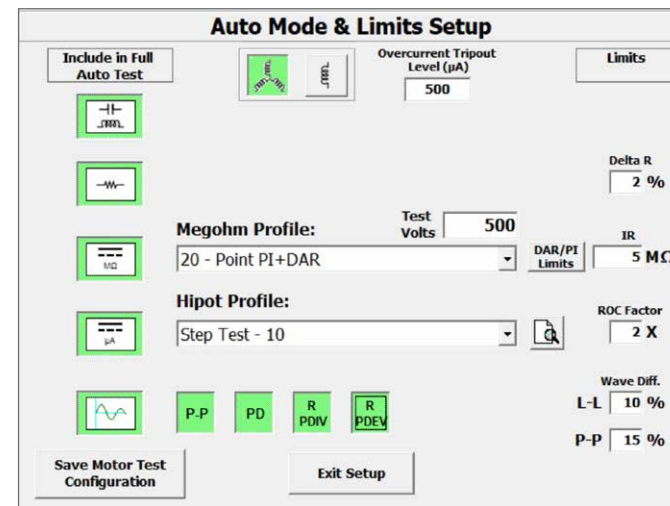

Green icons are included in the automated test sequence.

test voltage increases. Electrom offers two levels of PD hardware and output leads for tests to 6kV and 15kV.

Without the need to add accessories, partial discharge testing is easy. The partial discharge measurements are highly sensitive and can detect insulation breakdown in an electric motor before surge tests, hipot test and online monitoring.

The partial discharge screen displays repetitive PD inception voltage (RPDIV), extinction voltage (RPDEV), and maximum partial discharge levels in mV in compliance with IEC 61934.

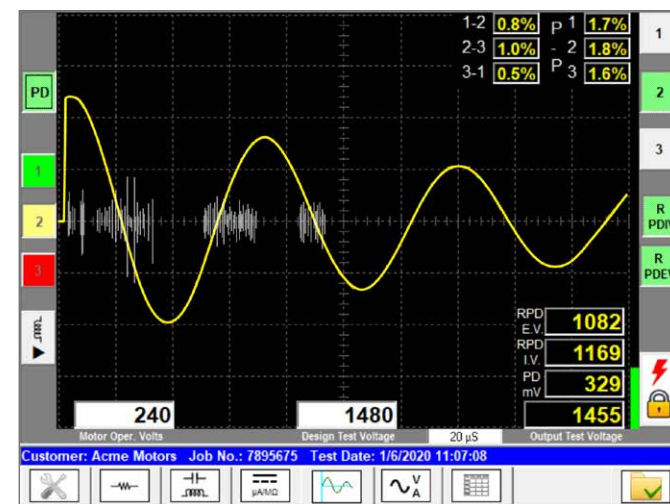

Partial Discharge Test

## Screen Button Icons

Tests available vary with model and options.

Only available test and information tabs will show.

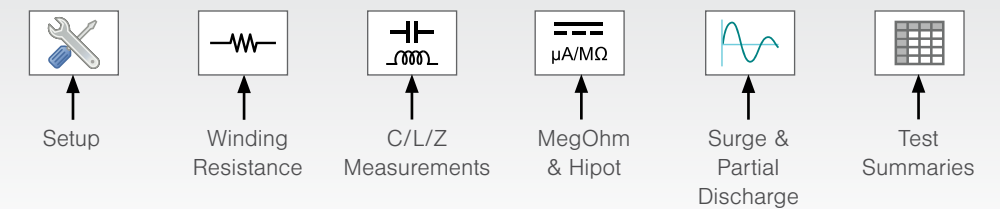

## Leave The Single Purpose Megohm Tester At Home

The iTIG III measures leakage current with 10 pA resolution and a highly accurate measurement down to 500 pA. The resulting IR range at 15kV is up to 30 TΩ. This means PI tests can be done accurately on motors with very low leakage current. PI results from multiple tests can be graphed, similar to the picture below.

Together the DC Hipot and MegOhm (IR) tests provide information on several ground-wall weaknesses and faults. For medium and high voltage equipment the Hipot Step Voltage or Ramp test should always be used.

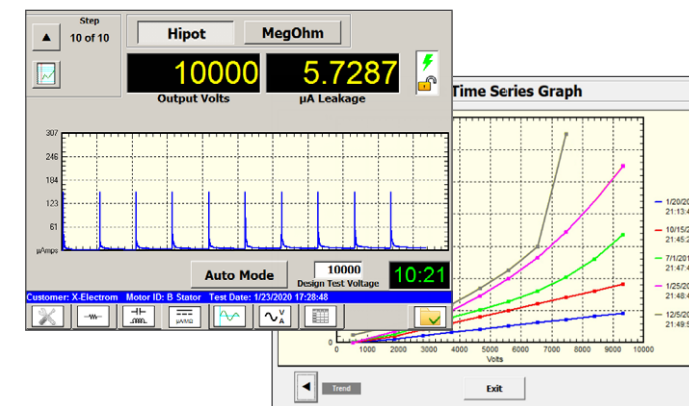

## Step Voltage Current Progress and 5 Hipot Step Voltage Test Results

## Accurate Winding Resistance with 1 µΩ Resolution

This test is used to find several faults such as open windings, shorts to ground, resistive connections, connection errors, resistance imbalance between phases, and more. The iTIG III features 4-wire Kelvin clamp systems for highly accurate measurements. They can be done directly through the high voltage leads. Test results are temperature corrected and reported in milli- or micro-ohms. The micro-ohm measurement can be used to measure resistance bar-to-bar on armatures and to find broken equalizers. See Accessories.

## CLZ Measurements

The iTIG III measures capacitance (C), inductance (L), and impedance (Z) which are used to check for imbalances, track results over time, and in conjunction with other tests diagnose problems. CLZ measurements can be part of automatic sequences of tests through the high voltage leads. Squirrel cage rotors in assembled motors can be tested with the CLZ option for broken rotor bars using the RIC test.

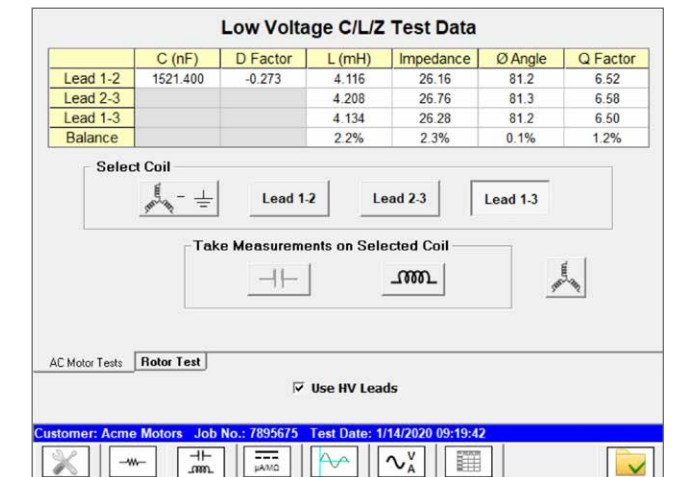

## CLZ Measurements

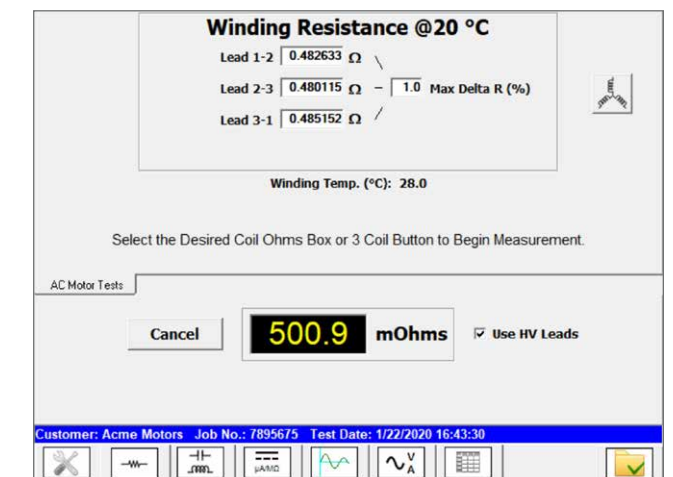

## Winding Resistance Test

# TEST REPORTING

## TRPro Report & Analysis Software

Save time with the iTIG III-Models B, C, and D by generating complete reports with the click of a button. Millions of tests can be saved and charts, tables, and trend capturing multi-test Hipot and PI graphs generated.

TRPro report and analysis software for PCs imports test data and like the iTIG III can also generate advanced reports

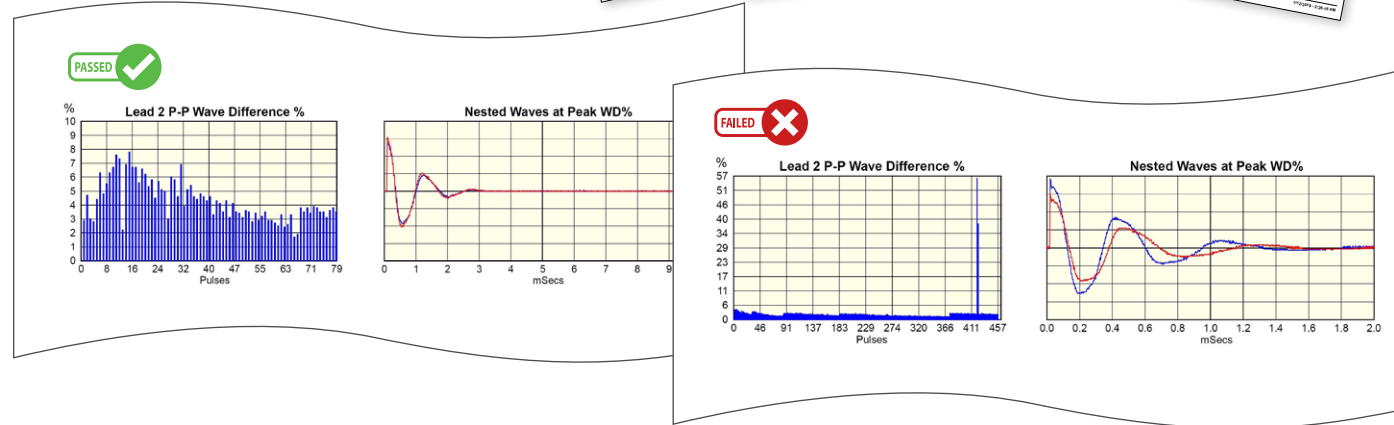
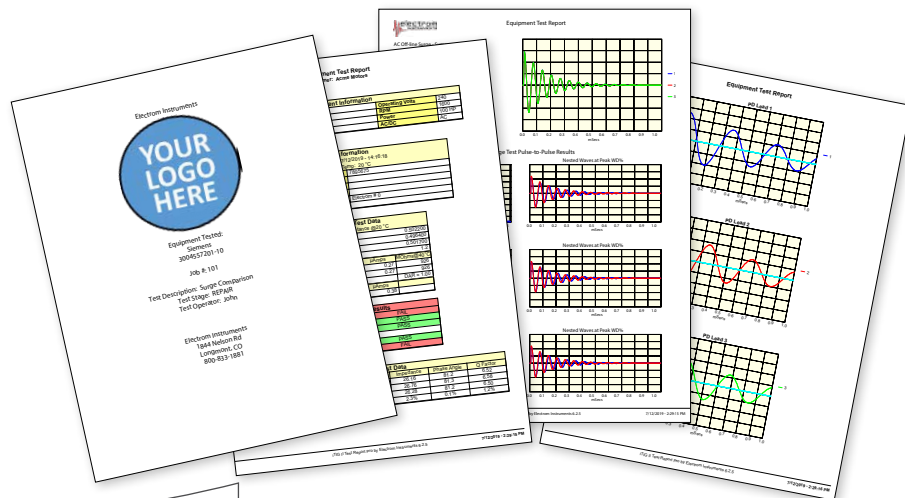

## Motor Data Import for Large Groups of Motors

Information about motors or coils to be tested is entered manually or by using import software. For individual motors, data is entered one-by-one using the screen keyboard or a USB keyboard.

In some applications such as industrial manufacturing or processing plants, data on large groups of individual motors are known. In this case, motor information files for the iTIG III are generated from the user's Excel or CSV motor database file and imported into the iTIG III. This eliminates entry mistakes and duplication of entries. It allows the test operator to search for a serial number or asset tag and start testing without entering motor information.

Motor data import of large motor databases is optional at the time of purchase and can also be added at a later date.

## Data Transfer

Motor data, test data, and reports can be transferred from the iTIG III with one click using a USB Flash Drive, Ethernet, or Wi-Fi. Transfer reports to a PC or server for access by multiple users. Reports can be automatically transferred by job number to database systems like MotorBase® and ACS/Traverse®.



# TREND ANALYSIS

## Test Summaries File

Make trend analysis easy with the Test Summaries file. This file is generated by the iTIG III-Model D. At the conclusion of each test set, the file is appended with date/time-stamped data containing test results and other info. The Test Summary file is a comma separated values (.csv) file and can be viewed, sorted and filtered in Excel or other spreadsheet formats. Users can graph multiple tests of the same motor over time to spot trends clearly.

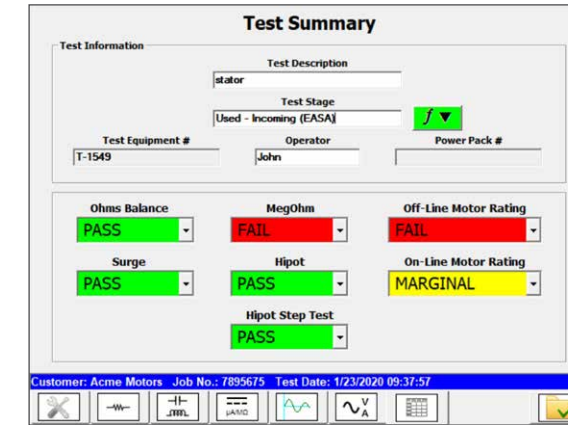

The Test Summary screen (left) is viewable on the iTIG III and in TRPro. It displays pass/fail test results. Click tabs along the bottom row to view each test. Repeat any individual test before the test set is finalized.

The TRPro report software has powerful filtering tools that help to identify weak motors, motors that are in the wrong application, brands that do not perform well in certain applications, etc. For example, compare test results for motors with the same or similar specifications, such as: Brand X, 4160V, 1000HP, 1775RPM, Frame#XYZ123.

Using TRPro report software, filters can be set on any information in the user's motor database and automatically applied to the Test Summary File to determine which motors to include in a group. Furthermore, information in the user's motor database that is not in the Test Summary File can be selected and automatically added to the filtered Test Summary by TRPro.

MOTOR	ID	DATE	TIME	DESCR.	TEMP.	MEGOHM	HIPOUT	SURGE	OHMS	R 1-2	R 2-3	R 3-1	R%	MAX DELTA	WD%	SURGE	WD%	SURGE
1	M23154	7/12/2019	2:07:12 PM	Maintenar	20	PASS	PASS	PASS	PASS	0.5003	0.5006	0.4957	1.3					
2	M54578	7/12/2019	2:26:18 PM	Diagnosis	23	PASS	PASS	FAIL	PASS	0.5005	0.5039	0.5011	0.7					
3	M31459	7/12/2019	3:16:18 PM	Diagnosis	25	PASS	PASS	FAIL	PASS	0.5022	0.4964	0.5017	1.2					
4	M31459	8/20/2019	11:55:48 AM	Maintenar	21	PASS	PASS	PASS	PASS	0.4983	0.4957	0.5009	1					
5	M23179	8/20/2019	11:55:48 AM	Maintenar	20	PASS	PASS	PASS	PASS	0.4962	0.5025	0.5013	1.3					
6	M24659	8/20/2019	12:09:25 PM	Maintenar	19	PASS	PASS	PASS	PASS	0.5009	0	0.5011	1					
7	M54570	8/21/2019	11:07:08 AM	Maintenar	18	PASS	PASS	PASS	PASS	0.4983	0	0.5009	1					
8	M23107	8/21/2019	11:07:08 AM	Maintenar	22	PASS	PASS	PASS	PASS	0.4981	0	0.5024	0.9					

The Test Summary file contains over fifty columns of data. Additional information from the user's motor database can be added automatically by TRPro.

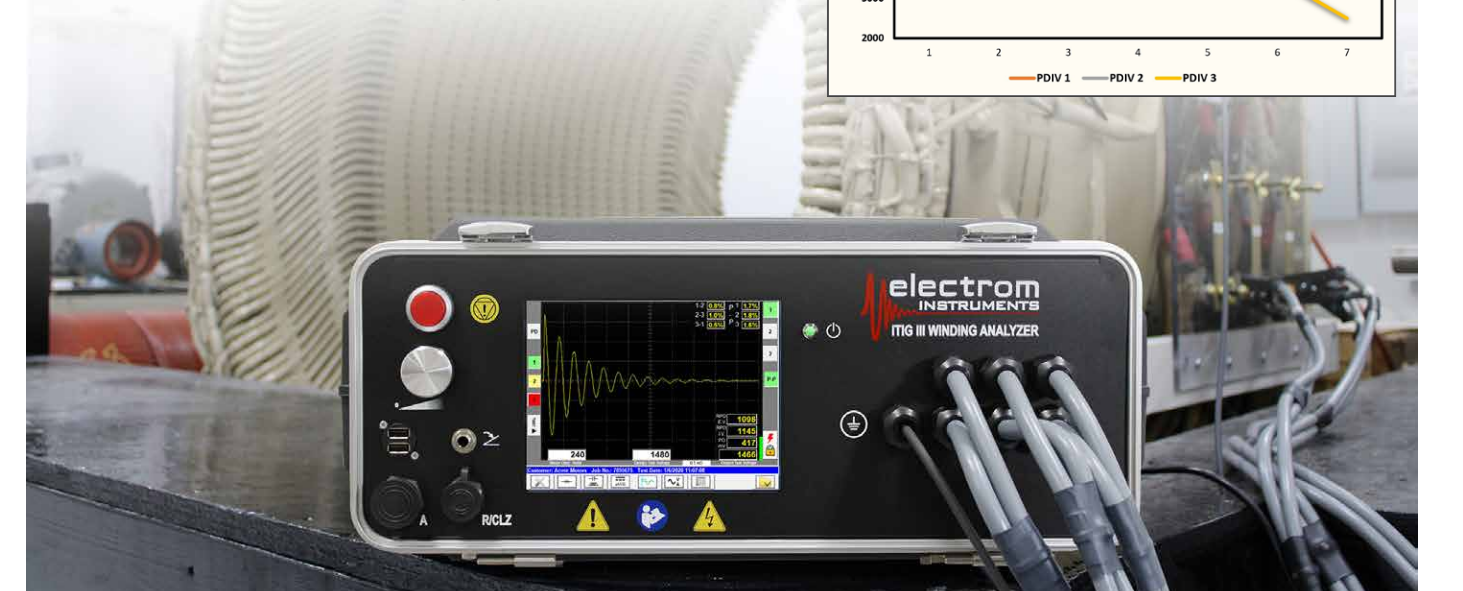
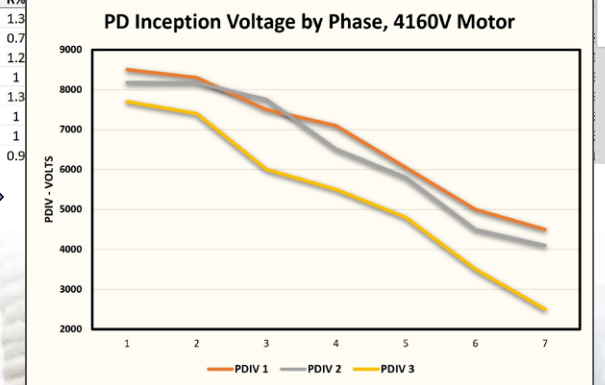

# iTIG III OVERVIEW

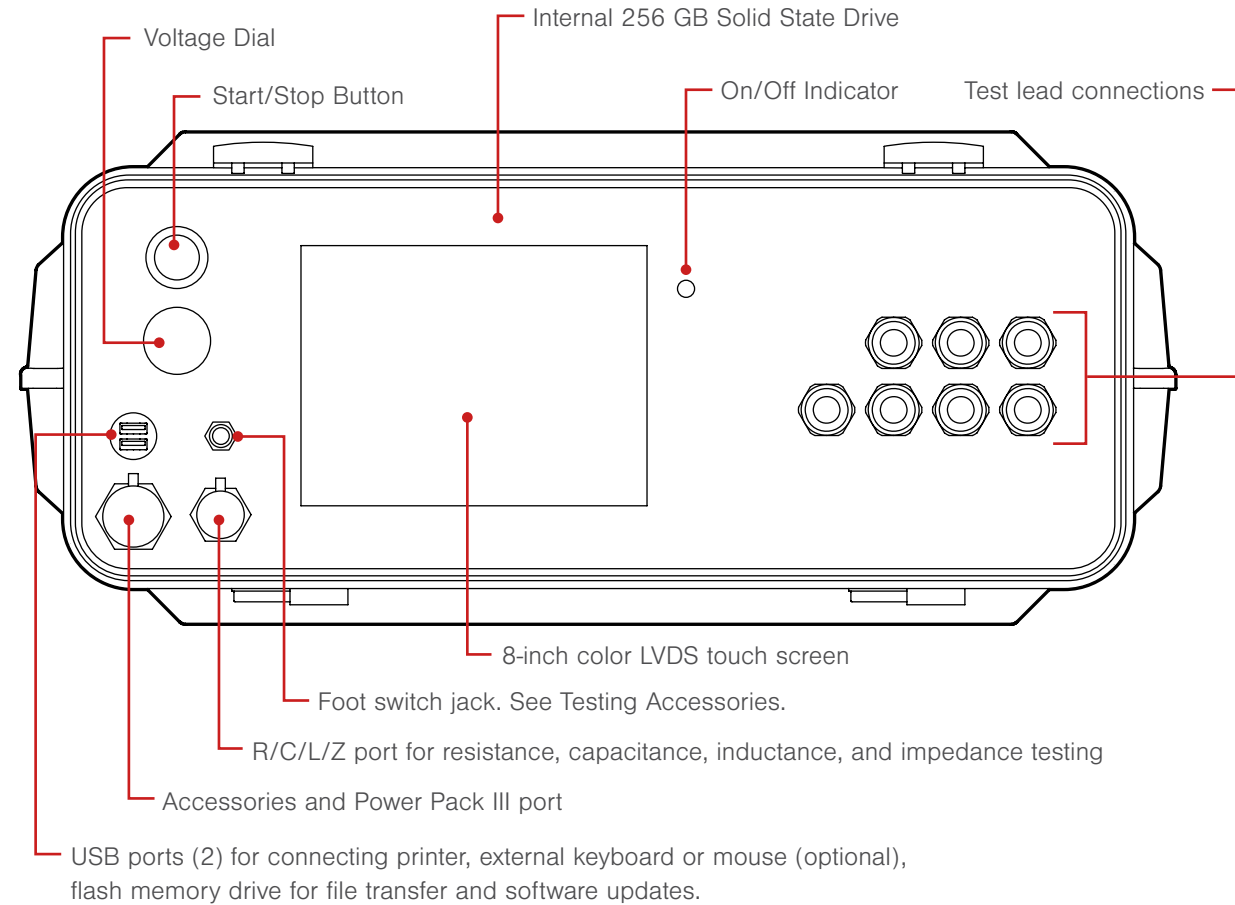

## iTIG III

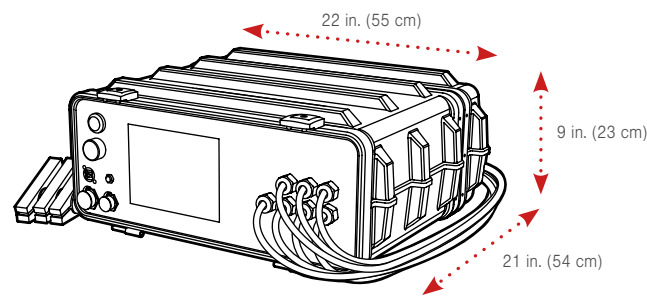

## iTIG III AND POWER PACK III

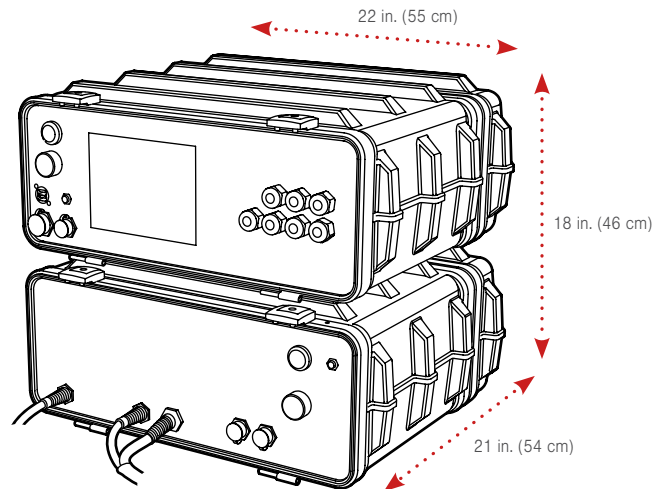

### Weight by Model

4kV	6kV	12kV	12kV-H	15kV-H
33-37 lbs. (15-17 kg)	33-37 lbs. (15-17 kg)	35-39 lbs. (16-18 kg)	38-42 lbs. (17-19 kg)	42-46 lbs. (19-21 kg)



The iTIG III is WiFi and Ethernet compatible for printing and report transfer.

# DC MOTOR ACCESSORIES

Use the iTIG III to test DC motors using DC testing accessories. Dedicated user interface for DC testing is easy to use for multi-coil testing.



### ATF-11: Armature Test Fixture

The ATF-11 is used to conduct span surge tests of DC motor armatures. With an adjustable design, a span test covers multiple-bars. Use with a FS-12 foot switch for easy operation.



### ABT: Armature Bar-to-Bar Surge Test Accessory

Use this accessory to conduct a bar-to-bar surge comparison test or to surge test single coils with very low inductance. The test voltage measurement is 4-wire and not load dependent. Compatible with iTIG III models B, C, or D. Max ABT output is 1400V. It comes with the BBP bar-to-bar probe and FS-12 foot switch.



### ASP: Surge Probe Set

The ASP is an alternate to the BBP bar-to-bar probe and connects to the ABT. It can be used for both bar-to-bar tests and span tests. The voltage measurement is 2-wire and load dependent. The ASP-22 option connects directly to the iTIG III high voltage leads as an alternate to the ATF-11 for span surge tests.



### ARP: Armature Resistance Probes

The ARP-02 is a 4-wire resistance probe set that measures the bar-to-bar resistance on armatures. Compatible with iTIG III models C and D with micro-Ohm measurement and multi-coil test feature.

# TESTING ACCESSORIES

Add accessories like a bar code scanner and foot switch for safe and easy operation.



### Bar Code Scanner

Scan barcodes for easy data input. Compatible with iTIG III Model B,C,D. Use with Model D PLTA-3 function.



### FS-12: Foot Switch

Use the FS-12 for hands-free operation. Compatible with all models of the iTIG III.



### Warning Lights

Safety first: Indicate when testing is underway for a safer workplace environment.

# iTIG III CONFIGURATIONS

The iTIG III is modular and configurable to meet your testing needs.



### Max Output Voltages:

4kV, 6kV, 12kV, 12kV-H, and 15kV-H  
(H indicates higher surge pulse discharge energy)

### Max Output Voltage with Power Pack III:

18kV, 24kV, 30kV, 40kV  
(See page 14-15 for Power Pack III specifications)

Key Features	Model			
	A	B	C	D
Surge Test	✓	✓	✓	✓
DC Hipot Test	✓	✓	✓	✓
Insulation Resistance	✓	✓	✓	✓
Reporting		✓	✓	✓
Winding Resistance (mΩ)		✓	✓	✓
Micro-ohm Winding Resistance			○	✓
Impedance/Inductance		○	○	○
Advanced Multi-Coil Tests		○	○	✓
Partial Discharge		○	○	○
Automatic IR & Hipot Tests			✓	✓
Fully Automatic Testing				✓
Production Line Automation				○

✓ = Included ○ = Option

# TESTS AND FAILURES

Many failure modes can be detected with the iTIG III using the following tests.

Tests	Failures											
	Surge	PD	DC Hipot	Step Voltage	IR	DAR	PI	Low R (μΩ)	C	L	Z	Phase Angle
Partial Discharge		✓										
Weak Turn Insulation	✓	✓										
Shorts turn-to-turn	✓						✓		✓	✓	✓	
Weak Ground Wall	✓	✓	✓	✓	✓	✓	✓					
Dielectric ground wall strength			✓	✓								
Dirty or moist windings			✓	✓	✓	✓		✓				
Phase unbalanced	✓						✓		✓	✓	✓	
Open coils	✓						✓		✓	✓	✓	
Reversed coils	✓								✓		✓	
Resistive motor lead connections							✓				✓	
Power cable faults	✓		✓	✓	✓	✓	✓		✓	✓		

# SPECIFICATIONS

Surge Test	4kV	6kV	12kV	12kV-H	15kV-H
Max Output Voltage	4 kV	6 kV	12 kV	12 kV	15kV
Pulse Repetition Rate	50 Hz	50 Hz	50 Hz	25 Hz	17 Hz
Surge Voltage Accuracy	10%	10%	10%	10%	10%
Discharge Capacitance	40 nF	40 nF	40 nF	100 nF	100 nF
Max Surge Energy	0.32 J	0.72 J	2.9 J	7.2 J	11.3 J

DC IR and Hipot					
Max Resistance	8 TΩ	12 TΩ	24 TΩ	24 TΩ	30 TΩ
Min Resistance	0.25 MΩ	0.25 MΩ	0.25 MΩ	0.25 MΩ	0.25 MΩ
Max Output Voltage	4 kV	6 kV	12 kV	12 kV	15kV
Voltage Accuracy	2%	2%	2%	2%	2%
Current Resolution	10 pA	10 pA	10 pA	10 pA	10 pA
Current Accuracy*	2%	2%	2%	2%	2%
Current Trip-out	10–2,000 μA	10–2,000 μA	10–2,000 μA	10–2,000 μA	10–2,000 μA

Winding Resistance					
Resolution (Model C & D)	1μΩ	1μΩ	1μΩ	1μΩ	1μΩ
Accuracy 100μΩ - 2kΩ	0.5% - 0.1%	0.5% - 0.1%	0.5% - 0.1%	0.5% - 0.1%	0.5% - 0.1%
Resolution (Model B)	1mΩ	1mΩ	1mΩ	1mΩ	1mΩ
Accuracy 1mΩ - 2kΩ	0.1%±0.5mΩ	0.1%±0.5mΩ	0.1%±0.5mΩ	0.1%±0.5mΩ	0.1%±0.5mΩ

Impedance					
Accuracy from 0.001 Ω to 2 MΩ	<1%	<1%	<1%	<1%	<1%

Inductance					
Accuracy from 0.01 mH to 20 H	<1%	<1%	<1%	<1%	<1%

Capacitance					
Accuracy from 0.1 nF to 10 mF	<1%	<1%	<1%	<1%	<1%

Power Properties					
Input Power (VAC)	100–240	100–240	100–240	100–240	100–240
Fuse Size (250V)	5A	5A	5A	5A	5A

\*Offset: ±0.4 nA (preliminary)

# POWER PACK III



The Power Pack III is compatible with most iTIG II & III-Series configurations and generations. Use the PP-III to boost outputs to 18kV, 24kV, 30kV and 40kV. The lightest and most portable power pack on the market is easy to use with automatic settings provided by the iTIG III via a low voltage communication cable. The PP III is built for the shop and the field with rugged, stackable cases for maximum space savings.

## Automated Tests

All models of the Power Pack III have an automatic surge test. For other tests, the Power Pack III has the same level of automation as the iTIG III model it is connected to. For example, hipot tests can be automatic with model C and D but not model A and B. See product configurations on page 12.



## Independent Calibration

The Power Pack III is calibrated independently of the iTIG III. This means that it can be added to an iTIG III at any time without the instruments coming back to the factory for calibration. It also means it can be used with multiple iTIG IIIs at the shop or in the field. This is a big cost saving for companies with multiple iTIG III motor testers.

### Power Pack III Dimensions and Weight

	18-30kV	40kV
Dimensions (cm)	54 x 23 x 55 cm	54 x 28 x 66 cm
Dimensions (in.)	21 x 9 x 22 in.	21 x 11 x 26 in.
Weight (lbs.)	49 lbs.	83 lbs.
Weight (kg)	22 kg	37 kg



### Power Pack III Specifications

Surge Test	18-30kV	40kV
Max Output Voltage	18-30 kV	40 kV
Pulse Repetition Rate	5 Hz	2.5 Hz
Surge Voltage Accuracy	10%	10%
Discharge Capacitance	100 nF	150 nF
Max Surge Energy	45 J	120 J
DC IR and Hi-pot		
Max Output Voltage*	18-30 kV	40 kV
Voltage Accuracy*	2%	2%
Current Resolution	0.01 $\mu$ A	0.01 $\mu$ A
Current Accuracy	2%	2%
Current Trip-out	10-2,000 $\mu$ A	10-2,000 $\mu$ A
Power Properties		
Input Power (VAC)	100-240	100-240
Fuse Size (250V)	5A	5A

\*Use the iTIG III for test voltages up to the instrument's max voltage before using Power Pack III



Electrom provides world-class customer service  
from our headquarters in Longmont, Colorado.



Get in touch for legacy product support, product  
rentals, consulting, and one-on-one training.  
We always answer the phone.



1844 Nelson Rd Unit B  
Longmont, CO 80501

800-833-1881  
+1 720-491-3580  
info@electrominst.com

[www.electrominst.com](http://www.electrominst.com)